



US0D1069124S

(12) **United States Design Patent** (10) **Patent No.:** **US D1,069,124 S**  
**Schraven et al.** (45) **Date of Patent:** **\*\* Apr. 1, 2025**

(54) **PATIENT SUPPORT TABLE**

(71) Applicant: **KONINKLIJKE PHILIPS N.V.**,  
Eindhoven (NL)

(72) Inventors: **Eckhardt Henricus Matheus**  
**Schraven**, Boxtel (NL); **Yan Zhuang**,  
Shanghai (CN)

(73) Assignee: **KONINKLIJKE PHILIPS N.V.**,  
Eindhoven (NL)

(\*\*) Term: **15 Years**

(21) Appl. No.: **29/795,024**

(22) Filed: **Jun. 16, 2021**

(51) **LOC (15) Cl.** ..... **24-02**

(52) **U.S. Cl.**  
USPC ..... **D24/183**

(58) **Field of Classification Search**  
USPC ..... D24/107, 158–161, 183–184, 200, 201;  
D6/336–337, 382, 383, 384, 392, 393,  
D6/595–596, 601, 604–605, 718  
(Continued)

(56) **References Cited**

**U.S. PATENT DOCUMENTS**

D553,246 S \* 10/2007 Banryu ..... D24/183  
D727,509 S \* 4/2015 Tan ..... D24/159  
(Continued)

**FOREIGN PATENT DOCUMENTS**

IN 245854 \* 4/2013

**OTHER PUBLICATIONS**

MRI. Online, published date unknown. Retrieved on Dec. 26, 2023  
from URL: <https://www.kpmhealth.com/core/e01/?lang=en>\*

*Primary Examiner* — Omeed Agilee

(57) **CLAIM**

The ornamental design for a patient support table as shown  
and described.

**DESCRIPTION**

FIG. 1 is a perspective view of a first embodiment of a  
patient support table;  
FIG. 2 is a front elevational view thereof;  
FIG. 3 is a rear elevational view thereof;  
FIG. 4 is a right side elevational view thereof;  
FIG. 5 is a left side elevational view thereof;  
FIG. 6 is a top plan view thereof;  
FIG. 7 is a bottom plan view thereof;  
FIG. 8 is a perspective view of a second embodiment of the  
patient support table;  
FIG. 9 is a front elevational view thereof;  
FIG. 10 is a rear elevational view thereof;  
FIG. 11 is a right side elevational view thereof;  
FIG. 12 is a left side elevational view thereof;  
FIG. 13 is a top plan view thereof;  
FIG. 14 is a bottom plan view thereof.  
FIG. 15 is a perspective view of a third embodiment of the  
patient support table;  
FIG. 16 is a front elevational view thereof;  
FIG. 17 is a rear elevational view thereof;  
FIG. 18 is a right side elevational view thereof;  
FIG. 19 is a left side elevational view thereof;  
FIG. 20 is a top plan view thereof;  
FIG. 21 is a bottom plan view thereof;  
FIG. 22 is a perspective view of a fourth embodiment of the  
patient support table;  
FIG. 23 is a front elevational view thereof;  
FIG. 24 is a rear elevational view thereof;  
FIG. 25 is a right side elevational view thereof;  
FIG. 26 is a left side elevational view thereof;  
FIG. 27 is a top plan view thereof;  
FIG. 28 is a bottom plan view thereof;  
FIG. 29 is a perspective view of a fifth embodiment of the  
patient support table;  
FIG. 30 is a front elevational view thereof;  
FIG. 31 is a rear elevational view thereof;  
FIG. 32 is a right side elevational view thereof;

(Continued)

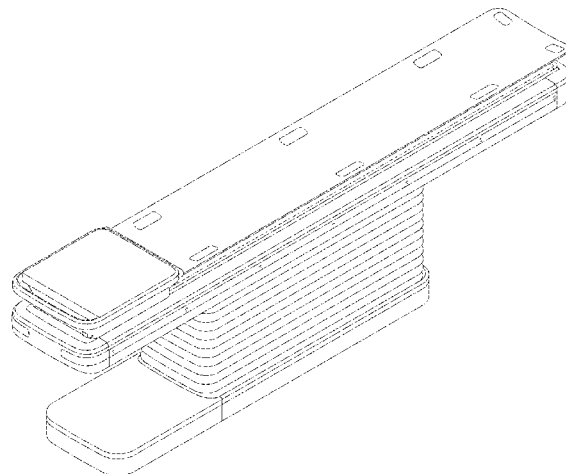

FIG. 33 is a left side elevational view thereof;  
 FIG. 34 is a top plan view thereof;  
 FIG. 35 is a bottom plan view thereof;  
 FIG. 36 is a perspective view of a sixth embodiment of the patient support table;  
 FIG. 37 is a front elevational view thereof;  
 FIG. 38 is a rear elevational view thereof;  
 FIG. 39 is a right side elevational view thereof;  
 FIG. 40 is a left side elevational view thereof;  
 FIG. 41 is a top plan view thereof;  
 FIG. 42 is a bottom plan view thereof;  
 FIG. 43 is a perspective view of a seventh embodiment of the patient support table;  
 FIG. 44 is a front elevational view thereof;  
 FIG. 45 is a rear elevational view thereof;  
 FIG. 46 is a right side elevational view thereof;  
 FIG. 47 is a left side elevational view thereof;  
 FIG. 48 is a top plan view thereof;  
 FIG. 49 is a bottom plan view thereof;  
 FIG. 50 is a perspective view of an eighth embodiment of the patient support table;  
 FIG. 51 is a front elevational view thereof;  
 FIG. 52 is a rear elevational view thereof;  
 FIG. 53 is a right side elevational view thereof;  
 FIG. 54 is a left side elevational view thereof;  
 FIG. 55 is a top plan view thereof; and,  
 FIG. 56 is a bottom plan view thereof.

The broken lines depict portions of the patient support table that form no part of the claimed design.

**1 Claim, 48 Drawing Sheets**

(58) **Field of Classification Search**  
 CPC ..... A61M 16/101; A61H 1/00; A61G 13/10;  
 A61G 13/1235; A61G 2210/50; A61B  
 6/04; A61B 6/0407; A61B 6/0487; A61F  
 5/3723; A61F 5/3761  
 See application file for complete search history.

(56) **References Cited**

U.S. PATENT DOCUMENTS

D735,864	S	*	8/2015	Doerre .....	D24/159
D736,934	S	*	8/2015	Kim .....	D24/183
D748,804	S	*	2/2016	Eenboom .....	D24/183
D770,049	S	*	10/2016	Yanagihara .....	D24/159
D829,913	S	*	10/2018	Kitayama .....	D24/159
D843,583	S	*	3/2019	Roth .....	D24/159
D844,789	S	*	4/2019	Hetz .....	D24/183
D855,185	S	*	7/2019	Chang .....	D24/159
D861,870	S	*	10/2019	Chang .....	D24/159
D895,809	S	*	9/2020	Morreale .....	D24/183
D911,528	S	*	2/2021	Sun .....	D24/183
D921,201	S	*	6/2021	Fasoli .....	D24/159
D967,964	S	*	10/2022	Boehner .....	D24/183
D967,965	S	*	10/2022	Dennert .....	D24/183
D970,733	S	*	11/2022	Guegel-Wild .....	D24/183
D972,733	S	*	12/2022	Smith .....	D24/183
D978,356	S	*	2/2023	Achleitner .....	D24/183
2009/0022280	A1	*	1/2009	Loser .....	A61B 5/055 378/209

\* cited by examiner

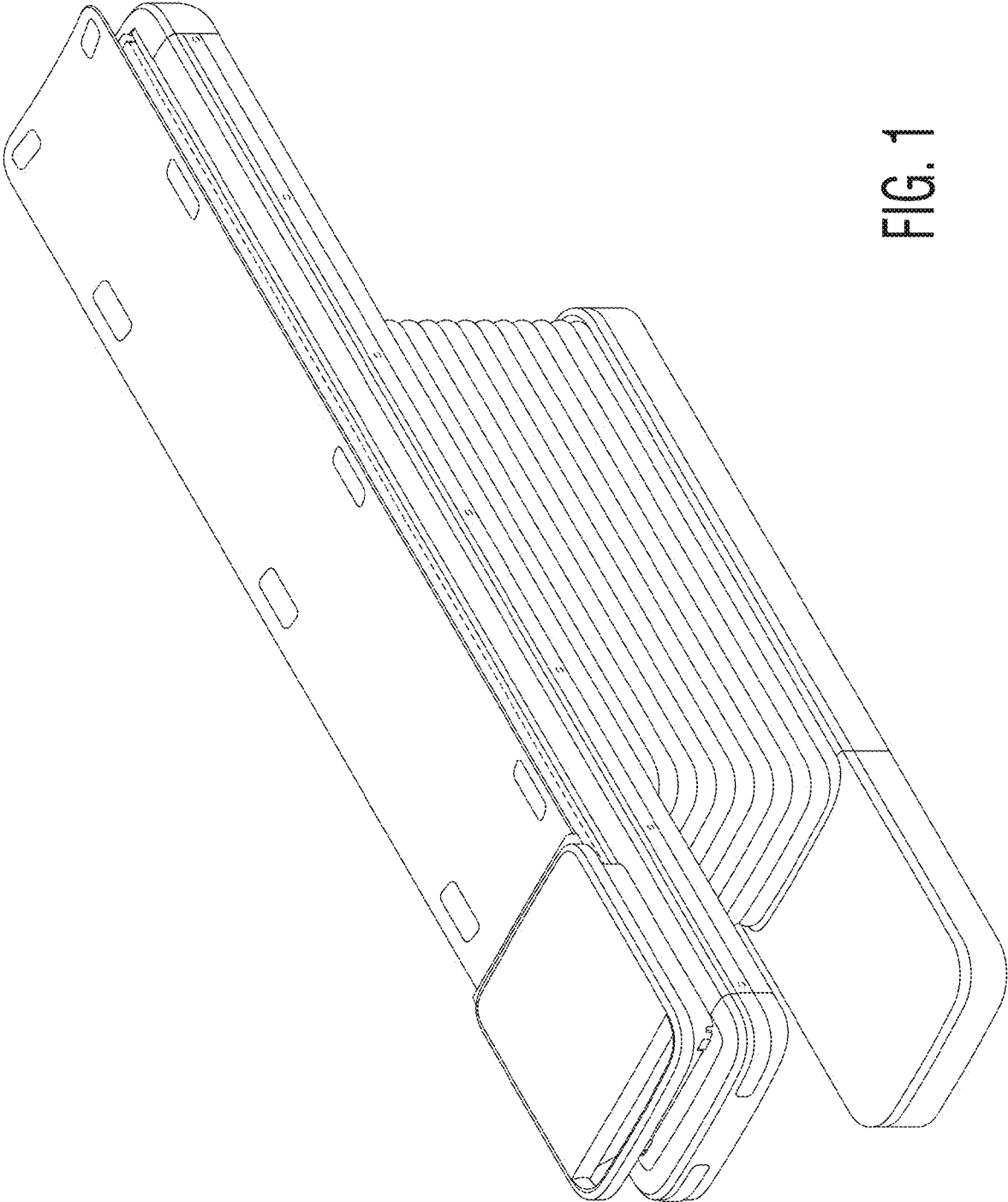

FIG. 1

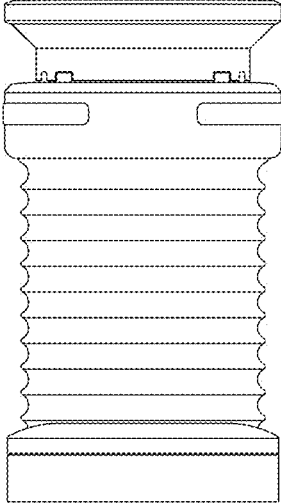

FIG. 2

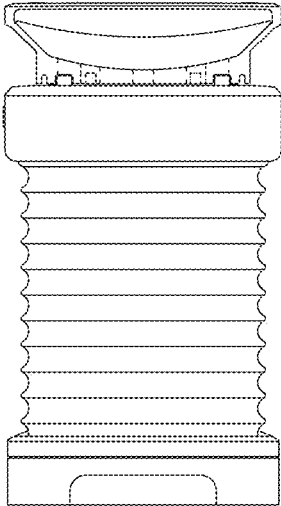

FIG. 3

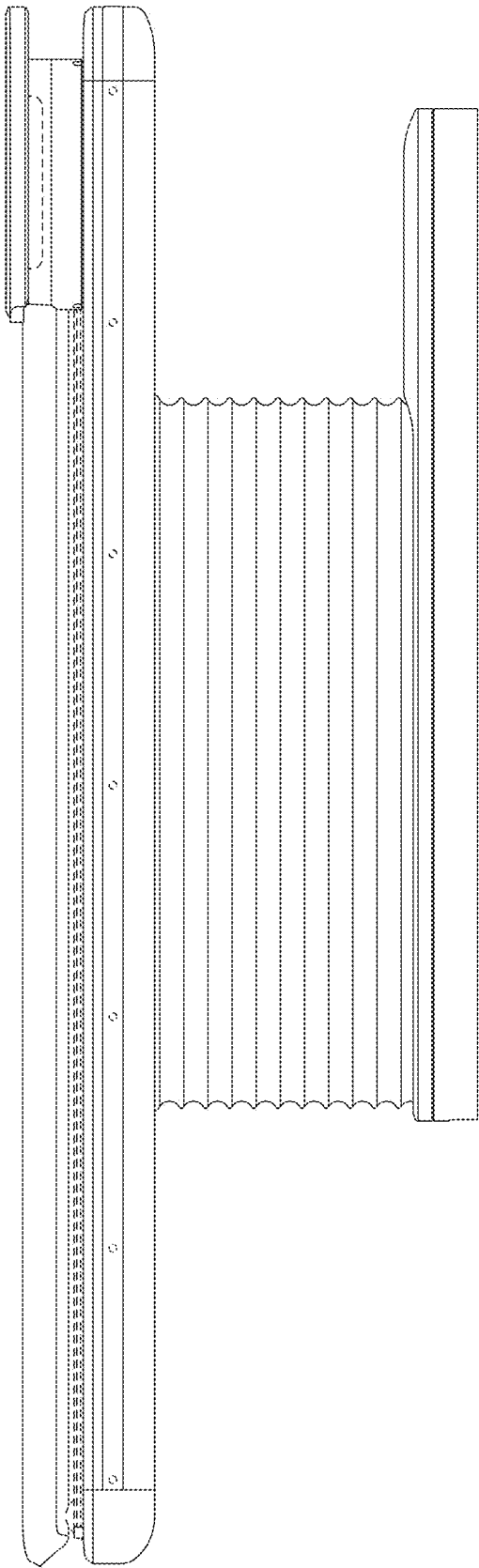

FIG. 4

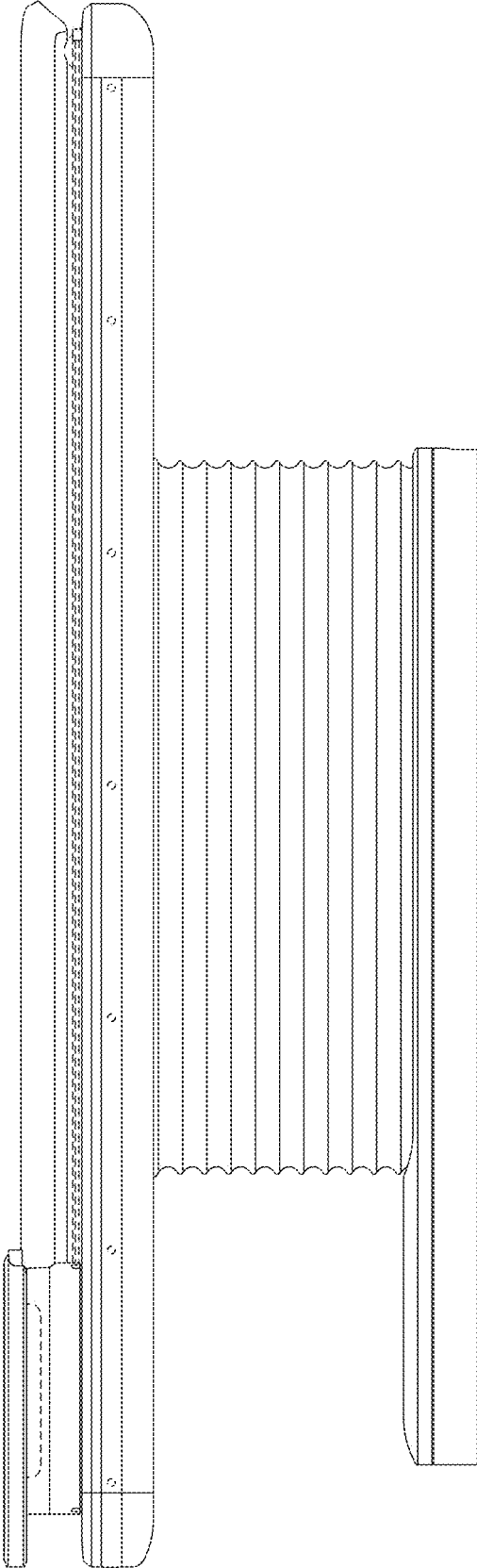

FIG. 5

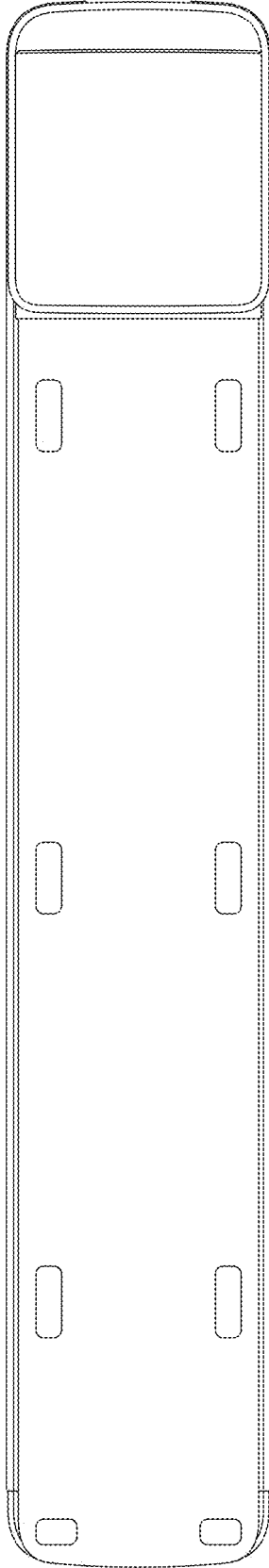

FIG. 6

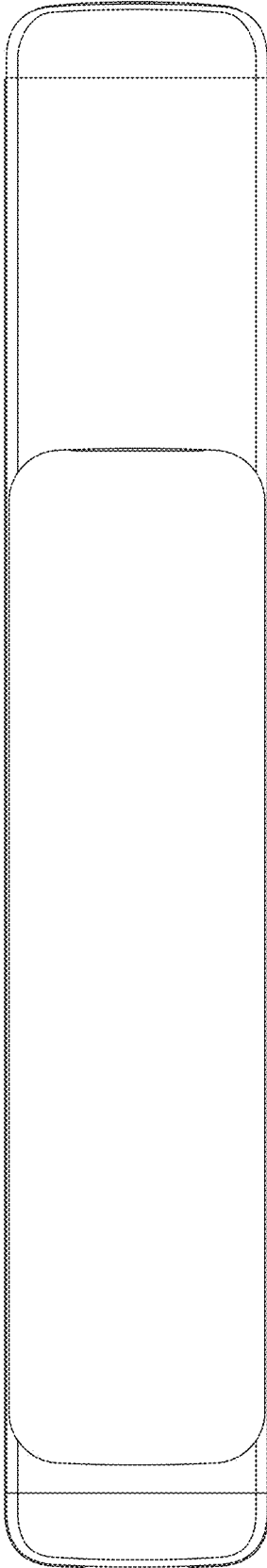

FIG. 7

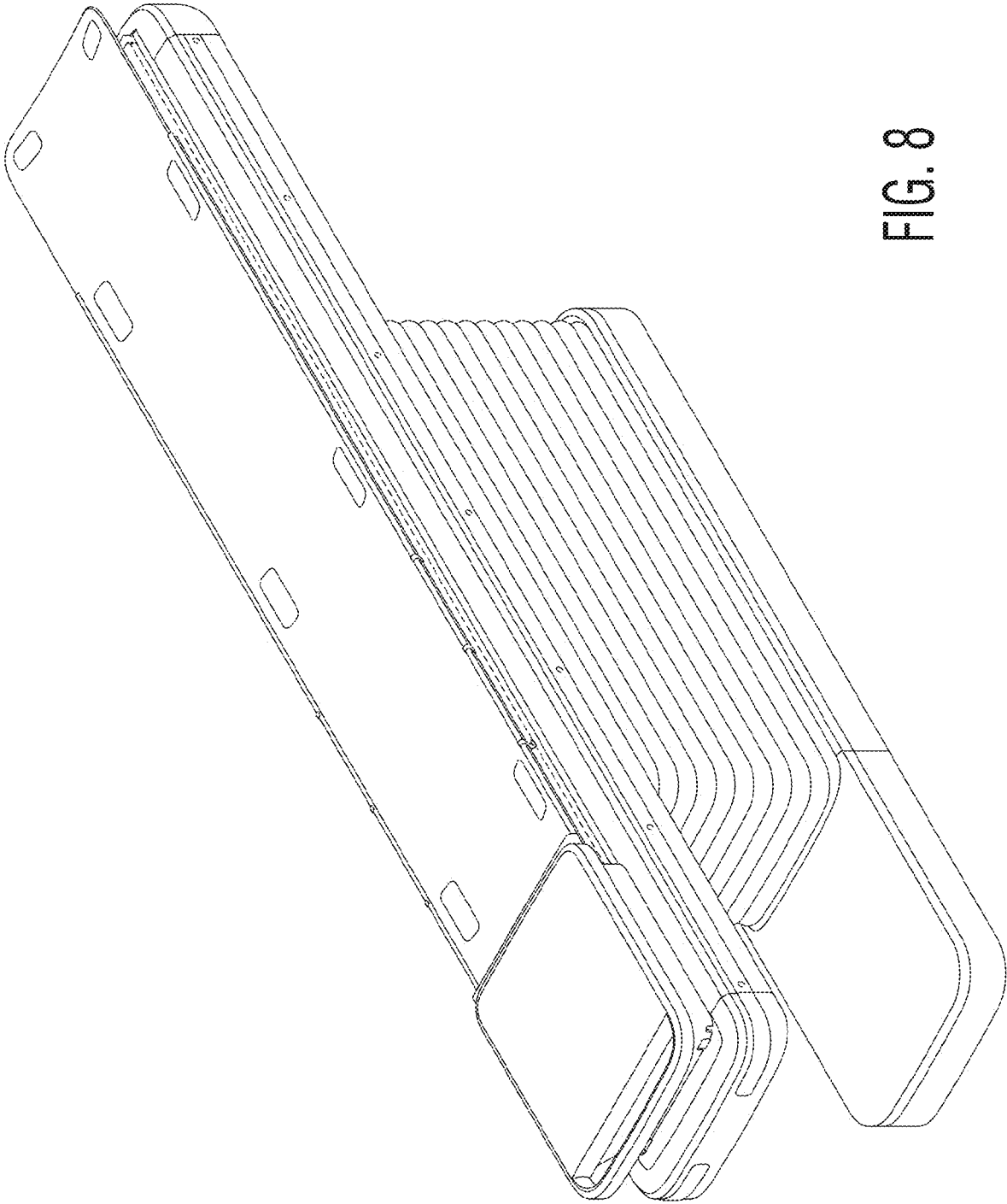

FIG. 8

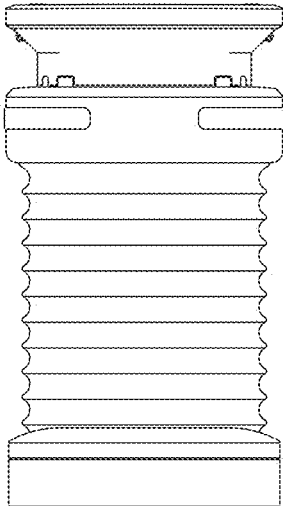

FIG. 9

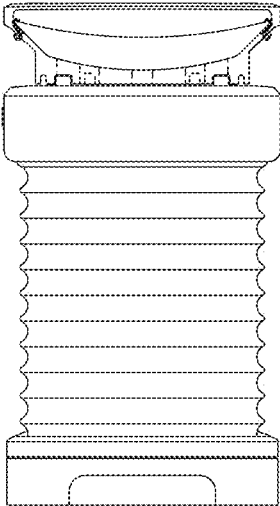

FIG. 10

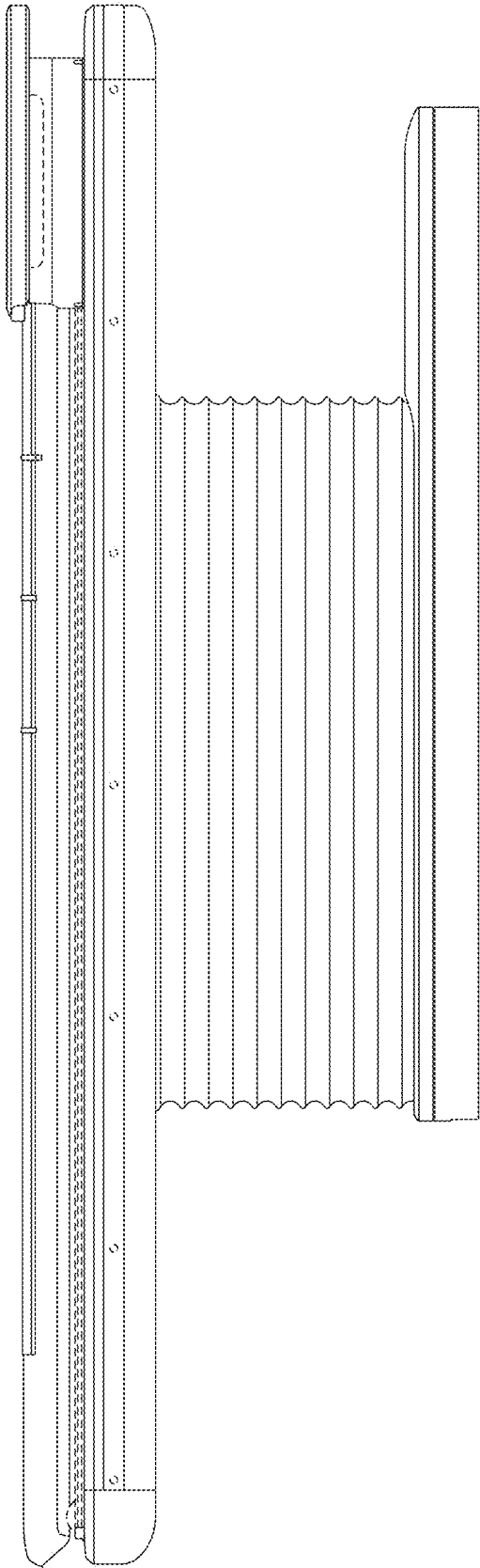

FIG. 11

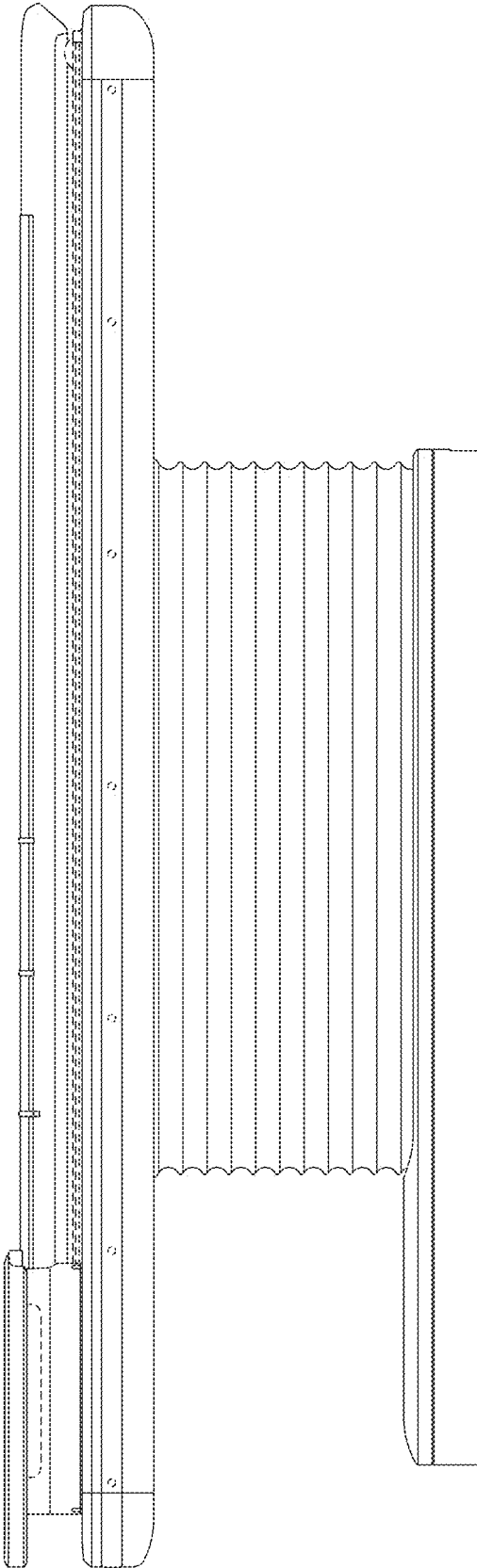

FIG. 12

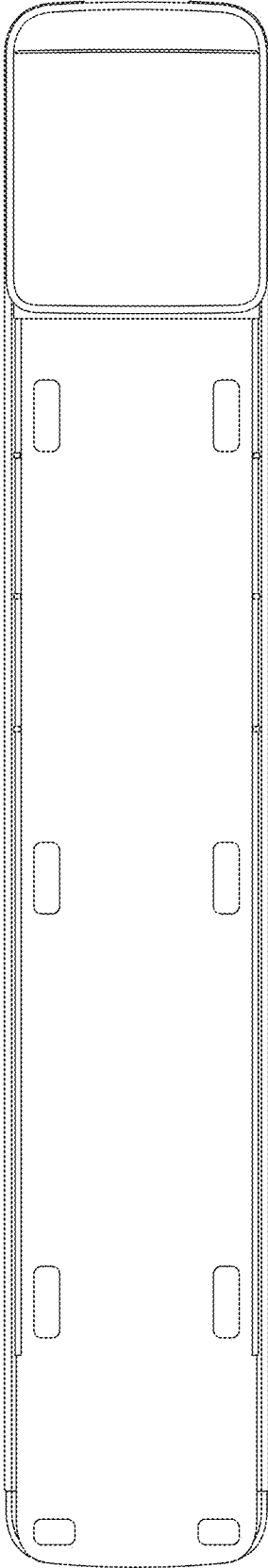

FIG. 13

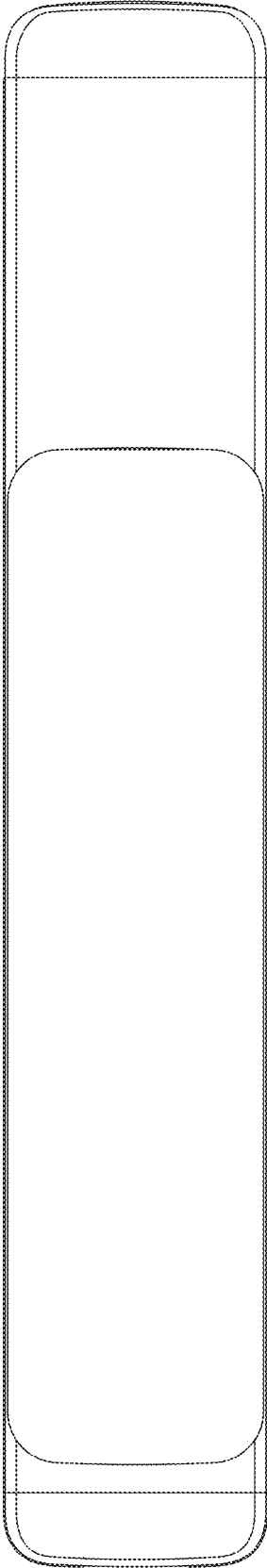

FIG. 14

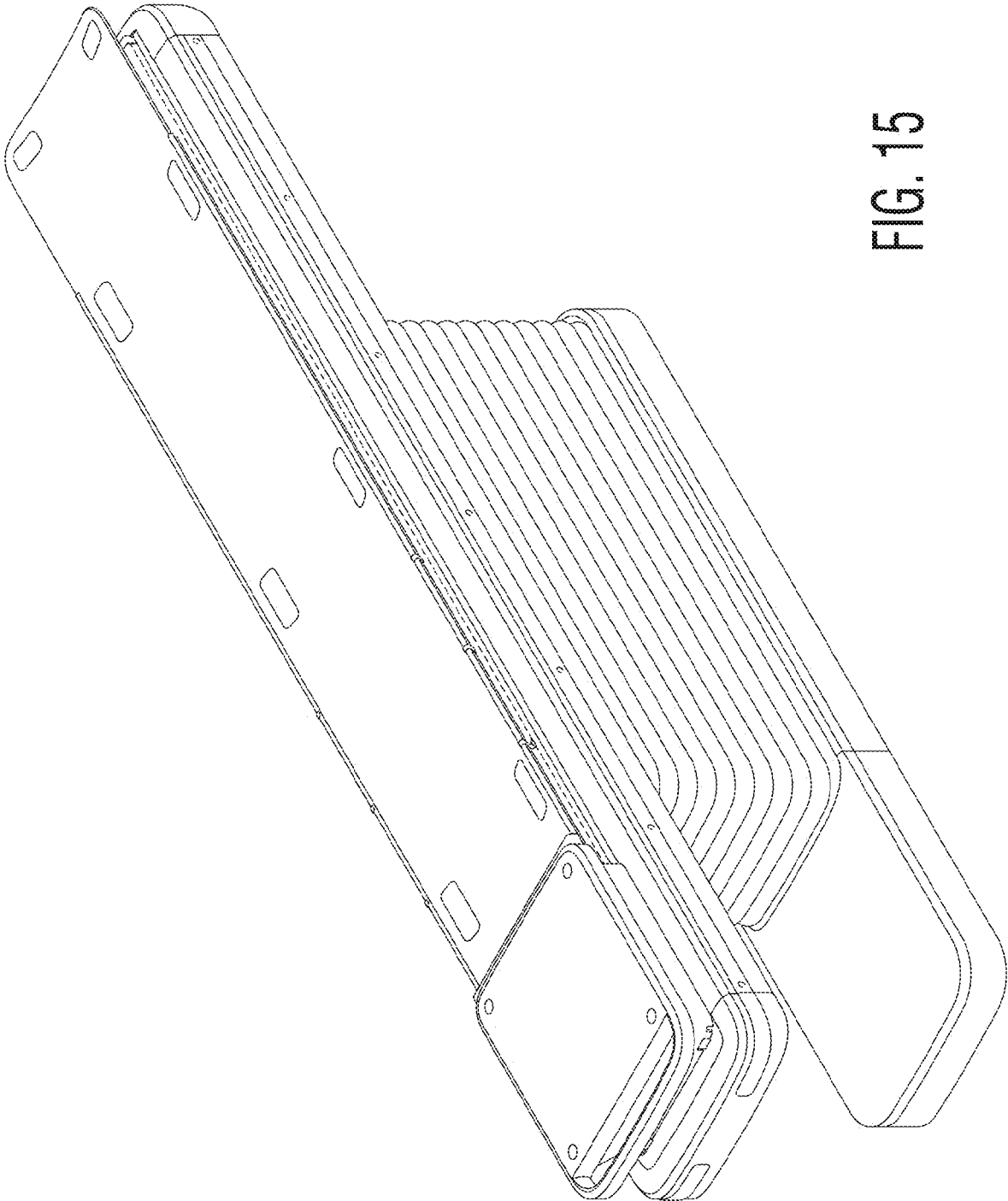

FIG. 15

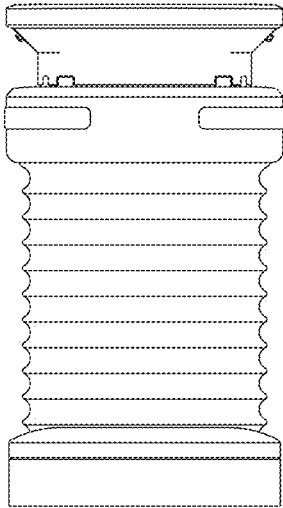

FIG. 16

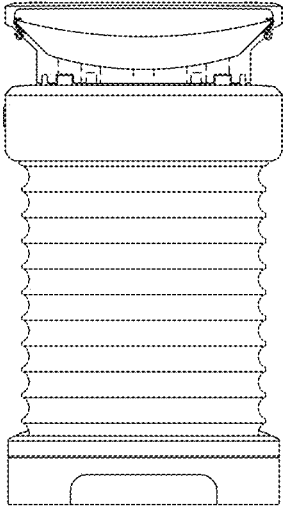

FIG. 17

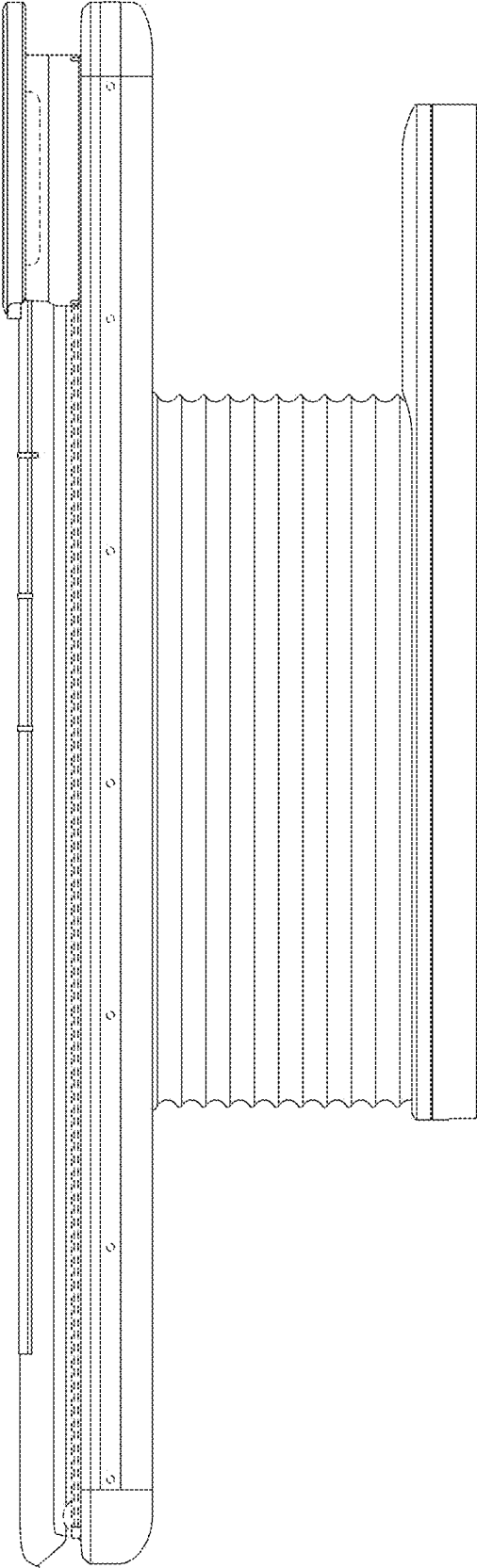

FIG. 18

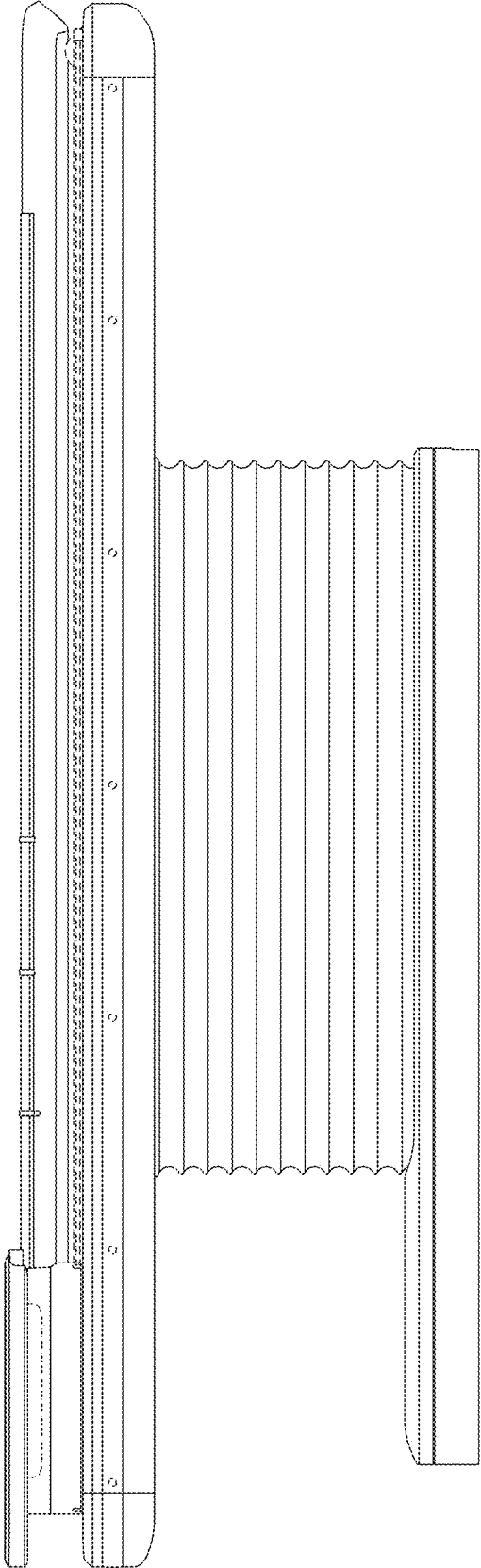

FIG. 19

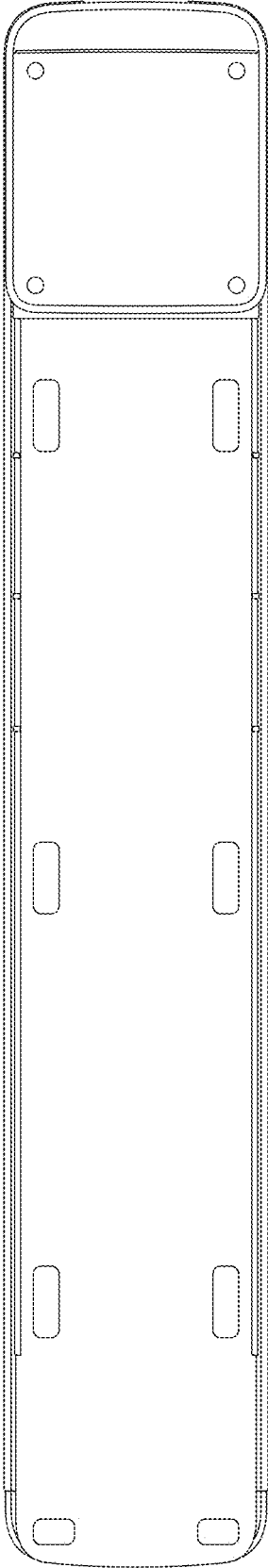

FIG. 20

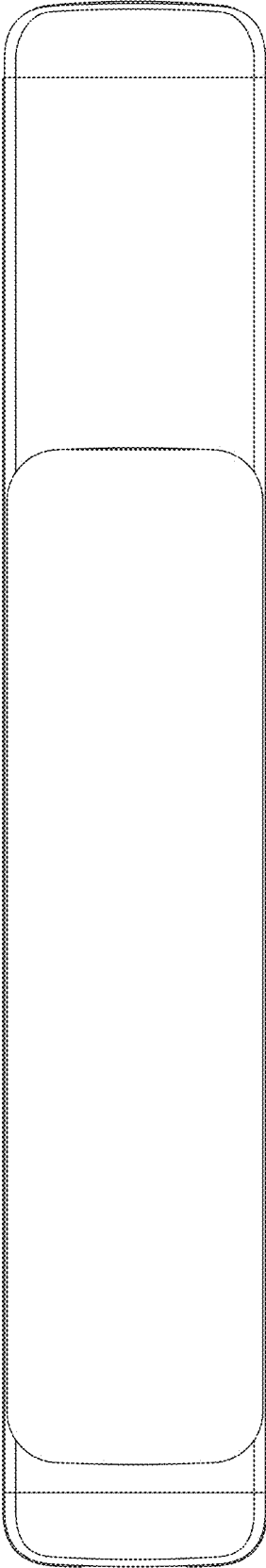

FIG. 21

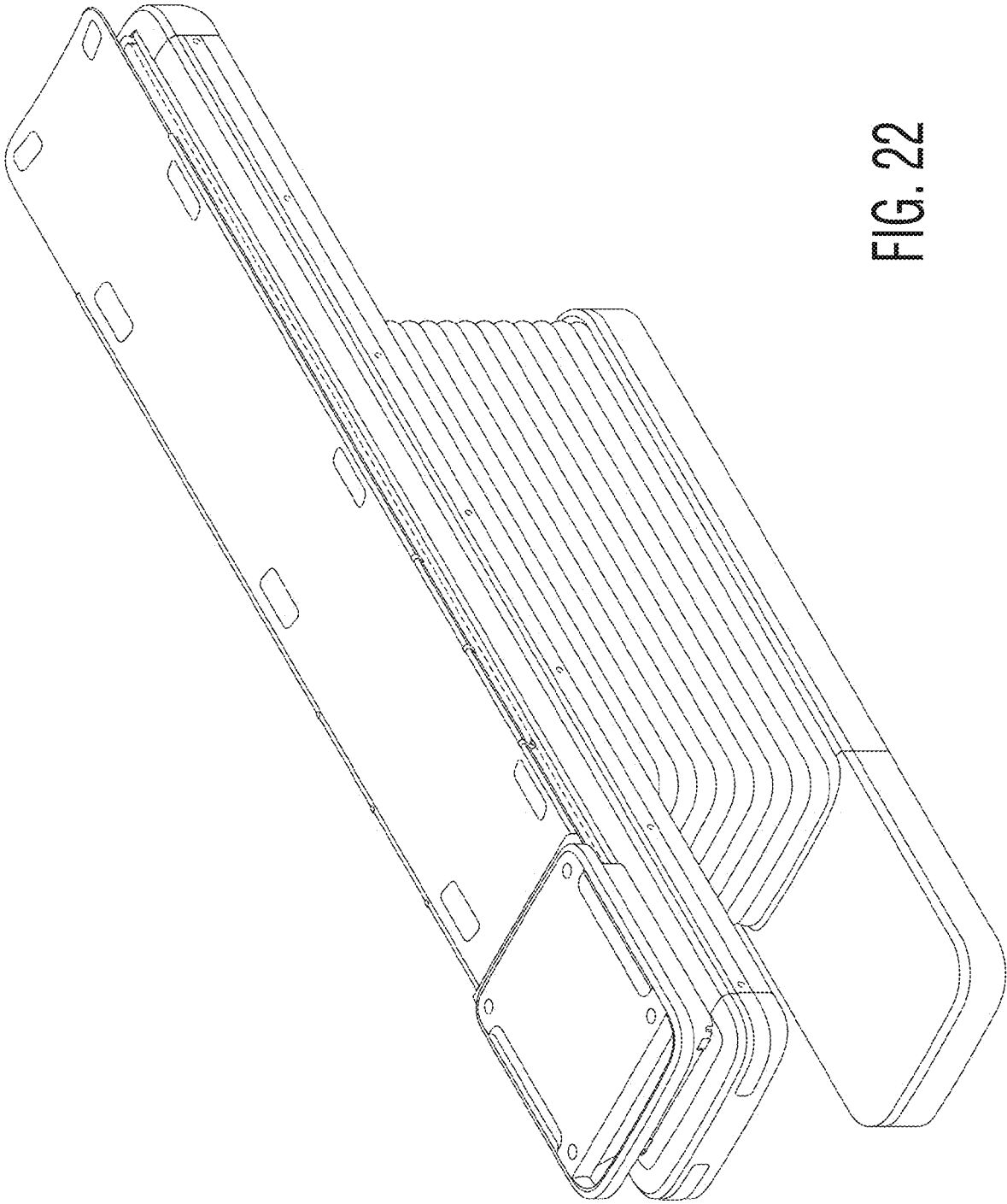

FIG. 22

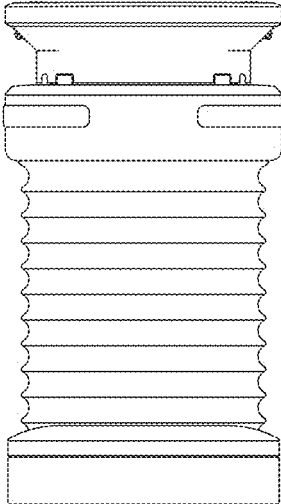

FIG. 23

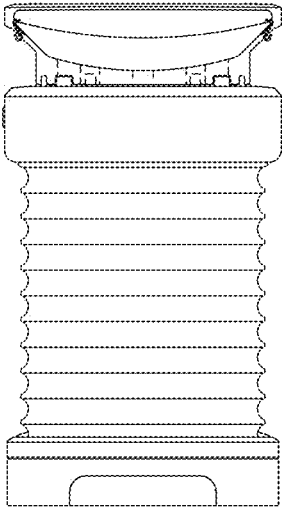

FIG. 24

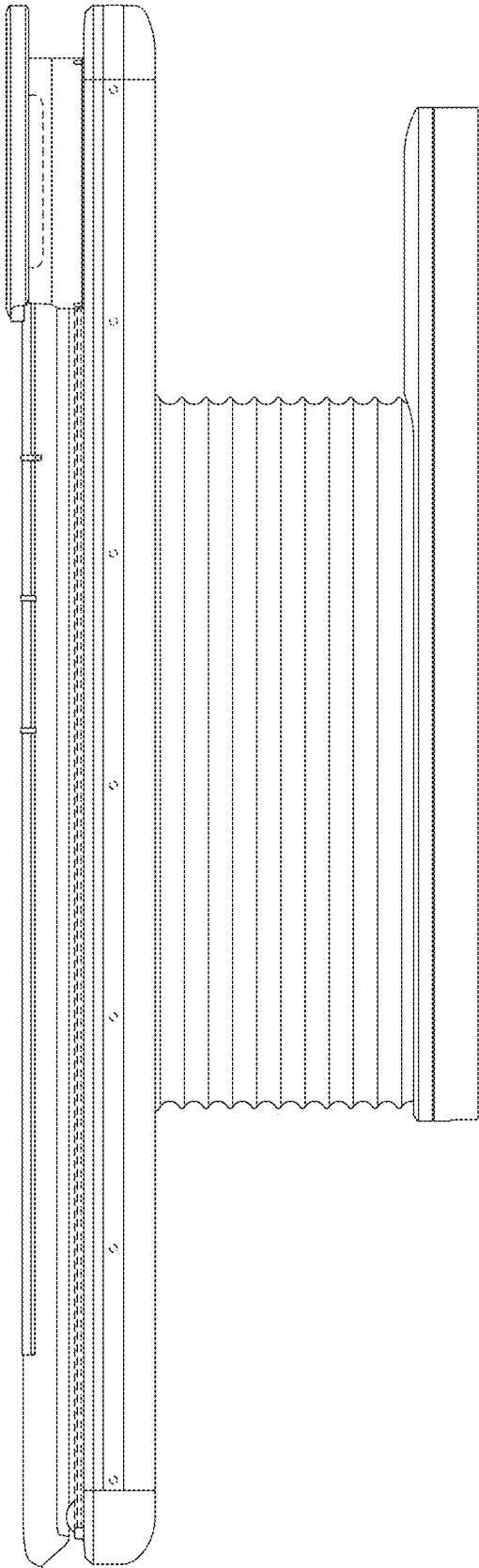

FIG. 25

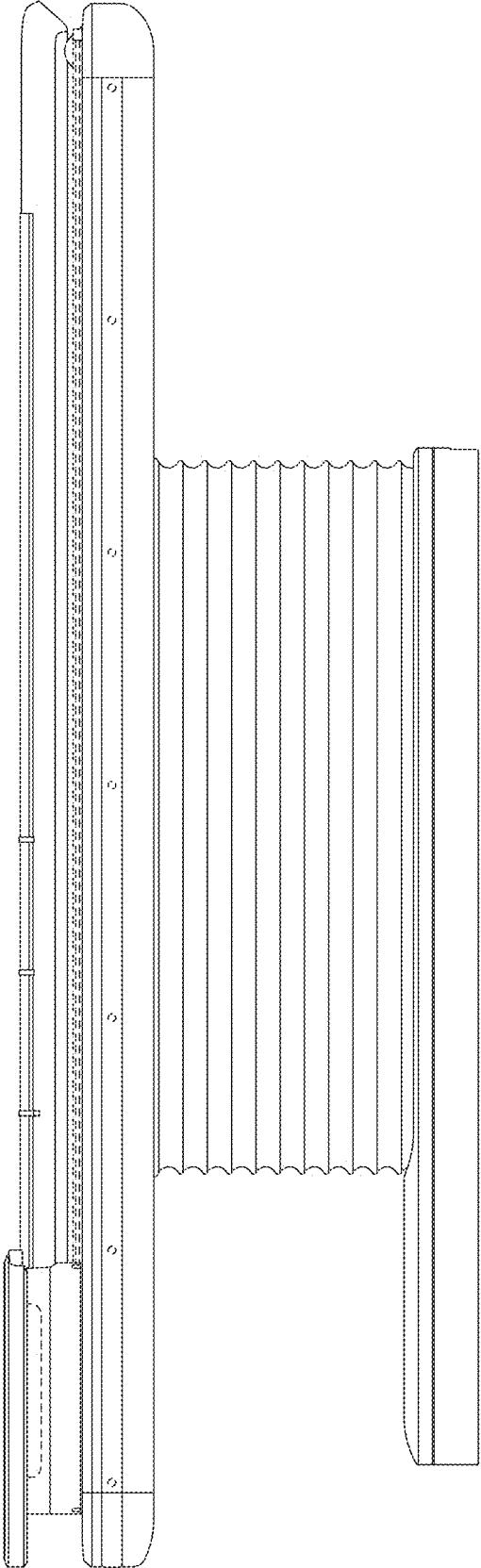

FIG. 26

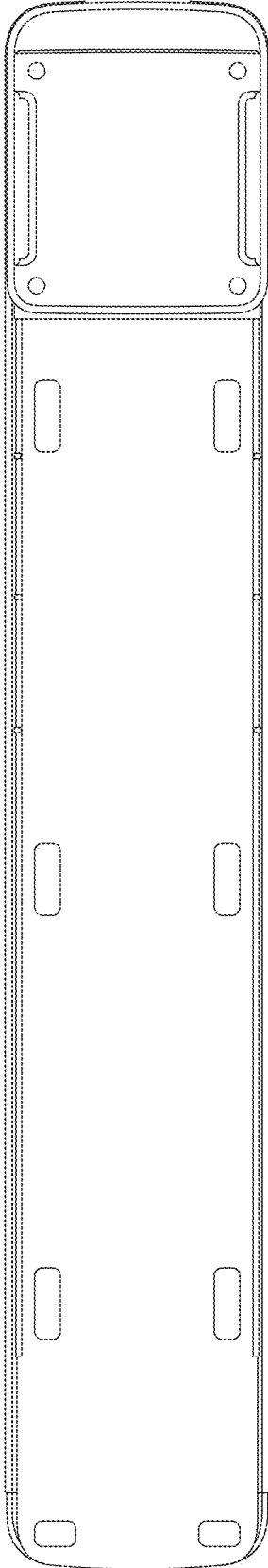

FIG. 27

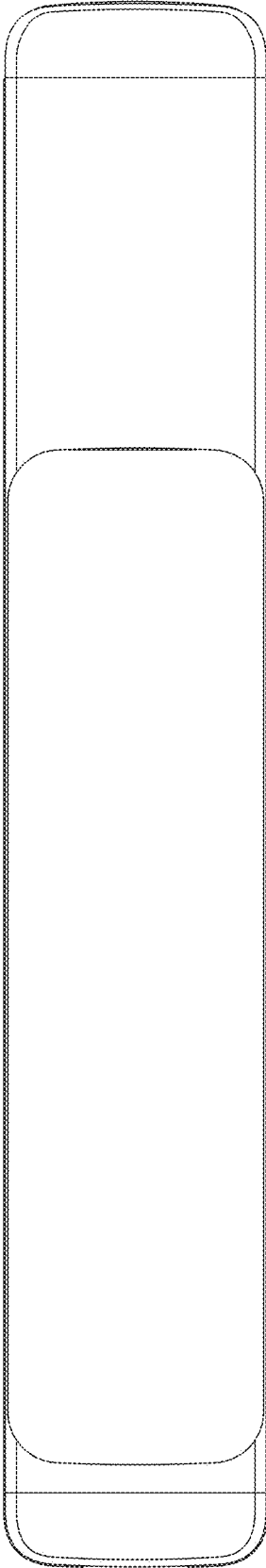

FIG. 28

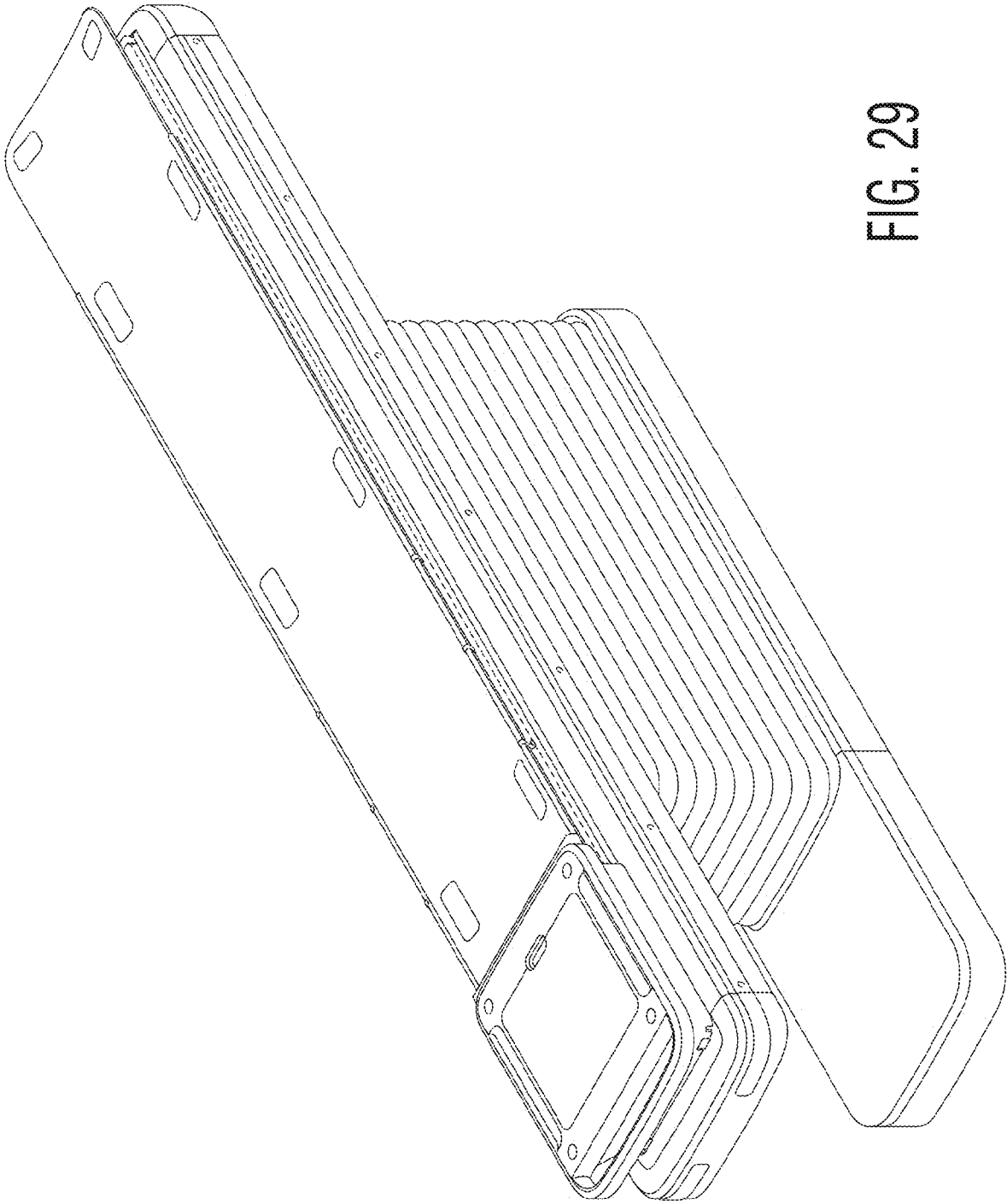

FIG. 29

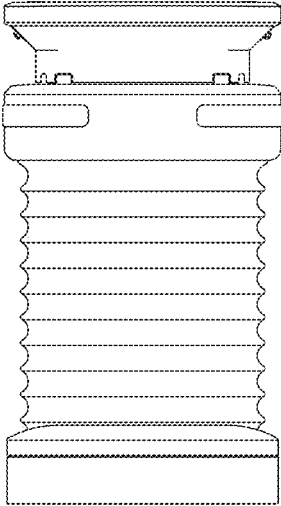

FIG. 30

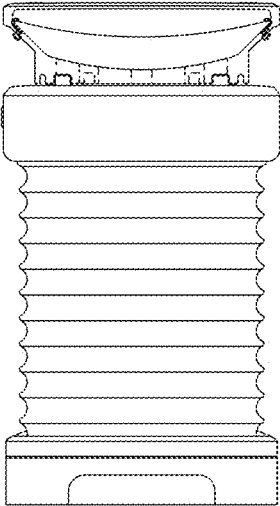

FIG. 31

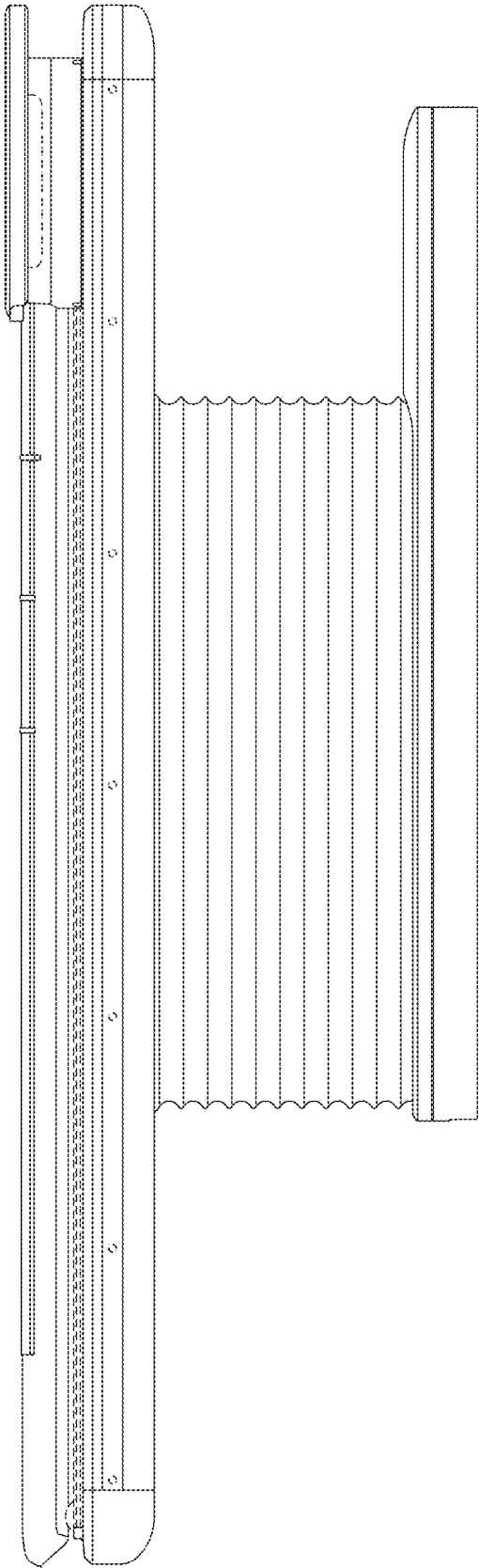

FIG. 32

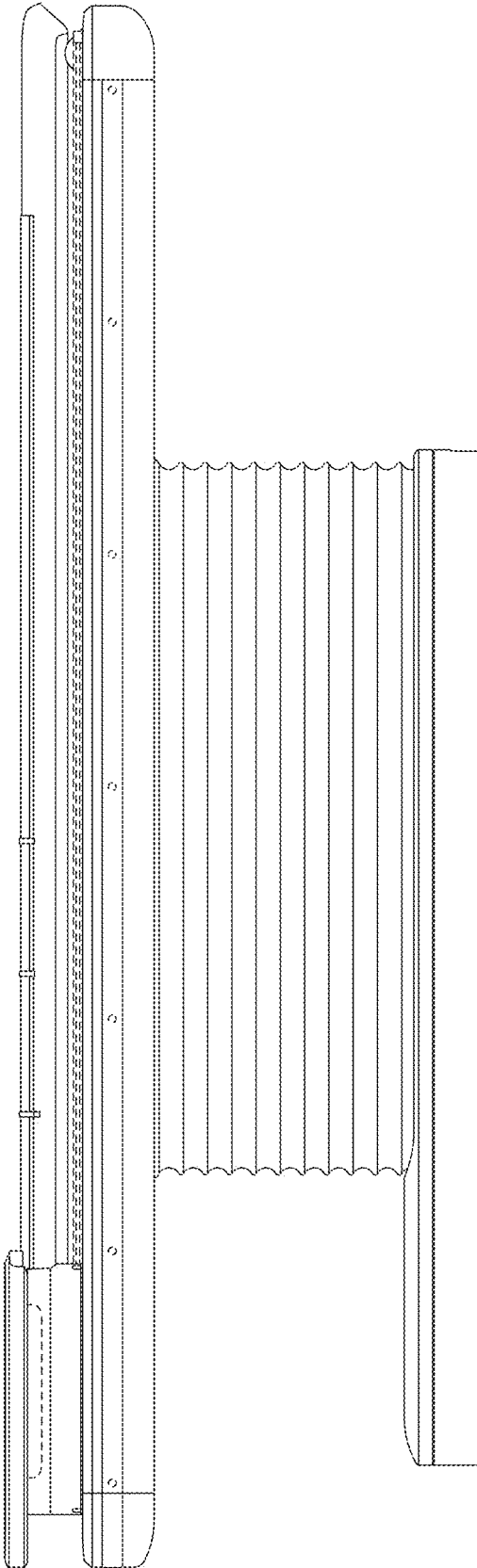

FIG. 33

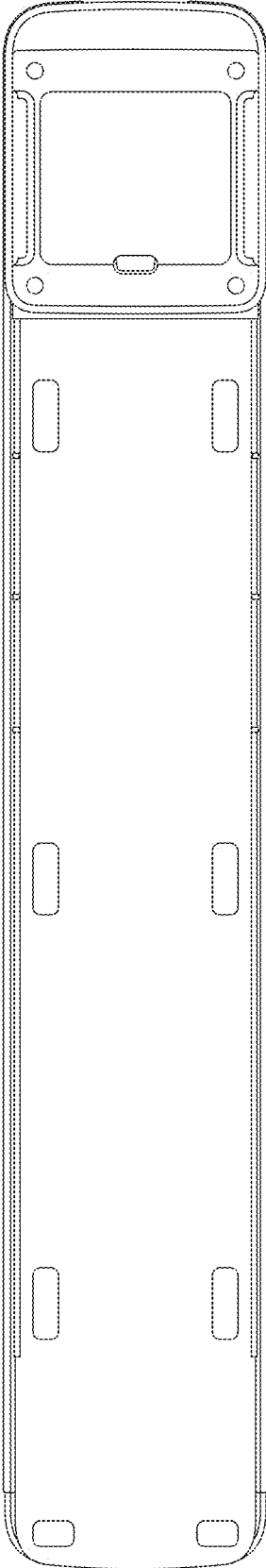

FIG. 34

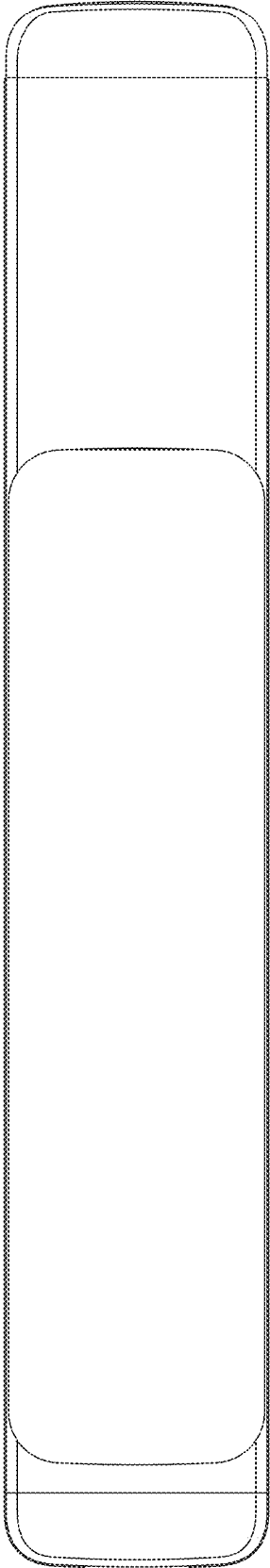

FIG. 35

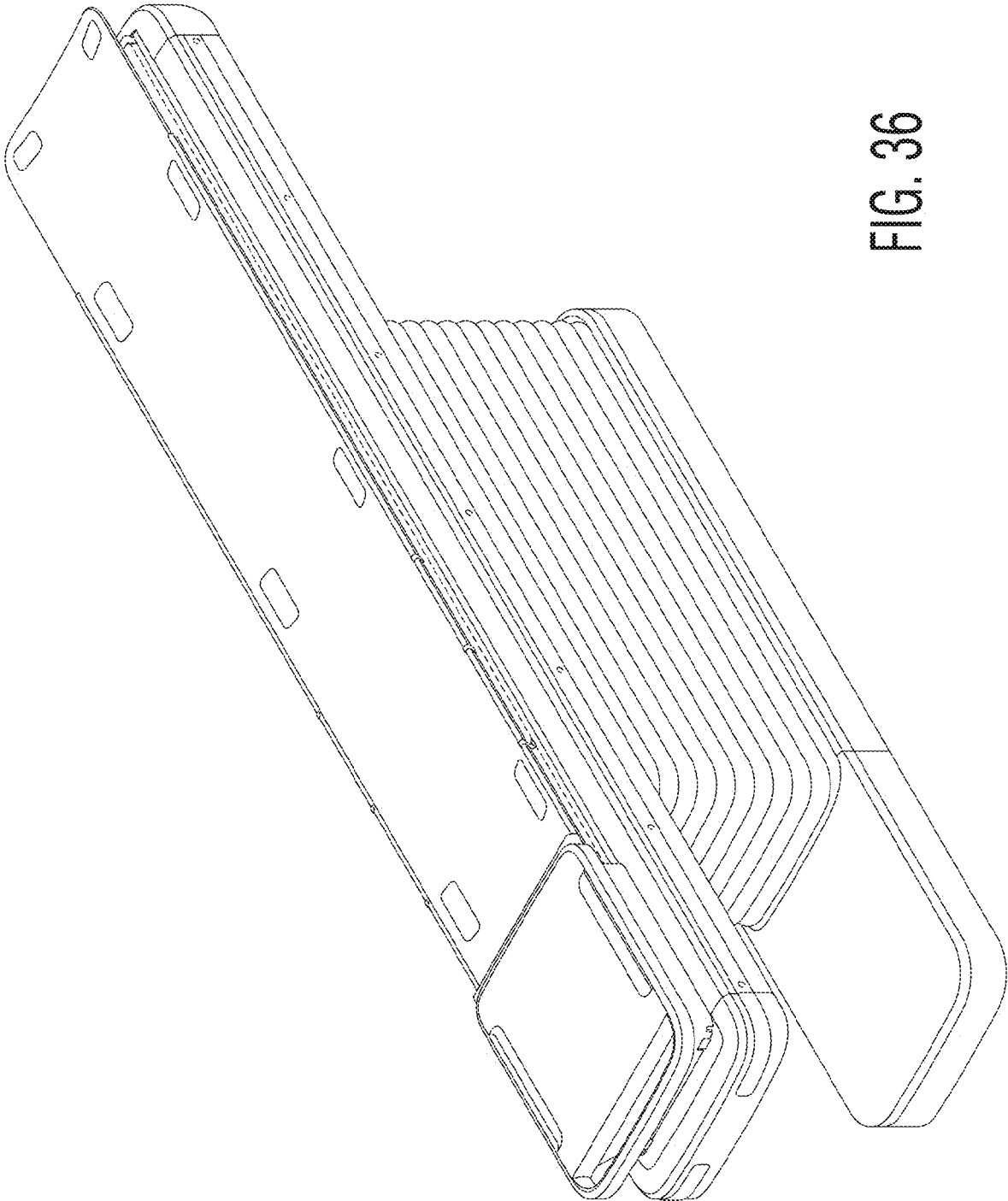

FIG. 36

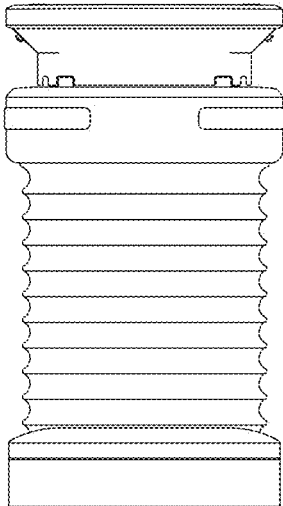

FIG. 37

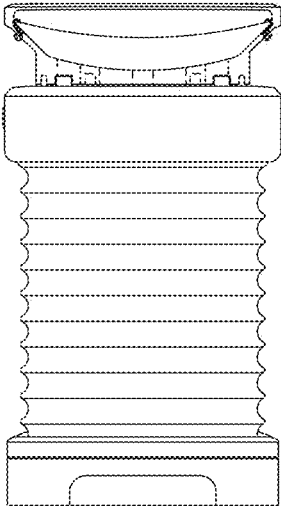

FIG. 38

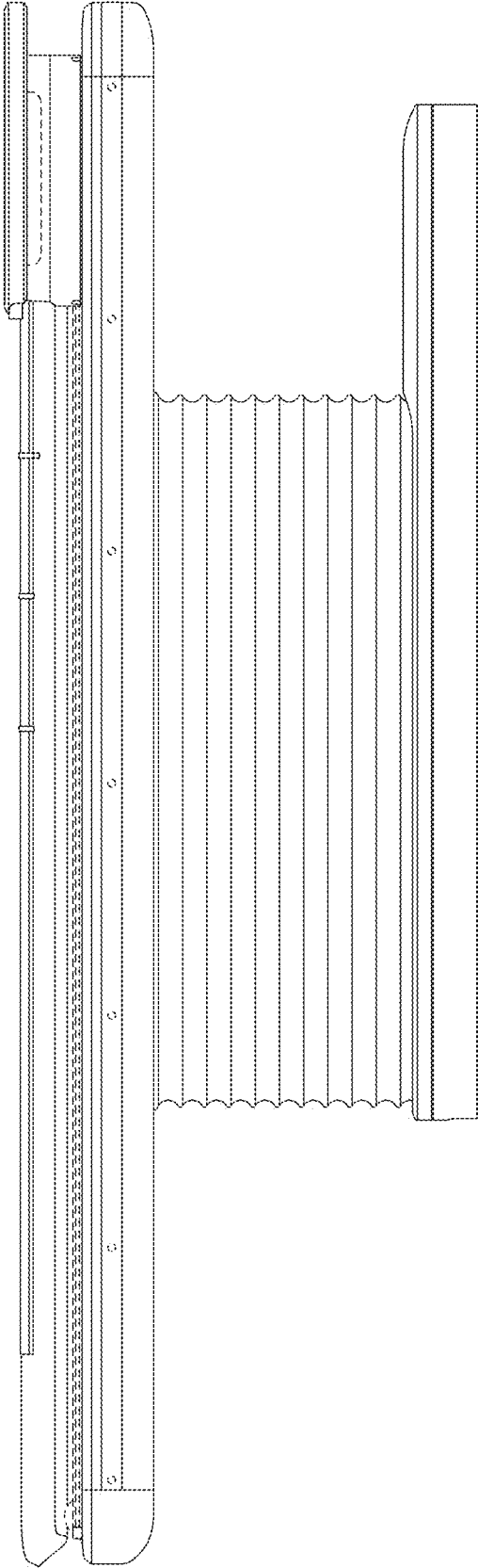

FIG. 39

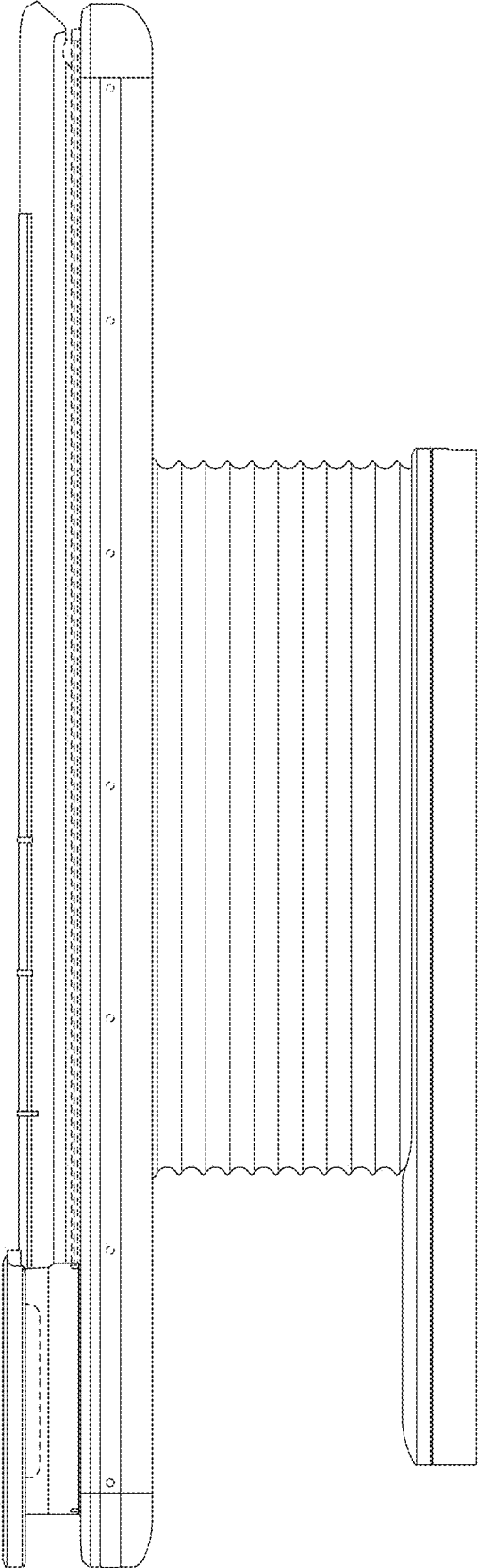

FIG. 40

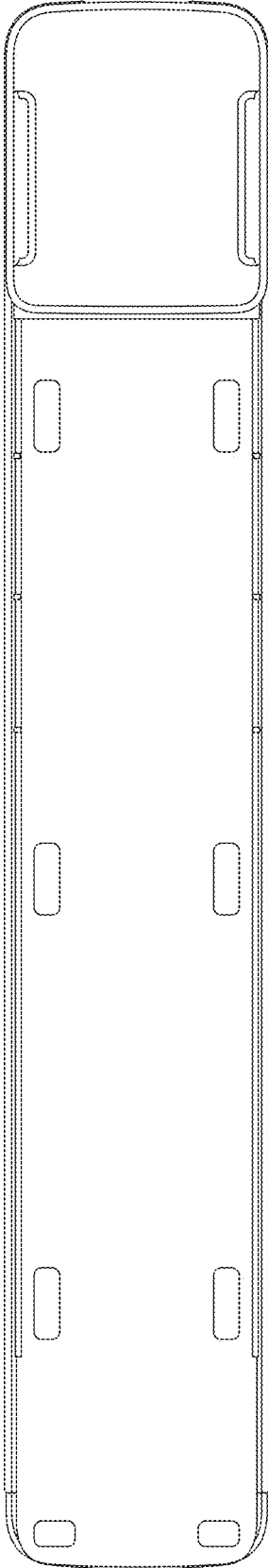

FIG. 41

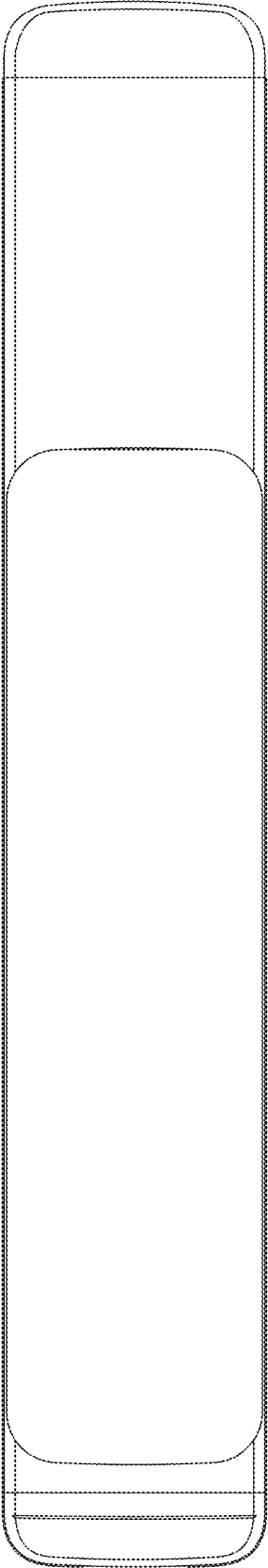

FIG. 42

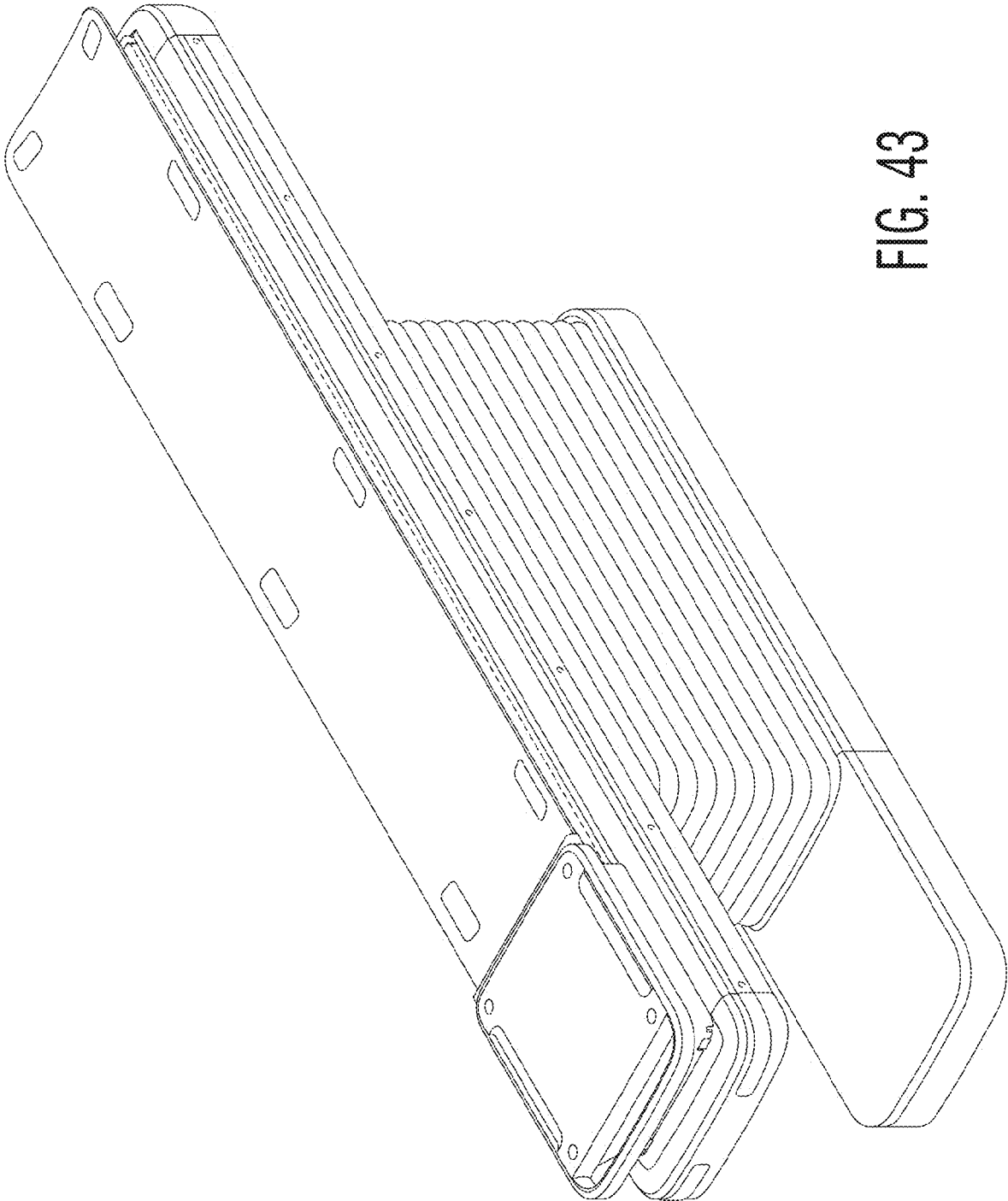

FIG. 43

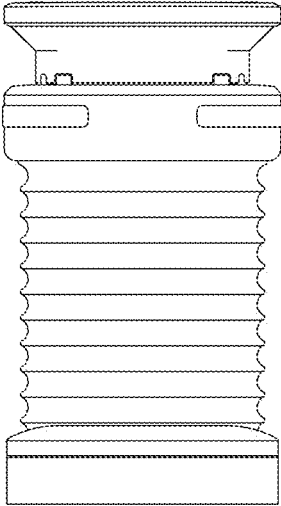

FIG. 44

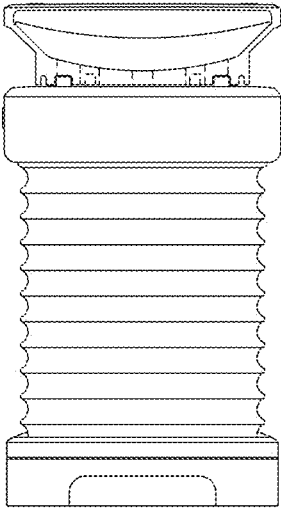

FIG. 45

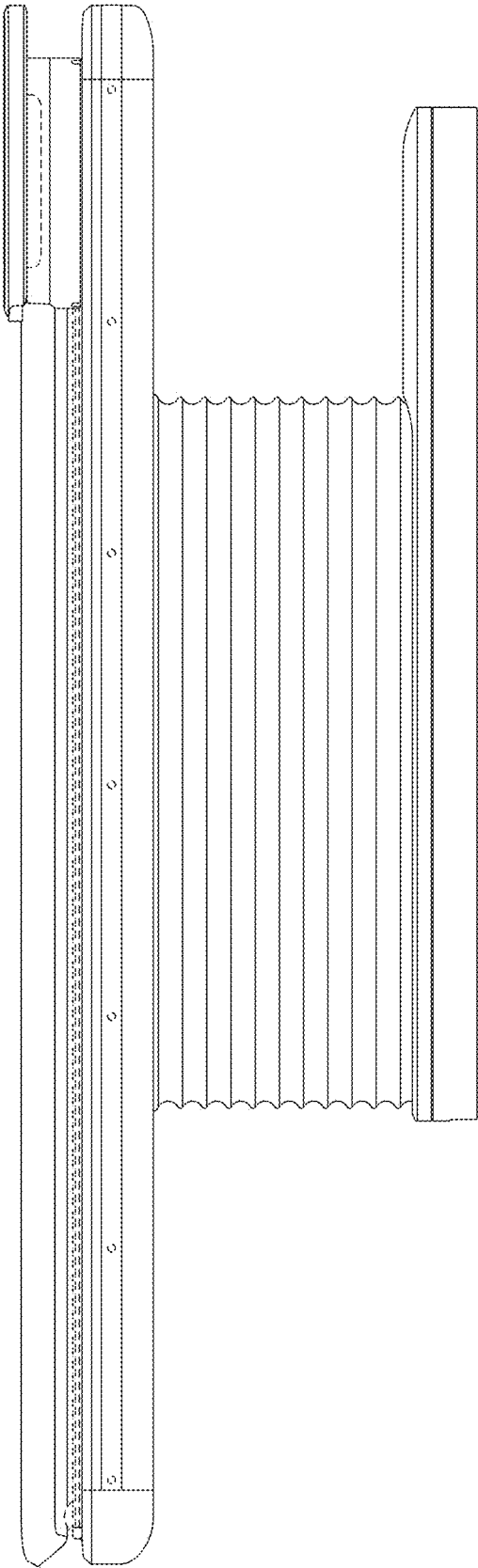

FIG. 46

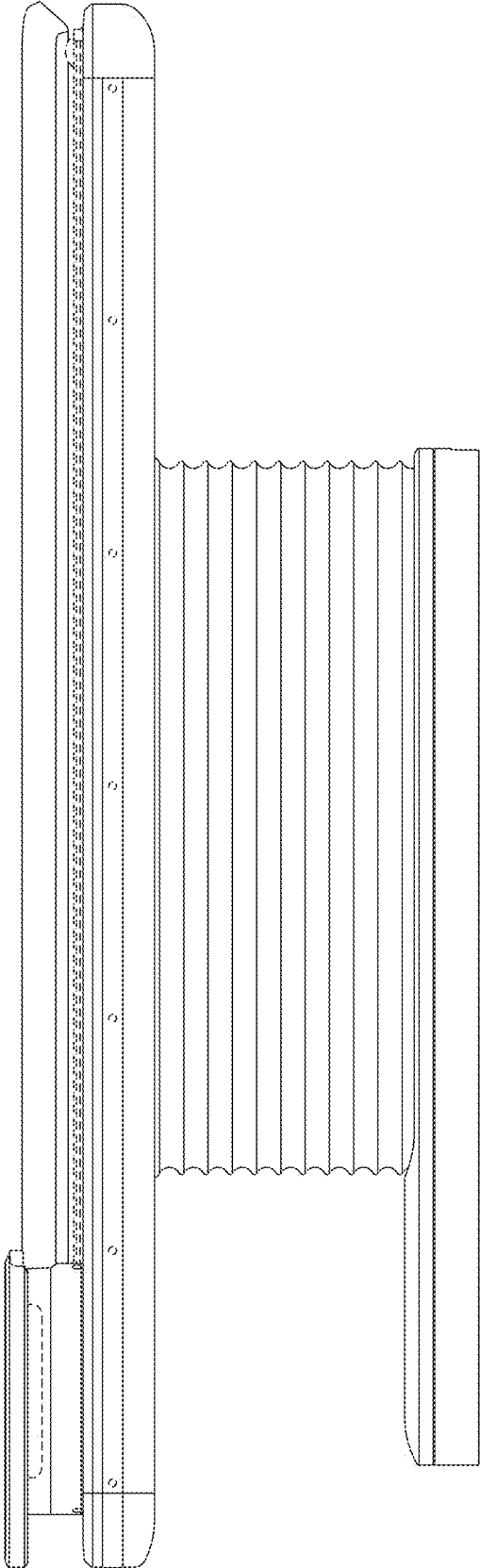

FIG. 47

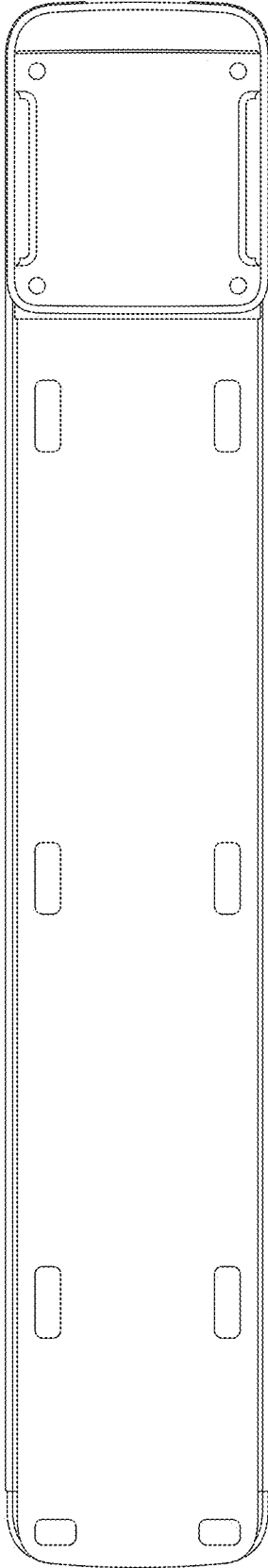

FIG. 48

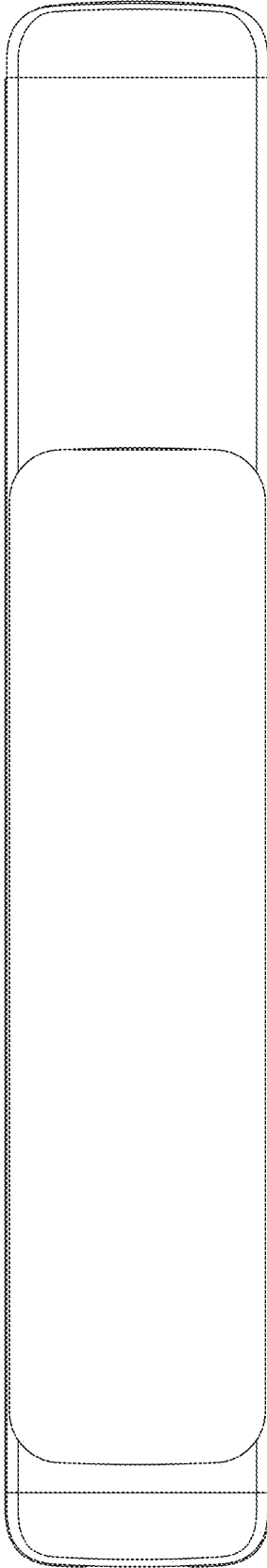

FIG. 49

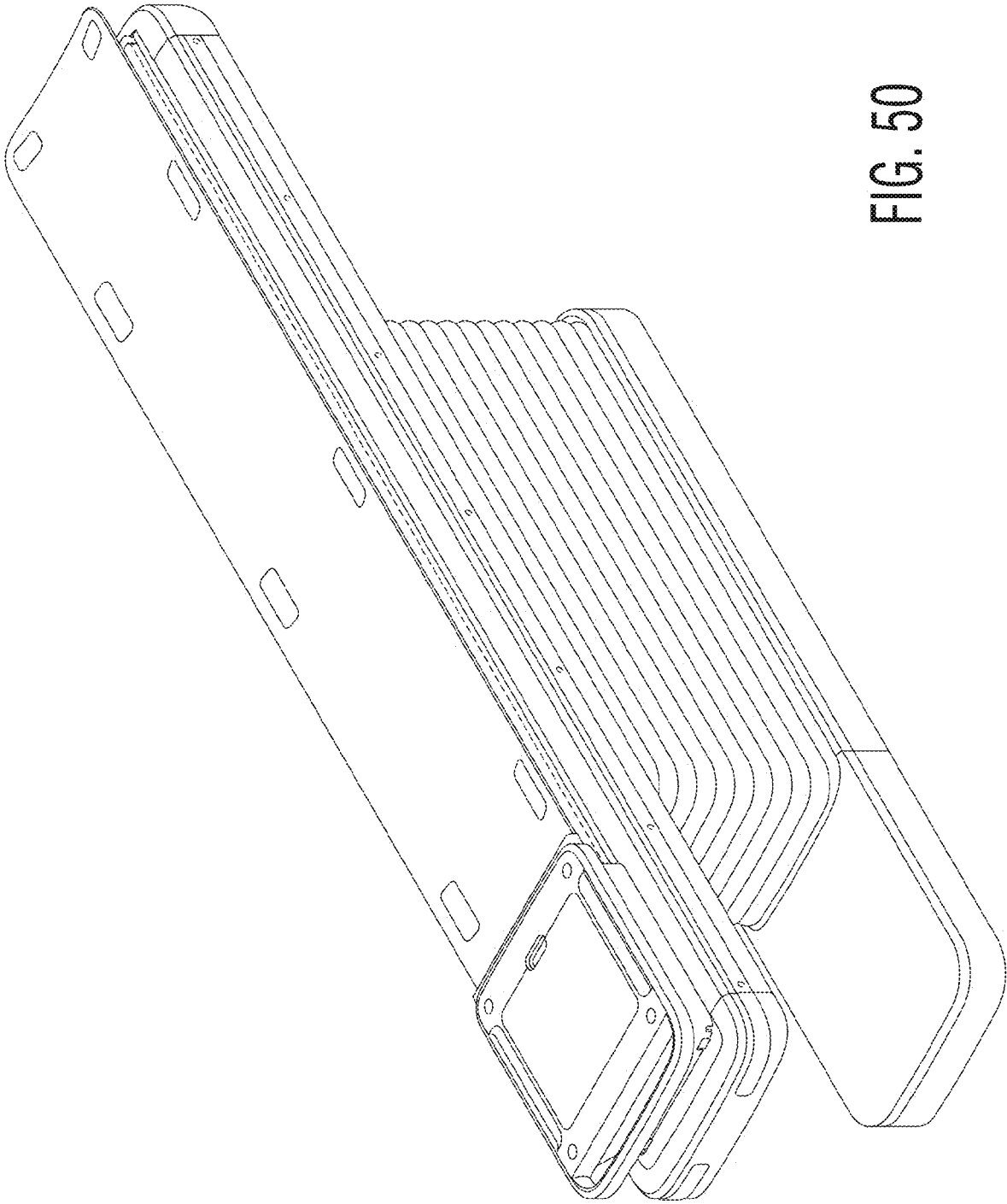

FIG. 50

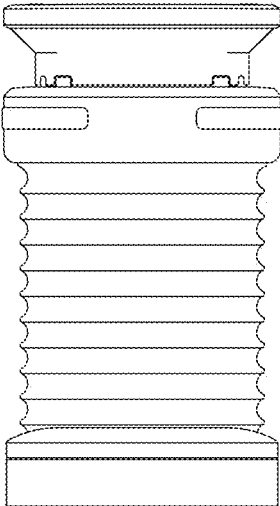

FIG. 51

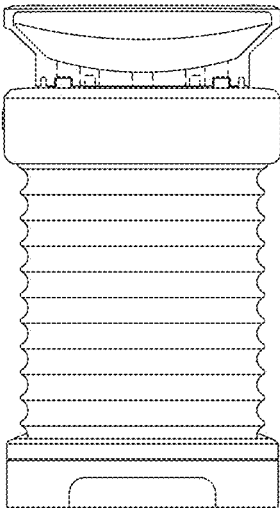

FIG. 52

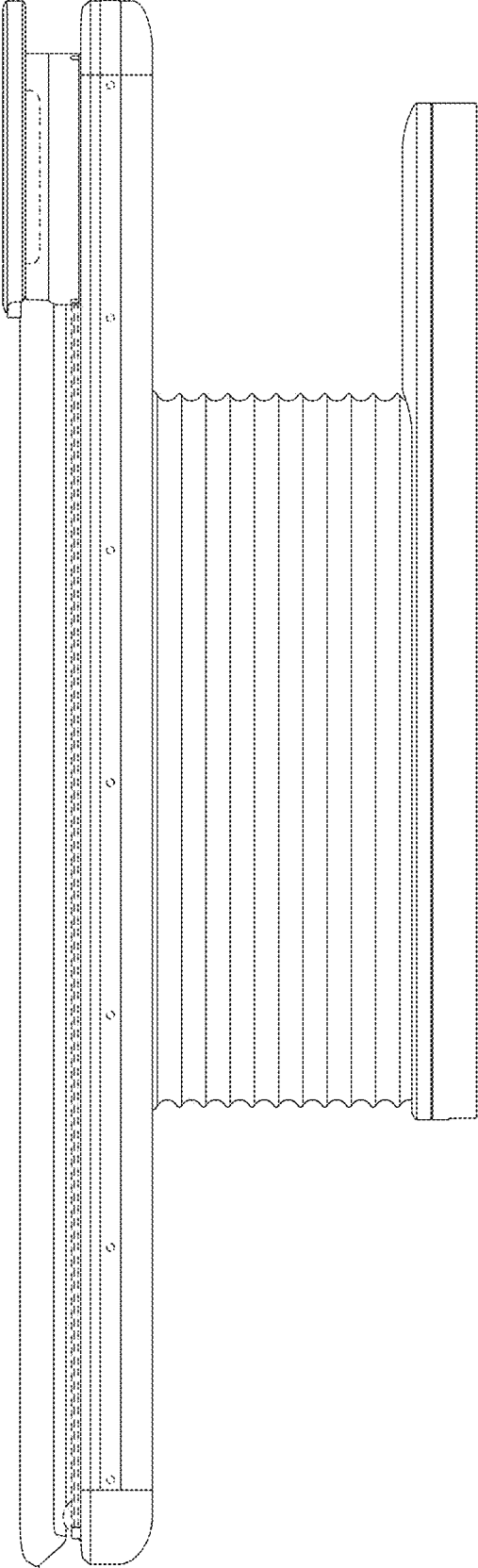

FIG. 53

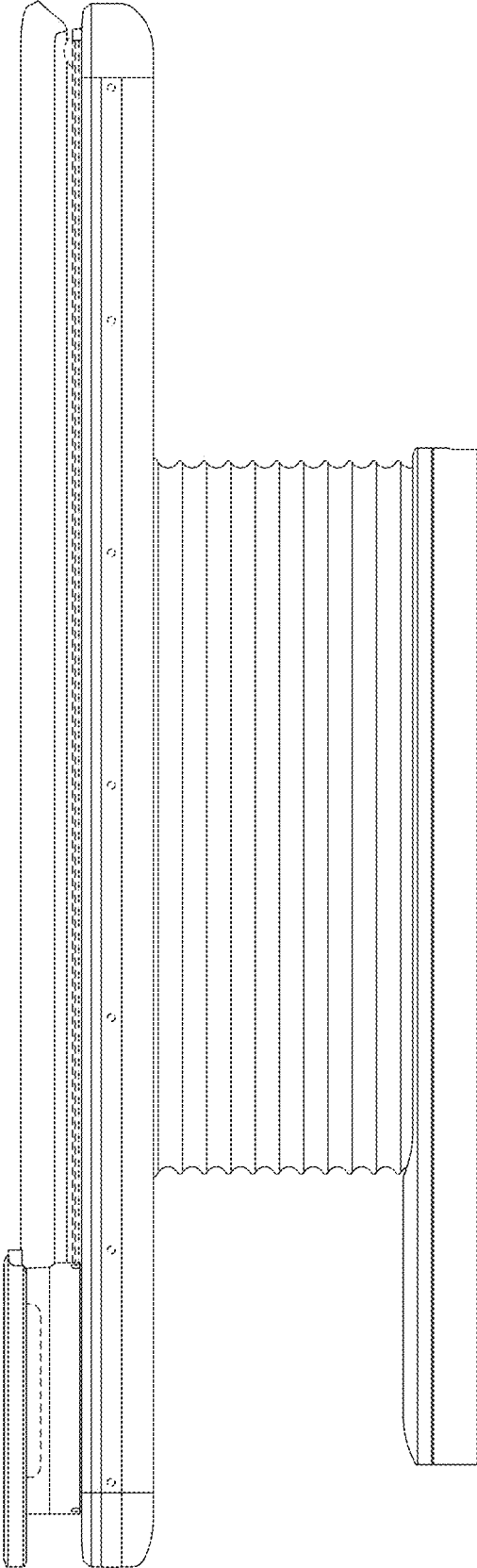

FIG. 54

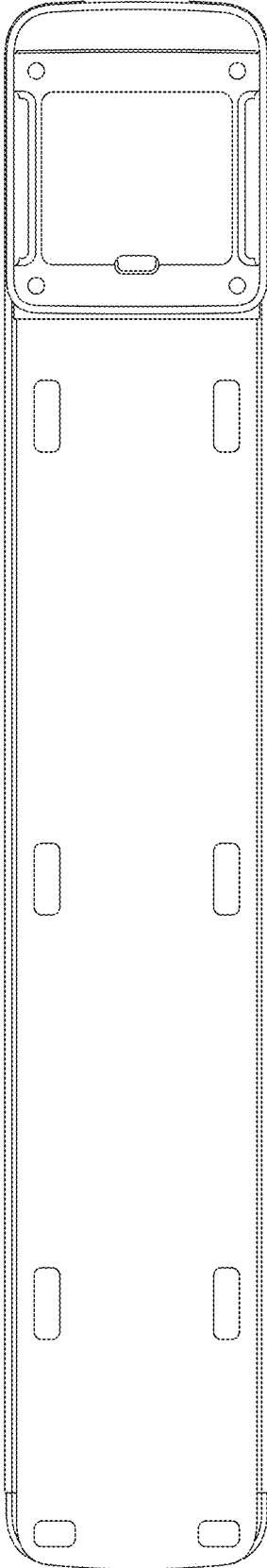

FIG. 55

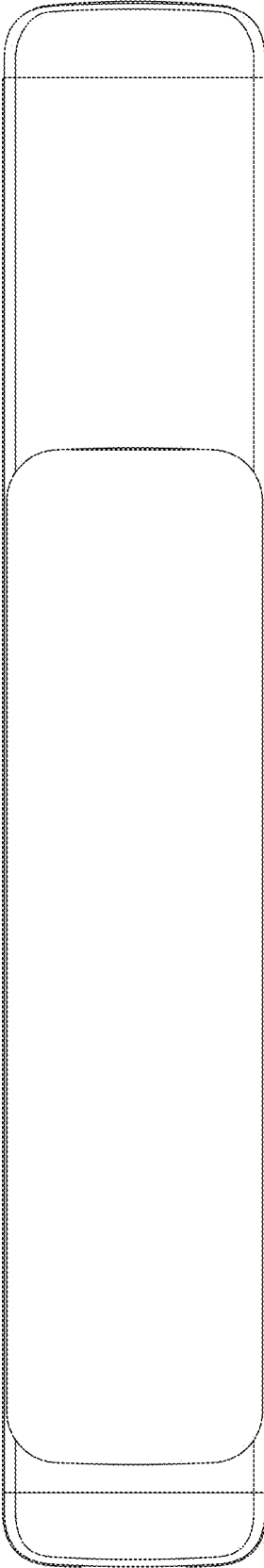

FIG. 56