



(51) International Patent Classification:

G06K 7/10 (2006.01) G02B 21/36 (2006.01)  
G06K 9/46 (2006.01) H04L 9/32 (2006.01)

(21) International Application Number:

PCT/US2018/038087

(22) International Filing Date:

18 June 2018 (18.06.2018)

(25) Filing Language:

English

(26) Publication Language:

English

(30) Priority Data:

62/521,326 16 June 2017 (16.06.2017) US

(71) Applicant: ARIZONA BOARD OF REGENTS ON BEHALF OF ARIZONA STATE UNIVERSITY [US/US];  
1475 North Scottsdale Road, Sky Song - Suite 200, Scottsdale, AZ 85257-3538 (US).

(72) Inventor: KOZICKI, Michael N.; 15027 South 6th Place, Phoenix, Arizona 85048-1802 (US).

(74) Agent: POULIN, Peter et al.; Fish & Richardson, P.C., P.O. Box 1022, Minneapolis, Minnesota 55440-1022 (US).

(81) Designated States (unless otherwise indicated, for every kind of national protection available): AE, AG, AL, AM, AO, AT, AU, AZ, BA, BB, BG, BH, BN, BR, BW, BY, BZ, CA, CH, CL, CN, CO, CR, CU, CZ, DE, DJ, DK, DM, DO, DZ, EC, EE, EG, ES, FI, GB, GD, GE, GH, GM, GT, HN, HR, HU, ID, IL, IN, IR, IS, JO, JP, KE, KG, KH, KN, KP, KR, KW, KZ, LA, LC, LK, LR, LS, LU, LY, MA, MD, ME, MG, MK, MN, MW, MX, MY, MZ, NA, NG, NI, NO, NZ, OM, PA, PE, PG, PH, PL, PT, QA, RO, RS, RU, RW, SA, SC, SD, SE, SG, SK, SL, SM, ST, SV, SY, TH, TJ, TM, TN, TR, TT, TZ, UA, UG, US, UZ, VC, VN, ZA, ZM, ZW.

(84) Designated States (unless otherwise indicated, for every kind of regional protection available): ARIPO (BW, GH,

(54) Title: POLARIZED SCANNING OF DENDRITIC IDENTIFIERS

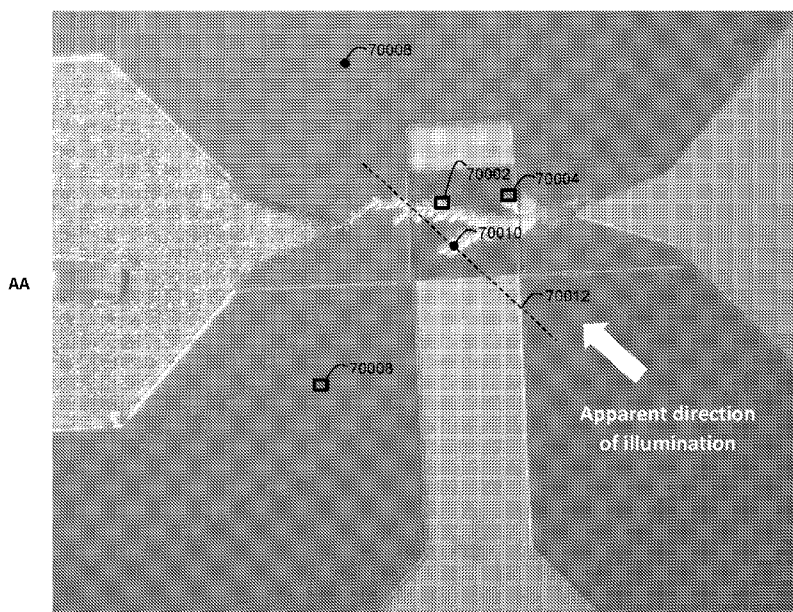

FIG. 70

(57) Abstract: The disclosure features methods and systems that include illuminating a candidate structure with radiation linearly polarized along a first polarization direction and obtaining a first image of the dendritic structure, illuminating the candidate structure with radiation linearly polarized along a second polarization direction and obtaining a second image of the dendritic structure, where an angle between the first and second polarization directions is at least 10, for a set of pixels corresponding to a first region of the candidate structure in the first and second images, determining a first change in average pixel intensity between the first and second images, and authenticating the candidate structure as a dendritic structure based on the first change in average pixel intensity.



GM, KE, LR, LS, MW, MZ, NA, RW, SD, SL, ST, SZ, TZ, UG, ZM, ZW), Eurasian (AM, AZ, BY, KG, KZ, RU, TJ, TM), European (AL, AT, BE, BG, CH, CY, CZ, DE, DK, EE, ES, FI, FR, GB, GR, HR, HU, IE, IS, IT, LT, LU, LV, MC, MK, MT, NL, NO, PL, PT, RO, RS, SE, SI, SK, SM, TR), OAPI (BF, BJ, CF, CG, CI, CM, GA, GN, GQ, GW, KM, ML, MR, NE, SN, TD, TG).

**Published:**

- *with international search report (Art. 21(3))*
- *before the expiration of the time limit for amending the claims and to be republished in the event of receipt of amendments (Rule 48.2(h))*

# POLARIZED SCANNING OF DENDRITIC IDENTIFIERS

## CROSS-REFERENCE TO RELATED APPLICATIONS

This application claims priority to U.S. Provisional Application No. 62/521,326, filed on  
5 June 16, 2017, the entire contents of which are incorporated herein by reference.

## TECHNICAL FIELD

This disclosure relates to dendritic structures, methods for making dendritic structures,  
and applications of dendritic structures, including information coding in dendritic structures.  
10

## BACKGROUND

The present disclosure relates generally to the formation and use of dendritic structures.  
A dendritic structure is a structure that develops with a typical multi-branching, tree-like form.  
Dendritic patterns are very common in nature and are illustrated by diverse phenomena such as  
15 snowflake formation and lightning. Dendritic crystallization forms a natural fractal pattern. A  
fractal is generally defined as a rough or fragmented geometric shape that can be subdivided into  
parts, each of which is (at least stochastically) a reduced-size copy of the whole, a property  
called self-similarity. This self-similarity leads to a fine structure at arbitrarily small scales.  
Because they appear similar (but not identical) at all levels of magnification, fractals are often  
20 considered to be infinitely complex. In practice, however, the finest observable levels of  
structure will be limited by physical and/or chemical constraints.

## SUMMARY

In general, a dendritic metal structure can be formed by the electrodeposition of ions on  
25 or in an ion conductor. There are several viable options for the composition of the ion  
conductor, which can exist as a liquid, solid, or gel. Metals such as silver and copper are  
particularly appropriate as they are highly mobile in a variety of materials and are readily  
reduced and oxidized, which makes the electrochemical aspects of the process relatively  
straightforward. Dendritic structures can be used for a wide variety of applications. For  
30 example, the dendritic structures disclosed herein are used as identification tags for a variety of  
commercial transactions and security applications.

Due to their complex nature, dendritic structures are unique and therefore function as “fingerprints,” enabling unique tagging and later identification of a wide variety of articles. Use of dendritic structures for identification and authentication applications entails robust analysis and recognition of the structures. Accordingly, this disclosure features methods and systems for  
5 acquiring and analyzing images of dendritic structures that rely on the unique properties of the structures to achieve accurate and reproducible analysis results. In particular, polarized light imaging can be used to highlight surface structural attributes of dendritic structures. By qualitatively identifying such attributes, genuine dendritic structures can be distinguished from “copies” or counterfeit structures, for example, based on the interaction of the light with the  
10 structures. Further, images based on illumination with polarized light provide additional quantitative dendritic structure parameters that can be used for authentication and information coding.

In general, in a first aspect, the disclosure features methods that include illuminating a candidate structure with radiation linearly polarized along a first polarization direction and  
15 obtaining a first image of the dendritic structure, illuminating the candidate structure with radiation linearly polarized along a second polarization direction and obtaining a second image of the dendritic structure, where an angle between the first and second polarization directions is at least  $10^\circ$ , for a set of pixels corresponding to a first region of the candidate structure in the first and second images, determining a first change in average pixel intensity between the first and  
20 second images, and authenticating the candidate structure as a dendritic structure based on the first change in average pixel intensity.

Embodiments of the methods can include any one or more of the following features.

The methods can include, for a set of pixels corresponding to a second region of the candidate structure in the first and second images, determining a second change in average pixel  
25 intensity between the first and second images, and authenticating the candidate structure as a dendritic structure based on both the first and second changes in average pixel intensity.

Determining the first change in average pixel intensity can include calculating a normalized average pixel intensity for the set of pixels in the first image, calculating a normalized average pixel intensity for the set of pixels in the second image, and determining the  
30 first change in average pixel intensity based on normalized average pixel intensities for the set of pixels in the first and second images.

Determining the first change in average pixel intensity can include calculating a difference image from the first and second images. The methods can include identifying the first region based on pixel intensity values in the difference image.

5 The methods can include determining an apparent illumination direction associated with the first image, determining an apparent illumination direction associated with the second image, and authenticating the candidate structure as a dendritic structure if an angle between the apparent illumination directions is at least  $3^\circ$ . The methods can include determining the apparent illumination directions in a plane of the candidate structure.

10 Each of the first and second images can correspond to radiation reflected from the candidate structure in response to illumination of the candidate structure with the linearly polarized radiation.

The methods can include, after authenticating the candidate structure as a dendritic structure, determining a set of reference locations and a set of reference reflected radiation intensities associated with the set of reference locations for the dendritic structure, where the sets  
15 of reference locations and reflected radiation intensities correspond to the first polarization direction, and determining an identifier associated with the dendritic structure based on the sets of reference locations and reflected radiation intensities. The identifier can include a data structure based on the sets of reference locations and reflected radiation intensities. The identifier can include a sequence of reflected radiation intensities.

20 Embodiments of the methods can include any of the other features disclosed herein, including combinations of features disclosed in different embodiments, unless expressly stated otherwise.

In another aspect, the disclosure features systems that include a radiation source, a radiation detector, and an electronic processor connected to the radiation source and the radiation  
25 detector, and configured so that during operation, the electronic processor performs any one or more of the methods or method steps disclosed herein. Embodiments of the systems can also include any of the other components disclosed herein, including combinations of components disclosed in different embodiments, unless expressly stated otherwise.

In a further aspect, the disclosure features methods that include illuminating a dendritic  
30 identifier with radiation linearly polarized along a first polarization direction, where the illuminating radiation passes through a light diffusing coating and reflects from a dendritic

structure within the dendritic identifier, directing radiation reflected from the dendritic structure to pass through a polarizing element to generate measurement radiation linearly polarized along a second polarization direction, detecting the measurement radiation to obtain an image of the dendritic structure, and extracting information from the dendritic identifier based on one or more structural features of the dendritic structure determined from the image, where a minimum angle  
5 between the first and second polarization directions is at least 80°.

Embodiments of the methods can include any one or more of the following features.

The first and second polarization directions can be orthogonal. The methods can include directing the radiation reflected from the dendritic structure to pass through the light diffusing  
10 coating before passing through the polarizing element.

The one or more structural features of the dendritic structure can include one or more branch points of the dendritic structure and/or one or more lengths of segments of the dendritic structure and/or one or more angles between segments of the dendritic structure and/or one or more distances of locations on the dendritic structure from a reference point and/or one or more  
15 angles of rotation of locations on the dendritic structure relative to a reference line.

Extracting information from the dendritic identifier can include determining a base  $n$  digit associated with the dendritic identifier, wherein  $n$  is greater than or equal to 2. Determining the base  $n$  digit can include comparing a value of a first one of the one or more structural features to at least one range of values associated with the first feature, and comparing a value of a second  
20 one of the one or more structural features to at least one range of values associated with the second feature, where the first and second features are each selected from the group consisting of an angle between segments of the dendritic structure, a length of a segment of the dendritic structure, a distance of a location on the dendritic structure from a reference point, and an angle of rotation of a location on the dendritic structure relative to a reference line.

The one or more structural features can include a set of coordinates associated with a spatial distribution of the dendritic structure on a coordinate system. The methods can include identifying the set of coordinates by determining portions of the coordinate system into which the dendritic structure extends.

Embodiments of the methods can also include any of the other features disclosed herein,  
30 including combinations of features disclosed in different embodiments, unless expressly stated otherwise.

In another aspect, the disclosure features systems that include a radiation source, a first polarizing element positioned to receive radiation generated by the radiation source and to generate linearly polarized illumination radiation, a second polarizing element positioned to receive reflected radiation and to generate linearly polarized output radiation, a radiation  
5 detector, and an electronic processor connected to the radiation source and the radiation detector, and configured so that during operation, the electronic processor performs any of the methods or method steps disclosed herein. Embodiments of the systems can also include any of the other components disclosed herein, including combinations of components disclosed in different embodiments, unless expressly stated otherwise.

10 Certain features, aspects, and steps are disclosed herein in connection with particular embodiments. In general, however, those features, aspects, and steps are not particular to those embodiments, and can be combined with other embodiments and other features, aspects, and steps as desired. Accordingly, while particular embodiments have been described herein for purposes of illustration, it should be appreciated that other combinations of the features, aspects,  
15 and steps disclosed herein are also within the scope of the disclosure, and that particular embodiments described herein can also include features, aspects, and steps disclosed in connection with other embodiments.

Unless otherwise defined, all technical and scientific terms used herein have the same meaning as commonly understood by one of ordinary skill in the art to which this disclosure  
20 belongs. Although methods and materials similar or equivalent to those described herein can be used in the practice or testing of the subject matter herein, suitable methods and materials are described below. All publications, patent applications, patents, and other references mentioned herein are incorporated by reference in their entirety. In case of conflict, the present  
25 specification, including definitions, will control. In addition, the materials, methods, and examples are illustrative only and not intended to be limiting.

The details of one or more embodiments are set forth in the accompanying drawings and the description below. Other features and advantages will be apparent from the description, drawings, and claims.

## 30 DESCRIPTION OF DRAWINGS

FIG. 1 is a schematic diagram of a dendritic structure formed on a substrate.

FIG. 2 is a photomicrograph of a silver dendritic structure formed on a nickel cathode.

FIG. 3 is a plot showing a profilometry measurement of a dendritic structure.

FIG. 4 is a scanning electron micrograph of the edge of a silver dendritic structure on a silver-doped chalcogenide glass.

5 FIG. 5 is a schematic diagram showing one embodiment of a method for fabricating dendritic structures using a liquid or gel electrolyte.

FIG. 6 is a schematic diagram showing another embodiment of a method for fabricating dendritic structures in which the anode is suspended above the surface of the substrate.

FIG. 7 is an image of dendritic metal structures grown between parallel electrodes.

10 FIG. 8 is a schematic diagram of an embodiment of an electrical reading apparatus for dendritic structures.

FIG. 9 is a schematic cross-sectional view of an electrical device that includes a dendritic metal structure.

15 FIG. 10A is an image showing an anode and cathode disposed on the surface of a solar cell.

FIG. 10B is an image showing dendritic structures fabricated on the surface of the solar cell of FIG. 10A.

FIGS. 11A and 11B are schematic diagrams of a cathode probe array that is used to fabricate dendritic structures.

20 FIG. 12 is a schematic diagram of showing penetration of a cathode probe array through a substrate material.

FIG. 13 is a schematic diagram of a cathode probe array that is used to fabricate a linear array of dendritic structures.

25 FIG. 14 is a schematic diagram of a cathode probe array that is used to fabricate dendritic structures on a continuous substrate.

FIG. 15 is a schematic diagram showing an expanded view of the cathode probe array of FIG. 14.

FIG. 16A is a schematic diagram showing a patterned anode that is used to fabricate dendritic structures.

30 FIG. 16B is a schematic diagram showing a plurality of anode tubes that are used to fabricate dendritic structures.

FIG. 16C is a schematic diagram of a plate anode that is used to fabricate dendritic structures.

FIG. 16D is a schematic diagram of an anode that includes a plurality of fluid delivery channels.

5 FIG. 17 is a schematic diagram showing a station for post-processing fabricated dendritic structures.

FIG. 18 is an image of a dendritic structure.

FIG. 19 is a schematic diagram of a dendritic tag with a protective layer.

FIG. 20 is a schematic diagram of a dendritic tag with a non-conformal protective layer.

10 FIGS. 21A-21C are micrographs of dendritic structures grown on a substrate with an overlying liquid electrolyte.

FIGS. 22A-22B are micrographs of dendritic structures grown on a solid electrolyte material.

15 FIG. 23 is a schematic diagram of a dendritic tag bonded to an article using a layer of adhesive.

FIG. 24 is a schematic diagram of a dendritic tag bonded to an article and having a substrate surface patterned with a series of grooves.

FIG. 25 is a schematic diagram of a dendritic tag that includes a plurality of cuts.

FIG. 26 is a schematic diagram of a dendritic tag bonded to a recess formed in an article.

20 FIG. 27 is a schematic diagram of a dendritic tag that includes encapsulated reactive materials.

FIG. 28 is a flow chart that shows a series of steps for identifying and authenticating goods using dendritic tags.

25 FIG. 29 is a schematic diagram of a scanning device for scanning a tagged article and determining tag information.

FIG. 30 is a schematic diagram of a detachable imaging module connected to a mobile telephone.

FIG. 31A is a schematic diagram of a dendritic tag applied to an article and featuring an integrally formed lens.

30 FIG. 31B is a schematic diagram of a dendritic tag applied to an article and featuring a lens applied to the tag.

FIGS. 32A-32C are schematic diagrams of radial, parallel, and multiple dendritic structures, respectively.

FIGS. 33A-33B are scanning electron micrographs of dendritic structures with tree-like and terrain-like fractal structure in the perpendicular direction, respectively.

5 FIGS. 34A-34B are electron micrographs of dendritic structures grown on different solid electrolytes.

FIG. 35 is a flow chart showing a series of steps for identifying an article tagged with a dendritic tag.

10 FIG. 36 is an image of a United States quarter illuminated with ambient fluorescent light and the flash unit of a mobile telephone.

FIG. 37A is a contrast-adjusted image of a dendritic structure.

FIG. 37B is an image of the dendritic structure of FIG. 37A, with identified features of the dendritic structure overlaid on the image.

15 FIG. 37C is a schematic diagram showing features identified for the dendritic structure of FIG. 37A.

FIG. 38A an image of a dendritic structure that is used to train an algorithm for dendritic structure feature recognition.

FIG. 38B is an image of a dendritic structure, with features of the structure identified by a trained algorithm overlaid on the image.

20 FIG. 39 is a schematic diagram of a cathode with a plurality of conducting tracks that are connected to a subset of the cathode's probes.

FIG. 40 is a schematic diagram of a substrate that includes a plurality of raised structures and dendritic structures grown on the raised structures.

FIG. 41 is a schematic diagram of a dendritic tag applied to a product label.

25 FIG. 42 is a schematic diagram of a dendritic tag applied to a container of a pharmaceutical product.

FIG. 43 is a schematic diagram of a dendritic tag applied to a container seal.

FIG. 44A is an image of a dendritic structure formed of silver that was grown on a paper substrate.

30 FIG. 44B is an image of the dendritic structure of FIG. 44A under perpendicular illumination in an optical microscope.

FIG. 44C is an image corresponding to an enlarged portion of the image in FIG. 44B.

FIGS. 45A-45D are images showing reflected light from the dendritic structure of FIG. 44B, illuminated from different directions.

FIGS. 46A-46D are contrast-adjusted images that correspond to the images of FIGS. 45A-45D, respectively.

FIG. 47A is an image of reflected light from a dendritic structure illuminated from a direction corresponding to the top of the image.

FIG. 47B corresponds to the image of FIG. 47A adjusted for contrast and brightness to reduce scattered light contributions to the image.

FIG. 47C is an image of reflected light from the dendritic structure of FIG. 47A, illuminated from a direction corresponding to the left side of the image.

FIG. 47D corresponds to the image of FIG. 47C adjusted for contrast and brightness to reduce scattered light contributions to the image.

FIGS. 48A-48C are schematic diagrams of a line, a square, and a cube, respectively.

FIGS. 49A-49C are schematic diagrams showing first, second, and higher generational curves formed by replication of the Koch curve.

FIG. 50 is a schematic diagram showing the first, second, and third generations of the Vicsek fractal.

FIG. 51 is a schematic diagram showing two fractal elements that encode binary values.

FIGS. 52A and 52B are plots of information units and capacity, respectively, against magnification for the Koch fractal.

FIGS. 52C and 52D are plots of information units and capacity, respectively, against magnification for the Vicsek fractal.

FIGS. 52E and 52F are plots of information units and capacity, respectively, against magnification for a dendritic structure with fractal dimension 1.7.

FIGS. 53A and 53B are plots showing capacity against magnification for a fractal pattern of fractal dimension 1.7.

FIGS. 54A-54D are schematic diagrams of a dendritic pattern.

FIG. 55 is a schematic diagram of a dendritic pattern analyzed using a box counting technique.

FIGS. 56A and 56B are plots of capacity against magnification for a fractal pattern analyzed according to a quaternary coding scheme.

FIG. 57A is a schematic diagram of a dendritic structure.

5 FIG. 57B is a schematic diagram of a portion of the dendritic structure of FIG. 57A shown in a magnified view.

FIG. 58 is a plot of information capacity against number of parameters for a dendritic structure

FIG. 59 is a schematic diagram of a dendritic structure analyzed using a Cartesian coding technique.

10 FIG. 60 is a plot of a ratio of pattern to grid locations against the number of grid locations for a grid coding technique.

FIG. 61 is a schematic diagram showing a branching structure.

FIG. 62 is a schematic diagram showing a decision tree.

15 FIG. 63 is a schematic diagram showing a dendritic structure analyzed using a polar coding technique.

FIG. 64 is a schematic diagram showing a dendritic structure analyzed using a different polar coding technique.

FIGS. 65A-65C are schematic diagrams showing dendritic structures with varying levels of damage.

20 FIGS. 66A-66D are schematic diagrams showing dendritic structures with fiducial markings.

FIG. 67 is an image showing a copper dendritic structure grown underneath the surface of a material.

FIG. 68 is an image of a dendritic structure illuminated with unpolarized radiation.

25 FIG. 69 is an image of the dendritic structure of FIG. 68 illuminated with linearly polarized radiation.

FIG. 70 is another image of a dendritic structure illuminated with linearly polarized radiation.

30 FIG. 71 is a schematic diagram of an example system for authenticating candidate structures.

FIG. 72 is an image of a credit card that includes a dendritic identifier.

FIG. 73 is a schematic diagram of another example system for authenticating candidate structures.

FIG. 74A shows an image of a dendritic identifier with a hidden dendritic structure, imaged using unpolarized illumination radiation.

5 FIG. 74B shows an image of the dendritic identifier of FIG. 74A, imaged using polarized illumination radiation and polarization filtering of light from the identifier.

FIGS. 75A and 75B are images of a dendritic structure that correspond to orthogonal polarization angles.

Like reference symbols in the various drawings indicate like elements.

10

### DETAILED DESCRIPTION

Dendritic structures appear in a wide variety of natural forms, including, for example, lightning, dielectric breakdown, the flow of rivers, mechanical fractures, and blood vessels.

Typically, the particular forms of these dendritic structures are a product of the physical processes that give rise to them and a component of randomness inherent to flow processes. This disclosure introduces dendritic structures by describing certain features thereof and methods for making such structures, including methods for fabricating dendritic structures that are suitable for large-scale manufacturing. Subsequent sections of this disclosure discuss a variety of applications for dendritic structures, including the use of dendritic structures in commercial transactions.

20

#### Fabrication of Dendritic Structures

One example of a dendritic structure is shown in schematic top view in FIG. 1. Dendritic structure 134 is disposed on a substrate 170. Although dendritic structures in nature form by a wide range of physical and chemical processes, metallic dendritic structures have a number of properties that are advantageous for various applications. For example, metallic dendritic structures can be simply formed and “read” electrically and/or optically and/or using other non-destructive measurement methods (for example, using X-ray fluorescence (XRF) methods). Accordingly, dendritic metal structures are useful in many of the applications disclosed herein.

30 Due to their multi-branched, stochastically grown structure (as will be described further herein), dendritic metal structures can provide an effectively unique, randomly generated

identifier. Moreover, dendritic metal structures can also be made to have “nanoscale” features in their individual conducting elements, which allows them to contain or represent a great deal of information in a relatively small area. Moreover, as will be described in more detail below, because dendritic metal structures can be formed using deposition from a solid electrolyte, the fabrication of such devices can be relatively simple and therefore of low cost. Dendritic metal structures suitable for use in the methods described herein are described generally in U.S. Patent No. 8,345,910, U.S. Patent Application Publication No. US 2011/0254117, and International Patent Application Publications Nos. WO 2012/065076 and WO 2012/065083, the entire contents of each of which are incorporated by reference herein.

A photomicrograph of an example of a dendritic metal structure is shown in FIG. 2, in which dendritic silver structures are grown from a nickel cathode. FIG. 3 is a profilometry measurement of another example of a dendritic metal structure. In general, a dendritic metal structure has a multi-branched structure formed of segments of reduced metallic material. In certain embodiments, dendritic metal structures have an average individual segment width (i.e., in the plane of the dendritic metal structure) of no more than about 300  $\mu\text{m}$  (e.g., no more than about 100  $\mu\text{m}$ , no more than about 10  $\mu\text{m}$ , no more than about 1  $\mu\text{m}$ , or even no more than about 200 nm). In certain embodiments, dendritic metal structures have an average individual segment width of at least about 20 nm.

In some embodiments, dendritic metal structures have an average thickness (i.e., normal to the plane of the dendritic metal structures) of no more than about 100  $\mu\text{m}$  (e.g., no more than about 10  $\mu\text{m}$ , no more than about 5  $\mu\text{m}$ , no more than about 500 nm, no more than about 200 nm, or even no more than about 50 nm). In certain such embodiments, dendritic metal structures have an average thickness of at least about 10 nm.

The areas of dendritic metal structures can range from several  $\text{mm}^2$  to micro- or even nano-scale dimensions, depending on the method of fabrication and the application for which the structures are used. Dendritic metal structures can include one or a plurality of separately-nucleated branched structures, as described in more detail below.

Dendritic metal structures can be formed from a variety of metallic materials. Metals such as silver and copper can be particularly useful as they are highly mobile in a variety of materials and are readily reduced and oxidized so the electrochemical aspects of the fabrication process are relatively straightforward. Silver is especially appropriate for dendritic structure

growth applications due to its nobility and ease of both reduction and oxidation. Accordingly, in certain embodiments, dendritic metal structures are formed from silver. Dendritic metal structures can also be formed, for example, from copper, from zinc, and/or from iron. Dendritic metal structures can also be formed from multiple metals to make duplication of such structures more difficult.

Dendritic metal structures can be formed by electrodeposition in an ion conductor (i.e., an electrolyte) by generating an ion current in the ion conductor and using the flow of ions to build up the dendritic structure in or on the ion conductor via electrochemical processes. The ion conductor can be liquid, gel, or solid, or a combination thereof.

A sustained ion current will only flow through the ion conductor if there is a source of ions at one point and a sink of ions at another. The process of electrodeposition, in which metal cations in the electrolyte are reduced by electrons from a negative electrode (e.g., a cathode), is essentially an ion sink as ions are removed from the electrolyte to become atoms. However, in the absence of an ion source, the reduction of the ions at the cathode occurs at the expense of the electrolyte. The concentration of ions in the solid electrolyte therefore decreases during electrodeposition until the electrode potential equals the applied potential and reduction will cease.

It is therefore desirable in certain embodiments to have an oxidizable positive electrode (e.g., anode) – one which can supply ions into the electrolyte to maintain ion concentration and overall charge neutrality. In the case of a silver (or copper) ion-containing electrolyte, the oxidizable anode can be implemented merely as a solid silver (or copper) member, or a member formed from a compound or alloy containing free metal.

The anode will oxidize when a bias is applied if the oxidation potential of the metal is greater than that of the solid solution. Under steady state conditions, as current flows in the solution, the metal ions will be reduced at the cathode. For the case of silver, the electrode reactions are:



with the bias being supplied by an external power source.

The deposition of Ag metal at the cathode and partial dissolution of the Ag at the anode indicates that fabrication of the dendritic structure is analogous to the reduction-oxidation electrolysis of metal from an aqueous solution, except that when a solid electrolyte is used in fabrication (e.g., rather than a solution of ions), the anions are fixed in position. Accordingly, when a bias is applied across the electrodes, silver ions migrate toward the cathode under the driving force of the applied field and the concentration gradient. At the boundary layer between the electrolyte and the electrodes, a potential difference exists due to the transfer of charge and change of state associated with the electrode reactions. This potential difference, typically in the order of a few hundred millivolts, leads to polarization in the region close to the phase boundary, known as the double layer. Even though the voltage associated with the polarization is small, structures with a long, thin region of solid electrolyte between the electrodes typically require higher voltages to initiate electrodeposition as most of the applied voltage will be dropped across the high resistance electrolyte. For example, the polarization-resistance of a  $10\ \mu\text{m}^2$  electrode will be around  $10^9\ \Omega$ , but if a 50 nm thick  $100\ \Omega\cdot\text{cm}$  Ag-Ge-Se electrolyte between anode and cathode is  $10\ \mu\text{m}$  wide and  $100\ \mu\text{m}$  long, the series resistance will be twice this value and so at least 0.75 V is typically used to generate a 0.25 V drop at the cathode to cause electrodeposition.

As in any plating operation, the ions nearest the electron-supplying cathode will theoretically be reduced first. However, in real-world fabrication processes in which the nanoscale roughness of the electrodes is significant and the fields are relatively high, statistical non-uniformities in the ion concentration and in the electrode topography can promote localized deposition or nucleation rather than blanket plating. Even if multiple nuclei are formed, the nuclei with the highest field and best ion supply will be favored for subsequent growth, extending out from the cathode as individual elongated metallic features. The deposition interface continually moves toward the anode, increasing the field and thereby speeding the overall growth rate of the electrodeposit. Without wishing to be bound by theory, it is believed that the addition of new atoms to the growing electrodeposit occurs through a diffusion-limited aggregation mechanism.

The electrodeposition of metal on the cathode does not mean that ions entering from the oxidizable anode have to travel the entire length of the structure to replace those that are reduced. For example, in solids, the ions move through the electrolyte by a coordinated motion in which the ion closest to the reduced ion will move to the vacated negative site on the hosting material

and those upstream will do likewise, each filling the vacated site of the one downstream, until the last vacated space closest to the anode is filled by the incoming ion. So, in the initial stages of deposition, the electrodeposit is actually made up of reduced ions from the electrolyte itself but since each ion deposited on the growing electrodeposit corresponds to one that has been removed  
5 from the metal source, the net effect is a shift of mass from the anode toward the cathode. In general, the growth process in these structures is more complex than a simple plating operation as the deposition interface is moving toward the source of the ions. Since the electrodeposit is physically connected to the cathode, it can supply electrons for subsequent ion reduction, so the growing electrodeposit will harvest ions from the electrolyte, plating them onto its surface to  
10 extend itself outwards from the cathode. This has two consequences: the growth interface continually moves out to meet the ions, and the growth closes the gap between the electrodes thereby increasing the field. Both of these help to speed the overall growth rate of the deposit.

Without wishing to be bound by theory, in the most general case, it is believed that the process of deposit formation starts with the nucleation of the new metal atom phase on the  
15 cathode and the deposits develop with a structure that generally follows a Volmer-Weber 3-D island growth mechanism. The addition of new atoms to the growing deposit occurs due to a diffusion-limited aggregation (DLA) mechanism, as described for example in T. A. Witten and L. M. Sander, *Phys. Rev. Lett.* 47: 1400 (1981). In this growth process, an immobile “seed” is fixed on a plane in which particles are randomly moving. Particles that move close enough to  
20 the seed in order to be attracted to it attach and form the aggregate. When the aggregate consists of multiple particles, growth proceeds outwards and with greater speed as the new deposits extend to capture more moving particles. Thus, the branches of the core clusters grow faster than the interior regions. The precise morphology depends on parameter such as the potential difference and the concentration of ions in the electrolyte, as described for example in Y.  
25 Sawada, A. Dougherty, and J. P. Gollub, *Phys. Rev. Lett.* 56: 1260 (1986).

At low ion concentrations and low fields, the deposition process is determined by the (non-directional) diffusion of metal ions in the electrolyte and the resulting pattern is fractal in nature. For high ion concentrations and high fields as are common in the methods described herein, the moving ions have a strong directional component, and dendritic structure formation  
30 occurs. The dendritic structures have a branched morphology, but grow along a preferred axis largely defined by the applied electric field. As an example, FIG. 7 shows dendritic metal

structures grown between parallel electrodes (i.e., an anode at the top of the figure and a cathode at the bottom of the figure).

The complexity of the dendritic form in two dimensions is evident from images such as shown in FIG. 7. The stochastic growth process ensures that the shape of every newly-grown  
5 dendritic structure is truly unique. It should be noted, however, that the growth process is generally three dimensional. When a dendritic structure forms inside a solid electrolyte, there are no restrictions on growth direction and the structure will typically branch out like a tree to fill a volume, but even when electrodeposition occurs on the surface of a solid ion conductor, there is still an “upward” component of growth, i.e., in a direction normal to the surface. This occurs  
10 because, in addition to the lateral growth across the surface, there is electrodeposition at the interface between the ion conductor and the metal dendrite. This basal deposition pushes the earlier-deposited material upwards, resulting in a nanoscale “mountainous” three-dimensional form. This form is shown in FIG. 4, which is a scanning electron micrograph of the edge of a silver dendritic structure on a silver-doped chalcogenide glass. The micro- and nano-scale facets  
15 of such 3-D features are once again formed via stochastic processes and introduce yet another layer of complexity (and randomness) to the overall structure.

In some embodiments, dendritic metal structures are formed by methods that include providing an ion conductor and two or more electrodes in contact with the ion conductor, and applying a bias voltage across the electrodes sufficient to grow the dendritic metal structure in or  
20 on the ion conductor. Methods for growing dendritic metal structures are described generally in U.S. Patent No. 8,345,910, U.S. Patent Application Publication No. US 2011/0254117, and International Patent Application Publications Nos. WO 2012/065076 and WO 2012/065083.

The stochastic nature of the electrodeposition process leads to randomly-branched and randomly-faceted patterns each time a dendritic structure is grown on a new region of an ion  
25 conducting medium. As will be discussed subsequently, as a result of their random and unique nature, these dendritic structures can be used to generate unique identifiers that are useful in a variety of applications, including object identification and tracking, and data encryption. The methods and apparatus used to create these patterns is straightforward and the materials involved can be placed on a variety of substrates, including pliable and/or flexible materials. Examples of  
30 device formats and methods for generating dendritic structures are described subsequently in greater detail.

A wide variety of ion conductors can be used, for example, including solid films (e.g., oxides/chalcogenides), gels, and liquids. For certain applications, it can be desirable to use a solid ion conductor. Solid ion conductors are useful due to their mechanical and chemical stability which allows them to be used in the field with minimal encapsulation. Examples of  
5 solid ion conductors suitable for use in certain embodiments include “superionic” solid electrolytes (fast ion conductors) and/or other materials such as oxides which have suitable ion mobility.

Dendritic metal structures can be formed by deposition from a solid electrolyte. In certain embodiments, the solid electrolyte includes silver or copper ions, as such materials tend  
10 to have high ion mobility and can be less difficult to make than alkali metal solid electrolytes. Silver is also well-suited for electrode growth applications due to its mobility and ease of both reduction and oxidation. In some embodiments, copper-containing solid electrolytes can be used to form dendritic copper structures. For example, crystalline Ag halides, principally AgI, and silver chalcogenides, e.g., Ag<sub>2</sub>S, Ag<sub>2</sub>Se, and Ag<sub>2</sub>Te, and their copper counterparts, can be used as  
15 solid electrolytes.

The layer of solid electrolyte can be, for example, a metal-containing chalcogenide glass (i.e., containing oxygen, sulfur, selenium and/or tellurium, although oxide glasses are often treated separately from the others in the literature). Chalcogenide glasses can be formed with a  
20 wide range of physical characteristics and can be made using a variety of techniques, such as physical vapor deposition, chemical vapor deposition, spin casting and melt quenching. The tellurides exhibit the most metallic character in their bonding and are the “weakest” glasses as they can crystallize very readily (hence their use in so-called phase change technologies such as re-writable CDs and DVDs) and the others exhibit an increasing glass transition temperature going further up Group VI of the periodic table, with oxides having the highest thermal stability.  
25 Stable binary glasses can, for example, include a Group IV or Group V element, such as germanium or arsenic, with a wide range of atomic ratios possible. The bandgaps of the chalcogenide glasses range from about 1-3 eV for telluride, selenide and sulfide glasses, to 5-10 eV for the oxide glasses. The non-oxide glasses are typically more flexible than oxide glasses, but more rigid than organic polymers; other physical properties follow the same trend. Such  
30 structural flexibility can result in the formation of voids through which ions can readily move

from one equilibrium position to another. It can also allow chalcogenides glasses to be used with flexible substrates.

In some embodiments, a solid electrolyte formed of Ag-doped  $\text{Ge}_{30}\text{S}_{70}$  is used for dendritic structure fabrication. In other embodiments, different materials can be used as the solid  
5 electrolyte. For example, silver- or copper-doped oxide glasses such as  $\text{SiO}_2$  or transition metal oxides can be used in harsher operating environments. Such glasses can withstand higher processing temperatures, are more resistant to mechanical abrasion and chemical damage, and can provide higher transmission over the visible wavelength range than the higher chalcogenide glasses, but may provide slower dendritic structure growth due to lower ion mobility.

10 In certain embodiments, the chalcogenide glass is a germanium chalcogenide glass. Germanium chalcogenides have relatively low coulombic energies and relatively low activation energies for ion transport. Germanium chalcogenides are desirably glassy in nature; ion conductivity can often be greater in glassy materials than in the corresponding crystalline materials. Of course, crystalline or semi-crystalline materials can also be used. Germanium  
15 chalcogenides also tend to be relatively soft materials, making them suitable for use in certain methods in which the dendritic metal structure is formed, annealed or otherwise moved to the interface between the solid electrolyte and the electrically active structure, as described in more detail below. Germanium chalcogenides are also relatively flexible, and can be used on flexible devices. Accordingly, in some embodiments, devices that include the fabricated dendritic  
20 structure(s) are flexible. These mechanical properties of the germanium chalcogenides also help avoid cracking during thermal expansion and mechanical stress during use.

In certain embodiments, the solid electrolyte includes a solid solution of  $\text{As}_x\text{S}_{1-x}\text{-Ag}$ ,  $\text{Ge}_x\text{Se}_{1-x}\text{-Ag}$ ,  $\text{Ge}_x\text{S}_{1-x}\text{-Ag}$ ,  $\text{As}_x\text{S}_{1-x}\text{-Cu}$ ,  $\text{Ge}_x\text{Se}_{1-x}\text{-Cu}$ ,  $\text{Ge}_x\text{S}_{1-x}\text{-Cu}$ , where x ranges from about 0.1 to about 0.5, other chalcogenide materials incorporating silver, copper, zinc, iron,  
25 combinations of these materials, Ag- and Cu-doped transition metal oxides, Ag- and Cu-doped silicon or germanium oxides, and the like. Photodissolution techniques can be used to load metal and/or metal ions into the solid electrolyte.

In some embodiments, the solid electrolyte includes a germanium-selenide glass with about 10 to about 50 atomic percent silver diffused in the glass (e.g.,  $\text{Ag}_{33}\text{Ge}_{20}\text{Se}_{47}$ ). Such  
30 materials can be formed using evaporation. Additional solid electrolyte materials and methods

of forming them are discussed in U.S. Patent No. 6,635,914, the entire contents of which are incorporated herein by reference.

As one example of the fabrication of the solid electrolyte, a 50 nm layer of  $\text{Ge}_{0.20-0.40}\text{Se}_{0.80-0.60}$  is first deposited onto the surface of an electrically active structure, and the Ge--Se layer is covered with about 20 nm of silver. The silver is dissolved into the Ge--Se glass by exposing the silver to a light source having a wavelength of about 405 nm and a power density of about  $5 \text{ mW/cm}^2$  for about ten minutes. Any excess silver is then removed using a  $\text{Fe}(\text{NO}_3)_3$  solution. The solid electrolyte material is then patterned and etched using reactive ion etching (RIE) (e.g.,  $\text{CF}_4+\text{O}_2$ ) or wet etching (e.g., using  $\text{NaOH}:\text{IPA}:\text{DI}$ ).

The addition of metallic elements such as silver or copper to a chalcogenide glass transforms it into an electrolyte, as silver and copper atoms can form mobile cations within the chalcogenide glass material. The ions are associated with the non-bridging chalcogen atoms but the bonds formed are relatively long. As with any coulombic attraction, the coulombic energy is proportional to the inverse of the cation-anion distance, so long bonds lead to reduced attractive forces between the charged species. The Ge-chalcogenide glasses are therefore among the electrolytes with the lowest coulombic energies. Thermal vibrations will allow partial dissociation, which results in a two-step process of defect formation followed by ion migration. The activation energy for this process strongly depends on the distance between the hopping cation and the anion located at the next nearest neighbor as well as the height of the intervening barrier. In addition to having low coulombic energies, the Ge-chalcogenides also have relatively low activation energies for ion transport. In this respect, the existence of channels due to the structure of the electrolyte is critical in the ion transport process. As an example of this effect, the  $\text{Ag}^+$  conductivity in glassy  $\text{AgAsS}_2$  is a factor of 100 larger than that in the crystalline counterpart due to the more "open" structure of the non-crystalline material.

The rigidity and bonding character of the oxide electrolytes means that their ion mobility is typically orders of magnitude lower than that of the Ge-chalcogenides but this also results in higher thermal, chemical, and mechanical stability. Increased stability suggests that Ag- or Cu-doped oxide glasses, such as  $\text{SiO}_2$  or many of the transition metal oxides (e.g.,  $\text{WO}_3$ ), may be more suitable for harsher operating environments.

Other electrolyte materials can also be used in the fabrication methods disclosed herein. As suggested above, tellurides (e.g., doped germanium tellurides) can also be used in certain

embodiments. In some embodiments, the solid electrolyte is a metal (e.g., copper) doped transition metal oxide.

The solid electrolyte material can have a thickness, for example, in a range of about 1 nm to about 1  $\mu\text{m}$ . In certain embodiments, the layer of solid electrolyte has a thickness in the range of about 5 nm to about 100 nm. In some embodiments, the solid electrolyte has a thickness less than about 10 nm. For example, the solid electrolyte can have a thickness in the range of about 1 nm to about 10 nm. Where the solid electrolyte has low transmissivity at desired wavelengths, use of thinner solid electrolyte layers can improve overall transmission to the electrically-active layer. Such solid electrolyte layers need not be completely continuous on the micro- or nano-scale, as reduced sheet resistance can be achieved even with discontinuous dendritic structures. Moreover, thinner solid electrolyte layers can be more flexible, allowing for increased process and device flexibility. The solid ion conductor may be deposited on the substrate and retained after growth but may also be removed (i.e., before use) to ensure that the dendritic pattern cannot be altered unintentionally after fabrication.

In certain embodiments, the dendritic metal structure is disposed at the interface between a substrate and the electrolyte. For example, in the embodiment shown in the schematic side cross-sectional view of FIG. 9, electrical device 700 includes a cathode 732 disposed at the interface between the substrate 710 (on second substrate 720) and a solid electrolyte 740. A sacrificial anode 746 is positioned, for example, on top of the solid electrolyte. To prevent deposition on top of the solid electrolyte, a growth retarding layer 750 (e.g., a hard oxide layer chemically bound to or oxidatively grown from the top of the electrolyte layer) can be formed thereon. A dendritic metal structure 734 can be formed at the interface between the solid electrolyte and the electrically active structure by the application of a bias. In certain embodiments, the solid electrolyte is a relatively soft glass (e.g., a germanium chalcogenide glass such as silver-doped germanium arsenide or selenide), which can deform slightly to allow the dendritic metal structure to grow at the interface. In such embodiments, the dendritic metal structure can have good electrical contact with the electrically active structure, as there is substantially no solid electrolyte disposed therebetween.

In some embodiments, a liquid or gel electrolyte is used for dendritic structure fabrication. Liquid or gel electrolytes are easier to remove after growth and so may be more suitable for tags which only contain the dendritic structure but not the ion conductor in the field.

If a liquids or gel electrolyte is to be a permanent (or semi-permanent) part of a fabricated device, the device may include additional layers to contain and protect the electrolyte, as will be discussed in greater detail subsequently.

FIG. 5 is a schematic diagram showing one embodiment of a method for fabricating dendritic structures using a liquid or gel electrolyte. The method is described herein with respect to a liquid electrolyte, but it should be appreciated that similar steps can be performed in conjunction with the use of a gel electrolyte. A substrate 410 having a surface 412 and a cathode 422 disposed thereon is provided. Also provided is an anode 424 formed from a metal; in this embodiment, the anode is also disposed on surface 412 of the substrate 410. A liquid 430 in which the metal of the anode is at least partially soluble (i.e., in some cationic form) is then disposed on the surface of the substrate. As shown in FIG. 5, in this embodiment, the liquid is simply disposed as a relatively thin film on the surface of the substrate, held in place by surface tension. The liquid is in electrical contact with both the anode 424 and the cathode 422. A bias voltage is applied across the cathode and the anode sufficient to grow the dendritic metal structure 440 extending from the cathode.

Anode 424 and cathode 422 are positioned relative to substrate 410 so that the dendritic metal structure can be electrodeposited. As the dendritic metal structure grows from the cathode, it is disposed on the on the surface of the substrate. The anode can be, for example, also disposed on the surface of the substrate. In such embodiments, the anode can help to direct the growth of the dendrite.

In other embodiments, the anode is not disposed on the substrate, but rather is in contact with the liquid. In such embodiments, the anode can, for example, be positioned within 1 cm, or even 5 mm of the surface. For example, FIG. 6 shows an embodiment in which the anode 524 is not disposed on the surface 512 of the substrate 510, but rather is suspended slightly above it. In this example, the liquid 530 is provided in a relatively large volume (i.e., in tank 550, in which the substrate bearing the cathode 522 and the anode are also disposed).

In certain embodiments, the anode can be placed (i.e., not deposited, such as in the form of a separate piece of metal) on the surface, then removed from the surface after deposition. In such embodiments, the anode can help to direct the directionality of growth, as described above, but can easily be removed.

In some embodiments, the anode and/or the cathode are placed on the surface of the substrate, but are not deposited thereon. For example, either the anode or the cathode or both can be placed or held in contact with the surface, so as to provide directionality to the growth of the dendritic metal structure, but can be easily removed once growth is complete.

5 In the process of electrodeposition, metal cations in the liquid are reduced at the cathode. To replace the metal cations in the liquid and allow for continued growth of the dendritic metal structure, the anode can include the same metal as the metal of the dendritic metal structure. As the dendritic metal structure grows by reduction at the cathode, the anode is concomitantly oxidized and dissolved into the liquid, resulting in a net mass transfer from the anode to the  
10 growing dendritic metal structure. For example, the anode can be formed of silver, a silver alloy, copper or a copper alloy. When the metal is provided by the anode, the liquid need not have any metal ions dissolved in it when it is disposed on the surface of the substrate. By physically changing the anode material during growth, or by providing an electrical bias in sequence to anodes of differing composition, it is possible to grow a dendritic structure that includes multiple  
15 metals either as a mixture or as segments in the structure. Fabricating dendritic structures in this manner makes subsequent replication of the structures (i.e., in a separate growth process) very difficult.

In some embodiments, the anode need not dissolve into the liquid, and the dendritic metal structures can be grown only from the metal initially dissolved into the liquid. For example, the  
20 anode can be relatively inert, as described below with respect to the cathode. In such embodiments, a relatively large volume of liquid can be provided in order to supply the desired amount of metal cations.

In certain embodiments, it is possible that the ion conductor is not actually a part of the device structure but is instead incorporated in a “writing” apparatus. In such embodiments, the  
25 dendritic structure can be physically transferred to the substrate or otherwise retained on the substrate after growth at the electrolyte-substrate interface. Similarly, in some embodiments, the electrodes are not part of the device and are instead mounted on the apparatus that applies the voltage to the ion conductor, thereby simplifying the device structure.

A transparent layer can be disposed over the dendritic metal structure to protect the  
30 electrodeposit from damage and help to prevent duplication of the structure by the use of impression/molding techniques. This layer can be engineered to allow the growth of the

dendritic metal structure at the interface between the ion conductor and the protective film or it may be applied after growth. The transparent layer can be, for example, a layer of transparent polymer, or a layer of deposited material such as an oxide or nitride of silicon, titanium or germanium.

5 In general, substrates used to support the dendritic structure can be rigid or flexible, and a wide range of different materials having different mechanical properties can be used as substrates. Typically, appropriate ion conductors and electrode materials are selected based on the type of substrate that is used.

10 While a wide range of substrate materials, from insulators to conductors, may be used, in some embodiments an additional barrier layer may be used to prevent interaction between certain substrates and the ion conductor. Thus, the barrier layer is disposed between the substrate and the dendritic metal structure. Accordingly, the barrier layer can be between the ion conductor and the substrate during the electrodeposition operation.

15 Examples of suitable rigid (or semi-rigid) substrates include glass, hard plastic, metals, and semiconductors. Dendritic structures and devices that include such structures can be formed on integrated circuits (either on the chip itself or outside the package). Examples of flexible substrates include plastic sheets, metal foils, smooth paper, and coated close-weave fabrics.

20 Electrodes allow the voltage to be applied to the ion conductor to induce the flow of ions and activate the redox processes necessary for electrodeposition. The electrode materials may be deposited and patterned using a variety of methods including sputtering/etching, lift-off, shadow masking, screen printing, and standard (roll-to-roll) printing using conductive inks. A wide range of viable electrode patterns is possible, including parallel, concentric, and multi-contact configurations.

25 In some embodiments, an anode and a cathode can be formed in contact with a solid electrolyte so that the dendritic metal structure can be electrodeposited. In the process of electrodeposition, metal cations in the electrolyte are reduced at the cathode. To replace the metal cations in the electrolyte and allow for continued growth of the dendritic metal structure, the anode can include the same metal as the metal of the dendritic metal structure and the solid electrolyte. As the dendritic metal structure grows by reduction at the cathode, the anode is  
30 concomitantly oxidized and dissolved into the solid electrolyte, resulting in a net mass transfer from the anode to the growing dendritic metal structure. For example, the anode can be formed

of silver, a silver alloy, copper or a copper alloy. In other embodiments, the anode need not dissolve into the solid electrolyte, and the dendritic metal structures can be grown only from the metal initially dissolved into the solid electrolyte. For example, the anode can be relatively inert, as described below with respect to the cathode.

5           In certain embodiments, the cathode can be relatively inert and generally does not dissolve during the electrodeposition operation. For example, the cathode can be formed from an inert material such as aluminum, tungsten, nickel, molybdenum, platinum, gold, chromium, palladium, metal silicides, metal nitrides, and doped silicon. Of course, in other embodiments, the cathode need not be formed from an inert material. Indeed, when both electrodes are formed  
10 from the metal of the dendritic metal structures, either electrode can act as the anode from which the dendritic metal structures grow, providing additional process flexibility. Appropriate cathode materials can be selected based on the desired electrodeposition conditions. Various configurations of solid electrolyte and electrodes suitable for use in the methods disclosed herein are discussed, for example, in U.S. Patent No. 6,635,914.

15           Contacts may be electrically coupled to the anode and/or cathode to facilitate forming electrical contact to the respective electrodes. Contacts can be formed of any conductive material and are preferably formed of a metal such as aluminum, aluminum alloys, tungsten, or copper. Generating the dendritic pattern typically involves the application of a small voltage (e.g., 0.1 to 10 V) to the electrodes in contact with the ion conducting film.

20           In some embodiments, the fractal dimension of the dendritic structure (i.e., its effective density) can be controlled via the magnitude of the applied voltage; however, the specific shape of the structure is typically random. In certain embodiments, multiple electrodes can be used to generate multiple dendritic forms to fabricate more complex shapes and produce large area dendritic structures. Use of a plurality of dendritic structures in various applications can provide  
25 can provide for information redundancy, e.g., in the event that one of the dendritic structures is damaged.

Fabrication of dendritic structures can occur in a variety of contexts and applications. In some embodiments, dendritic structure growth can be performed during manufacture of a tag or device that uses or includes the dendritic structure. In certain embodiments, dendritic structure  
30 growth can be performed by user, e.g., during implementation of an application of dendritic structure. In this scenario, the ion conductor can be retained within the device. Conversely,

when the dendritic structure is grown during device manufacturing, the fabrication process can be performed with a removable ion conductor. Moreover, provided the electrodes and the ion remain in place, additional growth of the dendritic structure can be performed following manufacture (e.g., during implementation of an application) to deliberately alter an existing  
5 dendritic structure.

In some embodiments, when a sufficient bias (e.g., a hundred mV or more) is applied across the anode and the cathode, metallic ions (e.g.,  $\text{Ag}^+$ ) to move from the anode (in this example, made of silver) and/or from metal dissolved in the solid electrolyte toward the cathode. Metallic ions at the cathode are reduced to form the dendritic metal structure, which grows and  
10 extends from the cathode out onto the solid electrolyte. The amount of electrodeposited material is determined by factors such as the applied voltage, the nature of the metal, the ion current magnitude and the time during which the current is allowed to flow. The dendritic metal structure can be deposited within or on the layer of solid electrolyte as an increased concentration of reduced metal compared to the concentration of such material in the bulk solid  
15 electrolyte material. Electrodeposits can have significant growth parallel to as well as normal to the solid electrolyte surface. The applied bias voltage can typically be, for example, in the range of 200 mV to 20 V, but other bias voltages can also be used.

Dendritic structure growth causes a mass transfer of metal from the solid electrolyte to the growing dendritic structure. For example, when the solid electrolyte has a metallic sheen due  
20 to excess metal, the growth process can transfer that metal to the dendritic structure, thereby increasing the apparent transmission of the solid electrolyte. When the solid electrolyte is not replenished with metal (e.g., by a sacrificial electrode), dendritic structure growth can significantly deplete the solid electrolyte of metal. Depletion of metal in the solid electrolyte can also occur when metal dissolves into the solid electrolyte from the anode much more slowly than  
25 it is plated onto the dendritic metal structures. In general, the bias voltage applied between the anode and cathode can be reversed to redissolve metal from the dendritic structures, thereby providing a method to more precisely tune the extent of dendritic structure growth.

In certain embodiments, the metal ions can, for example, be provided by the anode. For example, the anode can be formed from the metal dissolved in the solid electrolyte, and the metal  
30 of the anode dissolves into the solid electrolyte as the dendritic metal structure is grown.

### Reading Dendritic Structures

Dendritic structures fabricated according to the methods disclosed herein can be used for a variety of applications. Many such applications involve “reading” the structures, which refers to a process of identifying features of the structures which uniquely identify the structures. In this manner, particular dendritic structures can be distinguished from other dendritic structures, allowing dendritic structures to be used in a variety of identification, tagging, tracking, and encoding applications. Because electrodeposited dendritic structures are fractal in nature and possess increasing complexity as the scale is decreased, the complexity of specific identifiers (e.g., numbers or codes) generated from dendritic structures depends on the resolution of the reading techniques.

This section of the disclosure will describe a variety of methods for reading dendritic structures. Certain methods will also be described in more detail later in the disclosure, in some cases in the context of specific applications.

In some embodiments, dendritic structures can be read optically. To implement optical reading, the pattern of the dendritic structure is interrogated using light, which can include wavelengths within and/or outside the visible spectrum, to produce a unique signal. For example, camera imaging may be used to obtain a detailed picture of the dendritic pattern. The acquired pattern can then be algorithmically analyzed to produce a unique code or identifier associated with the dendritic structure that acts as a type of “fingerprint”. CCD (charge-coupled device) or CMOS (complementary metal-oxide semiconductor) cameras can be used to capture images that are analyzed to identify the dendritic structure.

Various levels of detail may result from optical imaging, depending on the magnification and numerical aperture of the lenses used. For example, using a lens with a high numerical aperture, the focal plane may be swept along the z-axis (i.e., the axis normal to the main surface over which the dendritic structure extends) to reveal fine topographical details of the dendritic pattern.

The nature of the light used also affects the type of information that is obtained from the reading process. Laser or bright incoherent illumination light typically produces a particular light scattering (diffuse) pattern via reflections from the various facets of the electrodeposit that can be analyzed either by a camera or an array of photodetectors. Infrared and ultraviolet

illumination (down to the x-ray regime) can also be employed along with detector arrays that are sensitive to these wavelengths.

In certain embodiments, reading the dendritic structure is performed using X-ray fluorescence spectroscopy. X-ray fluorescence (XRF) is a non-destructive measurement method that can be used to characterize the composition of materials, based on the emission of characteristic "secondary" (or fluorescent) x-rays from a material that has been excited by bombardment with high-energy x-rays or gamma rays.

In some embodiments, dendritic structures can be read electrically. For example, electrical reading can be used when optical reading is impractical due to the structure being embedded within an object, or when a direct electrical readout is desirable (e.g., when the dendritic structure is used with an integrated circuit).

Capacitance reading can be performed using an two dimensional array of sensors which measure the local changes in electrical capacitance caused by the presence of the branches of the dendritic pattern and convert this to an electrical output (similar technology is also used for fingerprint recognition, using a capacitive "touch" sensor). The sensor array can, for example, be part of a reading device and/or can be permanently incorporated in the pattern generating device, the latter being particularly appropriate if the pattern generator is embedded in a product such as an integrated circuit. A schematic view of one embodiment of a general electrical reading apparatus is shown FIG. 8.

Resistance or impedance can also be detected at points across a surface using the sensor array apparatus shown in FIG. 8. To measure resistance or impedance, an electrical contact is typically formed between the (conducting) dendritic structure and the sensor array to allow a small current to flow and thereby be detected by suitable sense amplifiers.

In some embodiments, frequency modulated radio frequency waves can also be used to read a conductive dendritic pattern. Different branch shapes will respond to different frequencies, producing distinctive peaks and troughs in the transmitted and reflected frequency spectra. Accordingly, the dendritic structure can be used in a radio frequency identification (RFID) scheme, for example, by being coupled to (e.g., directly or indirectly connected to) a suitable radio frequency antennae or other source of radio-frequency waves. Different dendritic structures will provide different resonant frequencies, and thus different reflected frequencies or electromagnetic signals. For example, methods for reading dendritic structures can include

illuminating the dendritic structure with radio waves of different frequencies, and detecting one or more frequencies of the reflected radio waves. Methods for reading dendritic structures can also include, for example, direct coupling of an electromagnetic signal (e.g., at radio frequencies) into the dendritic structure, and measuring an electromagnetic signal from the dendritic structure at one or more radio frequencies to read the dendritic structure.

Other methods for reading dendritic structures can also be used. For example, ultrasonic techniques can be used to read the basic form of the dendritic structure, which may be sufficient for some applications. Moreover, a combination of multiple reading techniques (e.g., orthogonal multi-readout detection and identification) provides enhanced accuracy and additional security against the forgery of the dendritic structure.

The reading methods disclosed herein can be used in the identification and authentication of objects, the encryption of data, and to access encrypted data. For example, in some embodiments, methods for identifying an object that feature a dendritic structure include reading the dendritic structure to provide a signal, generating a unique identifier from the signal, and identifying the object using the unique identifier. The unique identifier can be, for example, a binary number, a text string, a set of analog values, or an image of the dendritic structure. In certain embodiments, the unique identifier can be generated by applying a numerical method (e.g., a mathematical algorithm) to the signal provided by the reading of the dendritic structure, and generating the unique identifier using the numerical method. The numerical method can be any suitable method that converts data from the reading process into a suitable unique identifier. In certain embodiments, the numerical method uses data from two independent reading techniques as described above. The numerical method can be performed by a computer (i.e., it can be a computer-implemented numerical method). Computer-implemented numerical methods can be performed by a suitably-programmed general purpose computer, for example, or by a microprocessor or other circuit specifically adapted to perform the method.

Currently, many objects are marked with an identifier such as a bar code, but these codes are the same for every copy of the object and so there is no way to track individual objects, unless a unique serial number is included on the object and also read. The unique dendritic structures disclosed herein can be fabricated and read using the techniques described herein, allowing the tracking of individual objects. Since there are a vast number of dendritic structures that can be produced using a few square millimeters of surface, it is feasible to inconspicuously

tag every object to be tracked with its own dendritic structure-based identifier. The unique identifier generated from the dendritic structure can be stored in a database that links the information to details of the object's manufacture, specific characteristics, last known location, etc. Tracking objects in this manner is particularly important for high value/high demand items, and tracking also facilitates market analysis, servicing, recalls, etc.

In some embodiments, objects that include dendritic structures can be identified. Methods for performing such identification can include reading the dendritic structure to provide a signal, generating a unique identifier from the signal, and identifying the object using the unique identifier. Anti-counterfeiting measures for high value objects, including banknotes, high-end goods, and critical components, frequently involve the use of complex optical patterns or the addition of hard to copy images such as holograms. The main problem with these approaches is that the patterns are the same for multiple items and so there is an economic justification for the effort to reproduce them in large quantities (e.g., banknote forgery is extremely difficult and expensive but is clearly worthwhile if large numbers of counterfeit bills are involved). A unique and unobtrusive authentication code for each such item would help to prevent mass counterfeiting as not only would every item have to have a different code, making duplication more difficult, but the code could also be maintained in a database that would be used to confirm authenticity and also track the objects. For example, reading can be performed using a commonly available device such as a smartphone, connected via the Internet to a central database and having a custom attachment to allow high numerical aperture optical scanning or electric reading, so that a purchaser, retailer, or police officer could perform on-the-spot authentication.

The use of dendritic structures as unique "fingerprints" is most effective when dendritic structures are difficult to copy. As discussed previously, the dendritic structure fabrication methods disclosed herein not only produce unique, extremely small two-dimensional dendritic structures, but the structures also feature a complex surface with many facets on the electrodeposit. This 3D pattern is very difficult to reproduce accurately at reasonable cost and so the economic impetus for copying single dendritic structures is greatly reduced.

In some embodiments, a dendritic structure that includes multiple elements can be read using the above techniques and also analyzed using a materials analysis technique, such as x-ray

fluorescence, to determine its composition. This “compositional coding” provides an extra layer of security as it makes counterfeiting the dendritic structure very difficult.

Anti-counterfeiting technologies in semiconductors currently involve custom silicon cores that are added to custom/application specific integrated circuits (ASICs) or placed in a system as a stand-alone chip. These cores are complicated, consume additional power, and add significant area/cost to the ASIC or circuit board. The dendritic structures described herein are simple passive devices that can be added to any circuit with little area penalty and operated at extremely low power to produce a unique digital identifier for each chip. In addition, the structures can be generated in-situ either during manufacture (testing/assembly) or by the user in the field and can also be regenerated multiple times in service. The fabrication methods also produce no external cues; embedded dendritic structures cannot be read by analyzing the chip power consumption or electromagnetic emissions. The dendritic structures can be destroyed by applying a burst of electrical energy from, for example, a battery or supercapacitor in the event that the system containing the structure is tampered with. This allows the structure and the information it represents to be kept out of the hands of those who should not have access to it.

Anti-counterfeiting measures for non-electronic objects, including banknotes and high-end goods, typically involve the use of complex optical patterns or the addition of hard to copy images such as holograms. The dendritic structure fabrication methods disclosed herein not only produce unique two-dimensional structures, but each structure also has a complex surface with many reflective facets on the electrodeposit. Fabricating a structure that would accurately reproduce the 3D light scattering pattern from a dendritic structure is very difficult, and therefore the use of dendritic structures as anti-counterfeiting measures has important advantages over conventional measures.

In some embodiments, data can be encrypted using information derived from dendritic structures. A dendritic structure can be read to provide a signal, and a unique identifier is generated from the signal and used as a key in the encryption of the data. Encryption of data for security during transmission or storage typically involves an encryption key which specifies how the message is to be encoded. An authorized party is able to decode the encrypted data using an algorithm that requires a decryption key that eavesdroppers do not have access to. Conventional encryption schemes typically use a key-generation algorithm to randomly produce keys. True random number generation is generally difficult and typically involves complex algorithms. The

simplicity of the fabrication methods disclosed herein and the random resulting dendritic structures – with only voltage and time as inputs to the fabrication process – is a significant advantage over current methods of random number generation. Since the dendritic structure and therefore the numerical key can be generated inside an integrated circuit during or after  
5 manufacture, the use of dendritic structures for data encryption can be simpler and more secure than other key generation methods. In certain embodiments, the key generator can also be used to provide a digital signature for authentication of information.

Certain features and aspects of particular applications of the dendritic structures disclosed herein have been described above. These and other applications will be described in greater  
10 detail in subsequent sections of this disclosure.

The fabrication methods disclosed herein typically yield, in a straightforward manner, a random identifier (e.g., dendritic structure) via the application of a small voltage to a simple fabrication apparatus. Existing technologies typically either involve complex electronics and algorithms to produce unique and/or random numbers or patterns. Both the apparatus and the  
15 method of generating the dendritic structures are simple and can be performed at low cost. The power consumption in programming and reading the fabricated structures is also very modest.

The following describes one example of fabrication of a dendritic metal structure. On a layer of perylene,  $\text{Ge}_{30}\text{Se}_{70}$  base glass (2400 Å thick) and silver layers (800 Å thick) were thermally evaporated and patterned on the diaphragm. The ratio of  $\text{Ge}_{30}\text{Se}_{70}$  to Ag was  
20 approximately 3:1. Immediately after the deposition, photo-dissolution was performed using a 15 min UV exposure to diffuse silver into the  $\text{Ge}_{30}\text{Se}_{70}$  layer to form the solid electrolyte. The anode (silver) and cathode (nickel) were separately evaporated and patterned on the diaphragm. A voltage bias was then applied across the anode and the cathode to grow a dendritic metal structure.

As another fabrication example, a 50 nm layer of  $\text{Ge}_{0.20-0.40}\text{Se}_{0.80-0.60}$  was first deposited onto the surface of a polysilicon material, and the Ge--Se layer was covered with about 20 nm of silver. The silver was dissolved into the Ge--Se glass by exposing the silver to a light source having a wavelength of about 405 nm and a power density of about 5 mW/cm<sup>2</sup> for about ten minutes. Any excess silver was then removed using a  $\text{Fe}(\text{NO}_3)_3$  solution. The solid electrolyte  
30 material was then patterned and etched to provide a desired shape.

A DC bias from 3 to 10 V was applied to electrochemically grow a dendritic silver structure extending out from the tip of the cathode, which is shown in FIG. 2. FIG. 3 shows a SEM micrograph of the electrodeposited dendritic silver structure. A VEECO NT9800 optical profilometer was used to measure the optical profile in FIG. 3, which shows that the dendritic silver structures had a height on the order of 90 nm.

A further fabrication example is shown in FIGS. 10A and 10B. A cathode and a silver anode were deposited on the surface of a solar cell, and a layer of water was disposed thereon, as shown in the image of FIG. 10A. Dendritic structures were fabricated by applying a 20 V bias across the electrodes for 10 minutes. The dendritic structures are shown in the image of FIG. 10B. Dendritic structure growth was also observed on SiO<sub>2</sub> layers, at an applied bias voltage of 5 V for 10 minutes.

#### Volume Fabrication of Dendritic Structures

As discussed above in connection with FIG. 1, the anode(s) used in the fabrication of dendritic structures is/are typically formed from a metal such as copper, silver, or an alloy of copper and/or silver. The cathode(s) is/are typically formed from any one or more of a variety of electrically conductive materials, such as aluminum, tungsten, nickel, molybdenum, platinum, gold, chromium, palladium, metal silicides, metal nitrides, and/or doped silicon. An electrolyte in the form of a liquid can be deposited atop a substrate so that both the cathode and the anode are positioned within the volume of liquid. The liquid can include, for example, water, or another liquid in which metal cations are soluble. More generally, the electrolyte can include a variety of substances, including gels and solid films, in which metal cations are labile.

The cathode and anode are in electrical contact with the liquid by virtue of their positions within the liquid. Accordingly, when an electrical potential difference is applied between the cathode and the anode, a dendritic structure begins to grow in a general direction from the cathode to the anode. The dendritic structure is generally formed from the metal (or one of the metals) that form(s) the anode. During deposition of the dendritic structure, metal cations in the electrolyte are reduced at the cathode, and extend the dendritic structure in the direction of the anode. In some embodiments, metal atoms of the anode are oxidized to form cations during deposition of the dendritic structure. The cations dissolve in the electrolyte (e.g., a liquid) to replace the reduced cations that form the dendritic structure. In certain embodiments, the anode

is not oxidized, and the dendritic structure is formed only from metal cations dissolved in the liquid when the liquid is deposited on the substrate.

The morphology of a particular dendritic structure will generally depend upon a number of factors, including the geometry of the cathode and anode, the metal cations that form the dendritic structure, the potential difference applied between the cathode and anode, the ionic current between the cathode and anode, the nature of the electrolyte acting as the ion transport medium, and the deposition time. In general, dendritic structures can be formed from a variety of metals including, but not limited to, silver, copper, zinc, gold, iron, tin, and mixtures thereof.

The fabrication methods described so far can readily be used to fabricate a variety of dendritic structures. However, use of dendritic structures for large volume commercial applications and transactions requires that the structures be fabricated in large numbers. The methods disclosed to this point are suitable for relatively low-volume fabrication of dendritic structures. In this section, additional methods are disclosed for fabricating larger numbers of dendritic structures.

FIGS. 11A and 11B illustrate schematically a batch fabrication method for forming dendritic structures on a substrate. In FIG. 11A, a cathode 1310 that includes a plurality of cathode probes 1312 arranged in an array structure is positioned in contact with a substrate 1314 immersed in an electrolyte bath 1316. Positioned on the opposite side of substrate 1314 from cathode 1310 is an anode 1318.

With cathode 1310 and anode 1318 positioned as shown in FIG. 11A, an electrical potential difference is applied between the cathode and anode. As a result of the potential difference, metal cations dissolved in electrolyte bath 1315 are reduced at the tips of each of cathode probes 1312 where the tips contact substrate 1314. At the position of each probe tip on substrate 1314, a dendritic structure grows radially outward in the plane of substrate 1314. In this manner, an array of radial dendritic structures is formed on the surface of substrate 1314, where the positions of the dendritic structures match the positions of the tips of cathode probes 1312 in contact with substrate 1314. After a selected time interval has elapsed during which the potential difference is applied between cathode 1310 and anode 1318, the applied potential difference is removed and cathode 1310 is lifted relative to substrate 1314, yielding a substrate with an array of dendritic structures 1320 formed thereon, as shown in FIG. 11B.

In general, cathode 1310 and cathode probes 1312 are formed from a relatively inert, conductive material. In some embodiments, for example, cathode 1310 and/or cathode probes 1312 can be formed from one or more metals. In certain embodiments, cathode 1310 and/or cathode probes 1312 can be formed from one or more semiconductor or ceramic materials.

5 Examples of materials that can be used to form cathode 1310 and/or cathode probes 1312 include, but are not limited to, aluminum, tungsten, nickel, molybdenum, platinum, gold, chromium, palladium, metal silicides, metal nitrides, and/or doped silicon.

Cathode probes 1312 are typically extended structures arrayed in a pattern in cathode 1310. In some embodiments, the shapes of cathode probes 1312 can influence the geometrical properties of dendritic structures 1320 that are deposited from the tips of the probes, due to the manner in which the geometrical shapes of cathode probes 1312 influence the rate of reduction of metal cations at the probe tips. In some embodiments, for example, cathode probes 1312 are needle-like in shape (e.g., the cross-sectional area of probes 1312 is approximately constant along their width). In certain embodiments, cathode probes 1312 are conical in shape, with a cross-sectional area that varies along their length. In general, however, cathode probes 1312 have a relatively large aspect ratio, which is defined herein the ratio of the length of a probe (e.g., measured in a direction parallel to a central axis of the probe) to its maximum cross-sectional area. For example, the average aspect ratio for cathode probes 312 in cathode 310 can be 2:1 or more (e.g., 3:1 or more, 4:1 or more, 5:1 or more, 7:1 or more, 10:1 or more, 15:1 or more).

20 Although cathode probes 1312 are shown as forming a square or rectangular array in cathode 1310, more generally, cathode probes 312 can be positioned in any regular or irregular geometry in cathode 1310. In some embodiments, for example, cathode probes 1312 can be positioned to form a hexagonal array. In certain embodiments, cathode probes 1312 can be positioned to form a circular array and/or a radial array. More complex patterns of cathode probes 1312 (e.g., patterns featuring two or more different arrays, and/or patterns with different spacings between cathode probes 1312 in different rows, columns, or portions of the pattern) can also be used. In general, different patterns can be used according to the particular morphology of the dendritic structures that are deposited. For example, for dendritic structures that exhibit asymmetrical growth patterns, cathode probes 1312 arranged so that spacings between the probes are not uniform in all directions can be used.

Various methods can be used to fabricate an array of cathode probes 1312. In some embodiments, a probe array can be formed by attaching adjustable rigid or spring-loaded probes to a rigid conducting base plate so that all of the probes are electrically connected, forming a common cathode. In certain embodiments, groups of one or more probes can be connected to individual conducting tracks on a base plate. FIG. 39 shows an embodiment of a cathode 1310 that includes a plurality of conducting tracks 1311, each of which is electrically isolated from the other conducting tracks. Conducting probes 1312 are each connected to one of the conducting tracks. Individual electrical potentials can be applied to each of the conducting tracks 1311. For example, different potentials can be applied to some of tracks 1311 to ensure that uniform growth of dendritic structures occurs across cathode 1310.

In the methods disclosed above, a variety of different materials can be used to form substrate 1314. Typically, substrate 1314 is formed of a material that is sufficiently rigid mechanically to support dendritic structures 1320, but is also sufficiently compliant so that it can be processed later to separate individual dendritic structures. In some embodiments, for example, substrate 1314 is formed of one or more plastics, such as polyethylene (e.g., polyethylene terephthalate, PET), polypropylene, polyester, polystyrene, polyamide, polyolefin, acetate, acrylate, vinyl, polyester, Mylar<sup>®</sup>, Teflon<sup>®</sup>, and/or Teslin<sup>®</sup>. In certain embodiments, substrate 1314 is formed of paper-based materials, such as plasticized paper.

Anode 1318 generally includes the material(s) from which dendritic structures 1320 are formed. For example, in some embodiments, dendritic structures 1320 are formed from (or include) silver, and anode 1318 is likewise formed from (or includes) silver. In certain embodiments, dendritic structures 1320 are formed from (or include) copper, and anode 1318 is likewise formed from (or includes) copper. More generally, dendritic structures 1320 can be formed from one or more metals, and anode 1318 can include some or all of the one or more metals, and can also include additional materials, such as additional metals, as well.

Anode 1318 can include a variety of other materials. In some embodiments, for example, anode 1318 can include one or more relatively inert materials to reduce or prevent undesirable side-reactions (e.g., sulfide formation) from occurring at the anode and/or to promote uniform erosion of anode 1318 during oxidation of the active metal in the anode. For example, metals such as palladium can be included in anode 1318.

Anode 1318 can generally have a variety of shapes. Typically, anode 1318 is shaped to ensure that the electric field across substrate 1314 is spatially uniform to ensure uniform growth of dendritic structures on the substrate.

Electrolyte bath 1316 generally includes dissolved ions of the one or more materials from which dendritic structures 1320 are formed. For example, where dendritic structures 1320 are formed from one or more metals, electrolyte bath 1316 includes dissolved cations of the one or more metals. As explained above, when a potential difference is applied between cathode 1310 and anode 1318, cations dissolved in electrolyte bath 1316 are reduced at the tips of cathode probes 1312, resulting in the growth of dendritic structures 1320 on substrate 1314 at positions where the tips of cathode probes 1312 contact substrate 1314. Atoms of anode 1318 are oxidized by the applied potential difference to form cations, which then dissolve in electrolyte bath 1316, replenishing the cations that were reduced.

In addition to cations of the materials that form dendritic structures 1320, electrolyte bath 1316 includes one or more solvents. The solvents can be in liquid form, such as water and/or other polar liquids. In some embodiments, the solvents can be in the form of gels, such as water-based gels and/or other gels. Examples of gels that can be used in electrolyte bath 1316 to solvate cations for forming dendritic structures 1320 include, but are not limited to, silver nitrate or copper sulfate in cellulose, polymethylmethacrylate, polyacrylamide, and/or polyvinylidene fluoride. Solid electrolytes that can be used in thin film form include, but are not limited to, crystalline silver halides (e.g., AgI) and silver chalcogenides (e.g., Ag<sub>2</sub>S, Ag<sub>2</sub>Se, and Ag<sub>2</sub>Te), and their copper counterparts, and As<sub>x</sub>Si<sub>1-x</sub>--Ag, Ge<sub>x</sub>Se<sub>1-x</sub>--Ag, Ge<sub>x</sub>Si<sub>1-x</sub>--Ag, As<sub>x</sub>Si<sub>1-x</sub>--Cu, Ge<sub>x</sub>Se<sub>1-x</sub>--Cu, Ge<sub>x</sub>Si<sub>1-x</sub>--Cu, where x ranges from about 0.1 to about 0.5, other chalcogenide materials incorporating silver, copper, zinc, iron, and combinations of these materials, Ag- and Cu-doped transition metal oxides, and Ag- and Cu-doped silicon or germanium oxides.

As discussed above, an electrical potential is applied between cathode 1310 and anode 1318 to grow dendritic structures on substrate 1314. Voltages that are applied are typically 100 mV or more (e.g., 200 mV or more, 300 mV or more, 500 mV or more, 700 mV or more, 900 mV or more) and/or 100 V or less (e.g., 80 V or less, 60 V or less, 40 V or less, 30 V or less, 20 V or less, 10 V or less). The magnitude of the applied electrical potential is generally selected to control the growth rate and/or growth morphology of the dendritic structures on substrate 1314.

The growth duration typically ranges from 1 s or more (e.g., 2 s or more, 4 s or more, 6 s or more, 8 s or more) to 60 s or less (e.g., 50 s or less, 40 s or less, 30 s or less, 20 s or less).

Dendritic structures 1320 used for the applications that will be discussed subsequently are typically relatively small. For example, dendritic structures 1320 can have a maximum  
5 dimension measured in the plane of substrate 1314 of about 2 mm or less. Accordingly, dendritic structures 1320 are relatively delicate. If the structures deposited adhere to the tips of cathode probes 1312 when the probes are lifted from the surface of substrate 1314, dendritic structures 1320 can be significantly disrupted, and may even be destroyed.

To avoid damaging dendritic structures 1320 in this manner, various methods can be used  
10 to reduce the likelihood that dendritic structures 1320 will adhere to the tips of cathode probes 1312. In some embodiments, for example, the surfaces of cathode probes 1312 can be coated in a material that reduces such adherence. Examples of materials that can be used for this purpose include, but are not limited to, conductive liquids such as various oils, and conducting solids such as graphite.

15 In addition, or as an alternative, in some embodiments, dendritic structures 1320 can be deposited on the side of substrate 1314 opposite to cathode 1310. FIG. 12 shows a schematic diagram illustrating such methods. In FIG. 12, a cathode 1310 that includes a plurality of cathode probes 1312 is positioned so that the tips of cathode probes 1312 pierce substrate 1314, which is positioned in an electrolyte bath 1316 such that the upper surface of substrate 1314 (i.e.,  
20 the surface closest to cathode 1310) does not contact the electrolyte bath. Anode 1318 is also in contact with electrolyte bath 1316.

As shown in FIG. 12, the tips of cathode probes 1312 extend through substrate 1314 to the underside of the substrate (i.e., the side of substrate 1314 closest to anode 1318, and opposite to the side on which cathode 1310 is nominally positioned. When a potential difference is  
25 applied between cathode 1310 and anode 1318, electrodeposition of dendritic structures 1320 occurs at the tips of cathode probes 1312, as described above. However, because the tips of cathode probes 1312 are positioned on the underside surface of substrate 1314 as shown in FIG. 12, dendritic structures 1320 are electrodeposited on the underside surface of the substrate. After deposition is complete (i.e., after the deposition time has elapsed), cathode 1310 is lifted away  
30 from substrate 1314, withdrawing cathode probes 1312 from the substrate. As cathode probes 1312 are lifted, however, dendritic structures 1320 remain positioned on the underside surface of

substrate 1314. Using this technique, damage to the fragile dendritic structures can be significantly mitigated or eliminated.

In FIGS. 11A and 11B, an array of cathode probes 1312 is arranged on cathode 1310 to form a corresponding array of radial dendritic structures 1320 on the surface of substrate 1314.

5 More generally, however, the cathode probes 1312 can be positioned to fabricate large numbers of dendritic structures 1320 with a variety of shapes.

For example, in some embodiments, the cathode can include a plurality of cathode probes arranged to fabricate parallel dendritic structures. FIG. 13 is a schematic diagram illustrating a method for forming dendritic structures that extend in approximately parallel directions with respect to one another. In FIG. 13, a cathode 1410 featuring a one-dimensional array of cathode probes 1412 is positioned within an electrolyte bath 1416 so that the cathode probes are in contact with a substrate 1414. Also positioned within bath 1416 is an anode 1418. When an electrical potential difference is applied between cathode 1410 and anode 1418, dendritic structures 1420 grow approximately along the direction indicated by arrow 1422. In general, in the method shown in FIG. 13, the features of cathode 1410, cathode probes 1412, substrate 1414, electrolyte bath 1416, and anode 1418 are similar to the features disclosed in connection with the corresponding components shown in FIGS. 11A and 11B.

In some embodiments, dendritic structures are fabricated on non-planar substrates using the methods discussed above. FIG. 40 shows an embodiment of a substrate 1314 that includes a plurality of raised structures 1315. Dendritic structures 1320 are grown on the surfaces of raised structures 1315. In some embodiments, a single dendritic structure 1320 is grown on each raised structure 1315. Alternatively, in certain embodiments, multiple dendritic structures 1320 can be grown on each raised structure 1315, so that the height of dendritic structures 1320 above the planar portion of substrate 1314 will, in general, vary.

25 A variety of different patterned substrates 1314 can be used to support dendritic structures 1320. In addition to patterns of raised structures 1315 as shown in FIG. 40, substrates having surfaces that are scored, corrugated, curved, undulating, and include various combinations of non-planar features can function as growth surfaces for dendritic structures. In addition, dendritic structures 1320 can be grown on a variety of substrates with curved surfaces.

30 For example, dendritic structures 1320 can be grown on a cylindrical or spherical surface of a substrate 1314.

Using a non-planar substrate 1314 can provide a number of advantages. For example, when dendritic structures 1320 are grown on a non-planar substrate 1314, the dendritic structures conform – at least to some extent – to the shape of the substrate. As a result, duplicating particular dendritic structures is made more difficult. Further, certain printing methods are not  
5 capable of producing dendritic structures on a non-planar substrate, thus foreclosing these methods from replicating the dendritic structures.

Further, in some embodiments, the non-planar features of substrate 1314 (e.g., raised structures 1315 in FIG. 40) can be used to prevent tampering with the dendritic structures. For example, raised structures 1315 can be filled with a mildly corrosive material (e.g., a mild acid or  
10 base). If tampering with the fabricated dendritic structures 1320 occurs, the corrosive material is liberated from raised structures 1315 and erodes dendritic structures 1320, rendering them unsuitable for authentication or other applications. In this manner, improper transfer of the dendritic structures from one article to another can be prevented. Additional methods for preventing tampering with dendritic structures will be discussed subsequently.

15 In addition, in certain embodiments, raised structures 1315 filled with a mildly corrosive material can be used to fabricate time-limited (e.g., expiring) dendritic structures. In particular, raised structures 1315 can be fabricated from a material that is at least partially porous to, or eroded by, the corrosive material so that over time, the corrosive material penetrates through structures 1315 and erodes dendritic structures 1320. Once eroded, dendritic structures cannot  
20 be used for authentication or other applications. In this manner, time-limited, or expiring, dendritic structures (e.g., where the time limit is determined by the rate at which dendritic structures 1320 are eroded by the corrosive material in raised structures 1315) can be fabricated.

The foregoing methods for large-volume fabrication of dendritic structures may collectively be thought of as batch methods, as they involve forming multiple dendritic structures  
25 on a common substrate during a common growth period. Other methods can also be used for large-volume fabrication of dendritic structures. For example, a variety of continuous, roll-to-roll methods can also be used.

FIG. 14 is a schematic diagram illustrating an example of a method for continuous fabrication of dendritic structures. In FIG. 14, substrate 1514 is provided in spool form, mounted  
30 on substrate feed roller 1522. Also shown in FIG. 14 are cathode 1510, implemented as a roller that rotates in the direction shown by arrow 1530. Cathode 1510 includes a plurality of cathode

probes 1512 that extend radially outward from the cathode. Cathode 1510 is positioned partially immersed in electrolyte bath 1516. Anode 1518 forms a vessel that contacts and contains electrolyte bath 1516.

Substrate 1514 is threaded over guide roller 1532, around cathode roller 1510 and  
5 through electrolyte bath 1516, over guide roller 1534, and onto product roller 1524. To fabricate dendritic structures on substrate 1514, the substrate is translated in the direction shown by arrows 1526 and 1528, e.g., by activating product roller 1524 to draw substrate 1514 from substrate feed roller 1522 over guide roller 1532, around cathode 1510 and through electrolytic bath 1516, over  
10 guide roller 1534, and onto product roller 1524. When each portion of substrate 1514 passes through electrolyte bath 1516, a potential difference is applied between cathode 1510 and anode 1518. Cathode probes 1512 contact the surface of substrate 1514. Dendritic structures grow radially on the surface of substrate 1514 at positions where cathode probes 1512 contact the substrate. In general, the features associated with the cathodes, anodes, substrates, and electrolyte baths described above also apply to the components shown in FIG. 14.

15 In FIG. 14, substrate 1514 is typically fed continuously through electrolyte bath 1516. However, in some embodiments, substrate 1514 can be fed in a step-wise manner through the electrolyte bath, e.g., depending on the ease with which dendritic structures grow on a moving substrate. Typically, portions of substrate 1514 remain immersed in electrolyte bath 1516 for a period of time from a few seconds (e.g., 2 seconds or more, 5 seconds or more, 10 seconds or  
20 more, 20 seconds or more) to a few hundred seconds (e.g., 900 seconds or less, 800 seconds or less, 600 seconds or less, 400 seconds or less, 300 seconds or less, 200 seconds or less, 100 seconds or less).

In some embodiments, substrate 1514 can be co-rolled with one or more additional materials on product roller 1524 to reduce or prevent damage to the dendritic structures.  
25 Materials that are suitable for co-rolling with substrate 1514 include the various materials disclosed herein that are used for encapsulating dendritic structures.

As discussed in connection with FIG. 12, in some embodiments, the dendritic structures can be grown on the underside of substrate 1514 (e.g., the side of substrate 1514 closest to anode 1518) to make it easier to separate the delicate structures from cathode probes 1512. In the  
30 method shown in FIG. 14, the tension maintained in substrate 1514 by product roller 1524 and feed roller 1522 can be used to ensure that cathode probes 1512 penetrate through substrate 1514

and rest on the underside surface of the substrate. Once the dendritic structures are grown on the underside of substrate 1514, cathode probes 1512 are withdrawn from the substrate by the rotational motion of cathode 1510, leaving intact dendritic structures on the substrate.

5 The tension maintained in substrate 1514 by product roller 1524 and feed roller 1522 has the added benefit of ensuring close contact between the upper surface of substrate 1514 and cathode 1510, so that electrolyte bath 1516 does not contact the upper surface of substrate 1514. As a result, dendritic structure growth is confined to the underside surface of substrate 1514.

10 In some embodiments, to grow dendritic structures on the upper surface of substrate 1514 (e.g., the surface closest to cathode 1510), spacers can be used to ensure that cathode probes 1512 contact the upper surface rather than penetrating the substrate through to the lower surface. FIG. 15 shows a schematic diagram of an embodiment of cathode 1510, in which spacers 1536 are positioned on the surface of the cathode so that cathode probes 1512 do not penetrate through substrate 1514, and instead only contact the upper surface of substrate 1514. Alternatively, or in addition, spacers can be positioned directly on cathode probes 1512 to ensure that the probes  
15 contact only the upper surface of substrate 1514. In general, spacers positioned on the surface of cathode 1510 and/or on cathode probes 1512 can be formed from a variety of materials. Examples of suitable materials include, but are not limited to, ceramics, polymers, and inert metals.

20 The methods shown in FIGS. 11A, 11B, and 12-14 involve the growth of dendritic structures in electrolyte baths. However, large-volume fabrication methods for dendritic structures that do not involve electrolyte baths can also be used. In particular, substrates can be pre-coated or pre-immersed in an electrolyte to enable dendritic growth without using an electrolyte bath. FIG. 16A is a schematic diagram of a substrate 1614 that supports the growth of dendritic structures. Substrate 1614 includes a base layer 1640 formed from one or more of  
25 the materials disclosed previously for substrate 1314. Substrate 1614 also includes an electrolyte layer 1638. In some embodiments, electrolyte layer 1638 can include one or more thin, solid films formed on base layer 1640. Suitable materials for forming such a film include, but are not limited to, any of the materials disclosed previously in connection with solid electrolytes. In certain embodiments, electrolyte layer 1638 can include one or more gel layers applied to base  
30 layer 1640. Suitable gel materials include, but are not limited to, any of the materials disclosed previously in connection with gel-based electrolytes. In some embodiments, electrolyte layer

1638 can include a porous sheet (e.g., formed of a material such as paper) that includes (e.g., is infused with) a liquid electrolyte material. Suitable liquid electrolytes include any of the electrolyte solutions disclosed previously.

Substrate 1614 is generally compatible with the fabrication methods discussed  
5 previously. Thus, for example, substrate 1614 can be used to support the growth of dendritic structures via immersion baths, as shown in FIGS. 11A, 11B, and 12, and also via continuous fabrication methods as shown in FIG. 14. Growth of the dendritic structures can occur on either the upper or lower surface of substrate 1614.

In FIG. 16A, substrate 1614 includes an electrolyte layer 1638. In some embodiments,  
10 substrate 1614 can be pre-immersed in an electrolyte solution in addition to, or as an alternative to, the inclusion of electrolyte layer 1638. Immersing the substrate in an electrolyte solution infuses the substrate with metal cations that are subsequently reduced at the cathode to grow dendritic structures. In general, a variety of different electrolyte solutions can be used for immersion of substrate 1614, including any of the solutions corresponding to the electrolyte  
15 baths discussed above. Moreover, a variety of substrate materials are effective at absorbing electrolyte solutions, including, but not limited to, a variety of porous materials such as different paper-based materials.

High quality dendritic structures have been successfully grown on a variety of paper-based materials. Various methods can be used to fabricate dendritic structures on paper. In  
20 some embodiments, for example, a paper substrate (e.g., laboratory filter paper) is soaked in an electrolyte solution. While any of the electrolyte materials disclosed herein can be used to immerse the paper substrate, silver nitrate solutions have been found to yield good results. The concentration of the solution used is typically larger than 0.01 M, e.g., between 0.1 M and 1.0 M. A silver nitrate solution at a concentration of 0.1 M has been found to yield good results.

25 After the paper has been soaked, a cathode is positioned on the paper where the dendritic structure will be grown. Dendritic structures can be fabricated on the paper without applying an anode, since the metal ions that form the dendritic structure are present in the electrolyte solution taken up by the paper substrate. However, in certain embodiments, an anode can be positioned at another location (e.g., different from the cathode location) on the electrolyte-soaked paper.

30 Next, an electrical potential difference is applied between the cathode and the electrolyte in the paper or the anode (if the anode is present). Typically, a potential difference of

approximately 10 V is applied for a few tens of seconds (e.g., between 10 s and 60 s) to grow the dendritic structure at the position of the cathode on the paper substrate. Following growth of the dendritic structure, the cathode (and anode, if present) are removed from the paper substrate, and the paper is dried.

5           Using paper-based substrates provides a number of important advantages. Paper is a low-cost material that is available in large quantities and a variety of different forms (e.g., compositions, textures, strengths). As a result, the nature of the paper selected for the substrate can be chosen based on the intended application; for example, stronger paper substrates can be selected for applications that are anticipated to involve more frequent mechanical handling of the  
10 dendritic structures.

Dendritic structures have also been observed to adhere well to paper-based substrates. Without wishing to be bound by theory, the observed adherence may be due to the relatively rough surface of paper at the microscopic level. As papers with a wide variety of different textures can be used as substrates, adherence of the fabricated dendritic structure to the substrate  
15 can therefore be selected based on the choice of paper used for the substrate.

In addition, paper-based materials are typically porous and as a result, a variety of different electrolyte materials can be introduced into paper-based substrates using techniques such as immersion (e.g., soaking), as described above. Introducing electrolyte materials directly into the substrate significantly simplifies the growth process for the dendritic structures.  
20 Moreover, as described above, in some embodiments dendritic structures can even be grown without using an anode.

The methods disclosed herein for fabricating dendritic structures directly on paper-based substrates enable the use of dendritic structures as security-related elements in a variety of important security-related applications. Many financial, legal, and identification documents are  
25 printed on paper, and are therefore subject to possible duplication and/or forging. More generally, a wide variety of controlled documents (e.g., documents over which security access restrictions are imposed, including secret papers, plans, blueprints, etc.) are printed on paper. Using the methods disclosed herein, dendritic structures can be fabricated directly on such documents using low-cost, rapid processing techniques. Further, using methods that are  
30 described in greater detail subsequently, the dendritic structures can be authenticated, and then used to identify the documents on which they are grown. The strong adherence of the dendritic

structures to paper-based substrates makes removal of the dendritic structures from the documents difficult. Mechanical and/or chemical methods for removal, for example, are likely to lead to destruction of the dendritic structures, preventing identification of the documents on which they are grown. In this manner, dendritic structures can be used to identify and secure a wide variety of documents that would otherwise be subject to counterfeiting efforts. Examples of such documents include, but are not limited to, banknotes, cheques, bearer bonds, stock certificates, wills, contracts, deeds, passports, birth certificates, and licenses of varying types (e.g., driver's licenses).

In addition to paper-based substrates, a variety of porous substrates can be used for the fabrication of dendritic structures using techniques similar to those disclosed above. In fabrication methods involving such substrates, an electrolyte (e.g., a liquid, gel, or paste electrolyte) is applied to the substrate material by immersion, spraying, contact deposition, or a direct mechanical application. A cathode is applied to the substrate surface and electrolyte and, optionally, an anode can also be applied. An electrical potential difference is applied between the cathode and the electrolyte in the porous material (or the anode, if present) to grow the dendritic structure. Using such methods, the fabricated dendritic structures adhere very strongly to the porous substrate. Without wishing to be bound by theory, it is believed that the strong adhesion occurs because the dendritic structures at least partially form in the pores or gaps of the substrate material, which physically "locks" the dendritic structures in place on the substrate surface. The foregoing fabrication methods are therefore particularly well suited to prevention of tampering with the dendritic structures, as the physical adhesion and "locking" of the structures to the porous substrate makes mechanical or chemical removal of the structures from the substrate – without damaging the structures – very difficult.

As described above, when the electrolyte material (e.g., liquid, paste, or gel) has an ionic concentration that is sufficiently large (typically, greater than 0.01 M), and the electrolyte material is "sacrificial" (e.g., it is not retained after growth for subsequent fabrication of additional dendritic structures), the dendritic structures can be grown without an oxidizable anode that includes the same material (e.g., metal atoms) from which the dendritic structures are fabricated. Instead, the material used to form the dendritic structures can be supplied by the electrolyte. Fabricating dendritic structures in this manner can be advantageous, as it permits a

variety of non-reactive (e.g., non-oxidizable) anode materials to be used. Examples of such materials include tungsten, stainless steel, and platinum.

Where the electrolyte material is sacrificial, growth of the dendritic structures can occur without using an anode, as discussed above. Where the electrolyte material is not sacrificial (e.g., when the electrolyte material is used in the fabrication of multiple batches of dendritic structures), replenishment of the metal ions in the electrolyte is typically needed following a growth batch. As discussed herein, replenishment can occur from an oxidizable anode. However, the oxidizable anode does not have to be in contact with the substrate on which the dendritic structures are grown. For example, a non-reactive anode can be used to contact the growth region of the substrate, and an electrical potential difference can be applied between the cathode and the non-reactive anode to initiate growth of the dendritic structures. A sacrificial anode can be positioned away from the growth region but still in contact with the electrolyte material to replenish the ions in the electrolyte. In some embodiments, fabrication of dendritic structures and subsequent processing on the fabricated structures are performed more easily if the sacrificial anode does not contact the growth region of the substrate.

Substrate 1614 in FIG. 16A includes a plurality of anodes 1618 patterned on the substrate. In some embodiments, e.g., where electrolyte layer 1638 includes a solid electrolyte material, anodes 1618 can be deposited as a patterned film on electrolyte layer 1638 using methods such as physical and/or chemical vapor deposition. Anodes 1618 can be formed from any one or more of the materials disclosed previously in connection with anode 1318.

As shown in FIG. 16A, anodes 1618 can be deposited in a patterned film that includes a plurality of openings 1613. Contact between cathode probes 1612 and electrolyte layer 1638 occurs within openings 1613, and growth of the dendritic structures therefore occurs within the openings as well. Although anodes 1618 are patterned on the side of substrate 1614 on which contact with cathode probes 1612 occurs in FIG. 16A, anodes 1618 can also be patterned on the opposite side of substrate 1614.

In some embodiments, anodes 1618 can be provided in the form of a metal plate with openings to allow contact between cathode probes 1612 and the electrolyte material. Referring to FIG. 16A, anodes 1618 can be implemented in the form of a plate (e.g., formed of a metal such as copper, or any of the other anode materials disclosed herein), where openings 1613 with cross-sectional shapes that are circular, elliptical, square, rectangular, or other regular or irregular

shapes allow the cathode probes access to electrolyte layer 1638. FIG. 16C shows a schematic diagram of an anode plate 1618 that includes a plurality of openings 1613. The plate can be placed in contact with electrolyte layer 1638 prior to the growth of the dendritic structures, and removed from layer 1638 when growth of the structures is complete.

5 In certain embodiments, substrate 1614 does not include anodes 1618. Instead, one or more anodes 1618 can be provided separately from substrate 1614 (e.g., as a separate electrode or electrodes that contacts substrate 1614 only during growth of dendritic structures). FIG. 16B shows an embodiment in which a substrate 1614 includes a base layer 1640 and an electrolyte layer 1638 as discussed above. In FIG. 16B, a plurality of cathode probes 1612 contact  
10 electrolyte layer 1638. Further, a plurality of anodes 1618, each of which is concentrically positioned relative to a corresponding cathode probe 1612, also contact electrolyte layer 1638. When an electrical potential is applied between cathode probes 1612 and their corresponding anodes, dendritic structures grow at positions where cathode probes 1612 contact electrolyte layer.

15 Anodes 1618 can generally be implemented in a variety of different geometries. In FIG. 16B, anodes 1618 are shown as a plurality of hollow tubes or rings that are coaxial with cathode probes 1612. Other geometries are also possible including, for example, flat rings, hollow prisms, and pluralities of needle-like probes that are arranged in circular or other regular geometries.

20 Coaxial ring or tube anodes, as shown in FIG. 16B, are particularly useful for simultaneously fabricating multiple radial dendritic structures. The symmetry of such anodes typically yields radial dendritic structures with a high degree of radial symmetry. Moreover, ring and/or tube anodes shield each dendritic growth point (e.g., the point where cathode probe 1612 contacts electrolyte layer 1638) from the other growth points, yielding highly uniform dendritic  
25 structure formation across the substrate.

When dendritic structures are grown on a substrate material that has been infused with the electrolyte material (e.g., a porous substrate to which electrolyte material has been applied or introduced), the one or more anodes 1618 can be on the same side of the substrate as, or opposite side from, cathode probes 1612. Where anodes 1618 are positioned on the opposite side of the  
30 substrate from cathode probes 1612, either the cathode probes 1612 or anodes 1618 can penetrate

into the substrate (e.g., into electrolyte layer 1638) to enhance the growth of the dendritic structures.

In some embodiments, electrolyte materials can be delivered by anodes 1618, cathode probes 1612, or both the anodes and cathode probes, to the substrate during fabrication of the dendritic structures. For example, FIG. 16D shows a cross-sectional view of an anode plate 1618 that includes a plurality of openings 1613. A fluid channel 1615 is formed in plate 1618, and includes apertures in the sidewalls of each of the openings 1613. The fluidic channel is connected to an electrolyte reservoir 1617 via a tube 1619. During fabrication of dendritic structures, fluid reservoir 1617 delivers electrolyte materials (e.g., electrolyte solution) to each of the openings 1613 via fluid channel 1615.

Electrolyte delivery can also be accomplished using other anode geometries. For example, when anodes 1618 are implemented as a plurality of rings or tubes, electrolyte materials can be delivered to the substrate surface through apertures formed in the rings or tubes. The rings or tubes can be connected to an electrolyte reservoir in a manner similar to FIG. 16D.

By implementing the anodes 1618 as a plurality of tubes, rings, or similar structures, or as a plurality of openings in a metal plate, anodes 1618 form a dendritic structure “print head” that can be rapidly positioned and re-positioned on the surface of a substrate to facilitate high volume, high quality growth of dendritic structures. In some embodiments, anodes 1618 can also be used to cut substrate 1614 into individual pieces, each supporting a single fabricated dendritic structure. For purposes of cutting substrate 1614, the edges of the anodes 1618 that contact substrate 1614 can be sharpened to penetrate more easily into the substrate material. Cutting substrate 1614 in this manner can be highly advantageous, as the cutting process is automatically aligned with the sites at which dendritic structures are grown so that accurate sectioning of substrate 1614 can be achieved without performing any alignment steps.

When substrate 1614 includes an electrolyte layer or is pre-immersed in electrolyte solution, the electrolyte material remains in place following growth of the dendritic structures, unlike the methods disclosed in FIGS. 11A and 11B, for example, where the substrate is removed from the electrolyte bath following growth of the dendritic structures. In some embodiments, the composition of the electrolyte layer or electrolyte solution, the applied electrical potential difference, and/or the duration over which the potential difference is applied, are adjusted so that the dendritic structures grown on substrate 1614 remain essentially stable

(e.g., electrochemically stable), even in the later presence of the electrolyte layer or electrolyte solution.

Alternatively, in certain embodiments, the composition of the electrolyte layer or electrolyte solution, the applied electrical potential difference, and/or the duration over which the potential difference is applied, are adjusted so that during growth of the dendritic structures, the electrolyte layer or solution infused in substrate 614 is starved of metal from the anode, i.e., the rate at which metal atoms from the anode are oxidized and dissolve in the electrolyte layer or solution is insufficient to replace the metal cations that are reduced at the cathode. This can be achieved by limiting the amount of metal in the anode to less than the amount in the dendritic structure so that the dendritic structure grows at the expense of the metal ions in the electrolyte. The imbalance creates a chemical gradient between the dendritic structure and the electrolyte following growth, which will cause the dendritic structure to dissolve.

Following growth of the dendritic structures, the deficit of metal cations persists in the electrolyte layer or solution. Accordingly, the electrolyte layer or solution slowly dissolves the fabricated dendritic structures over a period of time, a process that is driven thermodynamically by the electrochemical and/or ionic imbalance in the electrolyte layer or solution. Thus, by fabricating dendritic structures in this manner, the structures can be made to “self-destruct” after a period of time. For structures that are used for identification or authentication, as will be discussed later, the structures can therefore be made to expire after a period of time. By adjusting the composition of the electrolyte layer or electrolyte solution, the applied electrical potential difference, and/or the duration over which the potential difference is applied, the expiration time of the fabricated dendritic structures can be controlled. For example, by using an electrolyte layer or electrolyte solution that is closer to saturation with respect to cations from the anode, the longer it will take for the electrolyte layer or electrolyte solution to dissolve the dendritic structures. The atomic percentage of metal in the electrolyte at saturation typically ranges from 70 atomic percent to 10 atomic percent, depending in the electrolyte; concentrations of metal cations smaller than the saturated concentration will cause gradual dissolution of the metal dendritic structures.

In some embodiments, the dendritic structures can be further processed (e.g., during or after fabrication) to enhance their features, in particular for imaging and/or packaging purposes. For example, one or more additional materials can be deposited atop the dendritic structures to

“smooth” the structures for packaging purposes. Examples of such materials include, but are not limited to, cyanoacrylate applied as a low viscosity (high-wicking) liquid and hardened by chemical reaction with water or UV exposure to form a hard acrylic coating, polymethylmethacrylate liquid or vapor hardened by chemical reaction with peroxide or UV exposure to form a hard Lucite<sup>®</sup> (Perspex<sup>®</sup>) coating, polyethylene terephthalate, polysiloxane liquid or condensed vapor that is thermally cured to give a silicate coating, silicon dioxide or silicon nitride deposited by the pyrolysis of vapor sources in a chemical vapor deposition reaction to create a highly conformal oxide or nitride film. Polymeric materials such as polyvinylchloride and cellulose acetate may also be applied as a tape, affixed with adhesive, to cover the dendrite.

In certain embodiments, to enhance the visibility of reflections from high points in the dendritic structures during imaging, the high points in the dendritic structures can be further “raised” above the surface of the substrate by applying an electric field during growth of the dendritic structures on the substrate. The field polarity is selected so that metal cations are drawn upward relative to the substrate surface due to the influence of the field, which yield dendritic structures that are more strongly peaked in a direction perpendicular to the substrate surface. Typical field strengths used for growing dendritic structures in this manner are in a range from 10,000 to 1,000,000 V/cm.

In some embodiments, fluorophores can be attached to the dendritic structures to produce light from the entire structure, which enhances visibility of the structures during image capture. Fluorophores can be attached over the entire dendritic structure, or attached selectively to certain regions of the structure such as high points (e.g., which appear as peaks under illumination). Fluorophore attachment can be performed by attaching an ionic group to the fluorophore and applying a voltage of the opposite polarity to the dendritic structure so that the charged fluorophores are particularly attracted to the regions of high electric field at the peaks of the dendritic structure.

The methods discussed in this section generally yield a plurality of dendritic structures fabricated in an ordered array on a substrate. Before the structures are used for various applications, however, a variety of additional processing steps can be performed. In FIG. 14, a processing station 1550 is positioned along the path of substrate 1514 between guide roller 1534 and product roller 1524. More generally processing station 1550 can be positioned at various

points along the path of substrate 1514 between feed roller 1522 and product roller 1524. In addition, in some embodiments, processing station 1550 can be positioned after product roller 1524, i.e., processing station 1550 can be positioned to process substrate 1514 after it has been spooled onto roller 1524.

5            Processing stations can generally be present in any of the fabrication systems disclosed herein. For example, the systems shown in FIGS. 11A, 11B, and 12-16A/B can each include a processing station for post-processing of fabricated dendritic structures. Each system can also include more than one processing station. For example, in some embodiments, similar processing stations can be used to process dendritic structures in parallel, thereby increasing the overall throughput of the fabrication systems. In certain embodiments, multiple processing stations can be used to perform different post-processing steps on the dendritic structures. These steps will be discussed further below. In general, the steps can be divided among any number of post-processing stations as desired.

15            FIG. 17 shows a schematic diagram of a post-processing station 1700 that can be used in any of the methods disclosed herein. Station 1700 includes a drying module 1702, an inspection module featuring an illumination source 1704 and an imaging detector 1706, a marking module 1708, a sealing module 1710, and a dicing module 1712. Substrate 1714 with dendritic structures fabricated thereon passes through some or all of these modules.

20            Drying module 1702 functions to dry the fabricated dendritic structures and substrate 1714 following growth. Drying module 1702 can be implemented in a variety of ways. In some embodiments, for example, drying module 1702 features one or more sources configured to direct flows of air (e.g., heated air) across the surface of substrate 1714. In certain embodiments, drying module 1702 includes one or more radiative sources, such as infrared sources, that direct radiation onto substrate 1714. The radiation heats substrate 1714 and can evaporate water and volatile substances from the substrate. In some embodiments, conductive and/or convective heating methods can be used in addition to, or as alternatives to, radiative heating. Further, heating methods that include radio frequency waves (e.g., microwaves) can also be used. Typically, the curing temperatures for dendritic structures are between 50° C and 250° C.

25            The inspection module allows a system operator to view the fabricated dendritic structures and, for example, to designate certain dendritic structures for rejection based on their morphology. In certain embodiments, an electronic processor 1716 coupled to illumination

source 1704 and imaging detector 1706 directs the light source to illuminate the dendritic structures on substrate 1714, and directs the imaging detector to obtain one or more images of the illuminated structures. Electronic processor 1716 then analyzes the images to the dendritic structures and applies rejection criteria to determine whether specific structures should be  
5 rejected. Dendritic structures can be rejected according to a variety of criteria. For example, specific dendritic structures can be rejected due to partial growth, a variety of morphological defects, and/or incorrect fractal dimension. Rejection can occur immediately by ejecting specific dendritic structures from the processing sequence, or the dendritic structures can be marked for later rejection. Rejection criteria can include, for example, the presence of defects that are larger  
10 than a threshold size (e.g., 0.1 mm), the absence of particular branches in the dendritic structures, and a fractal dimension that differs by 25% or more (e.g., 35% or more, 50% or more, 75% or more) from a target value. The target value for dendritic structures grown according to the methods disclosed herein is typically approximately 1.5

Marking module 1708 applies marks, e.g., fiducial marks, to regions of the substrate.  
15 The marks can be used for subsequent processing steps, such as dicing substrate 1714. Alternatively, fiducial marks can be applied so that the dendritic structures can be aligned for imaging, e.g., relative to a common reference position. Fiducial marks can be applied using methods such as photolithography and etching of a film, laser etching, embossing, cutting, and/or drilling of the substrate.

20 In some embodiments, fiducial marks can be added to the substrate by taking advantage of the photosensitivity of certain electrolytes in a photolithographic process. For example, silver nitrate will darken when exposed to light. Thus, a silver nitrate solution used as an electrolyte on a substrate can be exposed through a mask which contains a negative image of the fiducial pattern to create fiducial marks on the substrate. Exposure to create the fiducial marks can occur  
25 before or after growth of the dendritic structures.

Sealing module 1710 is configured to protect the fabricated dendritic structures by applying one or more layers of protecting materials over the dendritic structures. The protecting materials ensure that the dendritic structures are not subject to mechanical or chemical degradation during use. The protecting materials also are used to ensure that the fabricated  
30 dendritic structures are not subject to tampering to alter their structure. This can be particularly important for applications that involve identification and/or authentication, where the unique

morphologies of specific dendritic structures are tied to specific identity information. Methods for protecting the fabricated dendritic structures will be discussed in greater detail in a subsequent section.

Dicing module 1712 is configured to slice substrate 1714 into multiple pieces to separate  
5 the dendritic structures. Typically, for example, substrate 1714 is diced so that each of the fabricated dendritic structures is separated from the others. The dicing may be performed using methods such as cutting/guillotining by a blade, sawing, laser cutting, or punching. The separated individual structures are then used for a variety of applications, examples of which are described herein.

10 Although post-processing station 1700 includes a drying module 1702, an inspection module featuring an illumination source 1704 and an imaging detector 1706, a marking module 1708, a sealing module 1710, and a dicing module 1712, more generally the post-processing stations can include all or only some of these modules. Further, the modules can be arranged in any order; post-processing station 1700 in FIG. 17 is only one example of a suitable  
15 arrangement. In some embodiments, for example, the inspection module can be positioned after all of the other modules, i.e., after the dendritic structures have been dried, protected, and diced. Inspection can then proceed as described above to accept or reject the separated dendritic structures according to their specific morphologies. In certain embodiments, drying module 1702 can be positioned after sealing module 1710, particularly where sealing module applies one  
20 or more layers to the dendritic structures that require drying following deposition.

Marking module 1708 can generally be positioned anywhere along the processing sequence. For example, in some embodiments, marking module 1708 is positioned after dicing module 1712. Further, dicing module 1712 can also typically be positioned anywhere along the processing sequence. In certain embodiments, such as the example shown in FIG. 14, substrate  
25 1714 can be fed directly into dicing module 1712 (e.g., a cutting machine) rather than onto product roller 1524, to separate individual dendritic structures.

FIG. 18 shows a specific dendritic structure 1820 that has been grown and post-processed, including having been diced to separate it from other dendritic structures. Dendritic structure 1820 and the portion of substrate that supports it form a dendritic tag 1800 that is  
30 circular in shape. More generally, however, dendritic tags can have a variety of shapes, including square, rectangular, polygonal, elliptical, and various curved shapes. The maximum

dimension of the dendritic tags, which is the largest distance between any two points on the dendritic tags, is typically 5 mm or less (e.g., 4 mm or less, 3 mm or less, 2 mm or less, 1 mm or less).

## 5 Securing Dendritic Tags

Dendritic tags, fabricated as described in the preceding sections, have unique morphological features that make them useful for a variety of applications, in particular, applications that involve identification and authentication of articles. To be useful as unique identifiers, however, it is advantageous if the dendritic structures supported on the tags are  
10 difficult to tamper with following fabrication, and are sufficiently robust to retain their morphologies when exposed to a variety of physical and chemical environments. By rendering the dendritic structures difficult to modify or copy and the tags difficult to remove from articles to which they are applied, duplication or reuse of the tags for counterfeiting purposes is challenging and/or economically infeasible.

15 To prevent alteration of dendritic structure morphologies and to protect the fabricated tags against degradation in a variety of different environments, the present section discloses various systems and methods for treating fabricated dendritic structures. As discussed above in connection with FIG. 17, these treatments can be applied to fabricated dendritic structures by sealing module 1710. Alternatively, or in addition, the treatments can be applied using other  
20 means during or following fabrication of the structures.

To protect dendritic tags against environmental degradation, one or more layers of protective materials can be applied to encapsulate at least the tag's dendritic structure. FIG. 19 shows a schematic diagram of a dendritic tag that includes a substrate 1914 and a dendritic structure 1920 formed on the substrate. A protective layer 1902 is applied over dendritic  
25 structure 1920 to encapsulate the structure. Although protective layer 1902 is applied to only one surface of substrate 1914 in FIG. 19, more generally, protective layer 1902 can be applied to both surfaces of substrate 1914 to partially or fully encapsulate both substrate 1914 and dendritic structure 1920. Further, although a single protective layer 1902 is applied to the dendritic tag, more generally, one or more protective layers can be applied. Multiple protective layers can  
30 include different materials having different properties. For example, in some embodiments, a first protective layer can be applied to mechanical rigidity to the dendritic tag, and a second

protective layer can be applied to impart water impermeability to the encapsulated dendritic tag. The following discussion will focus on properties of protective layer 1902 for clarity. However, it should be understood that a variety of different combinations of layers, each having different properties, can be used to protect dendritic tags. In particular, combinations of any number of  
5 layers of any of the different materials disclosed herein can be used.

In certain embodiments, protective layer 1902 has a relatively high Mohs hardness number to resist mechanical abrasion of the encapsulated dendritic tag. In some embodiments, for example, the Mohs hardness number of protective layer 1902 is 4 or more (e.g., 5 or more, 6 or more, 7 or more, 8 or more). Further, in some embodiments, protective layer 1902 has  
10 relatively high water impermeability and degrades relatively slowly in sunlight. These properties of protective layer 1902 protect the encapsulated dendritic tag against environmental degradation.

In addition, in some embodiments, protective layer 1902 is relatively resistant to a variety of different classes of chemical compounds, including some or all of acids, chlorine-based  
15 compounds, bleaches, and detergents. The resistance of protective layer 1902 to these materials further protects encapsulated dendritic tags.

Protective layer 1902 is generally applied to dendritic tags in a manner that preserves the delicate dendritic structure 1920 on each tag. A variety of methods can be used for application of the protective layer. In some embodiments, for example, protective layer 1902 can be vapor  
20 deposited using chemical vapor deposition or physical vapor deposition techniques. In certain embodiments, protective layer 1902 can be applied as a low viscosity liquid to dendritic structure 1920 and the upper surface of substrate 1914.

Typically, both vapor and liquid deposition techniques are performed in a reduced-pressure environment to ensure that protective layer 1902 fills small gaps between the structural  
25 features of dendritic structure 1920. In some embodiments, for example, vapor and/or liquid deposition of protective layer 1902 is performed at an ambient pressure of 100 Torr or less (e.g., 50 Torr or less, 30 Torr or less, 20 Torr or less, 10 Torr or less, 5 Torr or less, 1 Torr or less, 500 mTorr or less, 300 mTorr or less, 100 mTorr or less).

Following deposition of protective layer 1902, in certain embodiments, the protective  
30 layer is hardened. Hardening of protective layer 1902 can be performed by physical or chemical techniques. Suitable physical techniques for hardening protective layer 1902 include directing a

flow of air onto protective layer 1902, heating the encapsulated dendritic tag to cure protective layer 1902, and/or photocuring protective layer 1902 by exposing protective layer 1902 to radiation, e.g., ultraviolet radiation. Suitable chemical techniques for hardening protective layer 1902 include, for example, exposing protective layer 1902 to chemical crosslinking agents such as formaldehyde.

In general, the material from which protective layer 1902 is formed is chosen for its particular physical and chemical properties to ensure that the dendritic tag it encapsulates is protected from degradation in a variety of different environments. A variety of different materials can be used singly, or in combination, to form protective layer. In some embodiments, protective layer 1902 includes cyanoacrylate, a low-viscosity liquid. A protective layer formed from cyanoacrylate can be hardened by chemical reaction with water and/or by exposure to ultraviolet radiation. Hardening yields a hard acrylic coating over dendritic structure 1920.

In certain embodiments, protective layer 1902 includes polymethylmethacrylate (PMMA), which can be deposited either as a vapor or a liquid onto the dendritic tag, and hardened by chemical reaction with a peroxide material or exposure to ultraviolet radiation. The hardened PMMA forms an acrylic layer that encapsulates dendritic structure 1920.

In some embodiments, protective layer 1902 includes polysiloxane, which can be deposited either as a vapor or a liquid onto the dendritic tag. Hardening of polysiloxane by thermal curing yields a silicate coating that encapsulates dendritic structure 1920.

In certain embodiments, protective layer 1902 includes polyethylene, e.g., polyethylene terephthalate (PET), which can be deposited either as a vapor or liquid onto the dendritic tag (e.g., as a monomer) and hardened by chemical reaction or exposure to heat or ultraviolet radiation. The hardened PET forms a layer that encapsulates dendritic structure 1920.

In some embodiments, protective layer 1902 includes silicon dioxide and/or silicon nitride. These materials can be deposited by pyrolysis of vapor sources in a chemical vapor deposition reaction, yielding a highly conformal oxide and/or nitride film that encapsulates dendritic structure 1920.

FIG. 20 shows a schematic diagram of another dendritic tag featuring a substrate 2014 and a dendritic structure 2020 formed thereon. In FIG. 20, the dendritic tag is not encapsulated by a protective layer 1902 deposited from vapor or liquid to form a conformal film on the dendritic structure. Instead, protective layer 2004 formed from a relatively soft, compliant

material that is applied as a solid film over the dendritic tag. The technique shown in FIG. 20 is particularly suitable for relatively robust dendritic structures that resist deformation, as the application of protective layer 2004 exerts a downward force on dendritic structure 2020.

Dendritic structure 2020 is sandwiched between protective layer 2004 and substrate 2014  
5 in FIG. 20, and may not be fully coated by protective layer 2004 (i.e., not all portions of dendritic structure 2020 may be in contact with protective layer 2004). Voids between protective layer 2004 and dendritic structure 2020, such as voids 2006 and 2008, may trap gases or may enclose volumes in which the pressure is reduced relative to ambient pressure. Following application of protective layer 2004 to the dendritic tag, the protective layer can be hardened  
10 using any one or more of the physical and chemical methods disclosed above.

A variety of materials can be used to form the solid protective layer 2004 that is applied to the dendritic tag. Suitable materials include, but are not limited to, acrylic, polycarbonate, PMMA, PVC, and/or glass.

Following application of one or more protective layers, the encapsulated dendritic tag is  
15 protected from physical and chemical degradation by the environment, but is accessible for optical measurements and is also electrically (e.g., capacitively) addressable. As such, the dendritic tag can function as an identifier containing information that can be “read” by optical and electrical methods.

To duplicate the morphology of a specific dendritic structure on a tag, contact molding is  
20 the process most likely to be successful, as molding can replicate complex, minute structural features. To perform contact molding of dendritic structures, which have three dimensional shapes, the protective layer(s) must be removed from the structures. Removal might be attempted by either physical or chemical methods. However, because dendritic structures typically have Mohs hardness values of less than about 2.5, the encapsulated tags are likely to be  
25 damaged by physical attempts to remove the one or more protective layers from the tags. As such, physical tampering with the structures is effectively precluded by the fragility of the structures.

Chemical attempts to remove the one or more protective layers are also likely to result in damage to the dendritic structure, as the protective layers are considerably more chemically inert  
30 than the encapsulated dendritic structure, which has a high surface area. Accordingly, chemical methods for removing the protective layers are unlikely to succeed without damaging the

dendritic structures, and because both chemical and physical methods for removal are likely to fail, tampering with the encapsulated dendritic structure – including contact molding of the structure – is effectively precluded.

Another technique that might be attempted to duplicate dendritic tags involves optically  
5 scanning an intact tag and then duplicating the tag using methods such as printing. However, these methods are effectively precluded by the complex morphology of the dendritic structures in the tags. FIGS. 21A-C show a series of micrographs of dendritic structures grown on a substrate with an overlying liquid electrolyte. The magnification increases from FIG. 21A through FIG. 21C. As is evident from these figures, the morphology of the dendritic structures is complex and  
10 three dimensional, and extends to nanoscale dimensions. Morphologies of dendritic structures in the direction perpendicular to the substrate surface typically differ, depending upon whether the electrolyte used during fabrication was in solid form, or in liquid or gel form. Typically, liquid- or gel-based electrolytes yield dendritic structures with significant growth along the perpendicular direction, as shown in FIGS. 21A-C. In contrast dendritic structures grown using  
15 a solid electrolyte typically have a “terrain-like” or “mountainous” shape in the perpendicular direction, as shown in the examples of FIGS. 22A and 22B.

The three dimensional morphology of the dendritic structures makes replication by top-down methods very difficult. Moreover, three dimensional printers do not have resolutions sufficient to replicate nano-scale features of dendritic structures. As such, the fractal complexity  
20 of the dendritic structures effectively preclude replication of the structures using conventional methods. Further, application of one or more protective layers using the methods disclosed herein can lead to minor, but unpredictable, distortions of dendritic structures. Even if methods were developed for the duplication of such structures, the duplicate structures would not necessarily undergo similar distortions when one or more protective layers are applied. This  
25 element of unpredictability further ensures that duplication of the encapsulated dendritic tags is highly difficult.

The encapsulated dendritic tags disclosed herein can be used for identification and authentication of articles such as commercial goods. In such applications, the tags are typically bonded to an outer surface of the articles. Removal of the tags from the articles to which they  
30 are affixed for purposes of engaging in fraudulent activity is therefore an important consideration. A variety of methods might be considered to effect such removal, including

mechanical (i.e., physical) methods where a dendritic tag is carefully peeled, scraped, or cut from the article, thermal methods where heat is applied to the bond between the tag and the article to weaken the bond and separate the tag from the article, and chemical methods in which a chemical agent such as a solvent or acid is used to soften or remove the bond between the tag and the article. However, each of these methods typically fails, as each method generally destroys the dendritic structure underneath the one or more protective layers.

Destruction of a dendritic tag in the event an attempt is made to remove the tag from an article to which it is affixed provides a convenient method for ensuring that tags remain associated with the articles to which they are applied, and are not applied to other articles. A variety of additional steps can also be taken to ensure that attempts to remove a tag from its associated article results in partial or complete destruction of the dendritic tag.

In some embodiments, to prevent removal of applied dendritic tags, a strong bonding agent is used to affix dendritic tags to specific articles. The bonding agent can be, for example, a chemical adhesive, a thermal bonding material, and/or an ultraviolet light-activated bonding agent.

The bonding agent used to affix dendritic tags to particular articles unites the tags and articles via bonds that are stronger than the shear strength of the tags. As a result, attempts to remove the tags from the articles to which they are bonded typically result in tearing of the tags. In the encapsulated tags, the dendritic structures are typically positioned within 50 microns (e.g., within 40 microns, within 30 microns, within 20 microns) of the adhesive layer to prevent sectioning of the tag between the adhesive layer and the dendritic structure, which might allow the dendritic structure to be removed from the article to which it is affixed in intact form.

In some embodiments, a portion of the dendritic structure in a tag can be bonded directly to an article to ensure that attempts to remove the tag from the article results in destruction of the tag's dendritic structure. FIG. 23 is a schematic diagram showing a dendritic tag 2140 bonded to an article 2112 using a layer of adhesive 2110. Dendritic tag 2140 includes a substrate 2114 that supports a dendritic structure 2120, and a protective layer 2102.

As shown in FIG. 23, a portion of substrate 2114 has been removed, so that a portion of dendritic structure 2120 is bonded directly to article 2112 via adhesive 2110. As a result of the direct bond between dendritic structure 2110 and article 2112, attempts to remove dendritic tag

2140 from article 2112 are likely to result in damage to, or destruction of, dendritic structure 2120.

Although only a single portion of substrate 2114 has been removed to allowing bonding of dendritic structure 2120 to article 2112 in FIG. 23, more generally, one or more portions can be removed. The removed portions can be arranged in any desired pattern on substrate 2114. Suitable patterns can include two-dimensional array patterns (e.g., criss-crossing patterns), for example. In certain embodiments, substrate 2114 can be removed entirely and the entire dendritic structure 2120 can be bonded to substrate 2114. Portions of the substrate may be removed using techniques such as cutting, scribing, etching, and/or laser ablation.

In certain embodiments, similar (or the same) materials are used to form both protective layer 2102 and the adhesive layer that bonds dendritic tag 2140 to article 2112. By using similar or the same materials, if attempts are made to chemically dissolve or thermally soften the adhesive layer, damage will also occur to protective layer 2102, and to dendritic structure 2120. In some embodiments, for example, protective material 2102 and the adhesive layer are formed from a cyanoacrylate liquid, which is cured by a chemical reaction with water vapor in the environment. In certain embodiments, protective material 2102 and the adhesive layer are formed from a UV curable adhesive material.

In some embodiments, adhesive is applied in a patterned geometry between dendritic tag 2140 and article 2112. The adhesive pattern can include, for example, a series of dots, stripes, or another regular or irregular pattern. By applying adhesive in a pattern, certain portions of dendritic tag 2140 are bonded more firmly to article 2112 than other portions. As a result, physical removal attempts are more likely to cause distortion or breakage of dendritic tag 2140.

In certain embodiments, substrate 1114 can be patterned or roughened. FIG. 24 is a schematic diagram of a dendritic tag 2140 bonded with adhesive 2110 to an article 2112. The surface of substrate 2114 that is bonded to article 2112 is patterned with a series of grooves that are not completely filled by adhesive 2110. As a result, the groove portions of substrate 2114 are not bound as firmly to article 2112 as the other portions of substrate 2114. Due to this uneven adhesion, attempts to physically remove tag 2140 from article 2112 are more likely to lead to distortion or breakage of tag 2140.

In general, a variety of different types of patterned substrates can be used in FIG. 24. For example, in some embodiments, the patterned substrate features a plurality of grooves and/or

recessed circular or elliptical regions. The pattern features can generally be arranged regularly on substrate 2114 or in a random pattern.

In some embodiments, dendritic tag 2140 includes one or more mechanical defects deliberately introduced into the tag during fabrication so that if an attempt is made to remove the tag from the article to which it is attached, the tag will tear. The mechanical defects can include a variety of scores, cuts, and other structural defects. FIG. 25 is a schematic diagram of a dendritic tag 2140 that includes a plurality of cuts 2142 introduced so that a force is applied to the tag (e.g., in an effort to peel it away from an article to which it is attached), the tag ruptures along one or more of the cuts.

In certain embodiments, dendritic tags can be positioned in recesses formed in articles to make removing the tags more difficult. FIG. 26 is a schematic diagram showing a dendritic tag 2140 positioned in a recess 2160 of an article 2112. By positioning tag 2140 in recess 2160, application of prying tools to peel the tag from the substrate is made more difficult. A variety of different recess cross-sectional shapes can be used, including square, circular, rectangular, elliptical, and polygonal. In some embodiments, recesses with overhanging edges can be used, as these can be particularly effective at preventing prying of the tag from the article.

In some embodiments, additional materials can be included within the structure of dendritic tags to trigger destruction of the tags if tampering occurs. For example, FIG. 27 shows an embodiment of a dendritic tag 2140 bonded to an article 2112. Encapsulated by protective layer 2102 are dendritic structure 2120 and reactive materials 2170. Reactive materials 2170 can include any one or more of a variety of materials that react when exposed to the environment around tag 2140 (e.g., to air or water vapor in the environment). If an attempt is made to remove protective layer 2102 from tag 2140, reactive materials 2170 are exposed and react, destroying dendritic structure 2120 (e.g., by dissolving, discoloring, distorting, or destroying the morphology of dendritic structure 2120) so that it cannot be duplicated.

A variety of different reactive materials can be used as shown in FIG. 27, including solids, liquids, and gases. Examples of reactive materials that can be used include, but are not limited to, mild acids, oxidizers, and/or sulfidizing agents.

The reactive materials can also be arranged in a variety of ways in tag 2140. In some embodiments, for example, reactive materials 2160 are arranged in discrete regions, as shown in FIG. 27. In certain embodiments, reactive materials 2160 are dispersed within one or more

components of the tag, such as within protective layer 2102. Tags with reactive materials can be fabricated using a multi-step encapsulation process following formation of the dendritic structures. First, the dendritic structure is coated to protect it, then a fragile blister that includes the reactive material is applied, and the dendritic structure on its substrate and the blister are  
5 encapsulated together. Alternatively, in some embodiments, the substrate is formed so that the reactive material is contained in a pocket or blister underneath the locations where dendritic structures are to be grown; once grown on top of the pockets or blisters, the dendritic structures and reactive materials are encapsulated together to form the tag.

In some embodiments, a covert tagging procedure can be used to apply dendritic structure tags within a material or underneath the surface of a material so that the structure is not visible  
10 on the material surface. Instead, a portion or all of the dendritic structure can be hidden within or behind the material.

As described previously, metallic dendritic structures can be grown within a porous substrate such as filter paper or microfiber cloth by soaking the substrate material with a liquid  
15 electrolyte solution and then contacting the material with at least one anode and at least one cathode. When an electrical potential is applied between the anode(s) and cathode(s), dendritic structure growth occurs.

FIG. 67 is an image showing an example of a copper dendritic structure that has been grown using such methods. Portions 6702 of the structure grown at the surface are distinctly  
20 visible, whereas sub-surface portions 6704 and deep sub-surface portions 6706 are less visible, so that the fine detail of the dendritic structure is obscured even at high magnification under an optical microscope.

In embodiments where the dendritic structure is grown or applied to a rigid or semi-rigid substrate such as a plastic substrate (e.g., a credit or access card), a thin (e.g., less than 100  $\mu\text{m}$   
25 thick) dyed plastic layer can be applied over the dendritic structure and fixed in place with adhesive. Such layers are commonly used during card fabrication to add graphical elements and/or security features (e.g., holographic features) to the surface of cards, and can also be used to hide the presence of dendritic structures. Suitable materials that can be used for such layers include, for example, polyvinyl chloride acetate (PVCA).

Dendritic structures applied to such substrates can be scanned using infrared light.  
30 Because such light is not visible to the human eye, even the scanning process can be performed

covertly in certain embodiments. In general, the dendritic structures can be imaged with light having a central wavelength between about 750 nm and about 2000 nm. Light within this wavelength range will readily pass through one or more plastic overlayers.

In some embodiments, the dendritic structures can alternatively or additionally be scanned using capacitive scanning methods. Suitable capacitive scanning methods have been described above.

### Commercial Applications

The dendritic tags disclosed herein feature dendritic structures, no two of which are precisely identical. Because each dendritic structure is unique, a tag containing the structure can be affixed to an article to act as a “fingerprint” that uniquely identifies the article. Moreover, because dendritic tags can be economically fabricated in large volumes and protected against degradation, duplication, and removal, they are particularly well suited for use in commercial transactions, where identification and authentication of goods is of great importance to many commercial entities.

FIG. 28 is a schematic diagram showing a flow chart 2200 that includes a series of steps for identifying and authenticating goods using dendritic tags. In a first step 2202, a dendritic tag (e.g., any of the dendritic tags disclosed herein) is applied to an article to uniquely mark the article. Any of the methods disclosed herein can be used to apply the tag to the article, including, for example, bonding the tag to the article using a layer of adhesive material.

After the tag is applied to the article, the tag is scanned in step 2204, and information about the tag that is obtained from the scan is stored, along with information about the article, in an electronic record. Methods for scanning a dendritic tag and for obtaining information about the tag from such scans are discussed in a subsequent section. Typically, the information about the tag includes information about one or more morphological features of the tag that can be used to rapidly identify the tag.

The electronic record that is created includes both the tag information and information about the article, such as the type of article, information about one or more of its properties (e.g., size, shape, color, manufacturing origin, lot or identity number), and information that is used for inventory control (e.g., an inventory control number, warehouse location, inventory check-in and/or check-out dates). Typically, the electronic records are stored in a database (e.g., a secure

database) that is accessible over a network. A variety of different networks can be used to access the database, including WiFi networks, cellular data networks, wired networks, wide-area networks, and the internet.

Tracking of tagged articles can be performed for a variety of reasons. In some  
5 embodiments, for example, the tagged article is moving through a portion of a corporation's supply chain, e.g., from a storage facility to a manufacturing site, from a factory to a storage warehouse, from a factory to a retail location, from a factory or warehouse to a distribution facility, from a first factory to a second factory, or even between two locations at the same site, e.g., between two locations on a manufacturing or assembly line. In certain embodiments, the  
10 tagged article is being transferred from a seller of the article to a purchaser of the article. In some embodiments, the tagged article constitutes raw material for a manufacturing process, and is being transferred to an entity that is contracted to refine the raw material.

In the foregoing and other scenarios, the tagged article, after being scanned and the scan information stored, is transferred to the recipient of the article in step 2206. Then, in step 2208,  
15 the recipient scans the dendritic tag applied to the article in a manner similar to step 2204. The scan is analyzed to determine information about the tag, in a manner similar to the manner in which the tag information is determined in step 2204.

Next, in step 2210, the previously scanned tag information is obtained. In some  
20 embodiments, such as when the tagged article is being transferred between two points in a single entity's supply chain, both the sender and recipient of the tagged article will have access to the same secure database where the tag information is stored, and so the previously scanned tag information can simply be retrieved from the database. This scenario applies, for example, when the tagged article is transferred from an entity's manufacturing facility to a storage, distribution, or retail facility. When the tagged article is scanned upon receipt in step 2208, other information  
25 about the article, such as the article's location, condition, inventory information, and/or price, can be entered into the database to update the article's electronic record.

If the tagged article is transferred to a retail facility, the owner of the article (e.g., the seller) may allow potential buyers of the article to scan the tag applied to the article and to access the owner's database to obtain the previously-scanned information about the tag. This permits  
30 potential buyers to verify for themselves that the article is genuine.

If the tagged article is being transferred from one entity to another, separate entity (e.g., in a commercial transaction between a seller and a buyer, such as a transaction that occurs over the internet), the initial scan and determination of tag information would be performed by the seller, and the subsequent scan and determination of tag information would be performed by the  
5 buyer. In this scenario, the seller would have to be trusted to reliably provide the previously-determined tag information at a later date.

A variety of different methods can be used to ensure that the seller reliably provide this information. In some embodiments, for example, sellers can be certified by an independent monitoring authority and monitored for compliance with a business code of conduct. Buyers  
10 would therefore receive some assurance that sellers who receive this certification can be trusted to provide the previously scanned tag information.

Suppliers can also be certified by an independent authority. For example, in transactions where a buyer purchases an article from a first commercial entity (i.e., the seller) and the article is shipped directly to the buyer from a second commercial entity (i.e., the supplier), the supplier  
15 performs the initial scan of the tag applied to the article in step 2204. The buyer, who receives the article from the supplier, performs the second scan of the tag in step 2208. As described previously, the supplier is trusted to provide the previously scanned tag information on demand to verify the authenticity of the article.

Next, in step 2212, the previously scanned tag information (i.e., from step 2204, provided  
20 in step 2210) is compared to the scanned tag information determined in step 2208 to identify the tagged article. In some embodiments, the comparison can be performed by the recipient of the tagged article. For example, the same device used to scan the tag and determine the tag information in step 2208 can be used to compare the tag information to previously-determined tag information to identify the tagged article. The device can include an electronic processor  
25 executing software instructions that perform this comparison.

Alternatively, in some embodiments, the recipient of the tagged article can transfer the scanned tag information determined in step 2208 to a different device, such as a remote computer, that performs the comparison. The information can be transferred over a network,  
e.g., any of the previously described networks, or over a direct wired connection to the computer.  
30 The remote computer includes an electronic processor executing software instructions that perform the comparison. In certain embodiments, the remote computer is owned by the recipient

of the tagged article. In some embodiments, however, the remote computer is owned by a separate entity, such as a transaction clearinghouse, that performs the comparison and reports the results to the recipient (and, optionally, to the seller or supplier of the tagged article).

In the event the identity of the article is confirmed by the comparison in step 2212, the transaction between the sender and recipient of the tagged article is concluded. However, if the identity of the article is not confirmed (e.g., the comparison of the previously determined tag information and the newer tag information does not yield a match), then the recipient and sender of the tagged article can take further steps to resolve the discrepancy. The steps can include, for example, return of the tagged article to the sender. In either scenario, the process shown in flow chart 2200 terminates at step 2214.

At steps 2204 and 2208 in flow chart 2200, the dendritic tag applied to the article is scanned to obtain tag information. The scanning step can be performed in a variety of locations, including on a manufacturing or assembly line, in a packing facility, on a shipping and/or receiving dock, in a warehouse, in a retail location, and in a buyer's home. As such, a variety of different devices can be used to scan and determine tag information. For example, in some embodiments, a dedicated scanning device is used. The scanning device can be an automated device that automatically scans tagged articles as they move through a manufacturing or warehouse facility. Alternatively, the scanning device can be a portable, handheld device.

FIG. 29 is a schematic diagram of an embodiment of a scanning device 2300 for scanning a tagged article and determining tag information. In FIG. 29, an article 2350 with a dendritic tag 2360 applied thereto is positioned in proximity to scanning device 2300. Device 2300 includes an optional radiation source 2302, optional illumination optics 2304, optional imaging optics 2306, a detector 2308, an electronic processor 2310, and a receiver/transmitter 2314. These components are enclosed within housing 2316. Device 2300 can optionally include a display 2312. An activation switch 2318 is optionally mounted to housing 2316. Radiation source 2302, detector 2308, receiver/transmitter 2314, display 2312, and switch 2318 are connected to electronic processor 2310. Not shown in FIG. 29 is a power source (e.g., an AC power connection, or a portable power source such as a battery) that provides electrical power to the components of device 2300.

Scanning of tag 2360 is typically initiated when a user of device 2300 activates switch 2318. In embodiments where device 2300 is an automated scanner, initiation of a scan can

occur, for example, when article 2350 passes through a specific location on a manufacturing or assembly line, triggering an external switch connected to electronic processor 2310.

When a scan is initiated, electronic processor directs radiation source 2302, if present in device 2300, to illuminate article 2350 (and tag 2360) with light through aperture 2320. Light  
5 reflected from tag 2360 (i.e., illumination light and/or ambient light) enters housing 2316 through aperture 2322, and is collimated and imaged by imaging optics 2306 onto an active surface of detector 2308. Detector 2308 captures an image of tag 2360 which is then transferred to electronic processor 2310. Electronic processor 2310 can optionally analyze the tag image to extract tag information. The image and/or the extracted tag information is transferred to a  
10 database by electronic processor 2310 using transmitter/receiver 2314.

When display 2312 is present in device 2300, electronic processor 2310 can also display a variety of messages on display 2312 to advise the user of device 2300 of the progress of the scanning operation. Messages can advise the user, for example, that a scan has been initiated, that the tag image has been acquired, and that tag information extracted from the image is being  
15 transferred to a database. As will be explained in greater detail subsequently, display 2312 can also be used to display messages alerting the user that previously scanned tag information is being obtained from a database, that the previously scanned tag information is being compared to more recently scanned tag information, and the results of the comparison to determine authenticity of the tagged article.

Radiation source 2302 can typically include any one or more of a variety of light sources  
20 such as, for example, incandescent, fluorescent, LED-based, and/or laser-based sources. Detector 2308 can include one or more imaging detectors, such as detectors based on a charge-coupled device (CCD) and/or detectors based on a complementary metal-oxide semiconductor (CMOS) array. Transmitter/receiver 2314 typically features components, including signal  
25 modulation and demodulation components, that permit communication of information, e.g., in packet form, over one or more wired or wireless networks or interfaces including, for example, WiFi networks, Bluetooth® networks, local area networks, wide area networks, the internet, cellular data networks, and direct wired connections to other devices.

In some embodiments, dendritic tags applied to articles can be scanned using mobile  
30 telephones. For example, an application running on a mobile telephone's electronic processor can use the telephone's built-in camera to acquire an image of a tag attached to an article. The

telephone's electronic processor can optionally analyze the image to extract tag information, and then transfer the tag information and/or the image to a database over a wireless cellular data network using the telephone's built-in transceiver.

5 Because dendritic structures have considerable structural detail and complexity that can be used as unique identifying information, the standard camera in a mobile telephone may not be able to capture images with sufficient resolution to provide tag information of sufficient quality for purposes of authenticating tags. In certain embodiments, an enhanced imaging module can be used together with a mobile telephone to yield images with enhanced resolution.

10 FIG. 30 is a schematic diagram showing a detachable imaging module 2408 connected to a mobile telephone 2402 for scanning tagged articles. Mobile telephone 2402 includes an image sensor 2406 and, optionally, a flash unit 2404. Module 2408 can connect to mobile telephone 2402 using a variety of mechanisms. In some embodiments, for example, module 2408 snaps onto the housing of mobile telephone 2402; the interference fit ensures that module 2408 remains in position relative to telephone 2402 while tagged articles are scanned. In certain embodiments, 15 module 2408 can be attached to the mobile telephone 2402 using clips, temporary adhesives, and/or magnets.

Module 2408 includes a lens 2412 and, optionally, a waveguide 2410. Lens 2412 is positioned within module 2408 so that when module 2408 is connected to mobile telephone 2402, lens 2412 aligns with image sensor 2406. In this manner, lens 2412 can provide enhanced 20 imaging of objects (i.e., enhanced relative to images that would be obtained using only the mobile telephone's image sensor 2406 and internal optics). Although lens 2412 is depicted as a single optical element in FIG. 30, more generally lens 2412 can include one or more optical elements. For example, in some embodiments, lens 2412 can be a compound lens that includes two or more optical elements. Each of the one or more optical elements of lens 2412 can be 25 formed from a variety of materials including various amorphous optical glasses (e.g., fused silica), various crystalline materials (e.g., quartz, calcium fluoride), and various plastic materials (e.g., polycarbonates, acrylics).

Module 2408 also optionally includes a waveguide 2410. Waveguide 2410 is positioned within module 2408 so that when module 2408 is connected to mobile telephone 2402, 30 illumination light generated by the mobile telephone's flash unit 2404 (if present) is coupled into waveguide 2412 and directed to be incident on an object to be imaged. Waveguide 2410 can be

formed from a variety of optical materials including, for example, any of the materials disclosed above in connection with lens 2412.

Although the foregoing optical elements are part of module 2408 in FIG. 30, in some embodiments, some or all of the optical elements can be built into the mobile telephone housing. For example, lens 2412 and/or waveguide 2410 can be integrated within the housing of mobile telephone 2402.

In some embodiments, certain exterior surfaces of waveguide 2410 can be coated with reflective optical materials to enhance the confinement and guiding of light from flash unit 2404 within the waveguide. For example, in FIG. 30, a reflective coating 2414 is applied to a portion of the downward-facing surface of waveguide 2410. The uncoated surfaces of waveguide 2410 can function as apertures through which light can be coupled into waveguide 2410 (e.g., light 2420 generated by flash unit 2404) or coupled out of waveguide 2410 (e.g., light 2422 that is incident on dendritic tag 2416 applied to article 2418). In general, a variety of reflective materials can be used to coat surfaces of waveguide 2410. Suitable examples include, but are not limited to, metallic materials such as aluminum, silver, gold, and nickel, and reflective dielectric multilayer materials.

Although waveguide 2410 is rectangular in shape in FIG. 30, more generally, waveguide 2410 can have a variety of shapes. In some embodiments, for example, waveguide 2410 can be tapered laterally in the direction toward lens 2412 (i.e., in the direction from left to right in FIG. 30). Tapering waveguide 2410 in this manner can produce brighter illumination over a smaller spatial region by confining the guided light rays spatially. Enhanced illumination can be useful, for example, when imaging tagged articles in environments where ambient light is low.

Scanning of dendritic tag 2416 is typically initiated by a user of mobile telephone 2402. In some embodiments, the user can acquire one or more images of dendritic tag 2416 using the mobile telephone's software. That is, by connecting module 2408 to mobile telephone 2402 and then activating the telephone's image capture software, images of sufficient quality for dendritic tag analysis can be obtained. Alternatively, in some embodiments, a specialized application can be provided on mobile telephone 2402. By activating an on-screen control provided by the application, the user can initiate image capture by sensor 2406. Images of tag 2416 obtained using either of the foregoing methods can be stored in mobile telephone 2402 (i.e., in a memory

unit of the telephone and/or in an on-board storage unit, such as a flash memory device) for further processing.

In some embodiments, imaging of dendritic tag 2416 can be facilitated by providing an optical element such as a lens on the surface of tag 2416. FIG. 31A is a schematic diagram of an article 2418 that includes a dendritic tag 2416. Dendritic tag 2416 includes a dendritic structure 2430 enveloped in a protective layer 2432. To facilitate imaging of dendritic structure 2430, a lens 2434 is formed in protective layer 2432. Lens 2434 can include a variety of different types of lenses including, for example, curved lenses (i.e., concave and/or convex lenses) and Fresnel lenses.

In general, lens 2434 is integrally formed in protective layer 2432. Various techniques can be used to form lens 2434. In some embodiments, for example, lens 2434 can be molded into protective layer 2432 as protective layer 2432 is applied over dendritic structure 2430. Lens 2434 can be molded, for example, using a form, having the inverse shape of the lens, which is pressed into the protective layer material prior to hardening so that the material takes on the shape of the lens. In certain embodiments, lens 2434 can be formed in protective layer 2432 after the protective layer has been applied over dendritic structure 2430. Various methods can be used to form lens 2434 including, for example, mechanical cutting and/or grinding of protective layer 2432, ion etching of protective layer 2432, liquid-phase etching of protective layer 2432, and/or laser ablation of protective layer 2432. Computer-based machining systems that include three-axis robotic positioning systems can be used to accurately etch, cut, or grind protective layer 2432 using the foregoing methods.

In some embodiments, to facilitate imaging of dendritic structures, a lens can be applied to the protecting layer that encapsulates the dendritic structure in a dendritic tag. FIG. 31B is a schematic diagram showing an article 2418 that includes a tag 2416. Dendritic tag 2416 includes a dendritic structure 2416 and a protective layer 2432. Further, lens 2436 is applied to a surface of tag 2416. Lens 2436 can include a variety of different types of lenses including, for example, curved lenses (i.e., concave and/or convex lenses) and Fresnel lenses. Various methods can be used to attach lens 2436 to protective layer 2432. In some embodiments, for example, lens 2436 is glued to protective layer 2432 using an adhesive material. The adhesive material can, for example, be an optical adhesive.

In certain embodiments, dendritic structures can be “imaged” electronically. For example, a capacitive array detector with a protective coating that functions as a dielectric layer between the array detector and the dendritic structure can readily be used to map the surface relief of the dendritic structure. Using such methods, features that are “higher” (e.g., extend  
5 further in a direction perpendicular to the general plane of the dendritic structure) have higher capacitance values, as they are closer to the capacitive array. Examples of methods for capacitive reading of dendritic structures are described above.

In some embodiments, dendritic tags can be used to secure articles against tampering. Tampering can include, for example, attempts at altering the contents of a package, improperly  
10 modifying an article, and reverse-engineering an article. The dendritic tags disclosed herein can make these actions difficult, prohibitively expensive, and difficult, so that attempts to do so are effectively discouraged.

In anti-tampering applications, a dendritic tag is applied to secure an article and scanned into a secure database, as discussed above, so a one-to-one mapping exists in the database  
15 between the specific structure of the tag and the article. The tag is applied to the article in the form of a seal over an opening in the article’s housing or packaging so that unauthorized access to the interior of the article, e.g., disassembly of the article, will damage the tag. When the tag is re-scanned for purposes of identification, the damage to the tag will have altered its structure in a manner that prevents successful identification. Further, the complex, three-dimensional structure  
20 of the tag ensures that it cannot easily or economically be duplicated. Thus, tampering with the article cannot be masked by fraudulent copying of the dendritic tag seal. At the same time, authorized maintenance performed on the article can be accompanied by replacement of the tag with a new tag, which is scanned into the database and associated with the article, replacing the record of the old tag.

25 Dendritic tags can be placed in a variety of ways to enhance anti-tampering protection, depending upon the nature of the article to be secured. For example, for articles that include a casing or housing, tags can be positioned across a break or seam in the casing (either externally or internally) so that opening of casing, e.g., by removing an access panel, will break, damage, or distort the tag. For fasteners such as screws, bolts, and rivets that are installed in an article, tags  
30 can be positioned on the head of the fastener so that significant force cannot be applied to the

fastener without damaging the applied tags. The tags can also be applied such that they bridge the fastener head to a surface, so that removal of the fastener would break the tag.

In some embodiments, where the article includes a socket (e.g., an electrical and/or data socket such as a USB port), the tags can be applied across the socket either internally or  
5 externally to secure the socket. If a member, such as a connector, is inserted into the socket, the tag will be damaged. Similarly, a tag can be applied to bridge the socket and an inserted connector so that if the connector is removed, the tag will be damaged. In certain embodiments, where the article includes a valve, a switch, or a similar control device, tags can be applied to the control device so that if the setting of the device is changed, the applied tag will be damaged.

10 As discussed above, in some embodiments, dendritic structures in tags can be fabricated so that they are degraded by exposure to light, heat, or various chemical substances. These properties can be applied to secure tagged articles against tampering. For example, silver dendritic structures, when exposed to light, typically partially dissolve into electrolyte films, which results in significant distortion of the structures. A dendritic tag with a silver dendritic  
15 structure can therefore be applied to secure a critical component of an article against tampering, e.g., by positioning the tag inside the critical component so that opening the component's housing would expose the tag to light. Scanning of the exposed tag would reveal the distorted dendritic pattern, indicating possible tampering with the component.

In certain embodiments, a dendritic tag applied to secure an article can be chemically  
20 sensitized so that it reacts with substances that are commonly used to etch through coatings or housings of the article. If the region of the article where the tag is applied can be evacuated, the tag can be sensitized to react in air. Reaction of the tag in air or to etching substances will distort the tag's dendritic structure, indicating possible tampering with the article.

In some embodiments, a dendritic tag applied to secure an article can be fabricated in a  
25 manner such that when heated, the tag distorts, causing disruption to its dendritic structure. For example, the dendritic structure can be supported by a material (e.g., a plastic material) which exhibits hysteresis upon heating, and does not return to its original size and shape. Distortion of the tag, such as when the article is heated to cause damage or obtain access thereto, is indicated by the disruption to the tag's dendritic structure.

30 In certain embodiments, the dendritic tags disclosed herein can be used to track and secure a wide variety of foodstuffs, both manufactured and harvested. Spoilage and

contamination of food, and food poisoning via ingestion of spoiled and/or contaminated food, are worldwide problems that can affect large numbers of people in relatively concentrated geographic regions when delivery of such foodstuffs occurs. For purposes of tracking food inventory to its source, existing RFID tags are relatively costly, which precludes tagging each  
5 food item. Instead, tagging generally occurs at the pallet or shipment level. As a consequence, the granularity of tracking is relatively coarse; individually packed items typically cannot be tracked.

The cost of RFID tags and their accompanying tag-reading technology has delayed deployment for purposes of food tracking. At present, only a few major producers or suppliers  
10 have incorporated the technology into their supply chains. This patchwork deployment allows spoiled and contaminated foodstuffs to be offered for sale, and makes tracking such items difficult, since many will originate from suppliers who have not implemented reliable tracking technologies.

In contrast, the dendritic tags disclosed herein can be used to track and secure a wide  
15 variety of food items at low cost, using methods that are easy, straightforward, and reliable to implement. Using the tags disclosed herein to track such items increases the speed and efficiency of tracking, and also provides tracking results of significantly higher granularity than other methods, even allowing tracking of individually packed items and/or individual items within packages. As the tags are highly economical to produce and unique, then can be attached  
20 to individual food items, to subsets of items in a batch, and/or to packaging.

Using readily available devices (e.g., a smartphone-based scanner, or a dedicated handheld scanner), food inspectors, suppliers, wholesalers, and even consumers can scan the tags applied to food items to obtain information about the items stored in database records. The information can include recall notices, information about the origin, date of manufacture, date of  
25 packaging, freshness, and even health-related information such as warnings about consuming the food items together with incompatible items such as certain medications. A software application implemented on the smartphone or handheld scanner can be linked to the database to retrieve and display the information to the operator of the smartphone or scanner.

In certain embodiments, “expiring” dendritic tags can be fabricated to provide additional  
30 information to food handlers, sellers, and consumers. For example, through judicious choice of materials, dendritic tags that are destroyed by similar biochemical environments that cause food

spoilage can be fabricated. Thus, when the food items to which the tags are applied begin to spoil due to their biochemical environment, the same environment causes the tags applied to such items to degrade so that they can no longer be successfully scanned and used for identification. A food seller, handler, or consumer scanning such a tag can rapidly determine  
5 that the food associated with the tag has spoiled due to the apparent degradation of the tag.

As discussed above, certain fabrication methods can be used to prepare dendritic tags that expire on their own. For example, tags that include a mild corrosive material can eventually expire as the corrosive material penetrates its blister pack and dissolves at least a portion of the dendritic structure in the tag. These dendritic tags expire on their own after a certain time period,  
10 which can be selected during fabrication by choosing the amount and concentration of the corrosive material and the nature of the blister pack or other material that encapsulates the corrosive material. Such tags can be applied to food items to serve as a “freshness” indicator, with their expiration periods chosen to correspond to the expected period after which the tagged food items are no longer ideal for consumption.

In some embodiments, a dendritic tag can be applied to a food item by directly incorporating dendritic structures into the Price Look Up (PLU) sticker attached to the food item. FIG. 41 shows a PLU sticker 2600 with a dendritic structure 2610 applied. Methods for growing dendritic structures directly on paper and other porous substrates, as disclosed previously, can be used to incorporate the dendritic structures into PLU stickers. PLU stickers are numbered, and  
20 assigned and administered globally by the International Federation for Produce Standards (IFPS), which maintains a database of PLU sticker information. Records in the PLU database can be augmented by, or linked to, additional information relating to specific food items that bear PLU labels with dendritic structures applied. Thus, while originally intended to speed checkout and provide better inventory control for supermarkets, PLU codes in combination with dendritic tags  
25 can also be used to provide enhanced tracking of individual food items and greater quality accountability at low cost. Further, while PLU codes alone only cover classifications of food items (e.g., conventionally grown apples vs. organically grown apples), combining PLU labels with dendritic tags yields item-specific identifiers that allow individual food items to be identified, checked, and traced back to their point of manufacture or harvesting.

In certain embodiments, dendritic tags can be applied directly to food product labels. The dendritic structures can be fabricated directly on the labels, using the label material (typically

paper) as a substrate in the fabrication process, as discussed above. Alternatively, dendritic tags can be fabricated separately and then applied to food product labels using the methods discussed above. FIG. 41 shows an example of a food label 2600 with a dendritic tag 2610 applied to the label.

5 By appropriate selection of materials, fabricated dendritic tags can even be safe for consumption by humans and animals, so that dendritic tags can be applied directly to food items (e.g., produce, including fruits and vegetables, and various meat products) and consumed when the food items are consumed. As an example, dendritic tags that include dendritic structures formed from silver are consumable; the amount of silver in such a structure is small and non-  
 10 toxic, and may even have beneficial anti-bacterial properties. Once applied to food products, dendritic tags can be scanned using the optical and/or electronic methods described in other sections of this disclosure.

An important advantage of dendritic tags relative to other tracking technologies is radiation hardness. Cobalt-60 is frequently used for gamma-ray irradiation of a variety of food  
 15 and other products for sterilization purposes, including red meat, poultry, spices, cosmetic ingredients, and medical devices. Cobalt-60 sources typically produce high energy gamma photons (e.g., 1.17 MeV and 1.33 MeV) that ionize the irradiated material, liberating electrons that disrupt the molecular structures and DNA of living organisms such as bacteria, causing cell death. Typical dose ranges for various sterilization applications are as follows:

20

Disinfestation treatment of fruits and vegetables for export	0.1-0.5 kGy
Pathogen reduction in meat and poultry	1-3 kGy
Sanitation of spices	5-15 kGy

25 Certain conventional electronic tracking technologies are moderately to severely damaged by ionizing gamma ray radiation at the dose ranges listed above. In particular, many RFID chips are damaged by such radiation. Although certain RFID chips are available that are purposefully fabricated to withstand such doses, these special chips are significantly more expensive than conventional chips. In contrast, the dendritic tags disclosed herein are essentially  
 30 impervious to gamma ray irradiation, as they are not biological in nature and do not contain electronic circuit components. As a result, such tags are highly compatible with food

sterilization processes involving gamma ray irradiation, and can be applied directly to food items and/or packaging before irradiation without suffering degradation during sterilization.

In some embodiments, the dendritic tags disclosed herein are used to counteract tampering and counterfeiting in the pharmaceutical industry, and the ensure quality control.

5 While both of these problems are significant at present, counterfeiting is the most prevalent problem. Counterfeit and/or sub-standard medicines can have severe medical repercussions, including death, particularly since many medicines are administered to vulnerable individuals who have existing health problems. Proposed technologies for tracking individual drugs and packages in the pharmaceutical industry include edible microscopic silica-based barcodes.  
10 However, such barcodes are challenging to manufacture and handle, and require specialized scanning technology.

The dendritic tags disclosed herein can be applied to a wide variety of pharmaceutical products and medical devices and used for identification so that such products and devices can be tracked from their origin, and tampering and counterfeiting can be curtailed. In some  
15 embodiments, as shown in FIG. 42 for example, a label 2700 applied to a drug container can include a dendritic tag 2710 that can be fabricated directly on label 2700, or fabricated separately and applied to label 2700. Such tags can be applied to pharmacy-dispensed packaging, to original packaging at manufacture, to shipping containers, and to a variety of labels applied to the products at intermediate points from the point of manufacture to the point of consumption.  
20 In certain embodiments, consumable dendritic tags, disclosed above for use with food items, can be applied to individual pills, capsules, and vials so that individual units of pharmaceutical products can be identified.

As described above in connection with other applications, the application of dendritic tags to pharmaceutical products (e.g., drugs, cosmetics) and medical devices allows such  
25 products and devices to be tracked throughout their product cycle by shippers, handlers, and consumers to prevent tampering, counterfeiting, and the consumption or use of expired or substandard pharmaceuticals and medical devices. Dendritic tags are applied to such products at the point of manufacture and their information entered into a secure database. Shippers, handlers, and consumers can scan the applied tags and connect to the database to verify the  
30 identity of the tagged pharmaceuticals and medical devices, and to retrieve other stored information about the tagged products.

When the dendritic tags are applied to medical devices such as syringes, pacemakers, stents, valves, and other implants, the hardness of the dendritic tags to Cobalt-60 gamma ray irradiation provides an important advantage, as discussed above. Gamma rays generated by Cobalt-60 sources are used to sterilize many different medical devices. Doses used to sterilize  
 5 medical devices are typically much higher than those used to sterilize food items; some examples are shown below:

Sterilization of pharmaceuticals, cosmetics	5-15 kGy
Sterilization of medical devices	25-35 kGy

10

Because they are non-biological and do not contain electronic components, the dendritic tags disclosed herein remain largely unaffected even by these higher radiation doses. As a result, they are well suited for tracking articles such as medical devices that are subject to sterilization procedures.

15 In addition to applying dendritic tags to a wide variety of products for identification and tracking purposes, dendritic tags can also be integrated into product container seals and/or closures to prevent tampering with the product inside the container. By integrating the tags into the seals and/or closures, tampering with the product by opening or removing the seals/closures damages the dendritic tags. The damage to the tags is revealed when the tags are scanned, and  
 20 the product can be rejected as compromised.

One or more dendritic tags can be used for tamper prevention. FIG. 43 is a schematic cross-sectional diagram showing a product container 2800 with a seal 2810 covering the opening into the container. Two dendritic tags 2820 are positioned at the peripheral edges of seal 2810 where it is attached to the opening of container 2800. Opening container 2800 by mechanical  
 25 removal of a portion of seal 2810 will lead to damaging of tags 2820, which damage is revealed when the tags are scanned. Moreover, because the dendritic structures in the tags have three-dimensional structure as discussed above, producing a duplicate tag by counterfeit methods to mask the tampering would be very difficult.

In some embodiments, by judicious choice of materials, dendritic tags can be fabricated  
 30 that are degraded by one or more of exposure to heat, exposure to light, and exposure to certain chemical substances. As an example, dendritic structures formed of silver can partially dissolve

into an electrolyte film when exposed to light, thereby significantly distorting their structure. Such light-sensitive dendritic tags can be incorporated into packaging materials for products such that scanning of the tags, upon opening of the packaging materials under suitable conditions (e.g., in the absence of light), can reveal whether the packaging has been opened prematurely, as  
5 premature opening will have led to damage to the dendritic structure in the tags. Such light-sensitive tags can also be used as product quality indicators for products that cannot withstand prolonged exposure to light. Damage to light-sensitive dendritic structures in the tags would suggest that the tagged products had been exposed to light at some point.

Heat-sensitive dendritic tags, which are fabricated from materials that deform when  
10 heated above a certain temperature threshold, can be used in a similar fashion. In particular, such tags can be applied to prevent the use of heating methods to tamper with product packaging, as the applied heat will damage the dendritic structures in the tags. Further, for products that are heat-sensitive, the applied tags can reveal when the products have been exposed to potentially damaging temperatures, even if the exposure was accidental in nature and not due to tampering.

15 Dendritic tags that are degraded by exposure to certain chemicals can also be used for both anti-tampering and product quality applications. In some embodiments, for example, dendritic tags that are chemically sensitized to react with a variety of substances, including solvents used to dissolve product packaging adhesives, can be applied to packing materials. The use of such substances damages the dendritic structures within the tags, which is readily  
20 observed upon scanning the tags. Products with tags that are damaged can be flagged as potentially having suffered tampering. For even greater security in some applications, dendritic tags that are sensitive to one or more components of air can be fabricated and applied to the interior of air-tight product containers, which can be evacuated or filled with inert gas prior to shipping. Opening such a container prematurely (i.e., tampering with such a container) will  
25 expose the tags to air, causing a chemical reaction that damages the dendritic structures in the tags. Such damage is readily observed when the tags are scanned.

Moreover, for products that are air sensitive or sensitive to other chemicals, dendritic tags with the same chemical sensitivity can be applied, e.g., on the inside of product packaging. If damage to the tags is revealed by scanning, the product can be flagged as possibly being  
30 damaged due to chemical exposure.

An important application for dendritic tags involves enhancing the security of a variety of identification and security access cards, including driver's licenses, government and/or military identification, employee identification, student identification, building and/or room access cards, computer access cards, passports, birth certificates, software access restrictions, and similar  
5 trusted identification and access cards, documents, and barriers.

Current security access technologies range from simple keys to electronic key cards for physical access, and password schemes and fingerprint scanners for computer access. Conventional mechanical keys are easy to duplicate and are subject to loss and theft. Key cards, although they implement a variety of different technologies (e.g., magnetic stripe encoding,  
10 RFID and/or NFC chips) can also be duplicated or read using a variety of widely available technologies (e.g., magnetic stripe data is easily scanned, and data from RFID and/or NFC chips can be hijacked during transfer using appropriate scanners). Passwords used to access physical locations and computer systems can be stolen via keystroke logging software, and if too simple, can be discovered using a variety of brute force attacks. Moreover, passwords are easily  
15 disseminated among multiple individuals, making access restrictions more difficult to monitor and necessitating frequent password changes which are inconvenient. Fingerprint scanners can be relatively simple to defeat and, as they implement optical scanning technology, may require more frequent maintenance and calibration as components of the system age.

The dendritic tags disclosed herein provide an alternative or a supplement to the various  
20 technologies discussed above for enhancing security in a wide variety of applications. Dendritic tags are easy to read and yet are difficult to duplicate due to their inherent complexity, which is due to natural stochastic electrochemical growth processes. Branching fractal dendritic structures are inherently complex from millimeter to sub-micron length scales and are also three-dimensional in nature. These complex shapes coupled with a tough protective layer over the  
25 relatively fragile structures make them difficult to dismantle and copy economically.

The dendritic structure in each tag defines a "code" through its specific physical structure that is unique to the tag. When stored in encrypted form in a database, the code can uniquely identify the article to which the tag is attached, which allows access restrictions to be implemented. Scanning the tags does not involve the generation of detectable RF signals,  
30 insulating the tags from electronic eavesdropping.

The tags are inexpensive to produce and can be applied at minimal cost to a wide variety of articles. Dendritic tags can be very small (e.g., a few millimeters in diameter), and therefore consist of very little material. Moreover, the tags can be mass produced using roll-to-roll techniques at minimal unit cost. Although dedicated scanners can be used to read the tags, they  
5 can also be readily scanned using conventional smartphones either in unmodified or modified form, making use of the smartphone's inherent communication capabilities to securely access remote databases. Tags that have been damaged or lost can have their records easily purged from databases, making future attempts to use, duplicate, or transfer the tag all but impossible. Further, they can be replaced by newer tags which can be scanned and readily entered into  
10 databases as replacements.

In addition to documents and identification/access cards, wristbands, and other similar key replacements, dendritic tags can be applied to a wide variety of personal items such as watches, wallets, mobile phones, jewelry (e.g., rings, bracelets, pendants), credit cards, and business cards. Due to their small size (e.g., a few millimeters in diameter), they are  
15 unobtrusive, and yet can be readily scanned. Moreover, coating materials used to protect the dendritic structures in the tags render the tags mechanically robust and resistant to damage and environment-induced degradation. If damage to a tag does occur, it can be replaced rapidly and at low cost with another tag.

As discussed above, dendritic tags can be fabricated on a wide variety of substrates,  
20 including various paper and plastic substrates. In particular, dendritic structures adhere well to porous materials such as paper, and can be directly applied to paper documents during printing of the documents. Thus, the methods disclosed herein can be used to fabricate dendritic structures directly on a wide variety of different types of identification cards and documents. Alternatively, or in addition, the fabrication methods disclosed herein for dendritic tags can be used to prepare  
25 tags which can then be applied to cards and documents. Single or multiple dendritic structures can be applied, where multiple structures/tags can provide even greater security in certain circumstances. Further, dendritic tags can be grown directly on, or applied to, other items of identification such as wristbands, key fobs, and labels, and to personal items such as watches, wallets, and jewelry.

30 Cards and documents with dendritic tags are scanned when the bearer passes through an entrance or checkpoint. In addition to the information that is typically read from such cards and

documents (e.g., the bearer's identity, photograph, fingerprints, etc.), the cards and documents are scanned (e.g., using a scanner of the type disclosed herein, which can also be mounted to a doorway frame or integrated into a tabletop scanning unit) and the identity of the cards and documents are checked by verifying information derived from the images of the dendritic structures against database records.

Dendritic tags used for such purposes significantly enhance the security of cards and documents. Because the dendritic structures in the tags are three-dimensional in nature, fabricating accurate copies of the structures is very difficult. As a result, duplication and/or counterfeiting of such cards and documents is much more difficult than for conventional cards and documents, which typically employ anti-counterfeiting technologies such as holograms that are comparatively much easier to fabricate fraudulently.

In addition to cards and documents that relate to the identity of the bearer, dendritic tags can also be used to secure a variety of other documents against tampering and counterfeiting. For example, as discussed above, currency, bearer bonds, cheques, contracts, and other types of commerce-related documents and legal documents can be tagged, so that attempts to alter or copy such documents can be detected by scanning the applied tags.

Access schemes based on identification via dendritic tags can be implemented in a variety of ways. In some embodiments, for example, a user (e.g., a person who has been granted access to a physical location, to a piece of equipment or software) can be issued multiple tags. The issued tags are uncommitted, e.g., they have not been associated in an encrypted and secured database with the user.

To "activate" his access, the user affixes one or more of the tags to an access card or personal object. For example, if the user habitually wears a watch, a dendritic tag can be applied to a portion of the watch that is easy to scan. As another example, the user can apply a dendritic tag to a credit card or other card-based item of identification, or to a dedicated access card, which can implement other security features as well (e.g., photo identification, a password code). Multiple tags can be applied, e.g., to provide access to different physical locations or systems. Alternatively, single tags can be used as universal access keys to all locations and systems to which a user has been granted access.

After application, the tag (or multiple tags) is initially scanned and information associated with the tag is entered into a secure database. The information can include the date on which the

tag was scanned, the location at which the tag was scanned, the article to which the tag was applied, a variety of information about the user (e.g., name, photographic identification, access restrictions and permissions). The information can include an image of the tag. The information can also include one or more features derived from analysis of images of the tag, as will be  
5 discussed in greater detail subsequently. The analysis can be performed by a device operated by the user and information about the features entered into the database. Alternatively, the user can transmit one or more images of the tag to a remote computing device (e.g., the same device that hosts the database), and the remote device can perform the analysis to obtain feature information, and enter the feature information into the database.

10 After the information about the tag is entered into the database and the record associated with the tag is activated, the object to which the tag is attached can be used as an access device (e.g., a key) to gain access to secured locations, secured equipment and/or software, to lock and unlock doors, to arm and disarm security systems, and for a variety of other security-related applications. The tag can be scanned during such applications using a mobile telephone, for  
15 example, or using a dedicated scanner, which can be housed in a physically secure location. Identification of the user bearing the article to which the tag is attached can be performed in one or more steps, for example by using passwords, PINs, pre-selected verification images, single-use time-limited access codes generated securely and transmitted to the user. In some embodiments, these additional identification steps can be performed only once, e.g., upon initial  
20 activation of the dendritic tag. Alternatively, in certain embodiments, the steps can be performed periodically, or even each time the tagged article is scanned. In general, the nature and extent of the additional security measures implemented can be selected upon consideration of factors such as the level of security desired and user convenience.

25 The dendritic tag (or tags) applied to the article is scanned when access to a location or to a piece of equipment or software is required, or another security-related event occurs. Information derived from the scan (e.g., features derived from analysis of one or more images of the tag) is compared to secure database records to identify the bearer of the article with the tag. If a match is found and the bearer's security permissions are appropriate, access is granted (e.g., a "unlock" signal is sent to a door or to equipment, or software access is permitted). Dedicated  
30 scanners can communicate with remote secured databases via wired and/or wireless communication interfaces to transmit information, unlock codes, and other signals. When a

mobile telephone is used to scan the dendritic tag, communication between the phone and a remote device (e.g., a remote server that hosts the database) can occur using wireless network protocols (e.g., via WiFi networks) and/or using mobile telephone networks. In some embodiments, a version of the secured database can be hosted directly on the scanner or mobile telephone; this hosted version can be automatically updated by periodic synchronization with a remote computing device. Communication between the scanner or mobile telephone and the mechanism that secures the location or equipment (e.g., a lock) can occur via encrypted wireless connections on networks such as Bluetooth<sup>®</sup> and/or WiFi networks, for example.

In some embodiments, databases can also store a variety of settings associated with each dendritic tag. Because each tag record is associated with a particular user, various user preferences can be stored within the tag's secured record. Such preferences can include, for example, temperature and/or lighting levels in rooms the user is permitted to gain access, and various software settings within software programs the user can operate. In certain embodiments, the database records can also include tracking information such as the date, time, and location at which the tag is scanned and security access requested. This information can be used to provide detailed reports on the user's attempts to gain access.

If a dendritic tag applied to an article is damaged, lost, or stolen, or if the tag is to be updated (e.g., to provide enhanced security or to grant the user a different set of security permissions), the record associated with the old tag can be purged from the database, a new tag can be applied to the article (or to a different article), and the new tag can be scanned and its information entered into the database. Once the secure record associated with the tag is activated (e.g., following the steps described above), the newly tagged article can be used for secure access in the same manner as before.

## 25 Dendritic Tag Authentication and Identification

Dendritic structures of various types can be used in tags for identification and authentication of articles. For example, general types of dendritic structures that can be used include: radial, in which trunks of the dendritic structure extend from a central growth point; parallel, in which multiple trunks extend approximately in parallel from a common plane or surface; and multiple, in which the dendritic structure includes several radial and/or parallel

structures. FIGS. 32A-C show examples of radial, parallel, and multiple dendritic structures, respectively.

Each of the structures shown in FIGS. 32A-C features multiple trunks, each of which in turn has its own pattern of branches that form a unique fractal pattern in the plane of FIGS. 32A-C. In addition, each dendritic structure is three-dimensional, with fractal structure in the dimension perpendicular to the plane of FIGS. 32A-C. The fractal pattern in the plane of FIGS. 32A-C typically resembles classical dendrites with a tree-like geometry. In the perpendicular dimension, the fractal structure can be dendritic, or may more closely resemble a terrain-like (e.g., mountain-like) form. FIGS. 33A and 33B show scanning electron micrographs of dendritic structures with tree-like and terrain-like fractal structure in the perpendicular direction, respectively.

In general, dendritic structures that are grown in a liquid electrolyte solution which overlies an electrode and supplies ions from above the electrode will have a tree-like fractal structure in the perpendicular direction, extending into the liquid electrolyte. In contrast, dendritic structures that are grown on a solid electrolyte will have a terrain-like fractal structure in the perpendicular direction, as ions are supplied from below the growing structure and build-up the structure from its base. The fractal nature of both tree-like and terrain-like geometries ensures that the general shapes of both types of dendritic structures does not vary with scale, so that the structures appear invariant in both low and high magnification images.

The height of features extending in the perpendicular direction for both tree-like and terrain-like dendritic structures is influenced by growth conditions such as the applied potential difference, the applied current, and the growth time. For terrain-like dendritic structures, the height of features extending in the perpendicular direction can also be influenced via the selection of specific solid electrolyte compositions. For example, using a germanium-rich chalcogenide glass doped with silver for the solid electrolyte yields dendritic structures with features that extend further in the perpendicular direction than using a chalcogen-rich material for the solid electrolyte.

FIGS. 34A and 34B show electron micrographs of dendritic structures grown on different solid electrolytes. The dendritic structure of FIG. 34A was grown on a chalcogen-rich solid electrolyte. The maximum height of features extending in the perpendicular direction in FIG. 34A is approximately 20 nm. The dendritic structure of FIG. 34B was grown on a germanium-

rich solid electrolyte, and the maximum height of features extending in the perpendicular direction is approximately 100 nm. Increased growth in the perpendicular direction is commonly observed in solid electrolytes in which the metal-rich phases are distinct and separate in the solid electrolyte. This tends to occur in chalcogen-poor materials, e.g.,  $\text{Ge}_x\text{Se}_{1-x}$ , where  $x < 0.33$  (e.g.,  
5  $0.33 < x < 0.5$ ).

After a dendritic tag that includes at least one dendritic structure has been applied to an article, the dendritic tag can subsequently be used to identify the article. Identification can be desirable, for example, after the article has exchanged hands, been stored in a storage facility, or otherwise remained un-inspected for a period of time.

10 FIG. 35 is a flow chart 2500 showing a series of steps for identifying an article tagged with a dendritic tag. In the first step 2502, one or more images of the dendritic tag are acquired. The images can be acquired using a variety of image capturing devices including, for example, a dedicated scanning device as shown in FIG. 29, and/or a mobile telephone with or without an imaging module, as shown in FIG. 30.

15 Next, in step 2504, the dendritic tag is authenticated. In the context of this disclosure, authentication refers to the process of verifying that the dendritic tag is an actual dendritic tag and not a copy or replica of a tag. As discussed above, dendritic structures have three-dimensional fractal structure. In contrast, many two-dimensional copies or replicas have only two-dimensional structure. This difference in dimensionality can be used to authenticate tags  
20 featuring dendritic structures.

In particular, to verify that a structure is indeed a dendritic structure, multiple images of the structure can be obtained using low angle illumination from different angles. A dendritic structure – which includes features that extend in the perpendicular direction – reflects light from its different facets in the perpendicular direction. Accordingly, “bright” regions in the multiple  
25 images will change as a function of the angle of illumination.

This technique is demonstrated in FIG. 36, which shows an image of a United States quarter illuminated with ambient fluorescent light and the flash unit of a mobile telephone. The telephone’s image sensor was used to obtain the image in FIG. 36 by imaging with a lens of  
30 module 2408 attached to the telephone. The image shows a portion of the relief of George Washington on the surface of the quarter. The mobile telephone’s flash unit was positioned to

the left of the relief in FIG. 36; as a result, the left-facing relief elements are highlighted by the illumination.

Using similar illumination and image capture techniques for dendritic tags, images of the dendritic structures therein can be obtained from multiple illumination angles. In some  
5 embodiments, color filters can be used to filter the illumination light so that the illumination light is distinguishable from ambient light in images of the dendritic tags. By filtering the illumination light (e.g., light generated from an illumination source such as a flash unit of a mobile telephone), only the edges of the dendritic structure that face the illumination source are illuminated with the filtered light, and therefore appear in a different color than other features in  
10 the image. In addition to, or as an alternative to, obtaining multiple images from different illumination directions, the device used to image the dendritic tag can also record video of the dendritic tag illuminated from different directions, showing a varying pattern of illumination as the illumination direction changes.

Analysis of the images can be performed to determine whether different features of the  
15 structures are highlighted as the illumination direction varies by determining which regions appear brightest in each of the images. In some embodiments, for example, as the reflected light changes with illumination angle, a three-dimensional representation of the outer facets of the dendritic feature can be constructed to convert intensity and position of the reflected light to the angle, height, and position of the reflecting surfaces to verify that the features of the dendritic  
20 structure are indeed three-dimensional in nature, and not two-dimensional. If the angles and heights of the reflecting surfaces all lie within a thin planar region, the likelihood that the structure is a copy rather than a true dendritic structure is increased. The distribution of angles and/or heights can be compared to a threshold value or distribution to determine whether a particular dendritic structure contained in the tag is authentic or not.

25 Alternatively, in some embodiments, the observed changes in reflected light angles and positions as a function of illumination direction are sufficient to establish that a dendritic structure is three-dimensional. The distribution of reflected light angles and/or positions can be compared to a threshold value or distribution for purposes of establishing an authentication of the dendritic structure contained in the tag.

30 In either of the methods disclosed above, image processing is typically performed in the device that captures the images. In some embodiments, however, some or all of the image

processing functions can be performed by a remote computing device (e.g., a remote server) by transmitting some or all of the acquired images at various illumination directions and/or angles to the remote device. Alternatively, or in addition, video of the changing light reflection as a function of illumination angle and/or direction can be transmitted to the remote computing  
5 device and used to authenticate or reject the dendritic tag.

FIG. 44A shows an image of a dendritic structure formed of silver that was grown on a paper substrate. Although the dendritic structure in FIG. 44A appears to be flat in a two-dimensional image, the dendritic structure is actually three-dimensional. As described above, the three-dimensional features of the dendritic structure can be used to authenticate the structure as a  
10 real dendritic structure, and not a two-dimensional copy of such a structure. FIG. 44B shows an image of the dendritic structure of FIG. 44A under perpendicular illumination (i.e., normal to the paper surface) in an optical microscope. An enlarged image of a portion of the structure is shown in FIG. 44C.

FIGS. 45A-D are images showing reflected light from the dendritic structure shown in  
15 FIG. 44B, illuminated with white light from a LED source from the top, left side, right side, and bottom, respectively, relative to the orientation shown in FIG. 44B. In each of FIGS. 45A-D, the circled region corresponds to the growth origin of the dendritic structure, and the rectangles enclose the high points of the dendritic structure, measured in a direction normal to the paper surface.

The images in FIGS. 45A-D were processed using contrast filters and by decreasing the  
20 overall brightness to yield the corresponding images shown in FIGS. 46A-D, which each include a series of small reflected light points or regions. The reflected light patterns shown in FIGS. 46A-D effectively include reflected light from only the highest points in the dendritic structure. Comparing the images, it is evident that different patterns of reflected light are observed,  
25 depending upon the illumination direction. These differing patterns of reflected light from different illumination directions are characteristic of a three-dimensional dendritic structure, and confirm that what is being imaged is a true dendritic structure and not a two-dimensional copy.

The differing patterns of reflected light for specific dendritic structures are shown further  
in the images shown in FIGS. 47A-D. The dendritic structure in FIGS. 47A and 47C was  
30 illuminated with white light from the top direction and from the left hand direction, respectively. and the reflected light images in FIGS. 47B and 47D were obtained, respectively. Each of the

images in FIGS. 47B and 47D were adjusted in contrast and brightness to remove contributions corresponding to scattering from the substrate. The reflected light patterns in FIGS. 47B and 47D differ significantly, which is characteristic of a three-dimensional dendritic structure.

In certain embodiments, reflected light images obtained by illuminating the dendritic structures with different colors of light can provide additional information that can be used to authenticate the structures. For example, when the device used to illuminate the structures includes a tunable laser-based source, reflected light images corresponding to both different illumination directions and different illumination wavelengths can be obtained. Even when illumination occurs from a common direction, when the illumination light is of a different wavelength, reflected light images of certain dendritic structures may appear different, and these differences indicate that what is being imaged is a true three-dimensional dendritic structure, not a two-dimensional copy.

In some embodiments, the three-dimensional nature of the dendritic structure can be further confirmed by comparing the differing patterns of reflected light to database records that include patterns of reflected light, as a function of illumination direction, for authentic dendritic tags. For example, the measured reflected light patterns can be decomposed to identify “sources” of reflected light in each image, each source having a position, a size, and an integrated intensity. Some or all of these attributes of the identified sources can then be compared to similar information derived from database records to determine whether the observed reflected light images match a particular database record, thereby authenticating the tag from which the images were measured. As described above, the database records can also include patterns of reflected light that correspond to illumination with different wavelengths of light, and this information can also be used together with, or as an alternative to, information derived from images corresponding to different illumination directions to authenticate specific dendritic structures.

Using the foregoing methods, a dendritic tag applied to an article can be either authenticated as genuine, or rejected as a likely counterfeit copy or replica. Returning to FIG. 35, if the dendritic tag attached to the article is authenticated, then in step 2506, the image(s) of the dendritic tag are analyzed to extract features of the dendritic structure in the tag. In general, each of the analysis steps disclosed herein can be performed by the device used to acquire the tag

image(s), or by a remote computing device (e.g., a server), after the image(s) has/have been transmitted to the remote device from the image capture device.

As a first step in the analysis, a captured image is typically adjusted to filter extraneous features and produce a line segment representation of the dendritic structure. The adjustment can take a variety of forms. In some embodiments, the image is adjusted by altering the contrast and/or brightness of a grayscale version of the image so that a thinned representation of the dendritic structure is produced. One or more reference patterns printed on the dendritic tag can be used for this purpose. For example, the contrast and/or brightness of the image can be altered so that two adjacent reference patterns on the tag have a particular separation between them. The contrast and/or brightness of all images of the same dendritic tag can then be adjusted so that in each image, the separation between the two reference patterns is the same. Alternatively, or in addition, in some embodiments edge detection algorithms can be used on a captured image to highlight the edges of the dendritic patterns and the thinned (line) version of the image is produced by positioning lines of a single thickness at the mean positions between paired edges. Lines may also be positioned at the mean positions between paired edges, where the thickness of the lines depends on the spacing between the edges. During the production of thinned or line segment images from the original acquired images, curved segments can be replaced with sequences of straight lines to facilitate faster image analysis and digitized image comparison.

Line segments in the thinned image are not necessarily straight, but will typically begin and end on minutiae, which are branching points or terminations that appear in the pattern defined by the dendritic structure. A variety of different dendritic pattern coding schemes for the analysis of the images can be used; a coding scheme is used to identify minutiae by position and type in an image of the dendritic structure. An example of a coding scheme for minutiae types is shown in Table 1.

Designation	Type	Description
C	Center or Origin	Center or Origin of dendritic structure and origin of all trunks (position of growth cathode)
N	N-branch	N <sup>th</sup> branching point, bifurcation, or angular bend after start point in a trunk
T	Termination	End point of any non-continuing line segment
I	Isolation	Isolated point or start (i.e., closest to Center or Origin)

		of isolated line segment or branch
Z	High Z	Element that appears brighter due to larger height in perpendicular direction than average

**Table 1**

In addition to the minutiae types above, fiducials can be printed on a dendritic tag.

5 Fiducials can be used for a number of important functions. In some embodiments, fiducials can be used to indicate directions from which tags can be illuminated to obtain reflected light images of the dendritic structure(s) therein, as described above, to authenticate the tags. The fiducials provide indicators for users who scan the tags as part of a supply chain, for example, to ensure that the images that are obtained correspond to images that were used to generate

10 database information that was stored for the tags, and that is used later to authenticate and/or identify the tags.

In certain embodiments, fiducials are used as points of reference for the analysis of the dendritic pattern. As an example, for radial tags with a central growth point, the Center minutiae point can be the fiducial. Further, S vectors associated with the line segments of the dendritic

15 pattern can be obtained through analysis. An S vector corresponds to a number set that defines the length and angle of a line segment that extends between two minutiae points (M points).

FIGS. 37A-37C show steps in the analysis of an image of a portion of a dendritic structure. In FIG. 37A, the contrast of the image has been adjusted to thin the image, reducing the representation of the dendritic structure to an apparent line pattern. In FIG. 37B, a partial

20 analysis of the thinned image has been performed to identify minutiae points and line segments according to the coding scheme disclosed above. Line segments are overlaid on the image. Identified minutiae points are overlaid on the image as follows: Centers or Origins, open triangles; N branches, solid circles; Terminations, crossed circles; Isolations, open circles; and High Z points, dotted circles.

25 FIG. 37C shows the complete pattern of M points and line segments (S vectors) after analysis of the dendritic structure from FIG. 37A is complete. As shown in this figure, the dendritic structure has been reduced to a collection of features through the analysis, and further operations – such as identification of the dendritic structure – can be based on the set of identified features, rather than on the full image of the dendritic structure.

A variety of different analysis techniques can be used to perform the feature recognition shown in FIG. 37C. In some embodiments, for example, the scale-invariant feature transformation (SIFT) can be used. This technique transforms an image into a collection of vectors, each of which is invariant to translation, scaling, and rotation, and to a certain extent  
5 illumination changes and localized distortion. Scale-invariant feature transformations are disclosed, for example, in Lowe, David G., "Object recognition from local scale-invariant features," Proceedings of the International Conference on Computer Vision 2, pp. 1150–1157 (1999), the entire contents of which are incorporated herein by reference.

SIFT methods are similar to object recognition mechanisms of the primate brain as  
10 described, for example, in T. Serre et al., "A Theory of Object Recognition: Computations and Circuits in the Feedforward Path of the Ventral Stream in Primate Visual Cortex," Computer Science and Artificial Intelligence Laboratory Technical Report, MIT-CSAIL-TR-2005-082, December 19, 2005, the entire contents of which are incorporated herein by reference. Image recognition algorithms of this type can be applied to raw images (e.g., without adjustment to thin  
15 the images) and are typically robust, particularly when training images are used. As such, these methods are well suited for identification of features in images of dendritic structures, which can be distorted by physical damage to the tag that includes the structure, and/or by imperfect imaging conditions.

FIG. 38A shows an image of a dendritic structure that is used to train a SIFT algorithm  
20 for dendritic structure feature recognition. Key training features in FIG. 38A have been identified to the algorithm by tagging with crosses. In FIG. 38B, the trained SIFT algorithm operates on a new version of the training image to identify features in the image corresponding to various types of M points. Specifically, in FIG. 38B, 108 points corresponding to features of the dendritic structure were automatically identified.

25 Returning to FIG. 35, after the set of features corresponding to the dendritic tag has been identified in step 2506, the set of features is compared to records in a database in step 2508 to identify the tag (and the article to which the tag is attached). Typically, this step is performed by a remote computing device to which the dendritic image(s) or extracted set of features have been transmitted. The remote computing device may also host the database, or be configured to  
30 access the database over a secured connection.

If the set of features obtained through analysis in step 2506 is sufficiently accurate, than a unique match to only one database record will occur, uniquely identifying the tag. As discussed above, the database records are typically generated when dendritic tags are applied to articles and scanned, prior to manufacture, shipment, or storage of the tagged articles. Database records are maintained in secure storage to prevent unauthorized access and alteration, and therefore function as an analogue of a fingerprint database for tagged articles.

In general, comparison between the set of features obtained by analysis of images of a particular dendritic tag and database records will yield a number of potential matches. Various methods can be used to determine which of these potential matches is correct, and whether the match is sufficiently precise to properly identify the tag and the article to which it is attached. In the following paragraphs, one example of a method for comparing the set of features obtained from the dendritic images to database records is disclosed, although it should be appreciated that other methods can also be used.

In some embodiments, a hierarchical comparison can be performed between the set of features obtained by image analysis for a dendritic tag and database records to identify the tag. For example, the comparison begins from the center or origin of the dendritic pattern, and then extends in successive steps outward from the center or origin, i.e., from high dimensional features such as trunks and major branches to low dimensional features such as minor branches and twigs. For each successive feature, only database records that also contain such a feature (as well as all of the other higher-dimensional features identified for the tag) are further considered as possible matches. That is, at the beginning of the comparison, all of the database records are considered to be possible matches to the dendritic tag. As each successive feature of the tag is analyzed, the possible list of matching database records can be reduced by eliminating records that do not include the collective list of features analyzed to that point. Thus, analyses of each successive feature typically reduces the number of records that can correspond to a possible match (so that each successive analysis reduces the number of database records that are examined).

For example, a radial dendritic structure may have several trunks originating from the center. The angles between these trunks can be determined and used as the first several “levels” in the hierarchical comparison tree (i.e., only stored records which include this set of angles would be retained for consideration at subsequent levels in the comparison tree). The next

several levels in the tree can be based on features such as the distance from the center of each trunk to the first major branch. Subsequent levels can be based on features such as the angles of these branches to their respective trunks. The foregoing provides examples of features which can be used to implement different levels of the comparison tree, but more generally, any of the  
5 features extracted from the captured images can be used, in any order.

In some embodiments, “box counting” methods can be used to generate a unique identifier for a dendritic structure that can then be compared to information in stored records for purposes of identification. Box counting methods are typically used to determine the fractal dimension of a dendritic structure, and are hierarchical in nature. In this approach, an image of  
10 the dendritic structure is divided into square boxes arranged in a grid pattern. The grid pattern can be aligned to fiducial marks applied to the tag that contains the structure.

Each box is then examined to determine whether or not it contains a portion of the dendritic structure. The output for this examination step is binary: each box is assigned a value of zero if the box includes no portion of the dendritic structure, and a value of 1 if the box  
15 includes a portion of the structure. Typically, in an initial scan, a fine-scale grid is used to digitize the image. Then, in subsequent pattern matching operations, a coarse-scale grid is used initially, and then the analysis is repeated with progressively finer-scale grids, e.g., halving the length of the box for each analysis step, to produce a unique data set to represent the dendritic structure.

20 The analysis corresponding to the coarsest-scale is used to reject all the stored patterns that do not match. Subsequent finer-scale grids are used to do the same, rejecting all non-matching patterns to reduce the time it takes to complete the matching process. Thus, box counting methods implement a hierarchical analysis, just as the feature-based methods discussed above.

25 The rate at which comparisons to stored patterns can be performed can be significantly increased in some embodiments by eliminating regions that correspond to no dendritic structure from further consideration as finer-scale grids are used. The selective elimination of such regions from further consideration is based upon the observation that if a particular region contains no dendritic structure at a coarse scale, then that region (and portions thereof) will also  
30 contain no dendritic structure at finer scales. Accordingly, such regions can be eliminated from

further consideration at successively finer scales, which can significantly reduce analysis time at later levels of the hierarchical analysis scheme.

The comparison between identified features of the tag and database records, or the binary box counting analysis and database records, proceeds until all the non-conforming records are rejected and only one possible match remains. Since the dendritic structures are fractal in nature, this process is primarily limited by the magnification of the image acquisition optics; the higher the magnification used, the greater the number of features (and therefore, levels in the hierarchical comparison tree) as smaller and smaller features toward the ends of each branch can be included in the analysis. In general, the information density from the analysis increases according to the fractal dimension of the dendritic structure.

If the comparison results in no matches between the feature set corresponding to the tag and the database records, in certain embodiments the comparison between the feature set and the database records can be repeated, with relaxed measurement tolerances to obtain a match. In some embodiments, the device used to perform the comparison can prompt the user to re-scan the dendritic tag to obtain a new set of images, which can then be used to repeat the feature set analysis and comparison to database records. The new set of images can also be used to reduce measurement and/or acquisition errors in the original set of tag images, e.g., by combining the images to reduce noise and/or aberrations. As an example, the dendritic nature of the patterns allows defects in the acquired images to be rejected, as the line segments should be continuous and branching so that gaps and isolated truncated points can be ignored during the feature set analysis and subsequent comparison to database records. Captured image blurring can be compensated by the thinning process described above (e.g., by replacing the acquired image with line segments). Scale or magnification distortions can be overcome using Scale Invariant Feature Transform methods, as described above.

If the comparison is repeated and no matches are once again found between the feature set corresponding to the tag and the database records, the device can issue a warning (e.g., a visual and/or auditory message or alert) that the tag could not be properly identified, and may not be genuine.

If the comparison produces more than one possible match between the tag's feature set and the database records, then in some embodiments, the comparison can be repeated with tighter measurement tolerances to produce a more accurate match. In certain embodiments, the

device used to perform the comparison can prompt the user to re-scan the dendritic tag to obtain a new set of images, which can then be used to repeat the feature set analysis and comparison to database records. The new images can also be combined with the previous images to reduce measurement and/or acquisition errors; the combined image information can then be used for the  
5 second comparison.

If multiple potential matches remain following the second comparison (and, possibly, additional subsequent comparisons), further information can be used to distinguish among the potential matches. In some embodiments, for example, contextual information can be used. Dendritic tags can be applied to a wide variety of different articles, and database records can  
10 include information relating not only to the features of the dendritic structures in the tags, but also to the articles to which the tags are applied. This contextual information can be used to distinguish among potential matches.

For example, suppose that two database records correspond to potential matches for a dendritic tag, but the first record includes information indicating that it corresponds to a tag  
15 applied to one type of article such as a pharmaceutical product, while the second record includes information indicating that it corresponds to a tag applied to a different type of article such as a meat product. If the tag that is being identified is attached to a pharmaceutical product, this contextual information can be used to readily identify the first record as a match, and to reject the second record.

In addition, information obtained from reflected light images can also be used to  
20 distinguish among multiple possible database records. As described above, reflected light images that correspond to different illumination directions and/or different illumination wavelengths produce distinctive reflected light patterns from dendritic structures. Information derived from images of these patterns (and/or the images themselves) can be stored in database  
25 records and used to distinguish among records having feature sets that nominally each correspond to the feature set of a dendritic tag that is subject to identification.

In the foregoing discussion, contextual and reflected light information are used to distinguish among possible database record matches after the hierarchical comparison has been performed. More generally, however, this additional information can be incorporated at any  
30 level into the hierarchical comparison to filter out possible matches from among the database records. For example, in some embodiments, this additional information can be used at the first

level, or at one of the first five levels, of the hierarchical comparison. In certain embodiments, using contextual and/or reflected light information early in the hierarchical comparison can significantly reduce the number of database records that are considered at subsequent levels.

Following the comparison in step 2508, the tag is either identified as genuine, or  
5 identification is deemed impossible, and the procedure ends at step 2510. In either case, a message can be delivered to the user of the imaging device (e.g., the dedicated scanner shown in FIG. 29 or a mobile telephone) via a display screen. The user may be given the option of re-scanning the dendritic tag to attempt identification again.

In some embodiments, the set of features associated with analyzed image(s) of the  
10 dendritic tag can be stored in the database and marked as a record corresponding to an unknown and/or potential counterfeit article. Various criteria can be used for determining whether marking of the set of features should occur in the database. For example, the failure to produce any matches in the early levels of the hierarchical comparison is much less likely to be due to measurement/digitization errors and so is more likely to indicate a counterfeit tag, whereas such  
15 a failure in the advanced levels of the comparison could be due to measurement errors. Thus, records can be marked according to the first level at which no match between the tag's feature set and the database records occurs, with a threshold level value (e.g., 2 or 3) to establish whether the record is marked as a likely counterfeit. Records can be marked with a variety of information, including the date and/or location of the most recent comparison to other database  
20 records, the first level at which no match occurred between the tag's feature set and the other records, and the likely or suspected reason for the failure to match any records. By marking the record corresponding to the extracted feature set as corresponding to an unknown and/or potential counterfeit article, subsequent scans of the same tag can rapidly alert the user of the scanning device that the tagged article is suspect.

25 To enhance tracking of potential counterfeit tagged articles, in some embodiments, database records associated with tagged articles can include information about the number of times a tagged article has been successfully identified. For example, for tags that are applied to articles that are expected to be identified only once (i.e., upon receipt of a shipment), multiple identification of the tags may indicate improper, and even fraudulent, re-use of the tags.  
30 Accordingly, database records can include information about the number of times a tag has been successfully identified to assist in tracking such potential improper re-use. In some

embodiments, database records can even be expunged following the first (or more generally, the  $n^{\text{th}}$ ) successful identification, particularly where the records are associated with articles that are expected to be identified only once (or more generally, only  $n$  times). Expunging such records can prevent improper re-use of the tags, as once the records are expunged, it would no longer be possible to identify the tagged articles.

In certain embodiments, database records can also include other information to assist in the identification and tracking of tagged articles. For example, the records can include location information about where identification of specific tags occurred and/or was attempted. This information can be transmitted from the device used to scan the tags (e.g., a dedicated device with a GPS transceiver, or a mobile telephone with an on-board GPS chip). Analysis of the location information can reveal information such as locations where attempts to fraudulently re-use or tamper with tags are particularly prevalent, which can assist in identifying potential problems along a supply chain, for example. Other information that can be stored includes information relating to how many times specific tags were scanned prior to a sale, which can be used to analyze purchaser preferences. If the tags are applied to identification or access cards, the information stored in the tag's database record can include the location and/or time at which the tag was scanned. This information can be used to track access to secured locations, for example.

## Information Coding in Dendritic Structures

A variety of different methods can be used to code and de-code information in/from dendritic structures. In general, these methods take advantage of the complex, stochastic physical morphology of the structures to code information. In other words, the information stored in a dendritic structure is represented by the structure's complex physical features, which are interrogated (for de-coding purposes) at a particular level of granularity or magnification. Multiple physical features can be measured and combined to enable the coding of information in different radices or bases. In general, because the dendritic structures disclosed herein have a high degree of structural complexity and variation, each structure can, in principle, represent one of a very large number of different possible values. This makes the structures ideal for security applications in which the structures represent large key values for, e.g., identification and/or cryptographic purposes.

This portion of the disclosure will first discuss various aspects of fractals and general information coding in fractals, and then discuss methods for encoding and de-coding information in the dendritic structures disclosed herein. It should be appreciated that the methods disclosed can be performed by any of the systems disclosed in the foregoing portions of this application.

5

(a) Fractal Dimension

Dendritic patterns all share the property of self-similarity at different magnifications. Zooming in on a section of the pattern reveals a shape that looks very much like the form of the entire object. In mathematics, this type of pattern is known as a fractal and is characterized by a “fractal dimension”, a number that is related to how the pattern fills the space in which it forms.

10

To understand the term fractal dimension, we first have to consider how to calculate the dimension of an object. FIGS. 48A-C show three different objects, respectively – a line, a square, and a cube – with topological dimensions of 1, 2, and 3 respectively (*i.e.*, a line is 1-dimensional, a square is 2-dimensional, and a cube is 3-dimensional). Each object can be broken into smaller parts, each of which is similar to the original. This is the simplest way to illustrate the concept of self-similarity. For example, the line in FIG. 48A can be broken into 4 smaller lines. Each of these smaller lines is similar to the original line, but they are all  $\frac{1}{4}$  scale. In FIG. 48B, the square can be broken into smaller pieces, each of which is  $\frac{1}{4}$  the size of the original. It takes 16 of the smaller pieces to create the original. In FIG. 48C, the cube can be broken down into smaller cubes of  $\frac{1}{4}$  the size of the original. It takes 64 of these smaller cubes to create the original cube.

15

20

The mathematical pattern which arises from this is:

$$4 = 4^1$$

$$16 = 4^2$$

$$64 = 4^3$$

25

This gives us the equation:

$$N = S^D \quad [1]$$

30

where N is the number of self-similar pieces that go into the full object, S is the scale to which the smaller pieces compare to the full one (*e.g.*, the edge of each small square above is  $\frac{1}{4}$  that of

the large square so  $S = 4$ ), and  $D$  is the dimension (*e.g.*,  $D = 2$  in the case of the square). These results are somewhat obvious for the simple shapes above, but can be generalized for any fractal that includes self-similar elements by calculating the Hausdorff-Besicovitch or fractal dimension by solving for  $D$  in the previous equation:

$$D = \log N / \log S \quad [2]$$

A classic example illustrating the fractal dimension is the Koch Curve. This is a regular fractal structure in which each line is split into three equal parts ( $S = 3$ ) and the middle section becomes an “upside-down V” or chevron with sides the same length as the other fractional segments so that we have four segments ( $N = 4$ ), as shown in FIG. 49A. The fractal dimension  $D$  of this shape is  $\log 4 / \log 3 = 1.26$  which is greater than the topological dimension of a line ( $D = 1$ ).

We can continue making each line segment into such a shape indefinitely to create more complex structures. FIG. 49B shows how the second generation of this fractal is formed. The second generation can be considered in two ways. There are now 16 line segments ( $N = 16$ ) but  $S = 9$  as each segment is  $1/9$  of the original so  $D = \log 16 / \log 9 = 1.26$ , the same as the first generation (as it should be since this is a fractal). The other approach is to consider that the second generation is made up of 4 copies of the first generation at  $1/3$  scale (each with  $D = 1.26$ ). This gives the fractal dimension of the entire structure as  $\log 4 / \log 3 = 1.26$ , the same as before. This is an excellent illustration of self-similarity and that each component has the same fractal dimension as the whole. Note that at higher scale factors, the total (topological) length of the curve increases but it still fits within the length of the original line. If the length of the original line was 1 unit, the first Koch curve will have a total length of  $4 \times 1/3 = 1.33$  units and the second generation will have a length of  $16 \times 1/9 = 42 \times 1/32 = 1.78$  units.

Continuing, the third generation would contain  $64 \times 1/27 = 43 \times 1/33 = 2.37$  units. FIG. 49C shows the Koch curve after many generations and it is clear that the level of detail at this scale factor and the overall length of the curve are both quite large. As expected, this complete structure and all the self-similar elements which make it up also have a fractal dimension of 1.26, even though it is much more complex in appearance than the previous examples.

Generalizing, the length  $L_n$  of the Koch curve is given by

$$L_n = (4/3)^n \quad [3]$$

where  $n$  is the number of generations. For  $n = 10$ ,  $L_n = 17.8$  units but for  $n = 100$ ,  $L_n$  becomes large at over three billion units, even though in all cases the entire pattern fits within a length of 1 unit. Note that if we went to an infinite number of iterations, the fractal dimension would still be 1.26 and but the overall length of the curve would be infinite and it would still fit within a length of one unit. This ability to fit a great deal of fine structure in a very small space is one of the most interesting characteristics of fractals.

A similarly simple structure is the Vicsek fractal which is in some ways closer to the pattern of a dendritic structure in that it contains constantly branching, albeit highly regular, structures. Representations of the 1st, 2nd, and 3rd generations of the Vicsek fractal are shown in FIG. 50.

As is evident from FIG. 50, the “segments” are the squares which make up each cross so that  $N = 5$  at a scale of  $S = 3$ , and  $D = \log 5 / \log 3 = 1.46$ . An interesting characteristic of this structure is that at higher generations,  $n$ , of the fractal, the total area decreases as  $(5/9)^n$  but the perimeter increases as  $4(5/3)^n$  so that in the limit the area is zero but the perimeter is infinite.

#### (b) Information Representation

Each self-similar unit in a fractal can be used to represent information if it is modified in some way, either deliberately or naturally, to allow subsequent determination of its state. This is so, even in the relatively simple Koch curve where binary information can be represented by, for example, the direction (up or down) of the central chevron, as illustrated in FIG. 51.

In FIG. 51, the two elements have the same fractal dimension ( $\log 4 / \log 3$ ) but they are clearly different and therefore are easy to “read” as a 0 or a 1. Similarly, information may be encoded in the Vicsek fractal by the alteration of one or more of the square elements in each cross, *e.g.*, the center square could be white or black with the remaining squares taking the opposite color to represent 0 and 1. Of course, higher order (greater than binary) number representation is also possible by using alterations in more than one element in each similar unit. In the case of the Vicsek fractal, white/black coding can be used in all five squares of each cross; alternatively, a range of color codes can be used in one or more of the five squares of each cross to represent numbers.

The processes which cause the modifications to the elements can be deliberate, *e.g.*, deliberate alteration of one or more units to encode a particular number that is specified ahead of time, or such alterations can be random, *e.g.*, caused by a stochastic process that sets these configurations, and therefore the number associated with them, during the formation of the fractal. The alteration of the structure during formation by “natural” processes is a very important aspect for information security applications, provided such natural processes are capable of creating a vast quantity of unique numbers, each of which can be mapped to a single entity (physical or virtual) in a database.

The number of self-similar units that can be used to represent information will depend on the magnification employed – the higher the magnification, the more self-similar “information units” that can be resolved and read. For every generation of the fractal,  $n$ , the number of information units,  $u_n$ , is given by

$$u_n = \frac{N_1^n}{N_1} = N_1^{n-1} \tag{4}$$

where  $N_1$  is the number of segments in the first generation self-similar element ( $N_1 = 4$  for the Koch curve,  $N_1 = 5$  for the Vicsek fractal).  $N$  is related to the initial scale  $S_1$  by

$$N_1 = S_1^D \tag{5}$$

so that

$$u_n = S_1^{D(n-1)} \tag{6}$$

In terms of scale,  $n$  can be written as  $\log S_n / \log S_1$ , where  $S_n$  is the scale at generation  $n$ , which leads to

$$u_n = S_1^{D((\log S_n / \log S_1)-1)} \tag{7}$$

This can be re-written as

$$\begin{aligned} \log u_n &= \log S_1^{D((\log S_n / \log S_1)-1)} \\ &= D((\log S_n / \log S_1) - 1) \log S_1 \\ &= D(\log S_n / S_1) \end{aligned} \tag{8}$$

Since the magnification  $M$  which allows us to resolve the information units at generation  $n$  is merely the scale ratio  $S_n/S_1$ , we obtain the simple relationship

$$u_n = M^D \quad [9]$$

5 If the information units are examined for binary information, in which two distinct states are read in each unit (as in the example of the Koch curve above), the number of unique integers or “capacity” we can obtain from the  $n$ -th generation of a pattern,  $I_n$ , is

$$I_n = 2^{u_n} \quad [10]$$

10 The effect of this relationship is illustrated in the plots of FIGS. 52A-F. Specifically, FIGS. 52A and 52B are plots of  $u_n$  (information units) and  $2^{u_n}$  (capacity) vs.  $M$  for the Koch fractal ( $D = 1.26$ ), FIGS. 52C and 52D are plots of  $u_n$  and  $2^{u_n}$  vs.  $M$  for the Vicsek fractal ( $D = 1.46$ ), and FIGS. 52E and 52F are plots of  $u_n$  and  $2^{u_n}$  vs.  $M$  for a dendritic structure with  $D = 1.7$  (a typical value for a natural dendritic or tree-like structure).

15 A number of interesting aspects of the use of fractals for information representation may be observed in these plots. Both the number of units and the capacity increase substantially with magnification and they also increase with fractal dimension, the latter outcome being due to an increase in the effective information density of the pattern. The binary capacity can be vast for reasonable values of both  $D$  and  $M$ . For example, in the case of a dendritic structure with  $D =$   
 20 1.7, a magnification of 10x gives a capacity of  $10^{15}$  (compared to around  $3 \times 10^5$  and  $6 \times 10^8$  for the lower fractal dimension Koch and Vicsek structures, respectively); doubling the magnification to 20x results in a resolution that puts the potential capacity for the dendritic structure in excess of  $10^{49}$ . To put this in perspective, if we increased  $M$  to a still modest 27x for the dendritic  
 25 structure, the potential capacity would equal  $10^{81}$  which is thought to be the total number of atoms in the universe.

The capacity of fractal patterns such as dendritic structures to store information becomes vastly larger still if we consider a coding scheme that has more than two identifiable states, *i.e.*, larger than base 2. A scheme in which we can resolve  $B$  individual states would give an information capacity of

$$30 \quad I_n = B^{u_n} \quad [11]$$

The plots in FIGS. 53A and 53B below show the capacity,  $I_n$ , vs. magnification  $M$  (from 1 to 10 in FIG. 53A and from 1 to 25 in FIG. 53B) for a pattern with  $D = 1.7$  and  $B = 2$  (curves 5302 and 5312), 4 (curves 5304 and 5314), 8 (curves 5306 and 5316), and 16 (curves 5308 and 5318). At a magnification of 10, the patterns yield a capacity of approximately  $10^{15}$ ,  $10^{30}$ ,  $10^{45}$ , and  $10^{60}$  integers for  $B = 2, 4, 8,$  and  $16$ , respectively, demonstrating the huge growth in capacity for increasing base. For  $M = 25$ , the potential capacity rises greatly to around  $10^{71}$ ,  $10^{143}$ ,  $10^{214}$ , and  $10^{286}$  states for  $B = 2, 4, 8,$  and  $16$ , respectively.

### 10 (c) Dendritic Fractals

The dendritic structures disclosed herein for use in security applications are fractal in nature but the fundamental difference between these and the Koch and Vicsek examples is that the dendritic structures are formed by processes that have a stochastic character. This means that the fractal dimension is preserved at higher magnification as before, but the precise shape of each self-similar element is unique and random. Accordingly, just like the deliberate coding in the Koch and Vicsek examples discussed above, we can have unique and random information generation and representation without changing the fractal dimension and. The stochastic modification inherent in dendritic structure growth is of particular utility in security applications as the self-assembly that leads to the dendritic form also leads to intrinsic random number generation that can later be used in identification, authentication, and/or encryption.

Since dendritic structures have a degree of irregularity, determination of the fractal dimension is not as simple as in the case of regular structures such as the Koch curve or the Vicsek fractal. An estimate of  $D$  can be obtained, however, by providing a scale  $S$  and then placing the minimum number,  $N$ , of circles of diameter  $1/S$  that are required to cover as much of the pattern as possible.  $D$  is then calculated as  $\log N/\log S$ .

To illustrate this, a first dendritic pattern is shown in FIGS. 54A and 54B, analyzed with two different values of  $S$  ( $S = 2$  in FIG. 54A,  $S = 4$  in FIG. 54B). A second dendritic pattern is shown in FIGS. 54C and 54D, analyzed with the same values of  $S$  ( $S = 2$  in FIG. 54C,  $S = 4$  in FIG. 54D). In FIG. 54A, two circles do not quite cover the entire pattern, but three would encompass too much empty space and so we choose  $N = 2+$  (meaning a little larger than 2) so that  $D$  is just larger than 1, which is clearly inaccurate.

In FIG. 54B, taking  $S = 4$  gives a much more realistic result as we get reasonable coverage with six circles so that  $N = 6+$ , giving  $D = 1.3+$ . Since there is much less of the pattern outside the circles in the  $S = 4$  case, we may conclude that the result for  $D$  is much closer to 1.3 than 1.0.

5 In FIG. 54C, three circles give reasonable coverage and so  $D = 1.6+$ . In FIG. 54D, it takes nine circles to cover the pattern more completely with very little of the pattern left uncovered and so  $D$  appears to be quite close to 1.6. Clearly, higher scale provides a better estimate of  $D$  as any pattern could be covered more completely with smaller circles (or squares, for that matter).

10 This concept is also used in the “box counting” technique discussed above, which is frequently used to give a measure of  $D$  for complex irregular structures. A simplified example of this is given in FIG. 55, in which the more complex dendritic pattern from FIGS. 54C and 54D is covered in square grids with  $S = 4$  and  $S = 16$ . For the more coarse grid ( $S = 4$ ), all the squares contain at least some of the pattern, *i.e.*,  $N = 16$ , leading to  $D = 2$  which is clearly inaccurate. To  
 15 attempt to get a more realistic measure, we only count the large squares that have substantial content (at least 50% penetration by the pattern) and this gives  $N = 9$ . This suggests that  $D$  is somewhere in the range 1.6 to 2. In using the finer grid ( $S = 16$ ), we count a total of  $N = 176$  squares with any content (all colored squares below), although 23 of these have minimal content (yellow squares), leaving a lower boundary for  $N$  at 153 (pink squares). This suggests that  $D$   
 20 actually lies around 1.81 to 1.86.

Thus, for any given number of identifiable states (or coding base)  $B$ , magnification  $M$ , and fractal dimension  $D$  (which can be estimated for a dendritic pattern using box counting or similar techniques), the number of unique integers that can be generated/represented by a fractal structure (or information capacity)  $I_n$  is given as

$$25 \quad I_n = B^{M^D} \quad [12]$$

This double exponential function is interesting due to the large growth rate it represents. Double exponential functions obviously grow much faster than single exponentials but they also grow faster than factorials which makes them of significant interest in fields where very large  
 30 random numbers are generated. In addition to applications which use a large number of unique “tags” for identification and anti-counterfeiting purposes, large random number generation is

used in the field of cryptography, and the dendritic structures disclosed herein can be used to supply unique numbers for keys and ciphers.

In considering the selection of coding base, the ability for the information system to perform unambiguous differentiation of states is important. Binary coding is the simplest but quaternary ( $B = 4$ ) is a reasonable choice in many systems (and one which natural systems such as DNA frequently use). For dendritic structures with  $D = 1.5$  (curves 5602 and 5612), 1.6 (curves 5604 and 5614), 1.7 (curves 5606 and 5616), and 1.8 (curves 5608 and 5618), FIGS. 56A and 56B show plots of capacity vs. magnification for quaternary coding (magnification from 1 to 10 in FIG. 56A, and from 1 to 25 in FIG. 56B).

At a magnification of 10, the dendritic structures yield a capacity of approximately  $10^{19}$ ,  $10^{24}$ ,  $10^{30}$ , and  $10^{38}$  states for  $D = 1.5$ , 1.6, 1.7, and 1.8, respectively. For  $M = 25$ , the potential capacity rises to around  $10^{75}$ ,  $10^{104}$ ,  $10^{143}$ , and  $10^{198}$  states for  $D = 1.5$ , 1.6, 1.7, and 1.8, respectively. The quantities of unique numbers produced at higher magnifications are well beyond the needs of any current or envisioned future item database and are therefore well above the requirements of any tagging system, although they could certainly be of considerable utility in cryptographic systems as discussed above.

#### (d) Information Coding and De-Coding in Dendritic Structures

The complex, constantly branching structures of dendritic fractals readily offer high information capacity through their relatively high fractal dimension ( $D = 1.5$  to 1.7 is typical of natural dendritic structures) and their potential for a high coding base  $B$ . Dendritic structures typically have features that lend themselves to quaternary or higher radix coding (*e.g.*, octal or even hexadecimal). For example, considering the dendritic structure pattern of FIG. 57A, the information unit circled and shown in an expanded view in FIG. 57B has several dimensions that can be utilized to produce readable states that can in turn be used to code numerical values. These include, for example: the length  $L_A$  of segment A from branching point C; the length  $L_B$  of segment B from branching point C, the angle  $\theta_{AC}$  of segment A with respect to the segment that terminates at C; the angle  $\theta_{BC}$  of segment B with respect to the segment at terminates at C; and the distance and bearing ( $R_C$ ,  $\theta_C$ ) of branching point C from a fiducial mark F. The “stick-like” pattern in FIG. 57A, which facilitates geometric measurements, can be generated from the image of a natural dendritic structure via the use of “thinning” functions which replace the

varying widths of trunks, branches, and twigs with uniform lines that correspond to the mid-lines of the original elements, as discussed previously.

In a quaternary coding scheme, readable states such as key dimensions (absolute measurements) or key dimensional relationships (relative measurements) can be used to generate  
 5 the numbers 0, 1, 2, and 3 for each information unit. As an example, for a structure similar to that shown in FIG. 57A, the following relative dimensional relationships can be used to implement a quaternary coding scheme:

- if  $L_A > L_B$  and  $\theta_{AC} > \theta_{BC}$  then the information unit represents a value of 0
- if  $L_A < L_B$  and  $\theta_{AC} > \theta_{BC}$  then the information unit represents a value of 1
- 10 if  $L_A > L_B$  and  $\theta_{AC} < \theta_{BC}$  then the information unit represents a value of 2
- if  $L_A < L_B$  and  $\theta_{AC} < \theta_{BC}$  then the information unit represents a value of 3

For the specific information unit circled in FIG. 57A,  $L_A < L_B$  and  $\theta_{AC} < \theta_{BC}$  so the resulting integer is 3 by the above coding scheme.

15 Using dimensional relationships rather than absolute dimensions may help to reduce the effects of measurement error. Where measurements give ambiguous results, *e.g.*,  $L_A$  appears to be very close to  $L_B$ , a (further) conditional metric can be used. For example, if  $L_A \approx L_B$  then a third (random) variable could be employed as a tie-breaker.

Absolute measurements have the advantage of providing a high radix from a single  
 20 segment, *e.g.*, angle of segment A to the segment that terminates at C ( $\theta_{AC}$ ) alone may generate the numbers 0, 1, 2, and 3 by providing ranges as follows:

- if  $\theta_0 < \theta_{AC} < \theta_{0*}$  then the information unit represents a value of 0
- if  $\theta_1 < \theta_{AC} < \theta_{1*}$  then the information unit represents a value of 1
- if  $\theta_2 < \theta_{AC} < \theta_{2*}$  then the information unit represents a value of 2
- 25 if  $\theta_3 < \theta_{AC} < \theta_{3*}$  then the information unit represents a value of 3

The non-overlapping angular ranges  $\theta_0$  to  $\theta_{0*}$ ,  $\theta_1$  to  $\theta_{1*}$ , etc., are the readable states and are chosen to give equal probability of the result being 0, 1, etc. Proper range selection is based on accurate knowledge of the formation processes for dendritic structures as incorrect ranges  
 30 could possibly introduce a “bias” into the result. For example, if the formation process favored a

particular range of angles then one number would be generated more often than the others which biases random number generation.

To obtain a higher radix coding from a single measurement, more measurement ranges/readable states are used. For example, octal coding would require eight non-overlapping angular ranges, representing the numbers 0 through 7. In principle, the number of distinct ranges that can be used is limited only by measurement errors associated with accurate determination of values of the parameter (e.g.,  $\theta_{AC}$ ) used for coding.

If a similar four range/state methodology was used for another parameter, e.g.,  $\theta_{BC}$ , a separate radix 4 result can be obtained. The two radix 4 measurements can also be combined to implement radix 16 (e.g., hexadecimal) coding without increasing measurement precision beyond four ranges per measured parameter. As an example, the following coding scheme could be used:

- if  $\theta_0 < \theta_{AC} < \theta_{0^*}$  and  $\theta_{0\ddagger} < \theta_{BC} < \theta_{0\ddagger}$  then the information unit represents a value of 0
- if  $\theta_1 < \theta_{AC} < \theta_{1^*}$  and  $\theta_{0\ddagger} < \theta_{BC} < \theta_{0\ddagger}$  then the information unit represents a value of 1
- 15 if  $\theta_2 < \theta_{AC} < \theta_{2^*}$  and  $\theta_{0\ddagger} < \theta_{BC} < \theta_{0\ddagger}$  then the information unit represents a value of 2
- if  $\theta_3 < \theta_{AC} < \theta_{3^*}$  and  $\theta_{0\ddagger} < \theta_{BC} < \theta_{0\ddagger}$  then the information unit represents a value of 3
- if  $\theta_0 < \theta_{AC} < \theta_{0^*}$  and  $\theta_{1\ddagger} < \theta_{BC} < \theta_{1\ddagger}$  then the information unit represents a value of 4
- if  $\theta_1 < \theta_{AC} < \theta_{1^*}$  and  $\theta_{1\ddagger} < \theta_{BC} < \theta_{1\ddagger}$  then the information unit represents a value of 5
- if  $\theta_2 < \theta_{AC} < \theta_{2^*}$  and  $\theta_{1\ddagger} < \theta_{BC} < \theta_{1\ddagger}$  then the information unit represents a value of 6
- 20 if  $\theta_3 < \theta_{AC} < \theta_{3^*}$  and  $\theta_{1\ddagger} < \theta_{BC} < \theta_{1\ddagger}$  then the information unit represents a value of 7
- if  $\theta_0 < \theta_{AC} < \theta_{0^*}$  and  $\theta_{2\ddagger} < \theta_{BC} < \theta_{2\ddagger}$  then the information unit represents a value of 8
- if  $\theta_1 < \theta_{AC} < \theta_{1^*}$  and  $\theta_{2\ddagger} < \theta_{BC} < \theta_{2\ddagger}$  then the information unit represents a value of 9
- if  $\theta_2 < \theta_{AC} < \theta_{2^*}$  and  $\theta_{2\ddagger} < \theta_{BC} < \theta_{2\ddagger}$  then the information unit represents a value of A
- if  $\theta_3 < \theta_{AC} < \theta_{3^*}$  and  $\theta_{2\ddagger} < \theta_{BC} < \theta_{2\ddagger}$  then the information unit represents a value of B
- 25 if  $\theta_0 < \theta_{AC} < \theta_{0^*}$  and  $\theta_{3\ddagger} < \theta_{BC} < \theta_{3\ddagger}$  then the information unit represents a value of C
- if  $\theta_1 < \theta_{AC} < \theta_{1^*}$  and  $\theta_{3\ddagger} < \theta_{BC} < \theta_{3\ddagger}$  then the information unit represents a value of D
- if  $\theta_2 < \theta_{AC} < \theta_{2^*}$  and  $\theta_{3\ddagger} < \theta_{BC} < \theta_{3\ddagger}$  then the information unit represents a value of E
- if  $\theta_3 < \theta_{AC} < \theta_{3^*}$  and  $\theta_{3\ddagger} < \theta_{BC} < \theta_{3\ddagger}$  then the information unit represents a value of F

30 The non-overlapping angular ranges  $\theta_0$  to  $\theta_{0^*}$ ,  $\theta_1$  to  $\theta_{1^*}$ , etc., are the readable states for  $\theta_{AC}$ , and  $\theta_{0\ddagger}$  to  $\theta_{0\ddagger}$ ,  $\theta_{1\ddagger}$  to  $\theta_{1\ddagger}$ , etc. are the readable states for  $\theta_{BC}$ . These are generally chosen to

provide an unbiased result for each parameter. For structures in which a lack of true randomness during formation for any parameter is observed (e.g., due to favored states caused by the formation process), other parameters can be incorporated into the coding scheme.

If length is used as the coding measurement, four length ranges for  $L_A$  would yield a  
 5 radix 4 result but combining four length ranges for both  $L_A$  and  $L_B$  (as for  $\theta_{AC}$  and  $\theta_{BC}$  above) would again yield a radix 16 (numbers 0 through F) coding scheme. Generalizing, the radix or coding base B can be represented by

$$B = R^P \tag{13}$$

10 where R is the number of readable states chosen, and P is the number of parameters measured, assuming that each parameter has the same number of readable states. For  $R = 4$  and  $P = 1$  (a single parameter measured),  $B = 4$ , giving us quaternary coding. Two parameters gives  $B = 16$  (hexadecimal), three gives  $B = 64$ , four gives  $B = 256$ , etc. Combining this with the expression for information capacity gives

$$15 \quad I_n = (R^P)^{M^D} \tag{14}$$

This triple exponential function has an extraordinarily high growth rate. For the earlier simple Koch curve example at 3x magnification,  $R = 2$  (an “up” or “down” chevron in each structure),  $P = 1$  (measurement of one parameter – the position of the chevron),  $M = 3$  (showing  
 20 four self-similar structures), and  $D = \log 4/\log 3$ , so that  $R^P = 2$ ,  $M^D = 4$ , so the capacity is a mere 16 integers. For a dendritic structure with a fractal dimension of 1.7, measuring two variables with four readable states at 10x magnification, (i.e.,  $R = 4$ ,  $P = 2$ ,  $M = 10$ , and  $D = 1.7$ ),  $R^P = 16$ ,  $M^D = 50.12$ , and  $I_n = 2.2 \times 10^{60}$ . Another illustration of the growth of the function is given in  
 25 Table 2 below, in which the three fractals discussed above are compared at a magnification of 10. In Table 2, two simple Vicsek coding schemes are included: Vicsek<sub>1</sub> in which the center square in each cross is either black or white; and Vicsek<sub>5</sub> which allows any single square in each cross to be black with the rest being white, leading to 5 readable states in 1 parameter.

Fractal	R	P	M	D	$I_n$
Koch	2	1	10	1.26	$3 \times 10^5$

Vicsek <sub>1</sub>	2	1	10	1.46	4.8 x 10 <sup>8</sup>
Vicsek <sub>5</sub>	5	1	10	1.46	1.4 x 10 <sup>20</sup>
Dendrite	4	2	10	1.7	2.2 x 10 <sup>60</sup>

**Table 2**

To show the effect of the number of parameters measured, FIG. 58 is a plot of information capacity  $I_n$  vs. parameters P for a dendritic structure with  $D = 1.7$  and  $R = 4$  at  $M = 10$ . Additional parameters P can arise from more complex patterns in each information unit (e.g., more branches and consequently higher fractal dimension) or from the use of measurements that are external to the information unit such as range and bearing from a fiducial mark as shown in FIG. 57A.

Where the readable states are not the same for each measured parameter in an information unit, the equation for the coding base B can be generalized as

$$B = R_1 \times R_2 \times R_3 \times \dots \times R_p = \prod_{i=1}^p R_i \tag{15}$$

where  $R_i$  is the number of readable states for parameter i. This leads to a more general expression for information capacity:

$$I_n = \left( \prod_{i=1}^p R_i \right)^{M^D} \tag{16}$$

Equation (16) assumes that the information base is the same for each information unit, a reasonable assumption since these are self-similar and therefore contain elements that will yield similar readable states and parameters. Table 3 below gives an example of five coding schemes with P ranging from 1 to 4 and R values of 2 and 4,  $I_n$  being calculated for  $M = 10$  and  $D = 1.7$ . Again, it is obvious from these sample results that increasing P and R cause a very large increase in capacity.

Scheme	R <sub>1</sub>	R <sub>2</sub>	R <sub>3</sub>	R <sub>4</sub>	P	M	D	$I_n$
a	2	-	-	-	1	10	1.7	1.2 x 10 <sup>15</sup>
b	2	2	-	-	2	10	1.7	1.5 x 10 <sup>30</sup>

c	2	2	4	-	3	10	1.7	$2.2 \times 10^{60}$
d	2	2	4	4	4	10	1.7	$3.3 \times 10^{90}$
e	4	4	4	4	4	10	1.7	$5.0 \times 10^{120}$

**Table 3**

Referring again to Equation (14), the information capacity  $I_n$  for a particular coding  
 5 scheme can be expressed as a triple exponential function in terms of the number of readable  
 states  $R$ , the number of parameters  $P$ , the magnification  $M$  at which images of the dendritic  
 structures are obtained, and the fractal dimension  $D$ , where the number of readable states is  
 assumed to be the same for each parameter. In some embodiments, values for each of  $R$ ,  $P$ ,  $M$ ,  
 and  $D$  can be chosen so that particular dendritic structures are analyzed at a particular  
 10 information density level. That is, values for each of  $R$ ,  $P$ ,  $M$ , and  $D$  are determined (i.e., either  
 automatically by system software or via user-selected or –entered preferences) prior to analyzing  
 the dendritic structures to control the number of unique integers that each pattern is assumed to  
 be capable of representing.

For example, for certain applications involving relatively low security levels (e.g.,  
 15 “minimum security” applications) or in a “first pass” of a multi-level security screening  
 procedure, values for each of  $R$ ,  $P$ ,  $M$ , and  $D$  can be chosen to yield a relatively low information  
 density level. Thus, each dendritic structure analyzed is assumed to represent only one of a  
 relatively small set of possible integers. In these applications, scanning and analysis of the  
 dendritic structure is frequently performed at high-speed for purposes of rapidly and generally  
 20 assessing the information represented by the structure. As an example, a “low security” or  
 “rapid scanning” first analysis can be performed to determine information such as which one of  
 several categories the dendritic structure represents, or whether the dendritic structure  
 corresponds to a binary “pass” or “fail” classification. In applications where the number of  
 possible classifications, states, or outcomes is relatively limited, a relatively low information  
 25 density can be advantageous, as it enables more rapid screening (due to the less detailed analysis  
 involved), and can also allow for improved error tolerance, as the integer represented by the  
 dendritic structure is typically not as sensitive to small variations in the morphology of the  
 structure.

For applications involving higher security levels (e.g., “medium security” or “maximum security” applications) or in later passes of multi-level screening procedures, values for each of  $R$ ,  $P$ ,  $M$ , and  $D$  can be chosen to yield a relatively higher information density levels. Although analysis of dendritic structures is typically slower at higher information density levels, the  
5 reduced speed is generally warranted by the increased security requirements. As an example, a higher information density can be used in forensic applications, or in a second screening step of a multi-level screening procedure where dendritic structures which have first been pre-classified in an initial screening step (e.g., at lower information density) are then analyzed at a higher information density level to elucidate finer differences between the structures, thereby further  
10 classifying the structures.

As explained above, values for each of  $R$ ,  $P$ ,  $M$ , and  $D$  can be chosen to yield a selected information density level (i.e., the number of possible states represented by dendritic structures that are analyzed) either by user-selected or –entered preferences, or, in some embodiments, automatically using stored system settings. In certain embodiments, the systems disclosed herein  
15 can be configured to retrieve stored values of  $R$ ,  $P$ ,  $M$ , and  $D$  based on information about the particular application involved. For example, a user of the system can enter application information or select from a list of available applications on a user interface. With this information, the system can then determine appropriate values of  $R$ ,  $P$ ,  $M$ , and  $D$  to set the information density. In the system’s storage unit, appropriate values of  $R$ ,  $P$ ,  $M$ , and  $D$  can be  
20 stored in records associated with particular applications. Alternatively, or in addition, the system can first determine an appropriate security level associated with a particular application, and then retrieve stored values of  $R$ ,  $P$ ,  $M$ , and  $D$  that are commensurate with the security level. For applications involving multiple security levels (such as multi-level scanning procedures), the system can adjust the values of  $R$ ,  $P$ ,  $M$ , and  $D$  (e.g., by retrieving new sets of these parameters  
25 for each successive step in the procedure) during the scanning and analysis operation.

The measurement of geometric features to produce unique parametric sets can be achieved via software operating on a captured image of the pattern. In some embodiments, a more “Cartesian” approach can be applied to the generation and reading of information which can lead to faster and more efficient computation, as the input to the computer will most likely be  
30 from a digital camera which uses a sensor that captures images in the form of an X-Y array of

values. If this arrayed data can be analyzed more directly, it potentially saves software conversion and analysis steps, reducing overall processing time.

Cartesian coding shares some features in common with box counting methods in that a grid is applied over the pattern and the boxes which contain any part of the pattern are counted, as shown for a simple dendritic structure in FIG. 59. For the structure in FIG. 59, it takes 24 boxes at 1/8th scale to encompass the solid lines in the pattern and so we can estimate the fractal dimension as  $\log 24 / \log 8 = 1.53$ .

To code the pattern of solid lines using the grid, the positions of the occupied boxes on the grid space are recorded. If the lower left green box is (1,1) in this example, the dendritic structure occupies the following set of coordinates (ordered by row):

(4,1),  
 (1,2), (4,2),  
 (1,3), (2,3), (3,3), (4,3), (5,3),  
 (2,4), (3,4), (4,4),  
 (2,5), (4,5), (5,5), (6,5), (7,5),  
 (4,6), (5,6), (6,6),  
 (4,7), (6,7), (7,7), (8,7),  
 (6,8)

This set of 24 coordinates forms the basis for the generation of the integer associated with the pattern. In a digital computation scheme, the coordinates can correspond to the addresses of the data in the computer memory. If the pattern is even slightly different, *e.g.*, the gray solid line in (4,1) takes up the dashed line position and extends into blue box (5,2) instead, the set of coordinates changes to:

(1,2), (4,2), (5,2),  
 (1,3), (2,3), (3,3), (4,3), (5,3),  
 (2,4), (3,4), (4,4),  
 (2,5), (4,5), (5,5), (6,5), (7,5),  
 (4,6), (5,6), (6,6),  
 (4,7), (6,7), (7,7), (8,7),  
 (6,8)

A different integer is generated from this set of coordinates.

If the scale of the box grid is given by  $S_G$  (and the total number of grid squares/locations in a square array is  $S_G^2$ ), then the total number of coordinates in the set  $C$  is simply

$$5 \quad C = S_G^D \quad [17]$$

and the ratio of the number of pattern squares to grid locations  $G$  is

$$S_G^D / G = S_G^D / S_G^2 = S_G^{D-2} \quad [18]$$

10 A finer grid captures more detail in the pattern and therefore generates higher information content. This results in a larger coordinate set but the ratio of the number of pattern coordinates to the total number of grid locations decreases greatly as the latter increases, as shown in FIG. 60. As demonstrated with the Vicsek fractal discussed above, this reduction in fractional area with increasing scale is an important characteristic of fractals.

15 A practical limit of this grid coding technique may be the physical resolution of the camera sensor that is used to capture the image of the pattern, *i.e.*, how many pixels the imaging element has. Even relatively inexpensive digital cameras, such as those found in cell phones, have sensors with multi-megapixel capability so a grid of several thousand by several thousand boxes is possible. For  $G = 3000 \times 3000 = 9$  million pixel square array covering a pattern that has  
 20  $D = 1.7$ , the number of coordinates that will describe the pattern  $C = 3000^{1.7} = 8.15 \times 10^5$ . Different patterns will, of course, have different individual coordinates but the number of coordinates in the set will be about equal for patterns with the same fractal dimension.

When the resolution is large, the number of coordinates that uniquely represents the pattern can be considerable but it is the possible variations of these coordinates that creates a  
 25 very large number of possible sets which in turn can be used to generate unique integers. Consider the simple case with a non-branching structure in which each coordinate could take on 2 possible values at each point in the pattern, *i.e.*,  $(x_g^+, y_g^+)$  or  $(x_g^-, y_g^-)$  at location  $g$  where  $1 < g < C$ , as shown in FIG. 61. This binary single branch structure yields  $2^C$  possible outcomes. For the case of a pattern which has 24 coordinates, if each of these can take on two values, there are  $2^{24}$   
 30 possible outcomes, close to 17 million variations in the coordinate set. Considering the nine

megapixel example in which  $C = 8.15 \times 10^5$ , there could be over  $10^{245,000}$  possible variations. This is obviously a huge number but is considerably smaller than the possible number of variations if every location the 3000 x 3000 grid could take on a binary value, *i.e.*,  $C = 9 \times 10^6$  which gives  $10^{2,710,000}$  possible variations.

5           The binary non-branching/single branch constraint is, of course, highly conservative as each of the coordinates in the set can realistically take on more than two values, depending upon whether the pattern has continued, branched, or terminated at any location in the grid. The first two options also have additional possibilities associated with them, as shown in FIG. 62.

          This suggests that a k-ary (rather than binary) structure should be considered, where k  
10       could reasonably be 6. In a k-ary structure, we have  $k^C$  possible variations so that the nine megapixel example would yield an astonishing  $6^{815,000}$  or more than  $10^{634,000}$  possible values.

          Various criteria can be used to determine whether a particular box in a grid structure is occupied by a portion of a dendritic structure. In some embodiments, the box is occupied if even one pixel corresponding to the box overlaps with a portion of the dendritic structure. In certain  
15       embodiments, the box is occupied only if the box's fill factor (e.g., the ratio of the number of box pixels that overlap with a portion of the dendritic structure to the total number of box pixels) exceeds a threshold value. For example, the threshold value can be 50% or more (e.g., 60% or more, 70% or more, 80% or more).

          In general, for the Cartesian encoding approach, the information density  $I_n$  is a function  
20       of the number of structural options  $k$ , the total number of grid locations or boxes  $G$ , and the fractal dimension  $D$ , according to:

$$I_n = k^{G^D} \quad [19]$$

          In some embodiments, values for each of  $G$  and  $D$  can be chosen so that particular dendritic  
25       structures are analyzed at a particular information density level. That is, values for each of  $G$  and  $D$  are determined (*i.e.*, either automatically by system software or via user-selected or – entered preferences) prior to analyzing the dendritic structures to control the number of unique integers that each pattern is assumed to be capable of representing.

          For example, as discussed above, in low security applications (or in the initial step of a  
30       multi-step screening procedure), dendritic structures can be analyzed at a relatively low information density by selecting suitable values for  $G$  and  $D$  such that the dendritic structures

analyzed are assumed to represent one of only a relatively small number of integers. Scanning and analyzing dendritic structures at low information densities can be advantageous because it can generally be performed more rapidly than analyses at higher information densities, and may also permit higher error tolerances as the integer represented by a given dendritic structure can  
 5 be less strongly dependent on small structural variations.

In higher security applications, or in later stages of a multi-step scanning procedure, dendritic structures can be analyzed at higher information densities by suitably choosing different values of  $G$  and  $D$ . To implement multi-step analysis procedures, the values of  $D$  and  $G$  can be adjusted between steps as discussed above.

10 The previous analysis was based on a Cartesian approach but we could also use a “polar” method in which the pattern is divided by a series of concentric circles as shown in FIG. 63. There are several ways that this can be used to extract information from the pattern. In some embodiments, sectors are formed over the pattern by placing lines that radiate from the center with angles between them of  $360^\circ/F$ , where  $F$  is the desired number of sectors per ring. The  
 15 sectors which contain part of the pattern are then logged as in the Cartesian approach above but this time with radius and angle ( $r, \varphi$ ) defining each sector. The main difference between Cartesian and polar methods is that the boxes are typically all the same size in the former whereas the sector area  $A_s$  in the polar case will be determined by the difference in the squares of each successive radius.

20 If the radii follow a simple progression such as  $hr_0$ , where  $r_0$  is the radius of the smallest circle and  $h = 1, 2, 3$ , etc. up to the number of the last circle, then the increase in sector area  $\Delta A_s$  from one radius to the next is given as

$$\Delta A_s = \pi r_0^2 \cdot 2(h-1) / F \quad [20]$$

25 The resolution will therefore decrease from the center to the edge of the pattern unless the larger sectors are further divided to sub-sectors that keep the area of each cell equal throughout the polar grid. Since the smallest cell area  $A_0 = \pi r_0^2 / F$ , the grid can be standardized to this by using the fact that the area of each sector at radius  $hr_0$  is

$$A_{s,h} = \pi r_0^2 (2h-1) / F \quad [21]$$

30 so that the ratio of this sector area to the standard (minimum) area is

$$A_{S,h} / A_0 = 2h - 1 \quad [22]$$

This means that each sector created by the choice of F must be split into 2h-1 sub-sectors, each having area A<sub>0</sub>. For example, in the ring between the first and second circles (h = 2), the main sectors must be divided into 3 sub-segments; sectors in the h = 3 ring will be divided into 5 sub-sectors, the h = 4 ring sectors will have 7 sub-sectors, and so on. The placement of the sub-sectors is naturally dictated by the positions of the lines which define the sectors so that the sub-sector “grids” may be standardized; if the sub-sectors were not aligned to the sectors, the polar grid could be different each time, with different alignments of the sub-sectors in each ring. In terms of angles, for the example of F = 120 leading to sectors of angular width 3°, the sub-sectors in h = 2 the ring would have and angular spacing of 3°/3 = 1°, the h = 3 ring’s sub-sectors would be spaced by 3°/5 = 0.6°, and so on. Generalizing, the angular spacing/resolution of a sub-sector in ring h is given as

$$\Phi_{ss} = 360^\circ / (2h - 1)F \quad [23]$$

The total number of sub-sectors (or addresses), G, available in a polar grid with E circles/discrete radii and F sectors is

$$G = \sum_{h=1}^E (2h - 1)F = E^2 F \quad [24]$$

For example, if we have E = 300 (circles) and F = 100 (sectors), we will have 9 million “pixels” as in the Cartesian example above. The polar grid is more complex than the Cartesian “box” method but does have certain potential advantages. For example, in the case of a radial dendritic structure (one that has been grown from a central point), a polar grid better fits the shape of the pattern.

An alternative polar approach is to overlay concentric circles as before and then record the points where the dendritic structure and the circles intersect. These points are characterized by simple vectors containing their distance r from a fiducial mark (e.g., the center point of the dendritic structure) and angle φ from a baseline, as shown in FIG. 64 (the baseline corresponds to the dotted line in the figure). The resolution of this scheme depends on the spacing of the circles (smaller spacing means more circles which in turn means more intersections) and as long

as their radii are discrete, the vectors produced will also be discrete “samples” of the entire pattern. This technique simplifies the measurements and reduces the amount of data to be handled in the reading scheme.

5 (e) Dendritic Structure Verification

In both the geometric and Cartesian approaches discussed above, the systems disclosed herein can be configured to verify the integrity of the information (e.g., the integer value) represented by a particular dendritic structure by determining the structure’s fractal dimension  $D$  under different conditions. For a given dendritic structure, the fractal dimension  $D$  should be  
10 constant, independent of the magnification  $M$  at which the image of the dendritic structure is obtained, independent of the number of pixels in the image (or number of grid points  $G$ ) used for analysis, and independent of the location within the dendritic structure at which  $D$  is determined. By determining  $D$  for a given structure at different magnifications and/or in images with different numbers of pixels or grid points for analysis and/or at different locations within the  
15 structure, and comparing the values of  $D$  obtained under these various conditions, the integrity of the information represented by the dendritic structure can be verified (e.g., if the values of  $D$  agree to within a specified tolerance value). If the values of  $D$  do not agree, then corruption of the dendritic structure has likely occurred.

All dendritic structures grown under similar conditions should also have the same fractal  
20 dimension  $D$ . Thus, for a given dendritic structure, values of  $D$  determined at different magnifications, at different locations, and/or using different numbers of image pixels or grid points, can be compared by the systems disclosed herein to reference information for the type of dendritic structure being analyzed to determine whether  $D$  is within an acceptable range of values. Even if multiple values of  $D$  determined for a particular dendritic structure agree with  
25 one another, they may still fall outside an acceptable range of values for the particular type of dendritic structure being analyzed, indicating that the structure has likely been compromised or does not correspond to a dendritic structure of the expected type. In some embodiments, individual  $D$  values for a particular structure can each be compared to a reference range to assess structure corruption. In certain embodiments, particularly where multiple  $D$  values are  
30 determined and agree for a particular structure, the multiple  $D$  values can be averaged and compared to reference range information.

As an additional verification of the integrity of the information represented by a particular dendritic structures, the systems disclosed herein can be configured to use adjacency algorithms to determine how much of the spatial region surrounding any particular point in the pattern represented by the dendritic structure should contain additional portions of the pattern.

5 For example, the systems can be configured to predict, based on the analyzed portions of the dendritic structure, the anticipated pattern represented by other (e.g., adjacent) portions of the structure. The additional portions of the actual structure are then compared to the predicted pattern to determine the extent of the match. If selected system tolerances are violated (e.g., too few adjacent locations or too many adjacent locations contain an extension of the pattern

10 represented by the actual dendritic structure, based on the expected pattern), then it is likely that dendritic structure has been corrupted, and the information it represents as well.

(f) Error Correction

In general, any pattern containing multiple units with several identifiable states per unit

15 could be used to generate and represent numbers. For instance, an array of pixels in which each element can be randomly black (e.g., 0) or white (e.g., 1) can be used to generate numbers; a mere 1000 of such binary pixels would yield  $2^{1000}$  or about  $10^{301}$  possible integers. A nine megapixel binary array could potentially give yield  $10^{2,710,000}$  values.

However, there are issues beyond capacity that are relevant to the choice of coding

20 scheme, chief among them the unambiguous determination of the numbers that the patterns represent at various points in time and space. What makes fractal patterns of particular interest for information representation is that their structure is predictable at all magnifications; we know that all information units must have the same fractal dimension and the same general shape, even if they are different in some way. This predictability of form is important for robust information

25 representation as noise in the form of pattern distortions, surface imperfections, material defects, reading errors, etc. can easily corrupt pattern information.

In the pixel array example at in the previous paragraph, it would be impossible to know if an element had an incorrect coding via a random error as there is no structure to the pattern - random errors in a random pattern are in essence invisible. This is why existing matrix barcode

30 schemes, essentially 2-dimensional arrays of pixels, such as the Quick Response or QR code,

have substantial error correction coding or ECC built in (typically a sophisticated Reed-Solomon correction) and this significantly reduces the information capacity of the pattern.

Fractals do not require extensive extrinsic error correction due to their intrinsic predictability which allows us to determine if they have been corrupted and can even help to correct the problem. In other words, if the form of the shape is known, it is much easier to fill in missing portions or remove extraneous objects.

FIG. 65A is a schematic diagram of a pristine dendritic structure. FIG. 65B is a schematic diagram of the same structure as in FIG. 65A, with certain “damage features” added that lead to measurement noise and/or errors. In FIG. 65C, the damage features have been identified and labeled 1-4. Because these features have altered the shape and/or density of the pattern at a local level, the fractal dimension in these regions will have changed and this is the first indication of the presence of noise.

Considering each error in turn and possible strategies for correction, feature 1 is a gap in two branches which should be continuous. This is apparent due to the alignment of the disembodied sections and the change in the fractal dimension (or increase in the local lacunarity) of the feature. A “digital repair” is relatively straightforward in this case by interpolating the missing sections via software and regenerating the number associated with the pattern.

Noise features 2 to 4 are additional lines within the pattern but 2 is not an extension of the existing structure and therefore can be ignored. Feature 3 links two branches which is not allowed in a planar dendritic pattern and so this should be erased. Feature 4 results in a retrograde (backward growing) branch section which also may be flagged as unusual. This last feature illustrates that directionality can be useful in the elimination of spurious features, as a simple or complex pattern that is “going against the grain” of the dendritic structure can be considered to be an error and ignored in the analysis.

Accordingly, with knowledge of how the dendritic pattern should appear generally, it can be relatively straightforward to identify and correct gross errors. More subtle errors, such as point defects in the pattern or in the spaces between the features, can be corrected using averaging techniques, *e.g.*, if most of the pattern surrounding a “white” point is “black”, then the point should also be black and vice-versa.

In the Cartesian or polar coding approaches, the fractal dimension can be determined and monitored via a box-counting (or related) method to ensure integrity for the entire pattern or in

specific regions. The identification of specific errors can be achieved by the use of adjacency algorithms which deal with the data at the pixel level. In such methods, for any pixel that includes the pattern there will exist a number of “allowed” adjacent pixels which arise from the pattern’s fractal dimension and the “growth rules” of dendritic structures. If we consider a 3 x 3 pixel square with a piece of the pattern (or a portion of the thinned pattern) in the central pixel, the number of pixels which are allowed to also contain part of the pattern,  $a_p$ , is

$$a_p = \lfloor S^D - 1 \rfloor \quad [25]$$

where [...] indicates the floor of the function within the brackets (*i.e.*, the result,  $a_p$ , is given in whole pixels). Since the edge of the region in the example above has 3 pixels, the scale factor  $S$  equals 3, so that the number of allowed pixels,  $a_p$ , in the 8 pixels adjacent to the central one for a  $D = 1.5$  pattern is 4, and for a  $D = 1.7$  pattern is 5. Similarly, expanding the surrounding neighborhood to a 5 x 5 pixel square (24 neighboring pixels in all) so that  $S = 5$ , a  $D = 1.5$  pattern has  $a_p = 10$  pixels and a  $D = 1.7$  pattern has  $a_p = 14$  pixels. Information about the number of allowed pixels can be combined with the dendritic growth rules discussed earlier, which forbid gaps, disembodied features, elements which link separate branches, and significant retrograde pattern evolution, to provide a final determination of pattern/image validity.

Another significant source of error is pattern alteration caused by the image capture process itself. If a camera is used, image translation/rotation, geometric distortion, imperfect focus, etc., can change the appearance of the image and this can be accounted for in the analysis. Whereas there are a number of software-based techniques that may be used to analyze/recognize distorted patterns, such as scale-invariant feature transform (SIFT) methodologies, simpler approaches are almost certainly more appropriate in the case of manufactured patterns and relatively controlled reading environments.

In some embodiments, fiducial marks with known geometric properties can be used, which allow the simple and rapid determination of pattern position and orientation, focus/blur, contrast, and other optical distortions such as keystone effects caused by the pattern/substrate being not parallel to the focal plane of the optical system. These marks can be printed on the substrate that contains the information pattern, captured with the same reading system, and the analysis used to correct distortions in the pattern.

An example of the use of a fiducial marking system is shown in FIGS. 66A-D. Three cross-like fiducial marks have been added to a substrate that carries a dendritic pattern, as shown in FIG. 66A. The marks have dimensions and relative positioning that are known to the system. By analyzing the positions and dimensions of the fiducial marks in the image of the dendritic structure, the system can determine when the entire image has been rotated (FIG. 66B),  
 5 defocused (FIG. 66C), and/or exhibits keystone distortion (FIG. 66D).

In some embodiments, dendritic pattern errors caused by imperfect manufacturing or severe use environments can be mitigated via the use of redundancies. As discussed previously, the capacity of a dendritic fractal pattern can be expressed as

$$10 \quad I_n = \left( \prod_{i=1}^P R_i \right)^{M^D} = \left( \prod_{i=1}^P R_i \right)^{u_n} \quad [26]$$

The double exponent  $M^D$  gives the total number of resolvable information units in the pattern but it is also possible for us to use a subset of units,  $u_n'$ , to generate our unique integers so that the capacity becomes

$$15 \quad I_n = \left( \prod_{i=1}^P R_i \right)^{u_n'} \quad [27]$$

As long as a high capacity is maintained, not using all units in the patterns can be a good strategy as it allows certain units to be ignored, *e.g.*, those which may have manufacturing defects or are otherwise of poor quality, in the original (newly-formed) pattern. A number of  
 20 units can also be reserved for other purposes, *e.g.*, to generate a secondary code that is not related to the integer created from the rest of the pattern. For example, in the case of  $M^D = 50$ , 10% of the units can be reserved for redundancy, so that  $u_n' = 45$ . Even in a simple reading scheme where  $R = 2$  and  $P = 2$ , this still allows for the coding of over  $10^{27}$  integers.

## 25 Polarized Scanning of Dendritic Identifiers

As discussed above, multi-scale structural complexity in dendritic structures makes such structures difficult to replicate, ensuring that when such structures are used for authentication and information coding, fabrication of duplicates or “fakes” is very challenging. Further, electrochemically fabricated dendritic structures also possess complex topographic relief or

surface structure (i.e., in the “height” dimension orthogonal to the plane of the dendritic structure). An example of this terrain-like surface topography is shown in FIG. 4.

The particular surface structural pattern of a dendritic structure is a direct result of electrodeposition at the interface between the electrolyte and the growing dendritic structure.

5 The peaks of the ridges are the first to form on the electrolyte surface, and correspond to the initial laterally-grown surface dendritic structure. Continued basal deposition fed from the underlying electrolyte forces the peaks upwards and simultaneously broadens the foundation of the electrodeposited structure. As a result, higher peaks with broader bases are obtained in regions of the dendritic structure that correspond to early growth (i.e., near the cathode),  
10 compared to later-formed branches of the structure.

Typically, the overall shapes of the valleys and ridges within the dendritic structure are governed by the initial stochastic growth process, but additional smaller scale features are also evident. These arise because later growth is also driven by the same stochastic processes which are responsible for the lateral dendritic structure growth. The combination of stochastic lateral  
15 features of the dendritic structure and stochastic vertical topography yields dendritic structures with highly complex structural features that would be extremely difficult to reproduce with precision, making counterfeiting unlikely.

For dendritic structures of relatively small diameter (e.g., a few millimeters or less), the surface height is typically approximately 100 nm near the cathode, and less than 50 nm near the  
20 terminations of the branches. These dimensions are considerably smaller than visible light wavelengths. Accordingly, when such dendritic structures are imaged with non-polarized light, they appear “flat”, lacking apparent three-dimensional character. FIG. 68 shows an image of a dendritic structure acquired by illuminating the structure with unpolarized radiation. Surface relief and topographical variation of the dendritic structure are not readily apparent in FIG. 68.

25 However, by using polarized radiation to image such structures, surface topographical features of the structures can be readily identified, even though the wavelength of the polarized radiation is significantly larger than the dimensions of the features. FIG. 69 is an image of the same dendritic structure shown in FIG. 68, but illuminated with linearly polarized light. The illumination direction in FIG. 69 is orthogonal to the plane of the figure. As shown in FIG. 69,  
30 the structure between the pointed electrodes has a three-dimensional appearance, with variations in surface height readily apparent among different regions of the structure.

Another image of a dendritic structure illuminated with linearly polarized illumination light is shown in FIG. 70. In this image, which is obtained by detecting a portion of the reflected illumination light from the dendritic structure, the surface topographic (and hence, three-dimensional nature) of the dendritic structure is apparent, with certain portions of the structure appearing to be brightly illuminated and other portions of the structure appearing to be shadowed.

As shown in FIG. 70, the apparent direction of illumination of the dendritic structure in the plane of the image is from the lower right corner, although the actual direction of illumination (i.e., the propagation direction of the linearly polarized illumination radiation) is normal to the plane of FIG. 70. The apparent direction of illumination varies as the polarization direction of the linearly polarized illumination radiation varies. This aspect of the response of the dendritic structure to polarized illumination radiation can be used to authenticate a candidate structure as a real dendritic structure, rather than a counterfeit structure such as a two-dimensional attempted copy.

In some embodiments, to perform an authentication, a candidate structure is first illuminated with radiation that is linearly polarized along a first polarization direction, and a first image of reflected illumination radiation from the dendritic structure is obtained. FIG. 70 shows an example of such a first image.

The candidate structure is then illuminated with radiation that is linearly polarized along a second polarization direction different from the first polarization direction. A second image of reflected illumination radiation from the dendritic structure is obtained. Because the linear polarization directions of the illumination radiation used to generate the first and second images are different, the apparent directions of illumination in the first and second directions will be different.

Various methods can be used to determine whether the candidate structure is an authentic dendritic structure based on the first and second images. For example, a set of pixels common to both the first and second images can be identified (e.g., the pixels corresponding to region 70002 in FIG. 70), and a change in average pixel intensity for the set of pixels can be determined between the first and second images to effectively determine whether the apparent direction of illumination of the dendritic structure has changed in the images. If the change in average pixel intensity is sufficiently large, the candidate structure can be authenticated as a dendritic structure.

In general, changes in images of dendritic structures can manifest as changes in the apparent direction of illumination of the dendritic structures, as apparent shifts in position of the dendritic structures, and/or as changes in various other aspects of the structures. Typically, these variations can all be captured as changes in individual pixel intensities in images of the structures. It has been discovered that the extent of the changes in successive images of a dendritic structure captured under different polarization settings is a complex function of several factors, including the morphology of the dendritic structure, the substrate material supporting the dendritic structure, and the nature of the polarizer material.

A variety of different materials can be used to form polarizers for use in imaging dendritic structures. In certain examples discussed below, images of dendritic structures are obtained with a Mitutoyo Ultraplan model FS110 microscope (available from Mitutoyo America, Novi, MI), equipped with an integrated linear polarizer. More generally, polarizers used to obtain images of dendritic structures and/or to illuminate dendritic structures with polarized illumination radiation can be formed, for example, from polymer sheets, from liquid crystal based materials, and from naturally occurring materials such as calcite and mica.

It has been observed that the extent of change of pixel intensities in images of dendritic structures imaged under different linear polarization directions depends on the thickness of the dendritic structures. For example, dendritic structures with thicknesses of several hundred nanometers have been observed, in some examples, to show significant pixel intensity changes in images that correspond to linear polarization directions of incident radiation that differ by as little as 10 to 15 degrees. Certain dendritic structures with thicknesses of less than 100 nm, all other conditions being similar, have been observed to show significant pixel intensity changes in images that correspond to incident radiation with linear polarization directions that differ by approximately 30 degrees or more.

FIGS. 75A and 75B are images of an example dendritic structure (trunk length of approximately 50 microns) corresponding to relative linear polarization directions of 0 degrees and 90 degrees, respectively. For each image, the illumination radiation propagates along a direction normal to the dendritic structure (i.e., normal to the planes of the figures). It is evident that between these images, there is both a slight shift in the apparent position and a change in brightness of certain features of the dendritic structure.

For authentication purposes, in certain embodiments, images of a dendritic structure corresponding to a 90 degree difference in polarization angle (i.e., orthogonal polarization directions) are obtained and analyzed. More generally, however, the difference in polarization angle between two images used for authentication can be smaller than 90 degrees. For example, 5 for a first image corresponding to a first polarization angle or direction and a second image corresponding to a second polarization angle or direction, in some embodiments the minimum difference between the first and second polarization angles is at least 80° (e.g., at least 81°, at least 82°, at least 83°, at least 84°, at least 85°, at least 86°, at least 87°, at least 88°, at least 89°).

The foregoing differences in polarization can be particularly useful for relatively thin 10 dendritic structures. For thicker dendritic structures, as explained above, the minimum difference between the first and second polarization angles can be at least 10° (e.g., at least 20°, at least 30°, at least 40°, at least 50°, at least 60°, at least 70°).

The nature of the substrate supporting the dendritic structure has also been observed to influence the magnitude of pixel intensity changes in images of dendritic structures obtained at 15 different polarization angles. For example, for certain dendritic structures grown on a thin (approximately 100 nm) solid electrolyte layer deposited on a substrate with a SiO<sub>2</sub> layer (having a thickness of the order of a few or several hundred nanometers) on a silicon wafer, pixel intensity changes suitable for authentication of the dendritic structure between images that correspond to changes in polarization angle of as little as 10 degrees have been observed.

As discussed above, pixel intensity changes among two or more images of a dendritic 20 structure corresponding to different polarization angles are used to authenticate the dendritic structure as genuine. Pixel intensity changes can manifest as changes in an apparent illumination direction of the dendritic structure, changes in the apparent position of the dendritic structure (i.e., when registered to a common reference point among the images), changes in apparent 25 shape, dimensions, or other geometrical aspects of the dendritic structure, and other attributes of the dendritic structure. In some embodiments, such pixel intensity changes can be used for authentication purposes if they are merely detectable, e.g., above a background level of pixel intensity variation or noise in the images. Alternatively, or in addition, such pixel intensity changes can be used for authentication purposes if they exceed a threshold value for statistical 30 significance. That is, in these examples, a candidate structure is authenticated as a dendritic structure if a change in pixel intensities (e.g., a change in average pixel intensity) is measured for

a set of pixels common to two or more images corresponding to different polarization angles, and/or if the change is larger than a threshold value for statistical significance.

In certain embodiments, a candidate structure can be authenticated as a dendritic structure if the observed change in average pixel intensity for a set of pixels common to two or more  
5 images corresponding to different polarization angles is larger than 1% (e.g., larger than 2%, larger than 3% , larger than 5%, larger than 7%, larger than 10%, larger than 15%, larger than 20%, larger than 30%, larger than 40%, larger than 50%).

In some embodiments, a candidate structure can be authenticated as a dendritic structure if one or more changes in pixel intensity between two images of the structure corresponding to  
10 different polarization angles is visually observed. This provides a convenient method by which a rapid assessment of authenticity can be made, without involving detailed image analysis. A human observer can merely verify visually that certain intensity changes are apparent when comparing two or more images of a candidate structure corresponding to different polarization angles, and on this basis, can authenticate the structure as a genuine dendritic structure.

15 In some embodiments, similar measurements can be performed for two sets of pixels that are common to both the first and second images, with the candidate structure authenticated as a dendritic structure only if the changes are observed for both sets of pixels, or only if changes in average pixel intensity for both sets of pixels are larger than any of the values discussed above. Returning to FIG. 70, a second pixel set used for authentication corresponds to region 70004.  
20 The authentication procedure can be further extended to include any number of pixel sets (e.g., three or more, four or more, five or more, seven or more, ten or more, or even more) common to both images.

Various methods can be used to calculate the change in average pixel intensity for a set of pixels between the first and second images. In certain embodiments, for example, a normalized  
25 average pixel intensity is determined for the set of pixels in each image. To determine the normalized average pixel intensity, a reference point 70006 is first selected that corresponds to a region of the image that does not correspond to the candidate structure. The reflected radiation intensities for reference point 70006 in the first and second images are  $I_R(1)$  and  $I_R(2)$ , respectively.

30 The normalized average pixel intensities for the  $p$  pixels in the first and second images,  $P(1)$  and  $P(2)$ , can then be calculated as:

$$P(1) = \frac{\sum_{i=1}^p I_i(1)}{p \cdot I_R(1)} \tag{28}$$

$$P(2) = \frac{\sum_{i=1}^p I_i(2)}{p \cdot I_R(2)}$$

where  $I_i(1)$  and  $I_i(2)$  are individual pixel intensities for the set of pixels in the first and second images, respectively.

The change in average pixel intensity,  $\Delta P$ , can then be determined from  $P(1)$  and  $P(2)$ . For example, in some embodiments,  $\Delta P$  can be calculated as:

$$\Delta P = \frac{|P(1) - P(2)|}{P(1)} \tag{29}$$

10

which can be expressed as a percentage, as discussed above.

In some embodiments, the change in average pixel intensity can be facilitated by calculating a difference image between the first and second images. For example, pixel-by-pixel subtraction of the intensity values of the second image from those of the first image can be performed. Then, the average change in pixel intensity can be determined from the set of pixel intensity differences that corresponds to region 70002 in the difference image, for example. When the determination is performed in such a manner, the pixel intensity differences can be normalized by selecting a reference location 70006 or a reference region 70008 and determining a reference pixel intensity from location 70006 or by averaging the pixel intensities within region 70008, and then using the reference pixel intensity to normalize the pixel intensities in the first and second images prior to calculating the difference image.

In certain embodiments, the set of pixels corresponding to region 70002 can be identified after calculating a difference image between the first and second images. Because the difference image typically highlights groups of pixels for which larger pixel intensity variations occur, a suitable set of pixels can be identified manually or automatically based on the difference image,

25

e.g., a set of pixels for which pixel intensities of at least 25% of the pixels increase and for which pixel intensities of at least 25% of the pixels decrease.

In some embodiments, to further facilitate authentication of the candidate structure, the apparent illumination directions associated with the first and second images can be determined, and the candidate structure can be authenticated if an angle between the apparent illumination directions is at least  $3^\circ$  (e.g., at least  $5^\circ$ , at least  $7^\circ$ , at least  $10^\circ$ , at least  $12^\circ$ , at least  $15^\circ$ , at least  $18^\circ$ , at least  $20^\circ$ ).

Various methods can be used to determine the apparent illumination directions for the first and second images. In certain embodiments, for example, the apparent illumination directions can be determined by examining pixel intensities along a reference line through the candidate structure. To determine apparent illumination directions in this manner, a reference location 70010 on the candidate structure is first selected within a portion of the candidate structure that is brightly reflective. Then, pixel intensities along a reference line 70012 that extends through location 70010 are examined to determine a length of a “shadow region” behind the brightly reflective portion of the candidate structure. The length of the shadow region can be determined, for example, as the distance over which the pixel intensity along reference line 70012 falls from a maximum value to a value that is less than or equal to a background value in the image.

The process is repeated for multiple reference lines 70012, each extending through location 70010, but rotated about location 70010 relative to one another. The apparent direction of illumination corresponds to the orientation of the reference line 70012 for which the length of the shadow region is longest. It should be noted that the foregoing methods for determining the length of the shadow region and apparent direction of illumination are merely examples, and other methods can also be used.

After the candidate structure has been authenticated as a dendritic structure, the structure can be analyzed as discussed above to extract information from the structure. For example, in some embodiments, a set of reference locations and reference intensities (i.e., pixel intensities at the reference locations) can be selected from one of the first and second images, and various attributes of the dendritic structure – such as branch points, segment lengths, segment angles, and distances of reference locations from a particular structural point or indicator – can be

determined, and used to construct a reference identifier (such as a base  $n$  numerical value) for the dendritic structure.

In certain embodiments, the reference identifier for the dendritic structure can include a data structure that features the sets of reference locations and reflected radiation intensities at the reference locations, and can optionally include other information such as a polarization direction of the illumination radiation. In some embodiments, the reference identifier for the dendritic structure can be constructed as a sequence of reflected radiation intensities corresponding to an ordered sequence of the reference locations. Any of the foregoing examples of reference identifiers for the dendritic structure can then be used for future authentication operations based on the dendritic structure.

FIG. 71 shows a schematic diagram of a system 71000 for authenticating candidate structures according to the foregoing methods. System 71000 includes a radiation source 71002, a first polarizing element 71004, and a detector 71010. Radiation source 71002 and detector 71010 are connected to an electronic processor 71012. First polarizing element 71004 can also, optionally, be connected to processor 71012 (connection not shown in FIG. 71 for clarity). During operation, radiation source 71002 generates radiation, which passes through first polarizing element 71004, producing linearly polarized illumination radiation 71006. A portion of radiation 71006 is reflected from candidate structure 71014 as reflected radiation 71008, which is imaged by detector 71010. The image information is transmitted to electronic processor 71012 for processing according to the methods disclosed herein.

For certain applications, it can be desirable to use dendritic identifiers that include a hidden dendritic structure. For example, a dendritic structure can be grown beneath a coating layer that functions as a diffuse reflector of incident light. Alternatively, a coating that implements similar functionality can be applied atop a dendritic structure following fabrication. In either situation, the dendritic structure is not readily visible when imaged with unpolarized illumination radiation.

FIG. 72 shows an image of a credit card that includes a dendritic identifier 72002 with a dendritic structure concealed beneath a diffuse reflecting coating layer, such that the underlying dendritic structure is not visible. In this example, the dendritic structure is formed of silver and is fabricated on a Teslin synthetic paper substrate which was vacuum coated prior to fabrication of the dendritic structure with a 100 nm solid electrolyte film. The dendritic structure is

positioned at the interface between the synthetic Teslin paper and the solid electrolyte film. The solid electrolyte film functions as the light diffusing reflective layer.

As shown in FIG. 72, the underlying dendritic structure is not successfully imaged with incident unpolarized radiation. Instead, to image the dendritic structure through the overlying reflective diffusing layer of solid electrolyte, a double-polarization technique is used. FIG. 73 shows a schematic diagram of an imaging system 73000 that includes a radiation source 73002, a first polarizing element 73004, a second polarizing element 73016, a detector 73010, and an electronic processor 73012. Radiation source 73002 and detector 73010 are connected to processor 73012, and each of the polarizing elements 73004 and 73016 can optionally be connected to processor 73012 (connections not shown to maintain clarity in FIG. 73).

Radiation generated by source 73002 passes through first polarizing element 73004, generating linearly polarized illumination radiation 73006, which is incident on dendritic identifier 73020. As discussed above, dendritic identifier 73020 can include a solid electrolyte layer 73022, a synthetic Teslin paper substrate 73026, and a dendritic structure 73024 formed at the interface between layer 73022 and substrate 73026. Illumination radiation is reflected from both the surface of electrolyte layer 73022 and from dendritic structure 73024, forming reflected radiation 73008. Reflected radiation 73008 passes through second polarizing element 73016, generating linearly polarized measurement light that is detected by detector 73010. Image information measured by detector 73010 is then transmitted to processor 73012.

An important aspect of system 73000 is the relative polarization orientations of the first and second polarizing elements 73004 and 73016. In general, the polarization direction of second polarizing element 73016 is orthogonal to, or nearly orthogonal to, the polarization direction of first polarizing element 73004. By orienting the polarization directions in such a manner, reflected radiation from the surface of electrolyte layer 73022 can be reduced or even excluded from the measurement light, such that most or all of the measurement light corresponds to illumination radiation reflected from dendritic structure 73024 and passing through electrolyte layer 73022 before being imaged by detector 73010.

FIG. 74A shows an image of a dendritic identifier with a hidden dendritic structure, imaged using unpolarized illumination radiation. The underlying dendritic structure is not visible in the image. FIG. 74B shows an image of the same dendritic identifier imaged using the double polarization technique of FIG. 73. The form of the underlying dendritic structure is

readily apparent in FIG. 74B, and can be analyzed using any of the methods discussed previously to determine representations of the structure and extract encoded information from the structure.

As discussed above, to effectively reduce or exclude reflected radiation from the surface of electrolyte layer 73022 from the measurement radiation, the first and second polarization  
5 directions are orthogonal or nearly orthogonal. For example, in some embodiments, a minimum angle between the first and second polarization directions is at least  $80^\circ$  (e.g., at least  $81^\circ$ , at least  $82^\circ$ , at least  $83^\circ$ , at least  $84^\circ$ , at least  $85^\circ$ , at least  $86^\circ$ , at least  $87^\circ$ , at least  $88^\circ$ , at least  $89^\circ$ ).

In certain embodiments, polarized images of a dendritic structure corresponding to different polarization angles can be analyzed using the methods discussed previously to construct  
10 mathematical representations of the structure in each image, e.g., in terms of branch points, line segments, and other such features. The representations of the structure in each image can then be compared to determine whether an apparent shift of the structure has occurred and/or whether apparent changes have occurred in the shape, orientation, and/or dimensions of any of the features of the structure. Further, a mathematical representation of the apparent direction of  
15 illumination in each image can be determined and used to assess the authenticity of the structure, e.g., by comparing the determined apparent direction of illumination to authentication information that includes a previously determined value of the apparent direction of illumination for the structure under similar illumination conditions.

Alternatively, or in addition, in some embodiments one or more images of a candidate  
20 structure corresponding to one or more polarization angles can be compared directly to stored image information (e.g., stored raw images) of an authentic dendritic structure for authentication purposes. Since the appearance of a dendritic structure depends on the interaction of polarized illumination radiation with the surface morphology of the structure, the unique surface of each dendritic structure leads to a unique image corresponding to any given polarization angle.  
25 Multiple images of the same dendritic structure corresponding to multiple different polarization angles therefore constitute a set of images that are all unique to that dendritic structure, and can therefore be used for authentication purposes. The larger the number of images in the set, the greater the certainty to which a candidate structure can be authenticated if the images are successfully matched to a set of corresponding database images.

30 Direct comparisons between raw data in measured and stored images can, in certain embodiments, significantly increase search time, relative to comparisons between mathematical

representations of dendritic structures. In some embodiments, an identifier such as a numerical, alphabetical, and/or alphanumeric identifier can be affixed to or associated with each candidate dendritic structure. For example, such an identifier can be printed or imprinted lithographically on each dendritic structure, and scanned prior to performing the database comparison. In this way, direct comparisons can be performed between measured images of the candidate structure at different polarization angles and a single set of images in a database associated with the identifier (and the corresponding genuine dendritic structure). Thus, even for a database that contains a relatively large number of images, a candidate dendritic structure can be authenticated via direct image comparison with only a small subset of the database images, greatly reducing the amount of time consumed.

#### Additional Aspects and Features

Additional aspects and features of dendritic structures and their applications are disclosed, for example, in the following documents, the entire contents of each of which is incorporated herein by reference: PCT Patent Application Publication No. WO 2014/165047; PCT Patent Application Publication No. WO 2014/165148; and PCT Patent Application Publication No. WO 2016/073910.

#### Hardware and Software Implementation

The algorithmic and method steps disclosed herein in connection with controlling voltages and other fabrication parameters, obtaining images of dendritic tags, analyzing the images, authenticating and identifying articles to which such tags are attached, and controlling various aspects and operating parameters of devices that obtain tag images and devices that utilize such tags, can be implemented in computer programs using standard programming techniques. Such programs are designed to execute on control units, programmable computers, and/or specifically designed integrated circuits, each comprising an electronic processor, a data storage system (including memory and/or storage elements), at least one input device, and least one output device, such as a display or printer. The program code is applied to input data to perform the functions described herein and generate output information, which is applied to one or more output devices, such as a user interface that includes a display device. Each such computer program can be implemented in a high-level procedural or object-oriented

programming language, or an assembly or machine language. Furthermore, the language can be a compiled or interpreted language. Each such computer program can be stored on a tangible, computer readable storage medium (*e.g.*, CD ROM or magnetic diskette) that, when read by a computer or other device, can cause the processor to perform the analysis and control functions  
5 described herein.

### **OTHER EMBODIMENTS**

A number of embodiments have been described. Nevertheless, it will be understood that various modifications may be made without departing from the spirit and scope of the disclosure.  
10 Accordingly, other embodiments are within the scope of the following claims.

**WHAT IS CLAIMED IS:**

1. A method, comprising:
  - illuminating a candidate structure with radiation linearly polarized along a first
  - 5 polarization direction and obtaining a first image of the dendritic structure;
  - illuminating the candidate structure with radiation linearly polarized along a second
  - polarization direction and obtaining a second image of the dendritic structure, wherein an angle
  - between the first and second polarization directions is at least  $10^\circ$ ;
  - for a set of pixels corresponding to a first region of the candidate structure in the first and
  - 10 second images, determining a first change in average pixel intensity between the first and second
  - images; and
  - authenticating the candidate structure as a dendritic structure based on the first change in
  - average pixel intensity.
- 15 2. The method of claim 1, further comprising:
  - for a set of pixels corresponding to a second region of the candidate structure in the first
  - and second images, determining a second change in average pixel intensity between the first and
  - second images; and
  - authenticating the candidate structure as a dendritic structure based on both the first and
  - 20 second changes in average pixel intensity.
3. The method of claim 1, wherein determining the first change in average pixel intensity
- comprises:
  - calculating a normalized average pixel intensity for the set of pixels in the first image;
  - 25 calculating a normalized average pixel intensity for the set of pixels in the second image;
  - and
  - determining the first change in average pixel intensity based on normalized average pixel
  - intensities for the set of pixels in the first and second images.
- 30 4. The method of claim 1, wherein determining the first change in average pixel intensity
- comprises calculating a difference image from the first and second images.

5. The method of claim 4, further comprising identifying the first region based on pixel intensity values in the difference image.
- 5 6. The method of claim 1, further comprising:  
determining an apparent illumination direction associated with the first image;  
determining an apparent illumination direction associated with the second image; and  
authenticating the candidate structure as a dendritic structure if an angle between the  
apparent illumination directions is at least  $3^\circ$ .
- 10 7. The method of claim 6, further comprising determining the apparent illumination  
directions in a plane of the candidate structure.
8. The method of claim 1, wherein each of the first and second images correspond to  
15 radiation reflected from the candidate structure in response to illumination of the candidate  
structure with the linearly polarized radiation.
9. The method of claim 1, further comprising, after authenticating the candidate structure as  
a dendritic structure:  
20 determining a set of reference locations and a set of reference reflected radiation  
intensities associated with the set of reference locations for the dendritic structure, wherein the  
sets of reference locations and reflected radiation intensities correspond to the first polarization  
direction; and  
determining an identifier associated with the dendritic structure based on the sets of  
25 reference locations and reflected radiation intensities.
10. The method of claim 9, wherein the identifier comprises a data structure based on the sets  
of reference locations and reflected radiation intensities.
- 30 11. The method of claim 9, wherein the identifier comprises a sequence of reflected radiation  
intensities.

12. A system, comprising:  
a radiation source;  
a radiation detector; and

5 an electronic processor connected to the radiation source and the radiation detector, and configured so that during operation, the electronic processor performs the method of any one of claims 1-11.

13. A method, comprising:

10 illuminating a dendritic identifier with radiation linearly polarized along a first polarization direction, wherein the illuminating radiation passes through a light diffusing coating and reflects from a dendritic structure within the dendritic identifier;

15 directing radiation reflected from the dendritic structure to pass through a polarizing element to generate measurement radiation linearly polarized along a second polarization direction;

detecting the measurement radiation to obtain an image of the dendritic structure; and  
extracting information from the dendritic identifier based on one or more structural features of the dendritic structure determined from the image,

20 wherein a minimum angle between the first and second polarization directions is at least 80°.

14. The method of claim 13, wherein the first and second polarization directions are orthogonal.

25 15. The method of claim 13, further comprising directing the radiation reflected from the dendritic structure to pass through the light diffusing coating before passing through the polarizing element.

30 16. The method of claim 13, wherein the one or more structural features of the dendritic structure comprise one or more branch points of the dendritic structure.

17. The method of claim 13, wherein the one or more structural features of the dendritic structure comprise one or more lengths of segments of the dendritic structure.

18. The method of claim 13, wherein the one or more structural features of the dendritic structure comprise one or more angles between segments of the dendritic structure.

19. The method of claim 13, wherein the one or more structural features of the dendritic structure comprise one or more distances of locations on the dendritic structure from a reference point.

20. The method of claim 13, wherein the one or more structural features of the dendritic structure comprise one or more angles of rotation of locations on the dendritic structure relative to a reference line.

21. The method of claim 13, wherein extracting information from the dendritic identifier comprises determining a base  $n$  digit associated with the dendritic identifier, wherein  $n$  is greater than or equal to 2.

22. The method of claim 21, wherein determining the base  $n$  digit comprises:  
comparing a value of a first one of the one or more structural features to at least one range of values associated with the first feature; and  
comparing a value of a second one of the one or more structural features to at least one range of values associated with the second feature,  
wherein the first and second features are each selected from the group consisting of an angle between segments of the dendritic structure, a length of a segment of the dendritic structure, a distance of a location on the dendritic structure from a reference point, and an angle of rotation of a location on the dendritic structure relative to a reference line.

23. The method of claim 13, wherein the one or more structural features comprise a set of coordinates associated with a spatial distribution of the dendritic structure on a coordinate system.

24. The method of claim 23, further comprising identifying the set of coordinates by determining portions of the coordinate system into which the dendritic structure extends.

- 5 25. A system, comprising:  
a radiation source;  
a first polarizing element positioned to receive radiation generated by the radiation source  
and to generate linearly polarized illumination radiation;  
a second polarizing element positioned to receive reflected radiation and to generate  
10 linearly polarized output radiation;  
a radiation detector; and  
an electronic processor connected to the radiation source and the radiation detector, and  
configured so that during operation, the electronic processor performs the method of any one of  
claims 13-24.

15

20

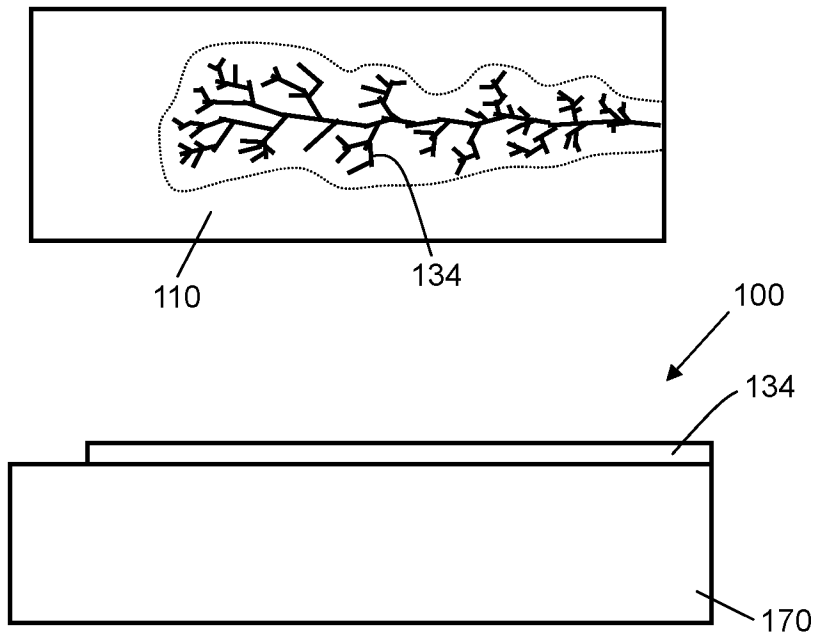

FIG. 1

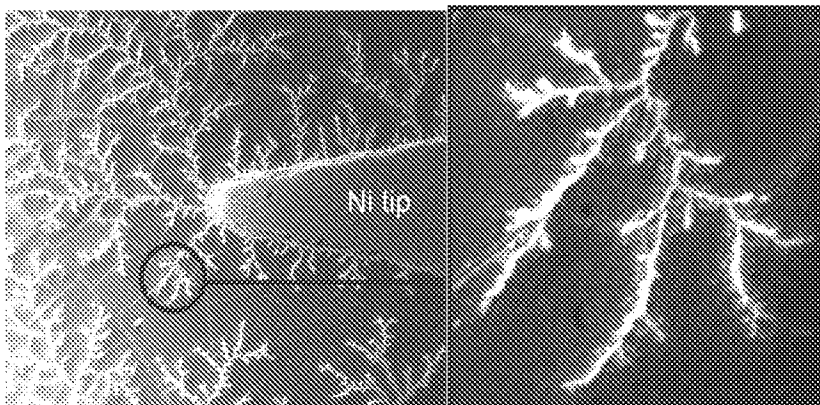

FIG. 2

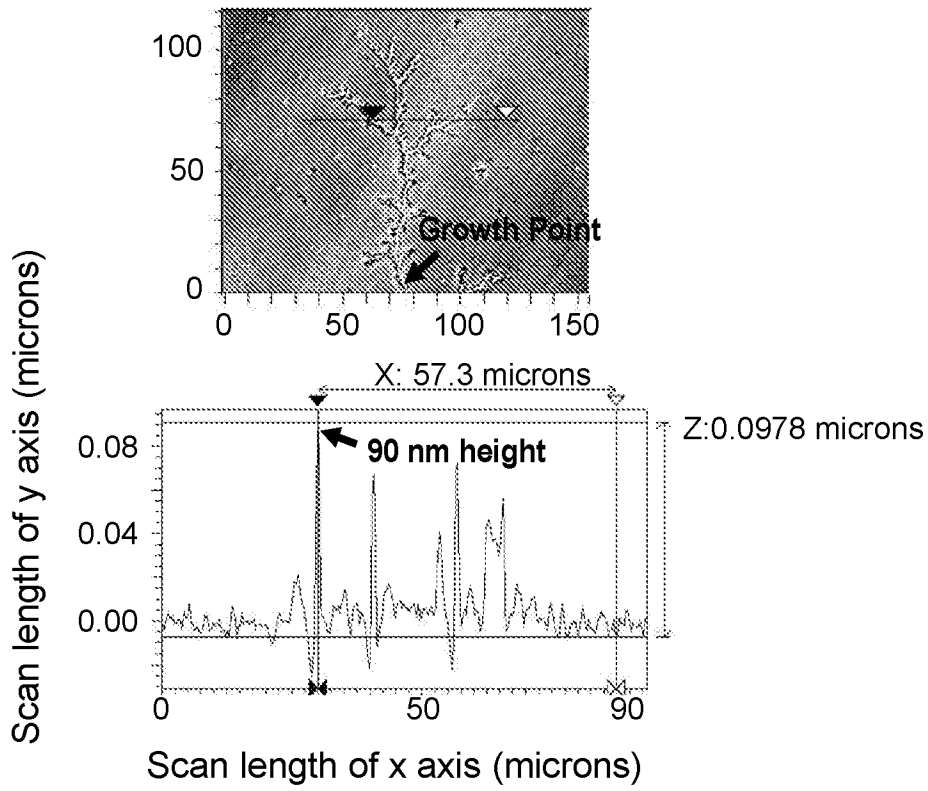

FIG. 3

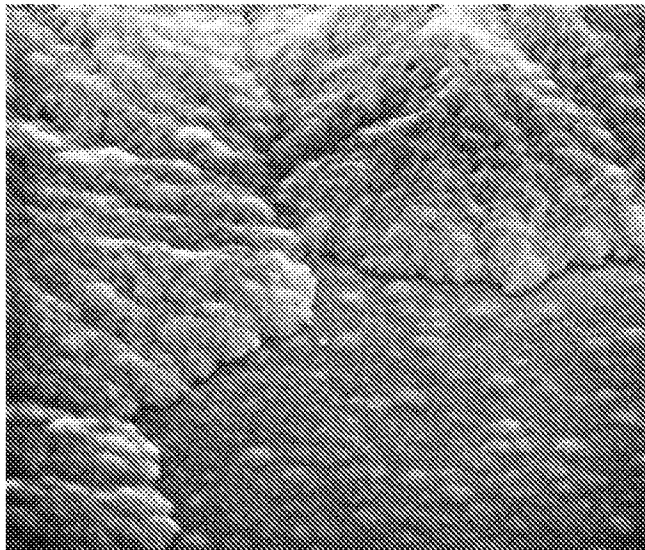

FIG. 4

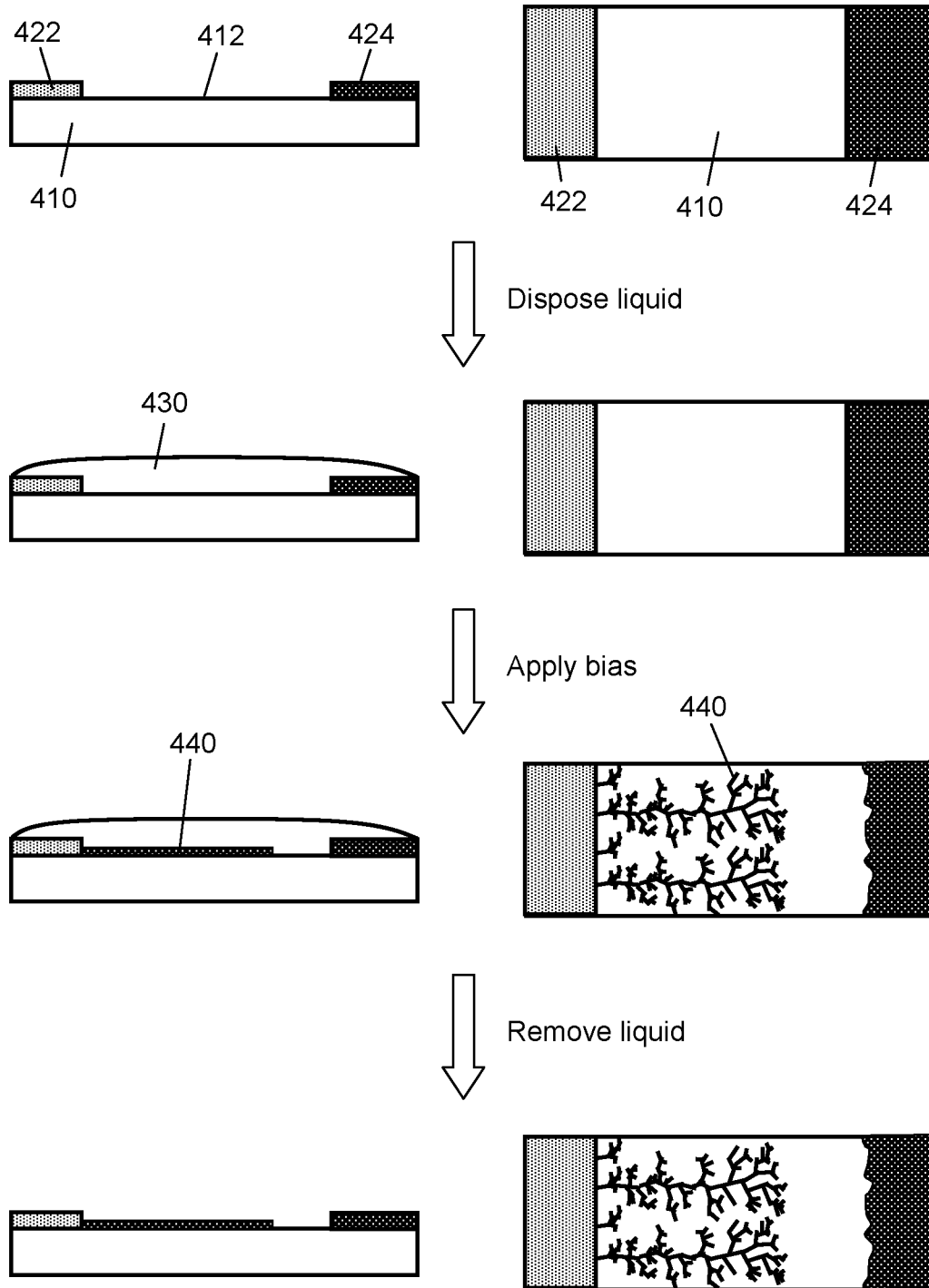

FIG. 5

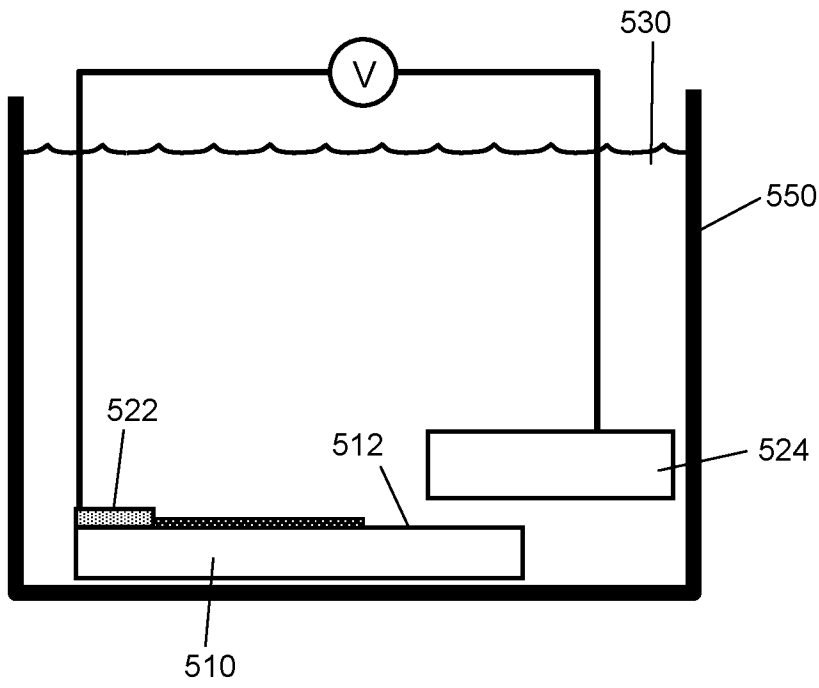

FIG. 6

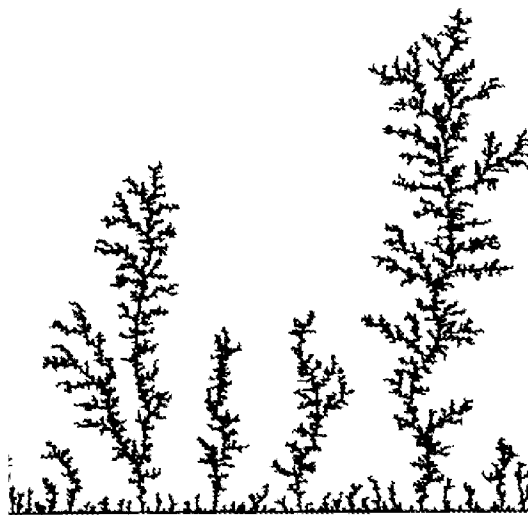

FIG. 7

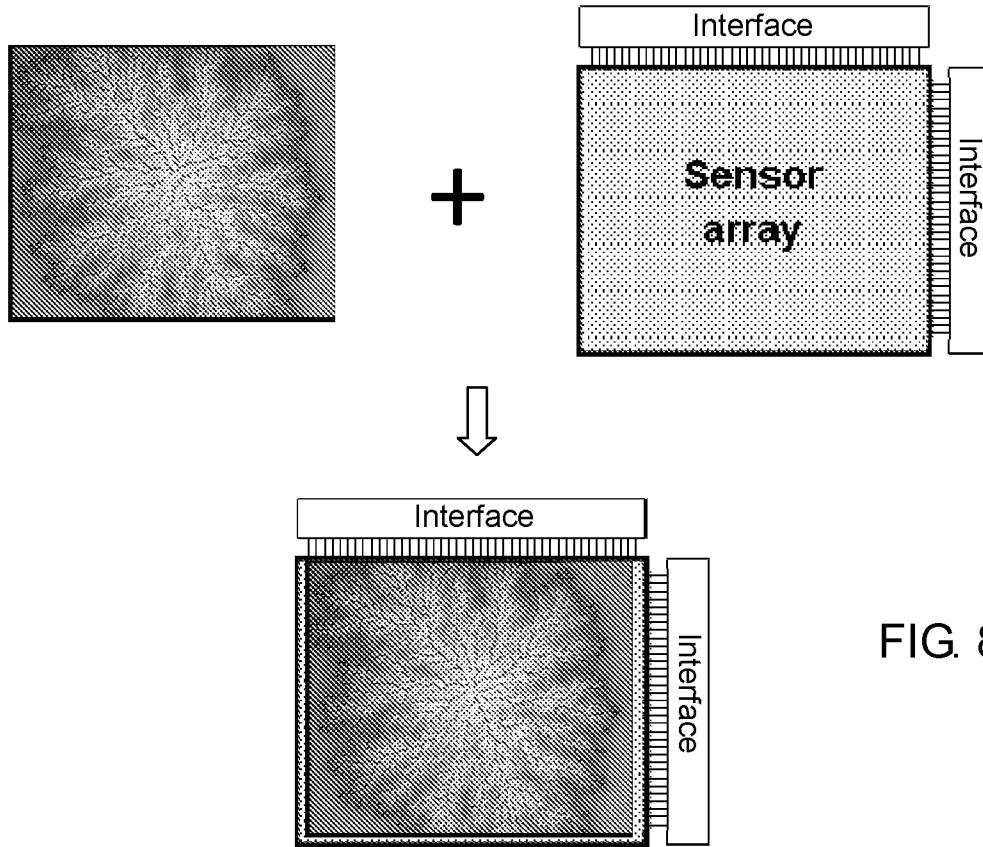

FIG. 8

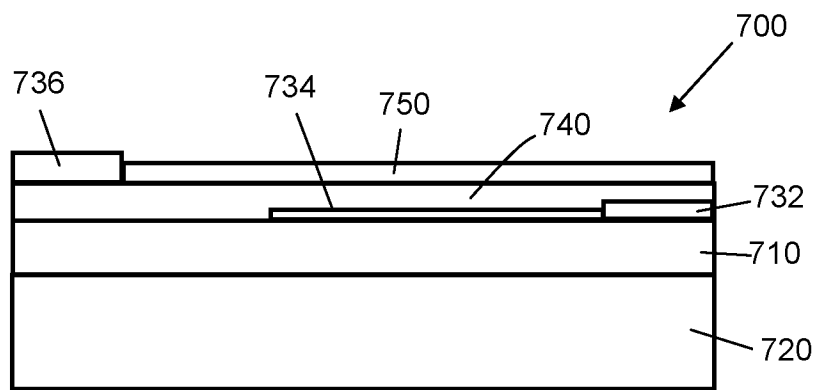

FIG. 9

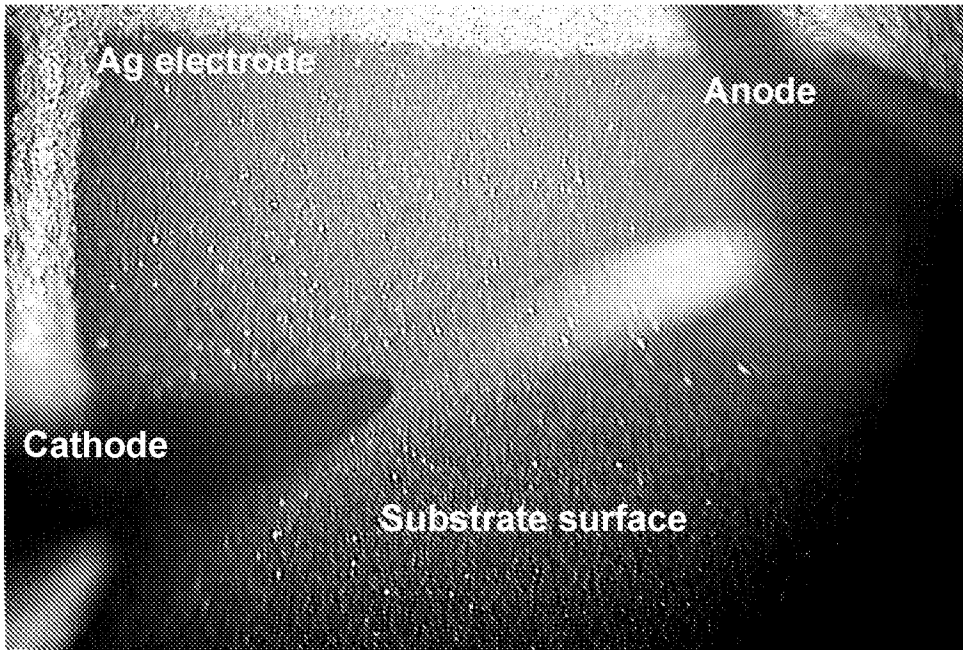

FIG. 10A

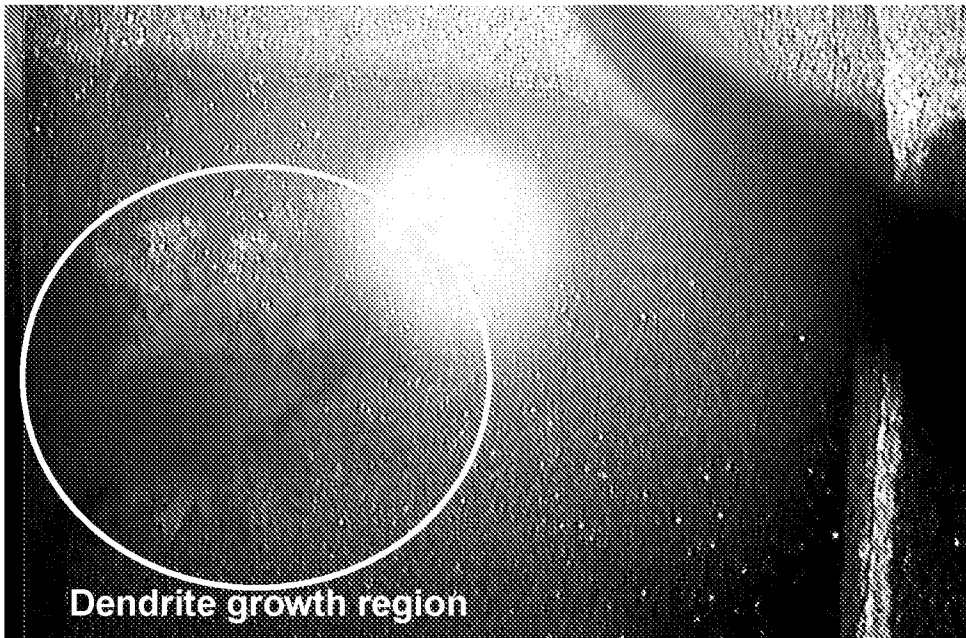

FIG. 10B

7/36

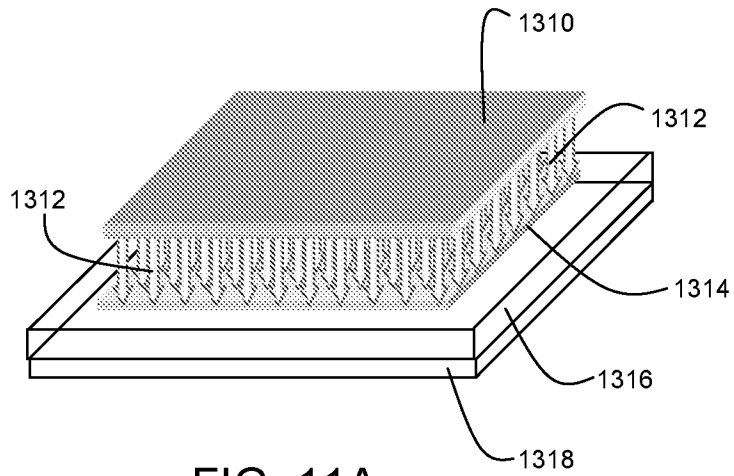

FIG. 11A

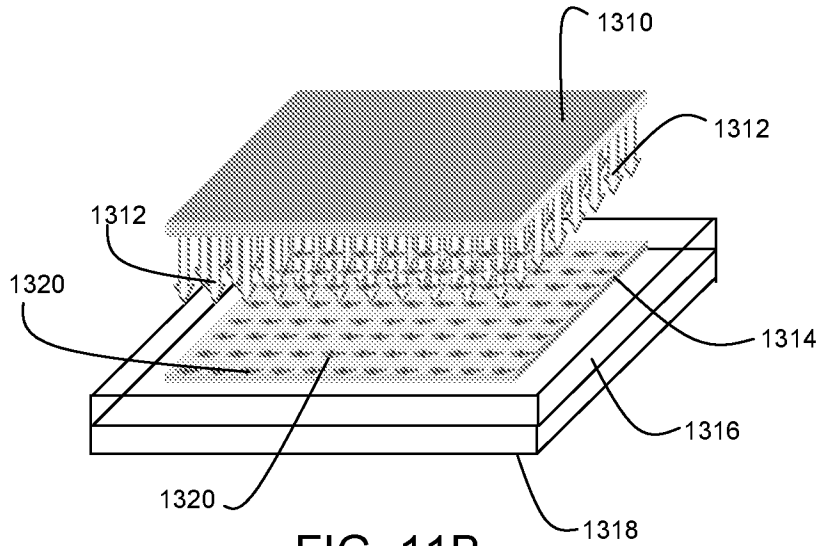

FIG. 11B

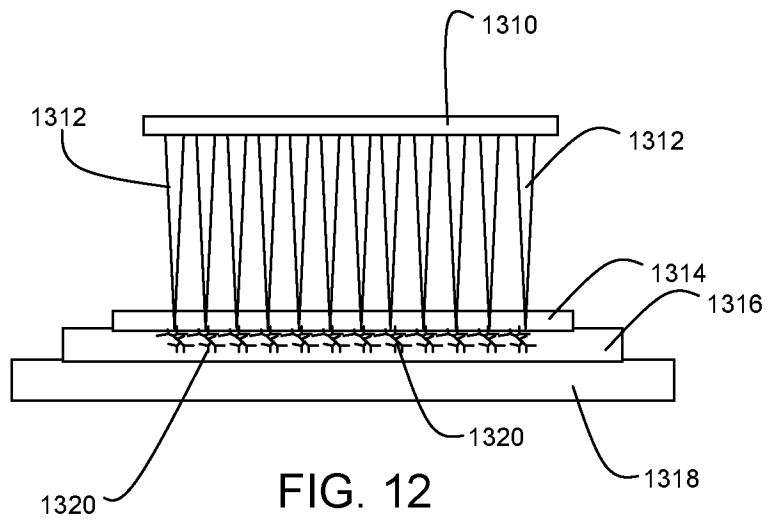

FIG. 12

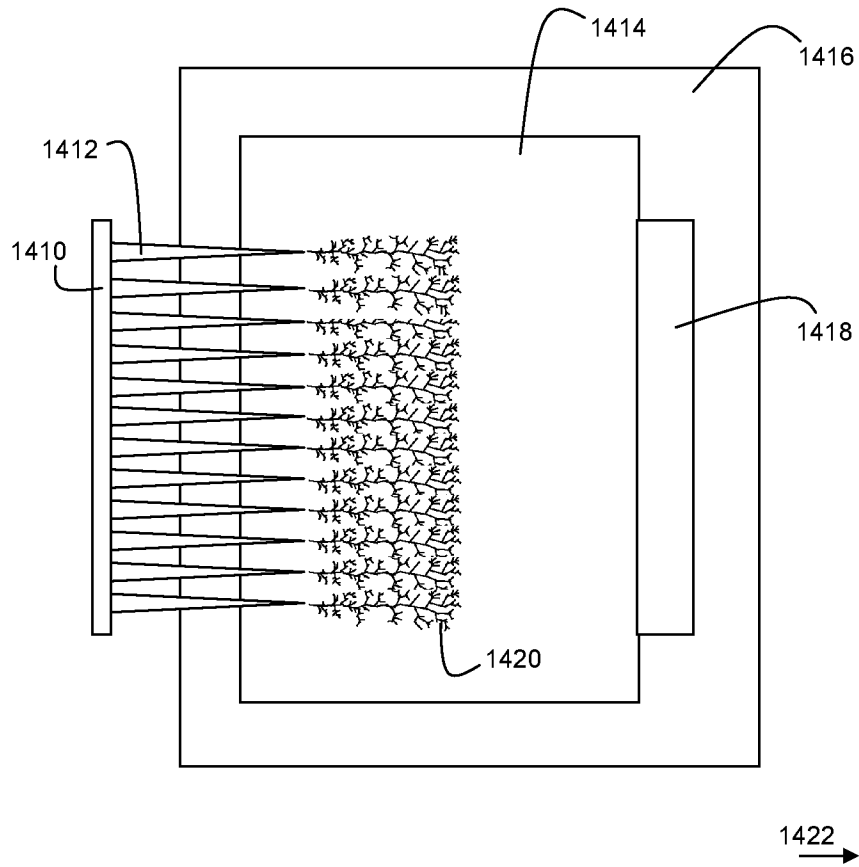

FIG. 13

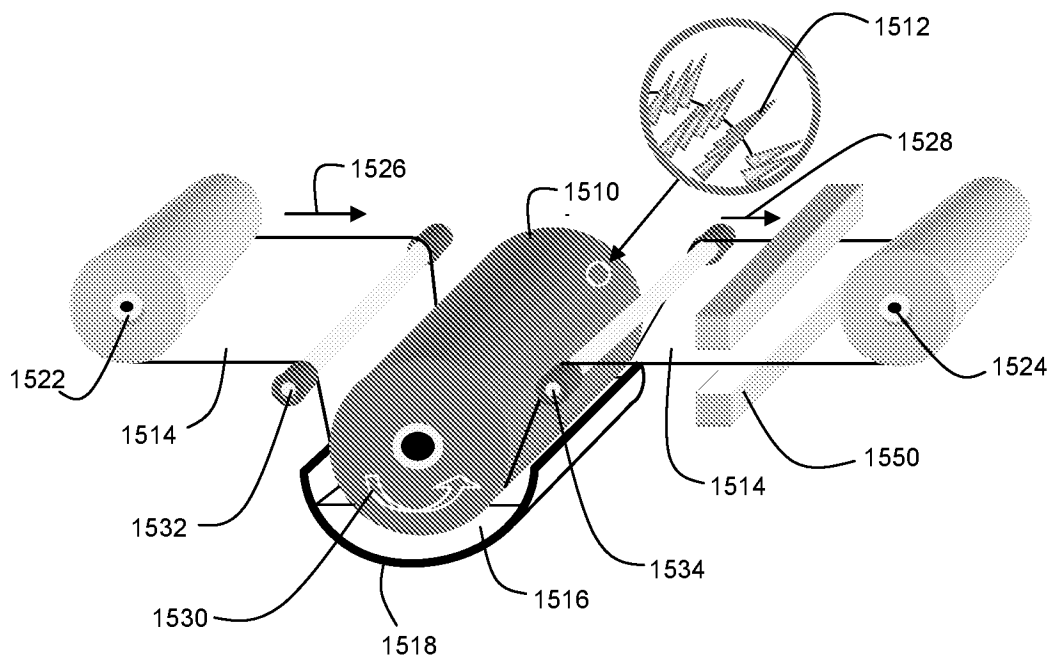

FIG. 14

9/36

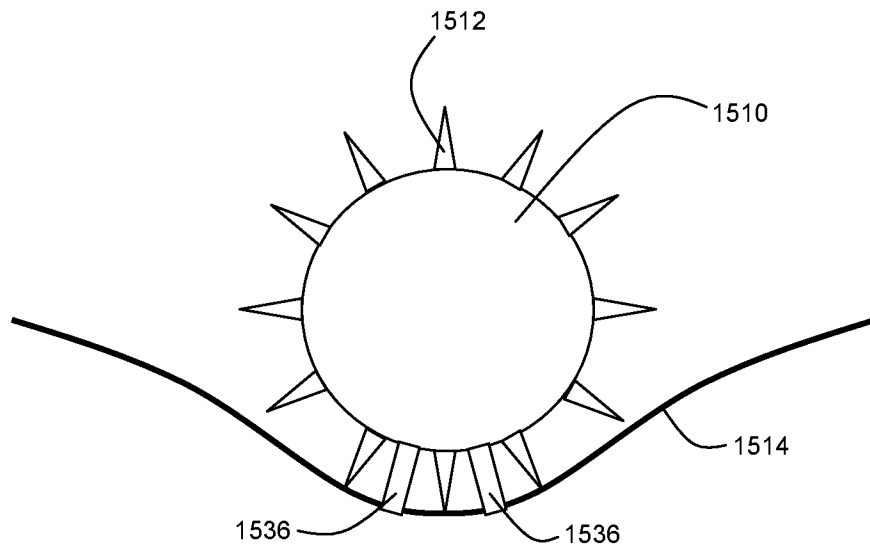

FIG. 15

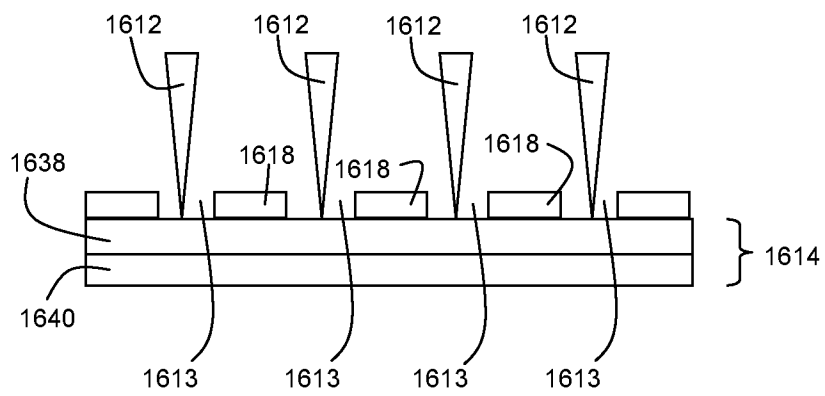

FIG. 16A

10/36

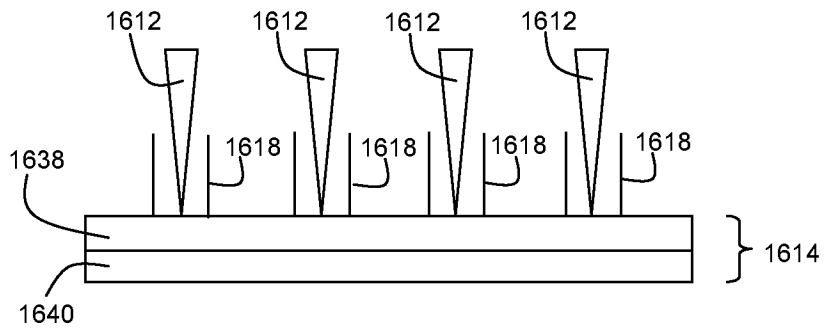

FIG. 16B

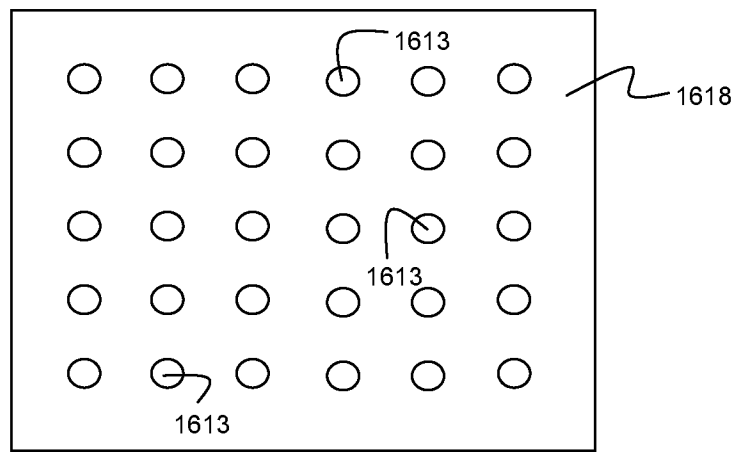

FIG. 16C

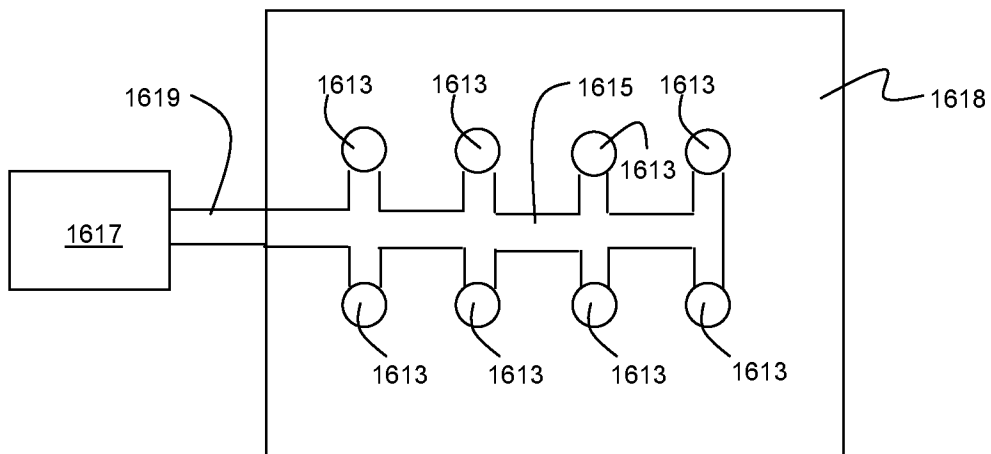

FIG. 16D

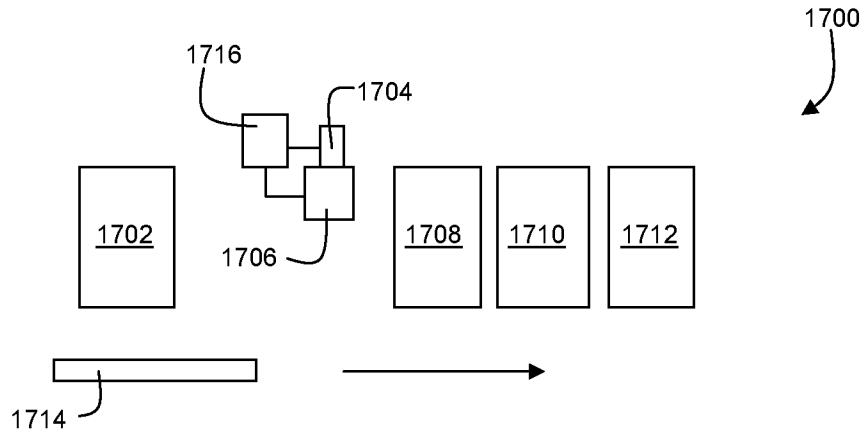

FIG. 17

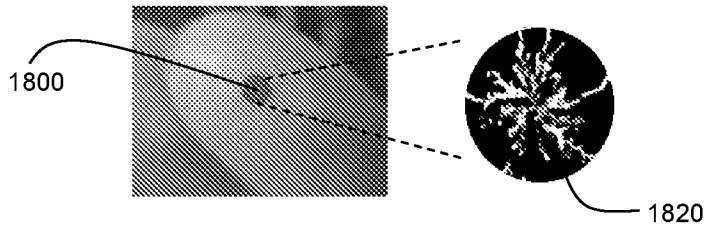

FIG. 18

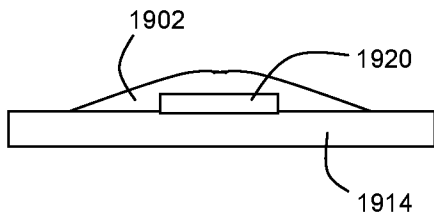

FIG. 19

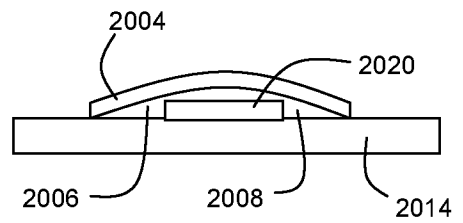

FIG. 20

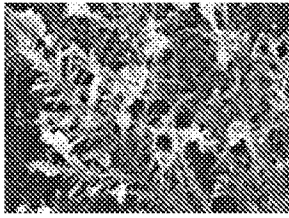

FIG. 21A



FIG. 21B

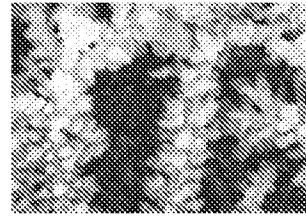

FIG. 21C

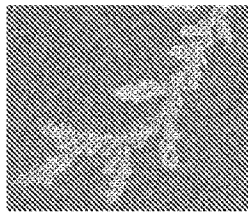

FIG. 22A

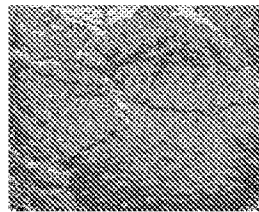

FIG. 22B

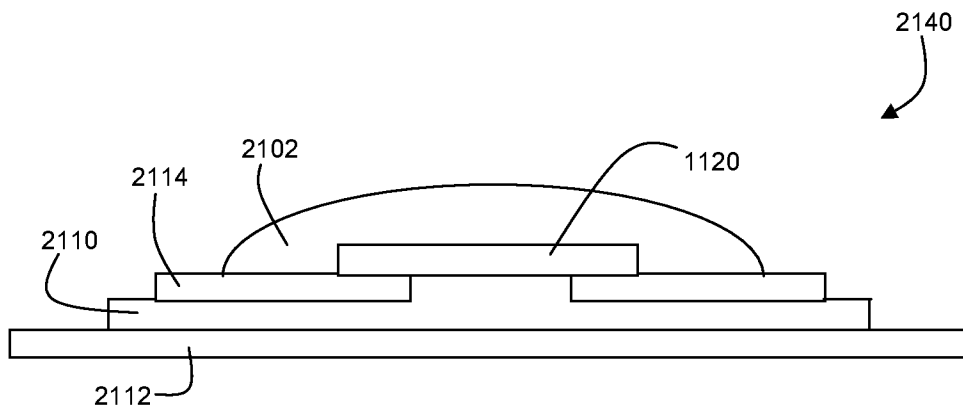

FIG. 23

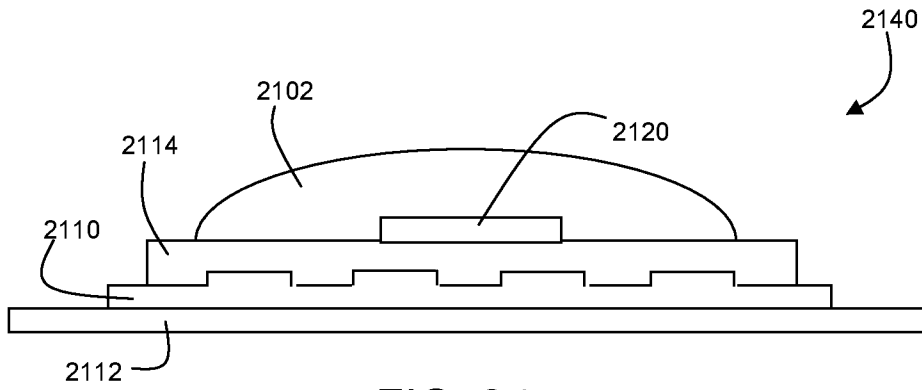

FIG. 24

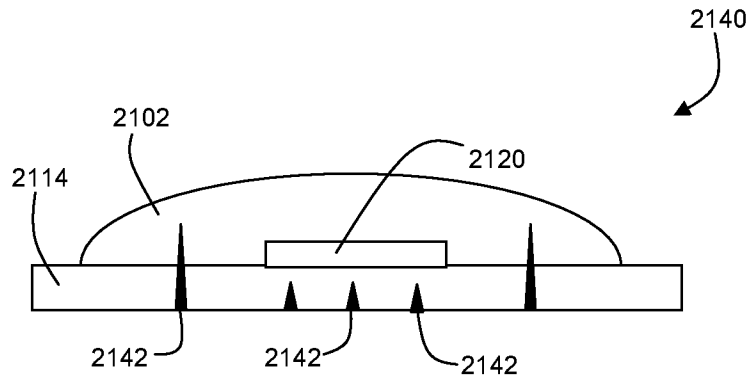

FIG. 25

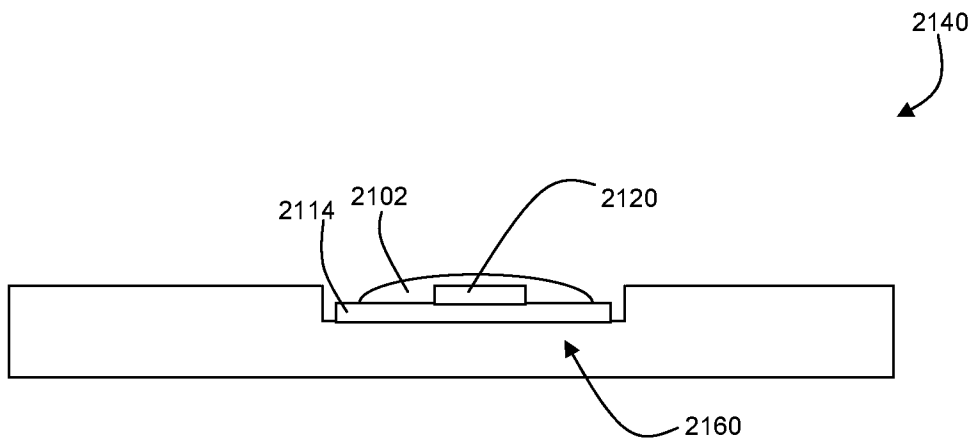

FIG. 26

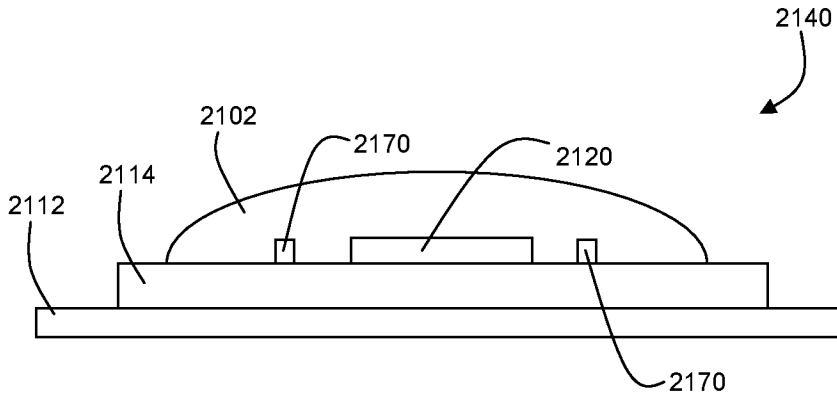

FIG. 27

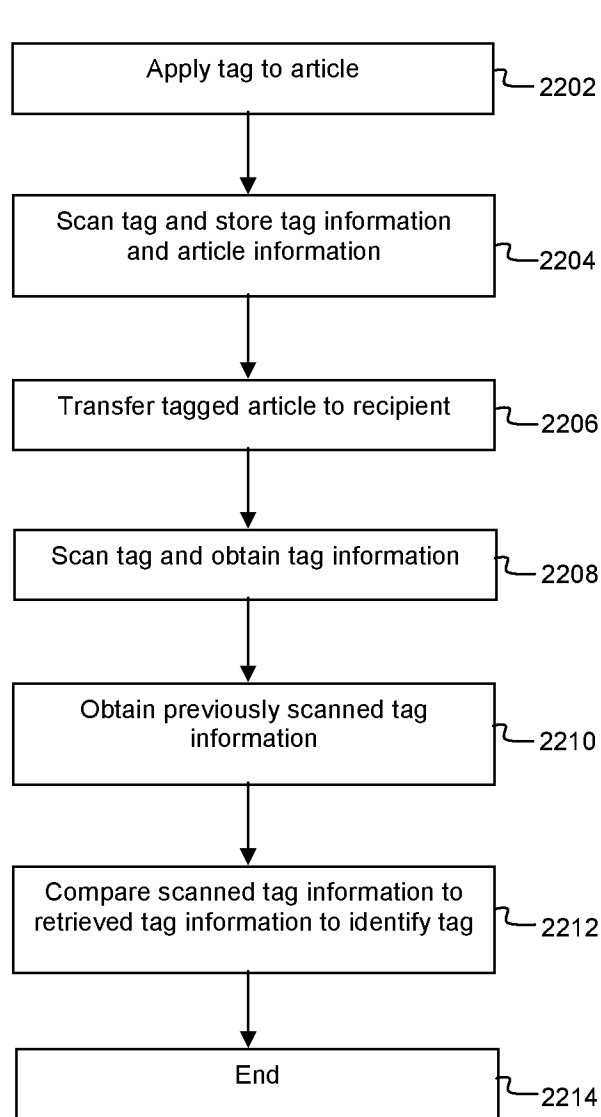

FIG. 28

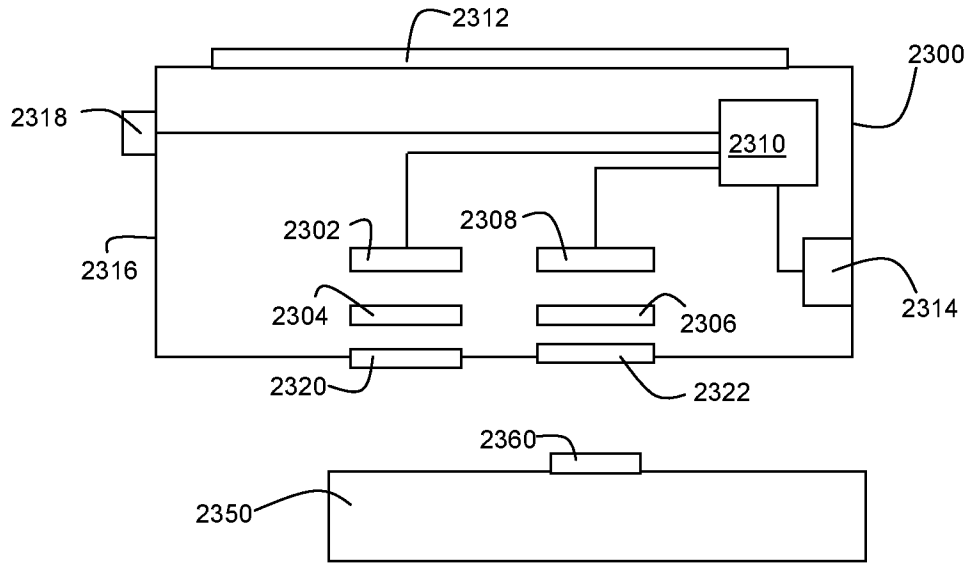

FIG. 29

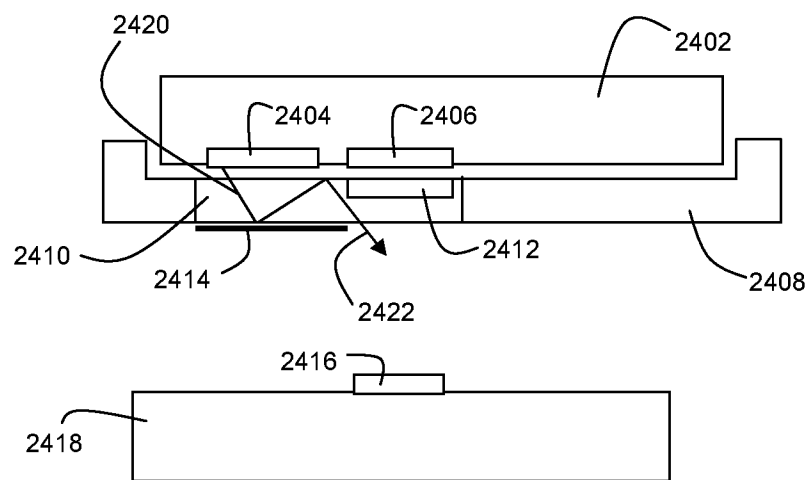

FIG. 30

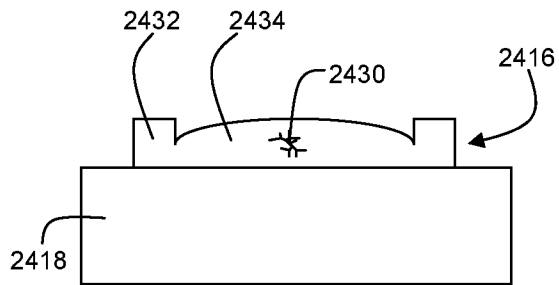

FIG. 31A

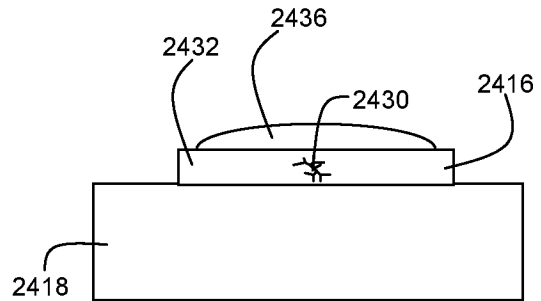

FIG. 31B

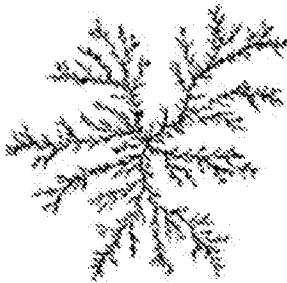

FIG. 32A

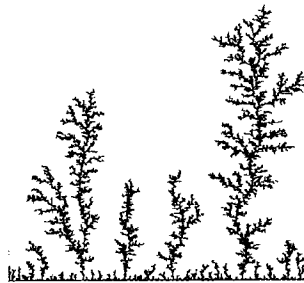

FIG. 32B

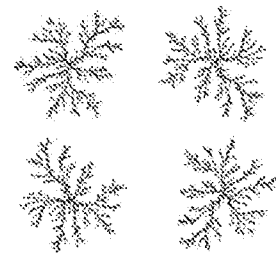

FIG. 32C



FIG. 33A

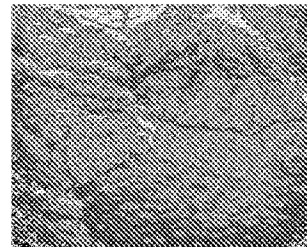

FIG. 33B

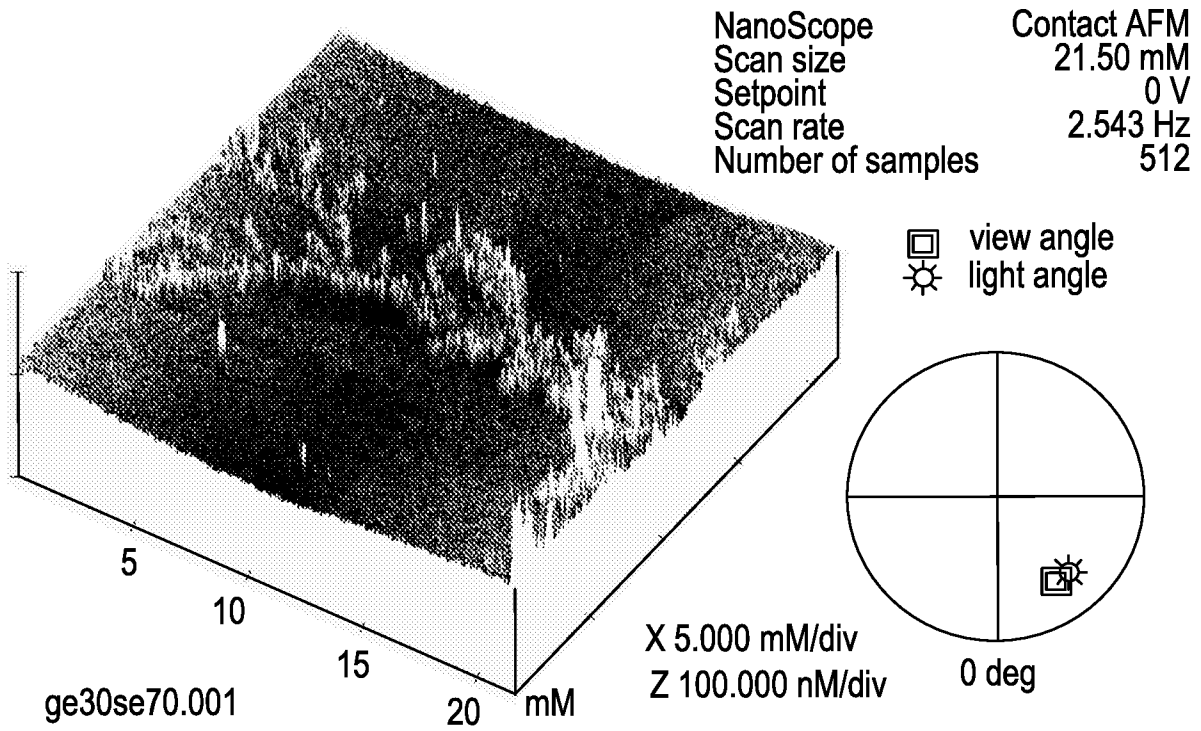

FIG. 34A

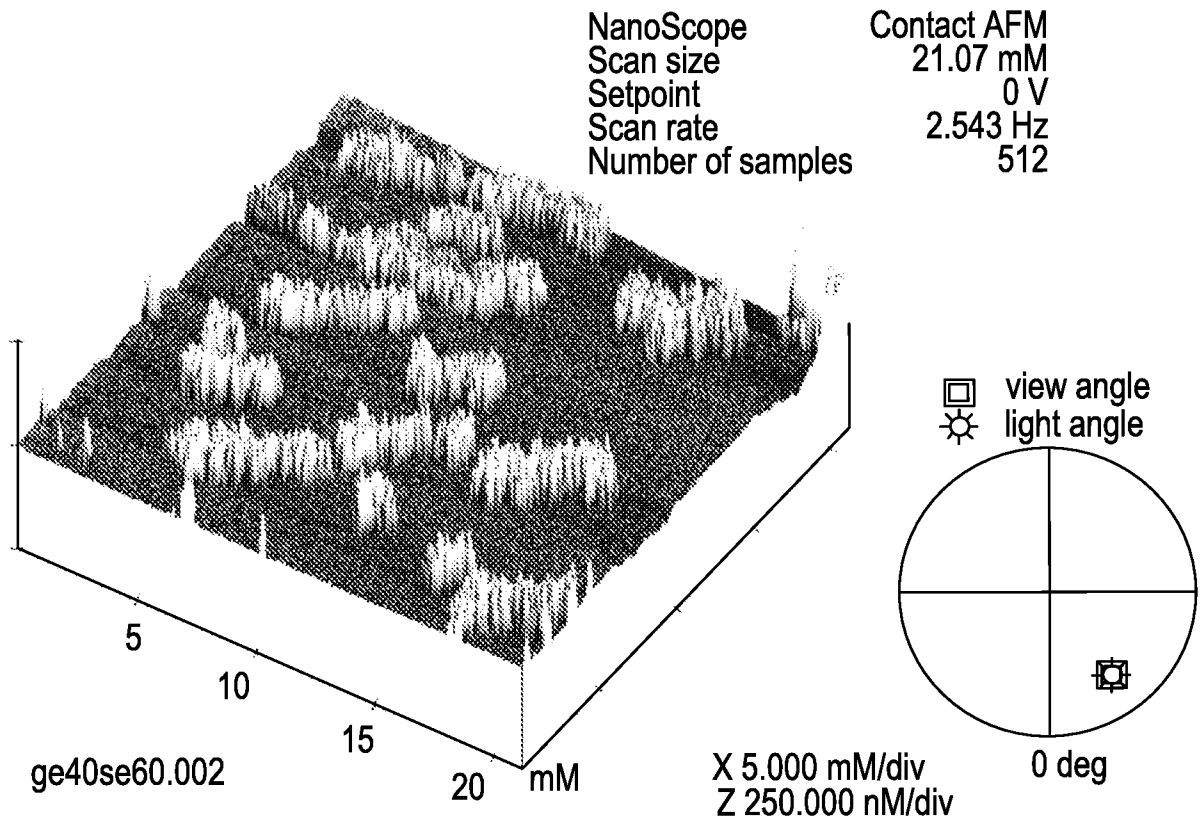

FIG. 34B

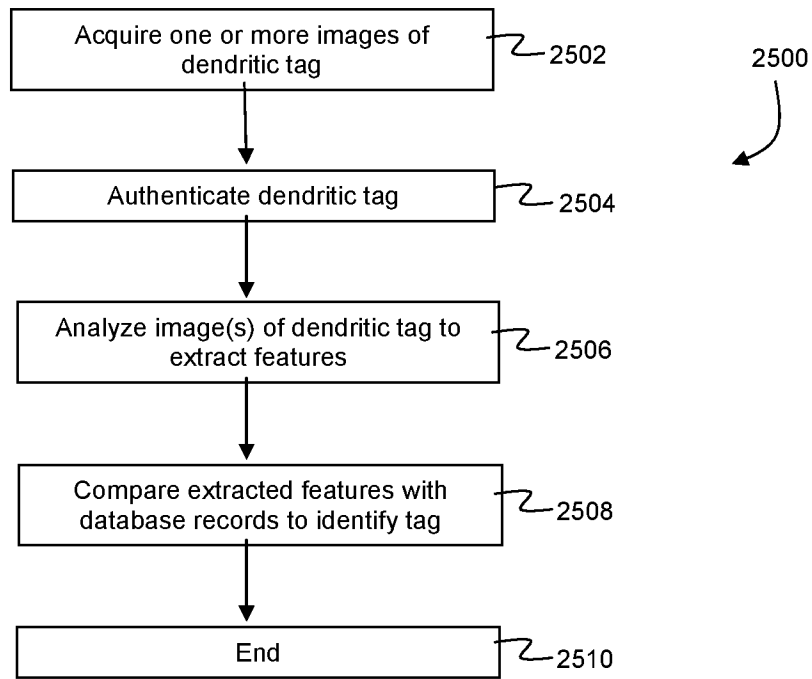

FIG. 35

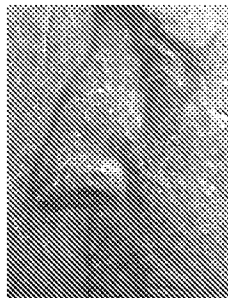

FIG. 36

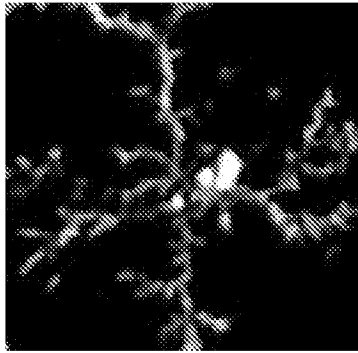

FIG. 37A

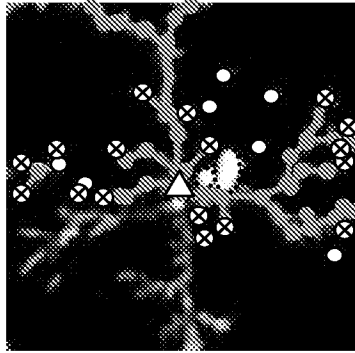

FIG. 37B

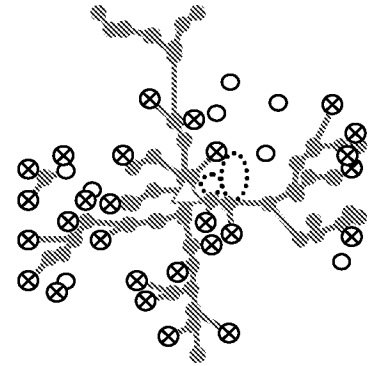

FIG. 37C

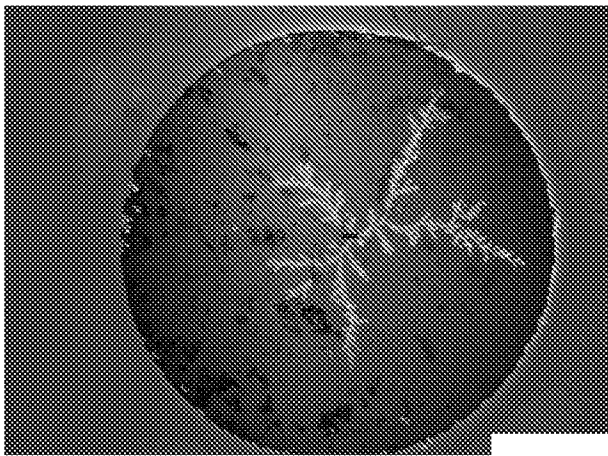

FIG. 38A

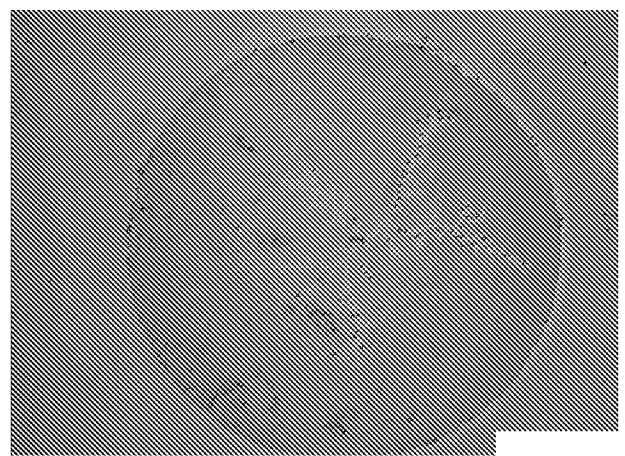

FIG. 38B

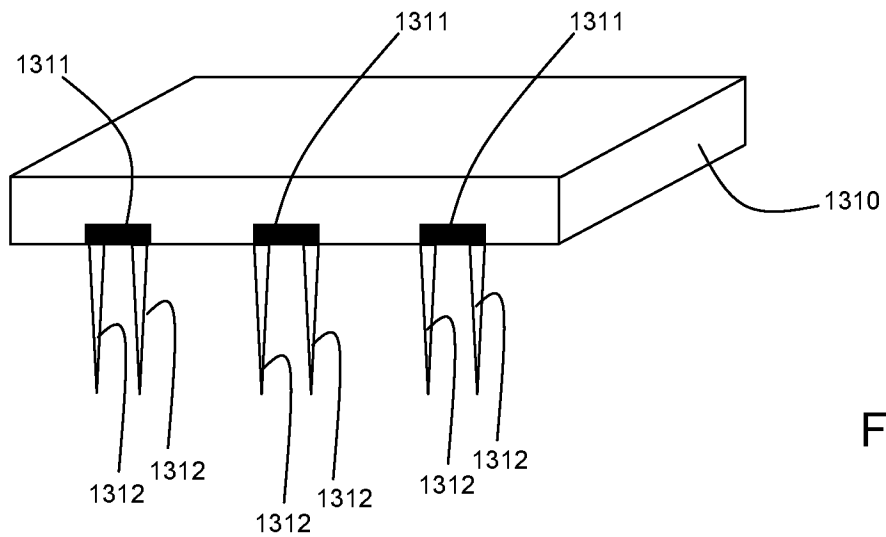

FIG. 39

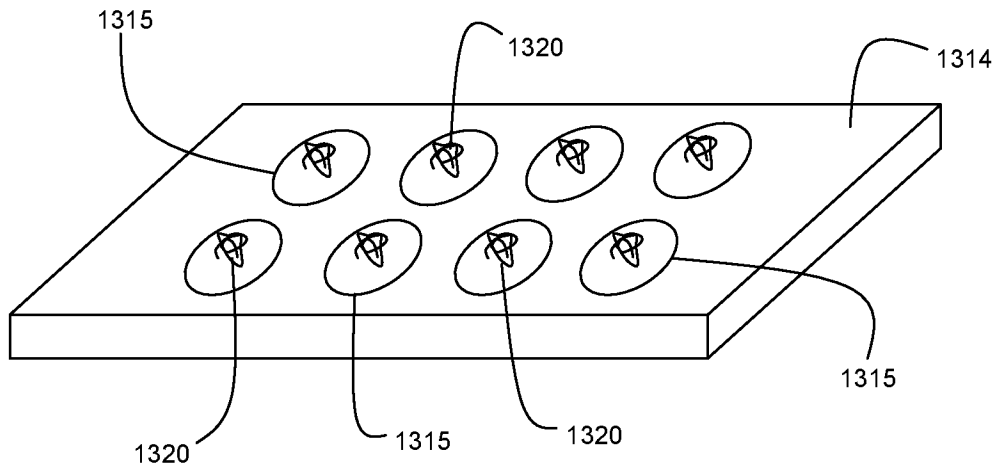

FIG. 40

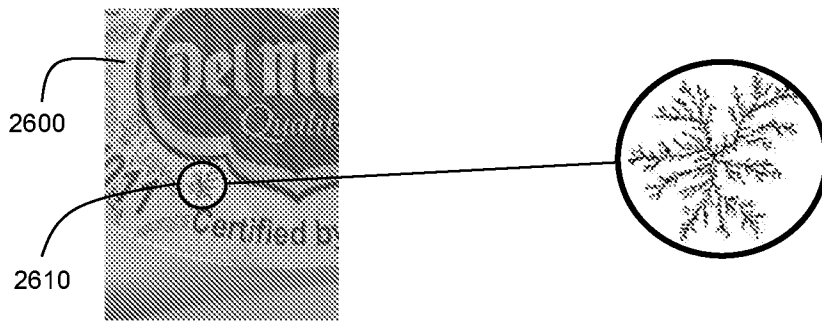

FIG. 41

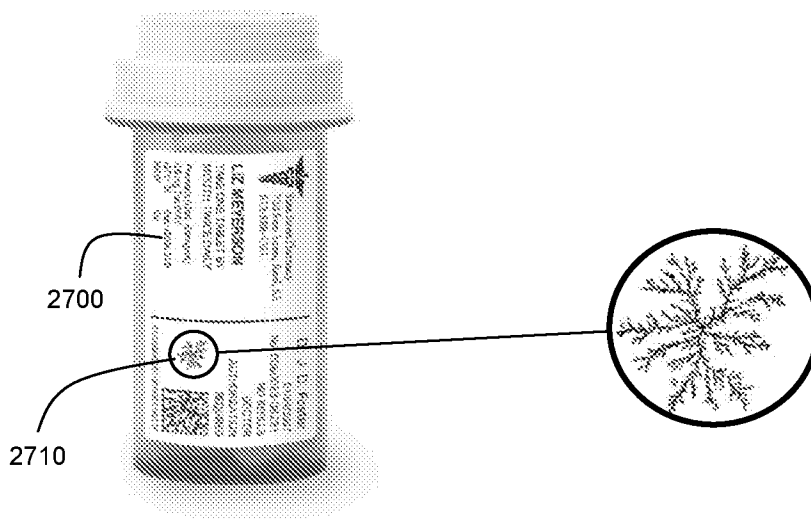

FIG. 42

21/36

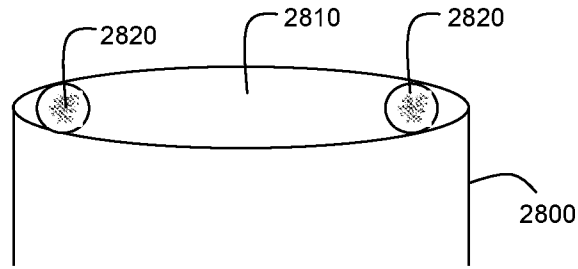

FIG. 43

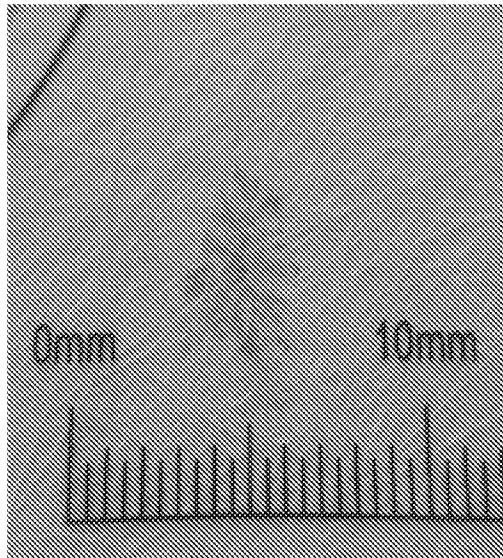

FIG. 44A

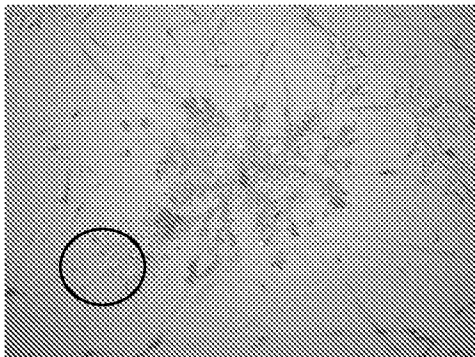

FIG. 44B

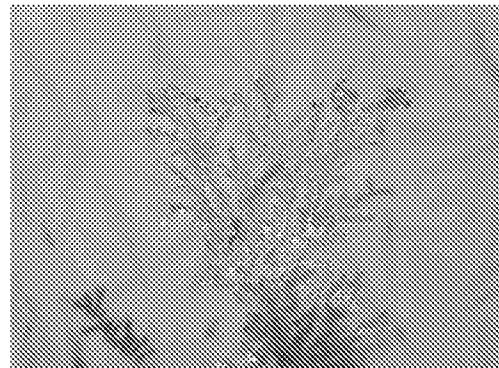

FIG. 44C

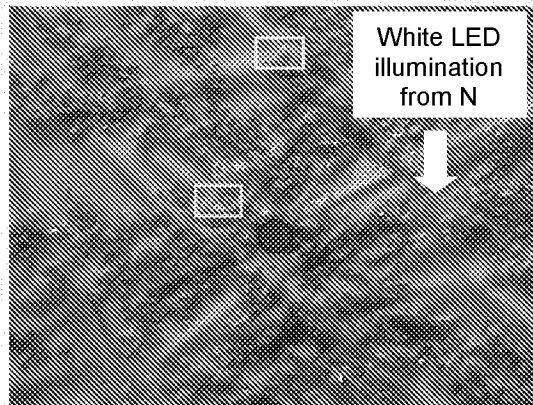

FIG. 45A

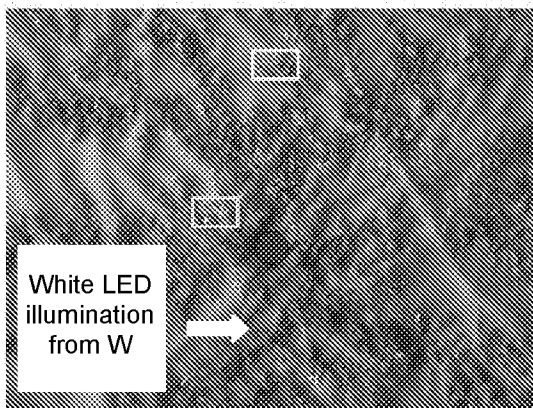

FIG. 45B

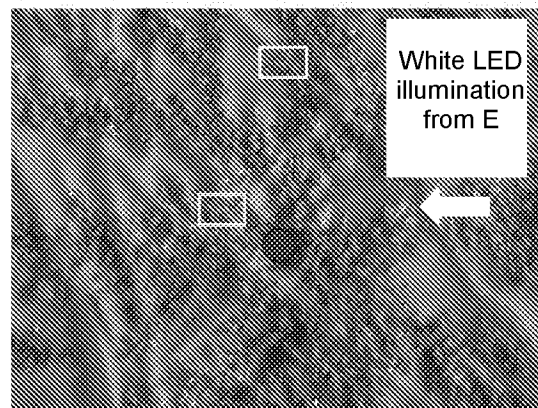

FIG. 45C

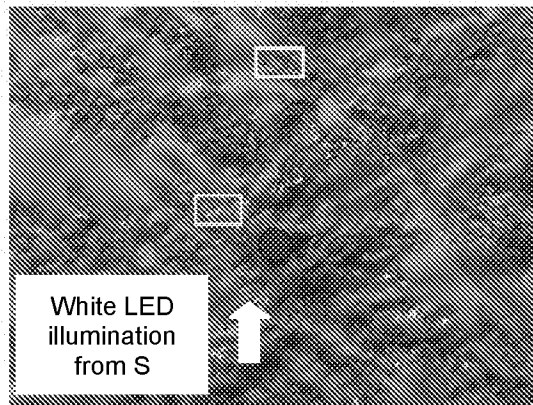

FIG. 45D

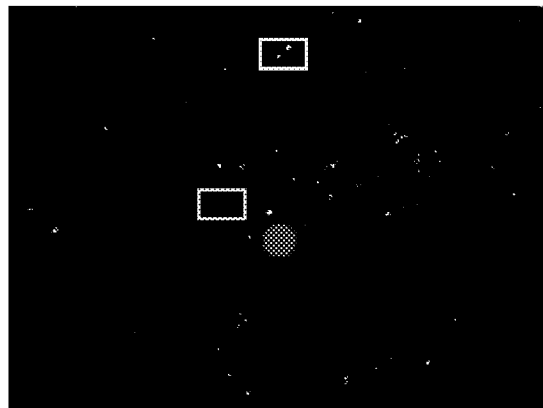

FIG. 46A

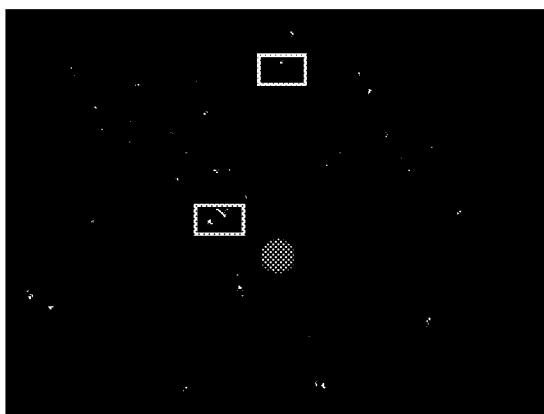

FIG. 46B

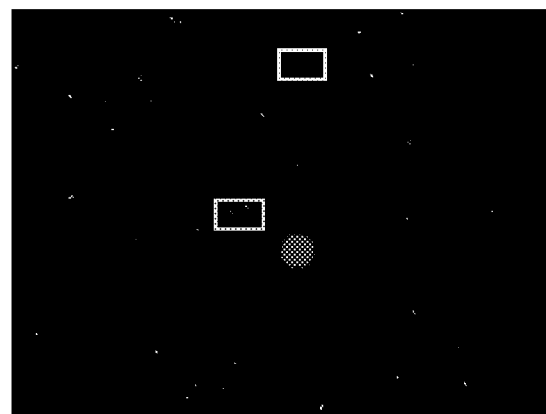

FIG. 46C

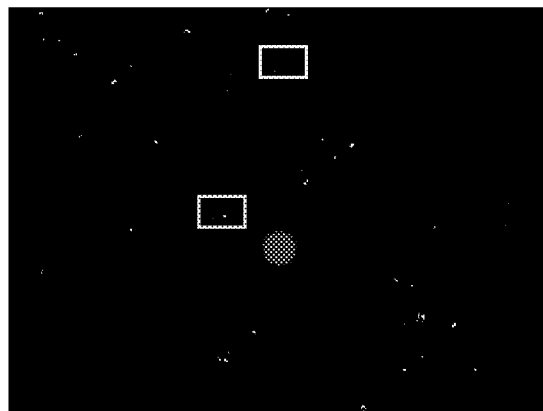

FIG. 46D

FIG. 47A

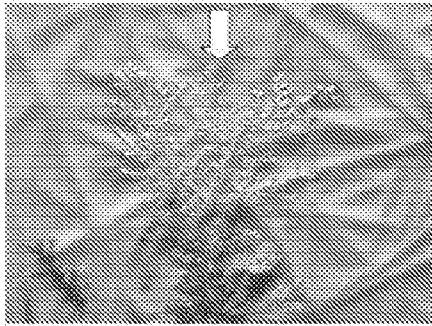

FIG. 47C

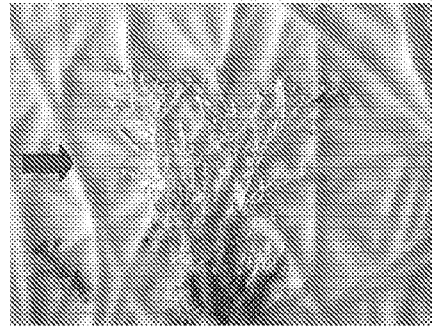

FIG. 47B

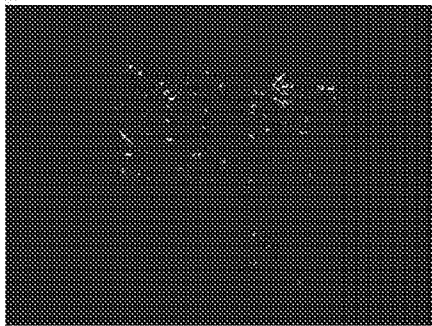

FIG. 47D

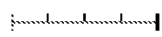
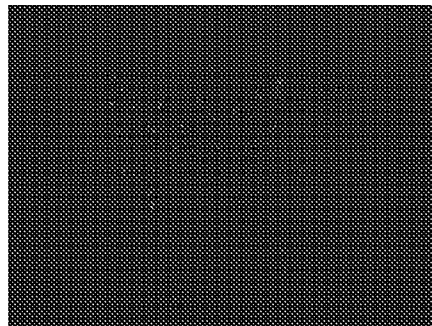

FIG. 48A

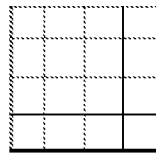

FIG. 48B

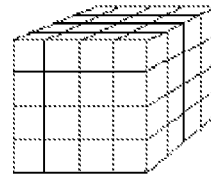

FIG. 48C

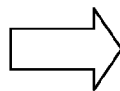

FIG. 49A

25/36

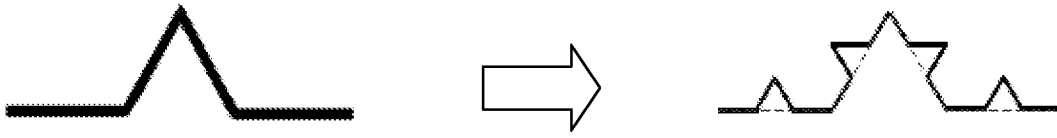

FIG. 49B

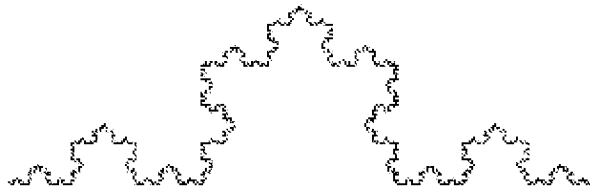

FIG. 49C

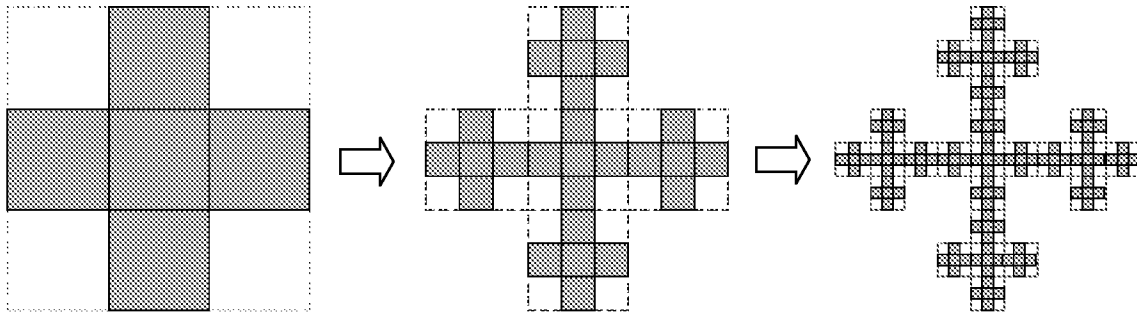

FIG. 50



FIG. 51

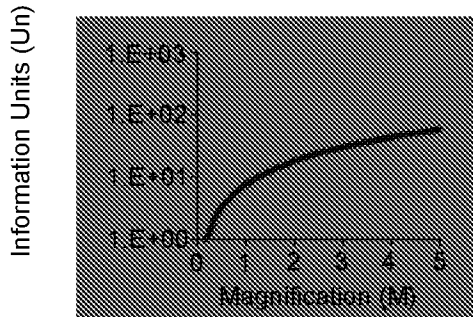

FIG. 52A

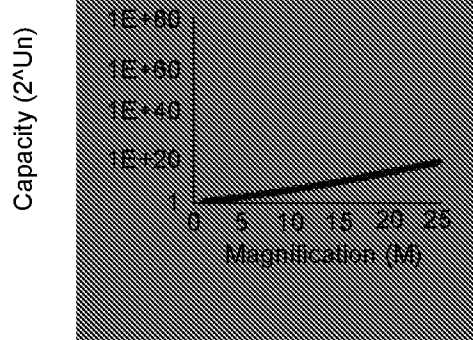

FIG. 52B

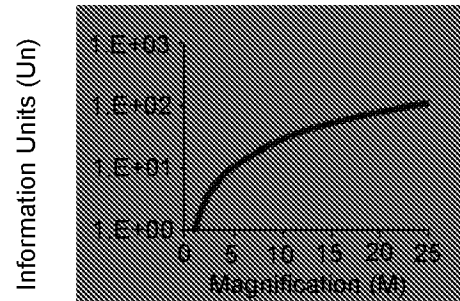

FIG. 52C

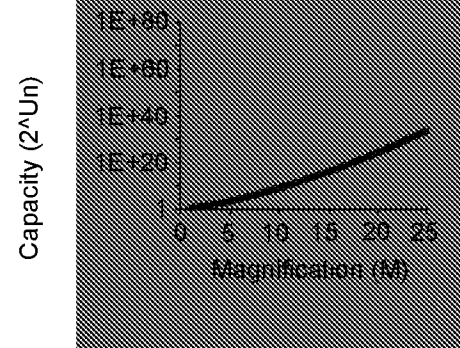

FIG. 52D

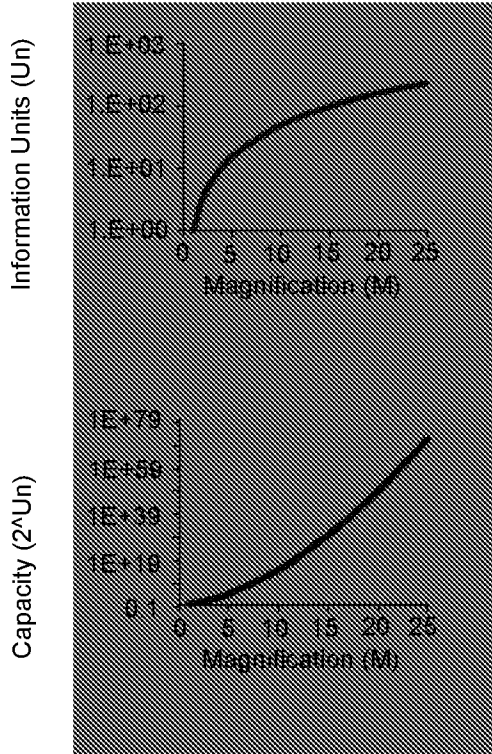

FIG. 52E

FIG. 52F

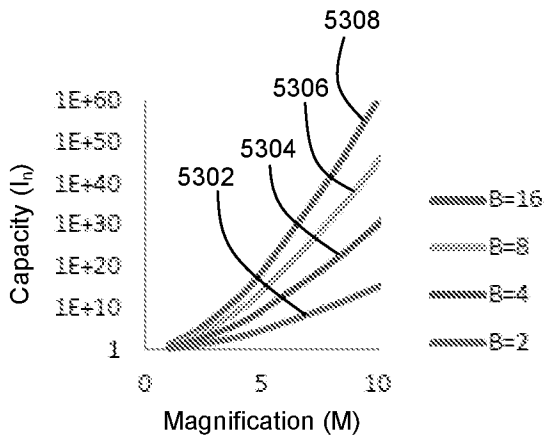

FIG. 53A

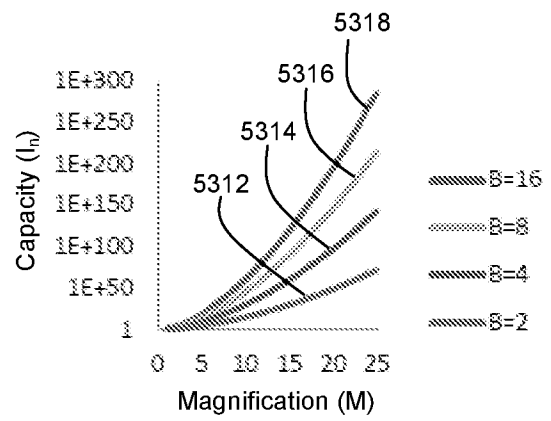

FIG. 53B

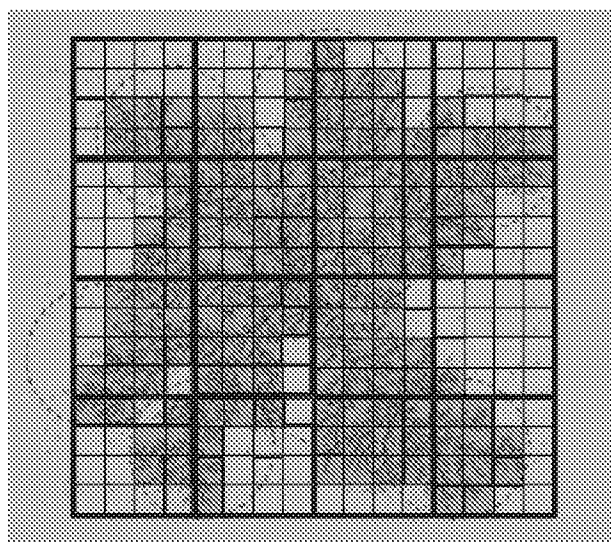
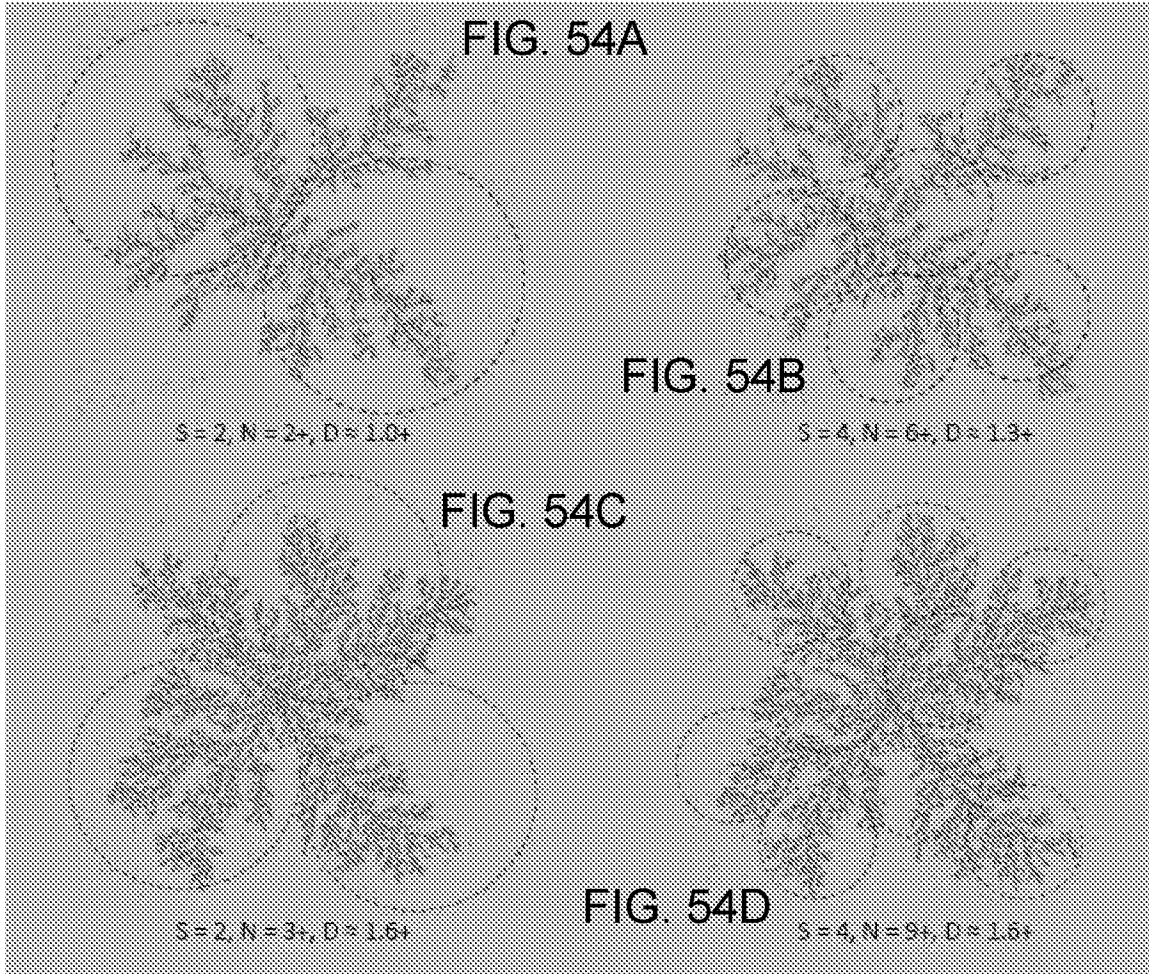

FIG. 55

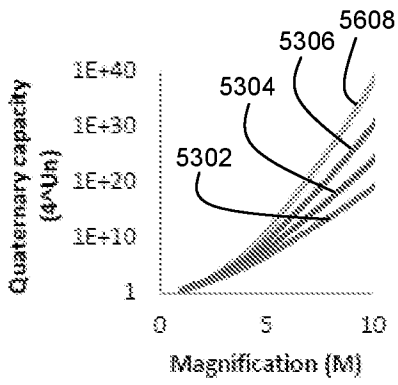

FIG. 56A

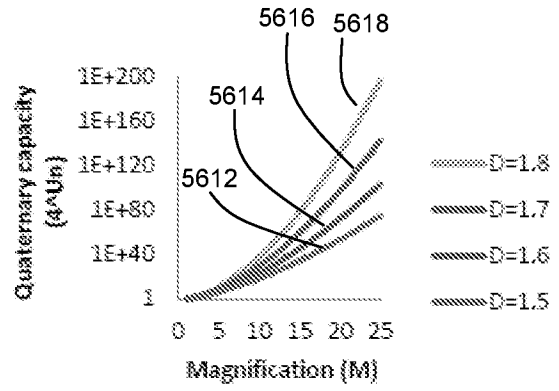

FIG. 56B

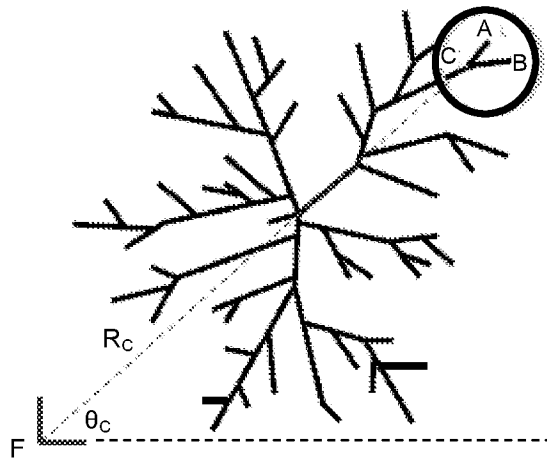

FIG. 57A

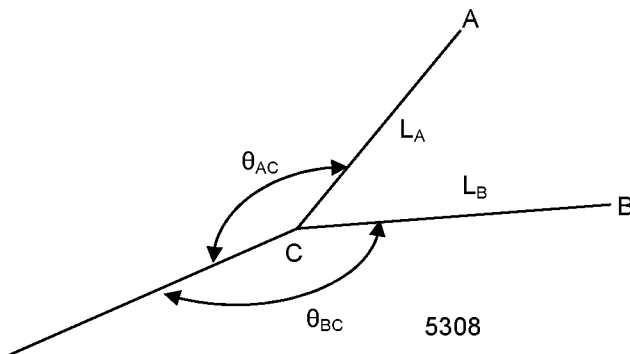

FIG. 57B

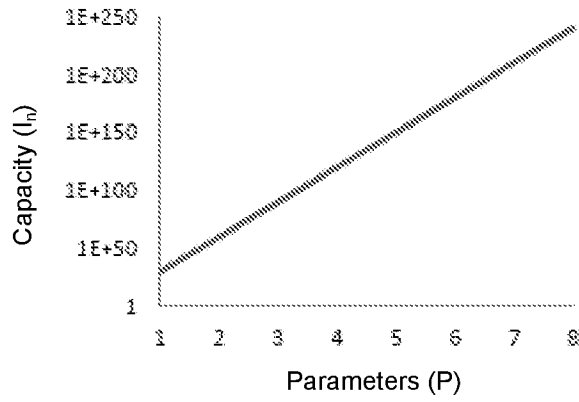

FIG. 58

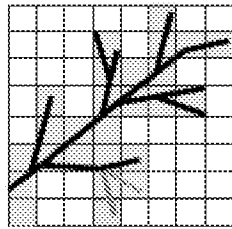

FIG. 59

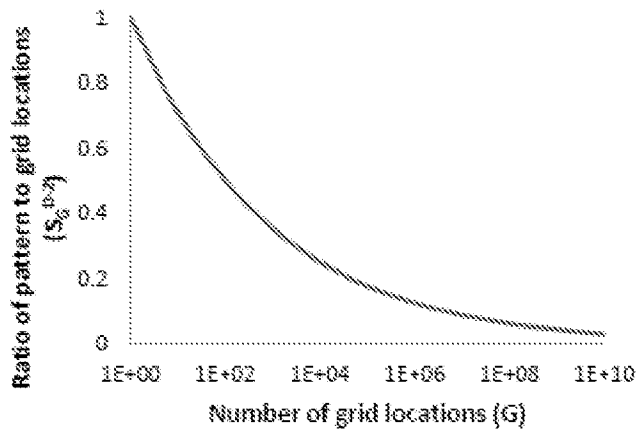

FIG. 60

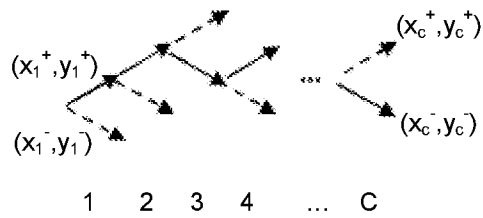

FIG. 61

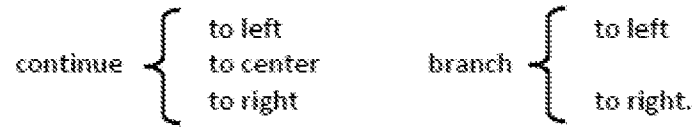

FIG. 62

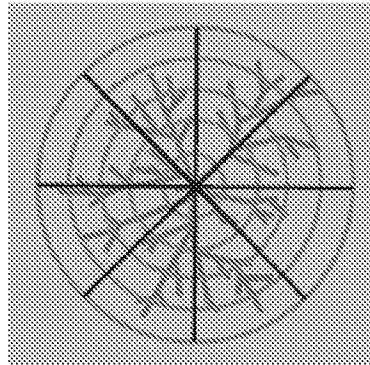

FIG. 63

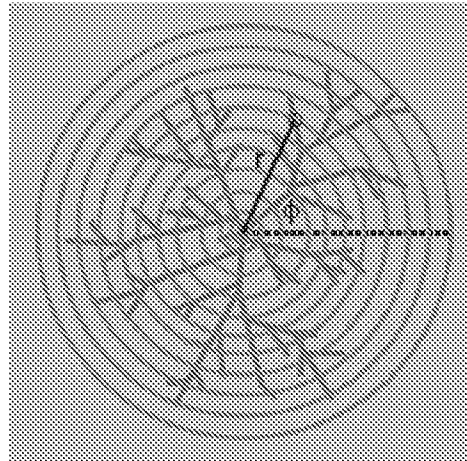

FIG. 64

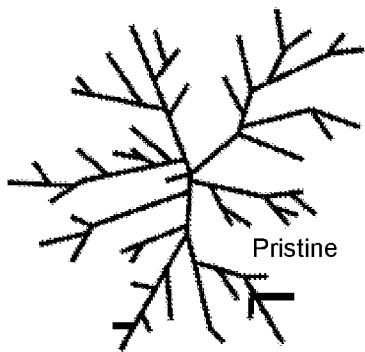

FIG. 65A

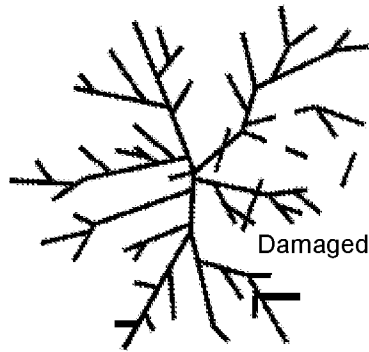

FIG. 65B

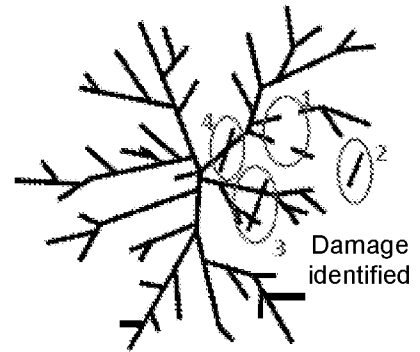

FIG. 65C

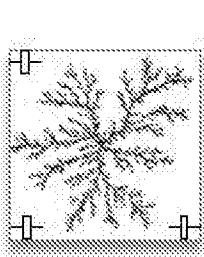

FIG. 66A

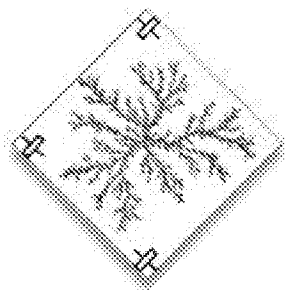

FIG. 66B

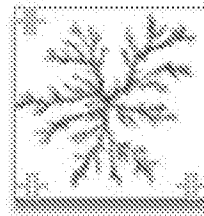

FIG. 66C

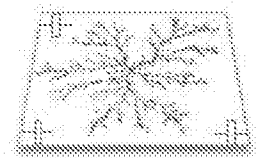

FIG. 66D

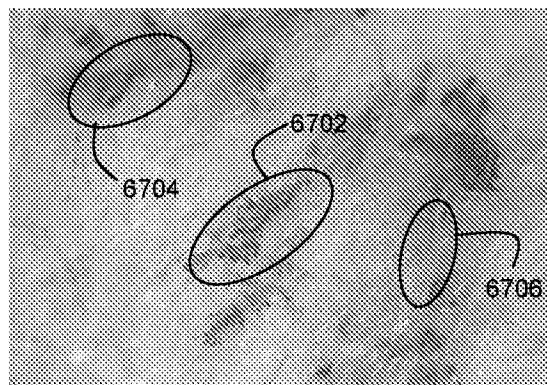

FIG. 67

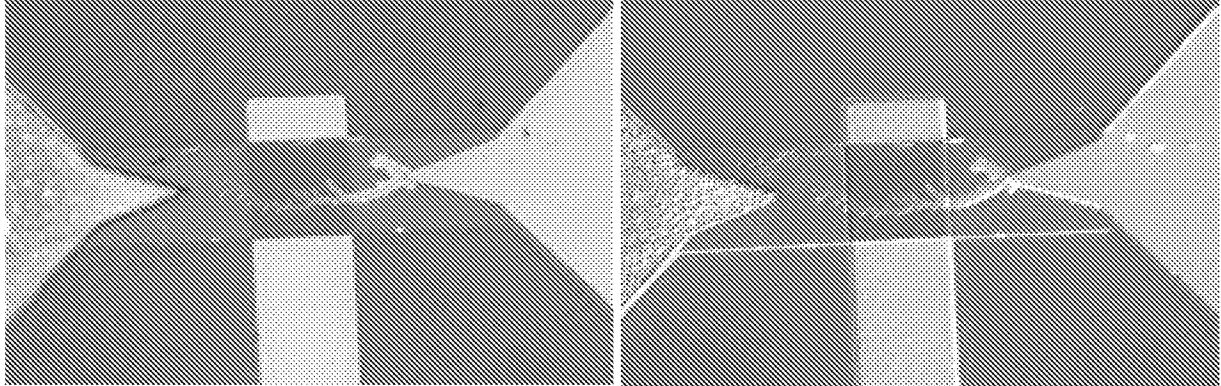

FIG. 68

FIG. 69

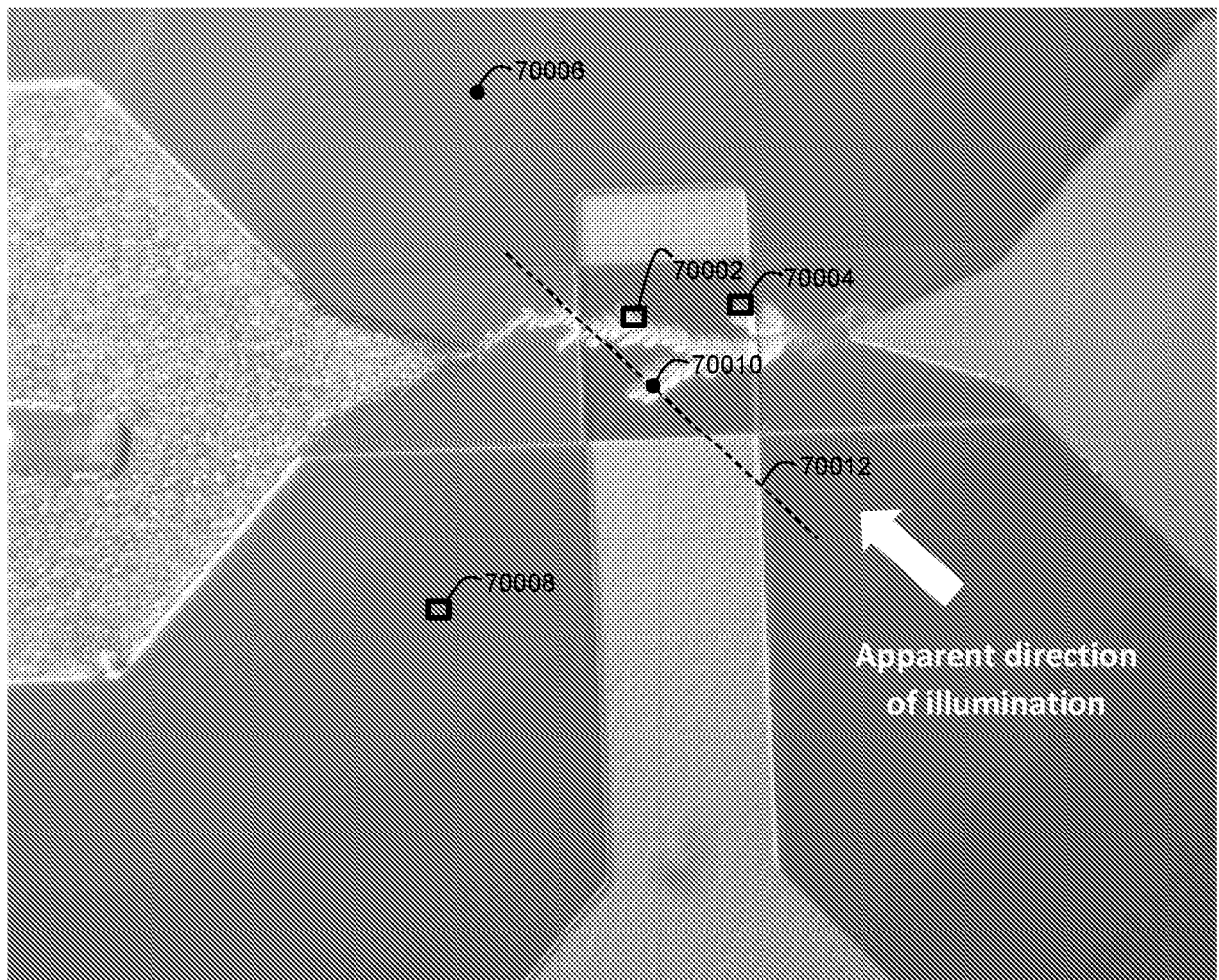

FIG. 70

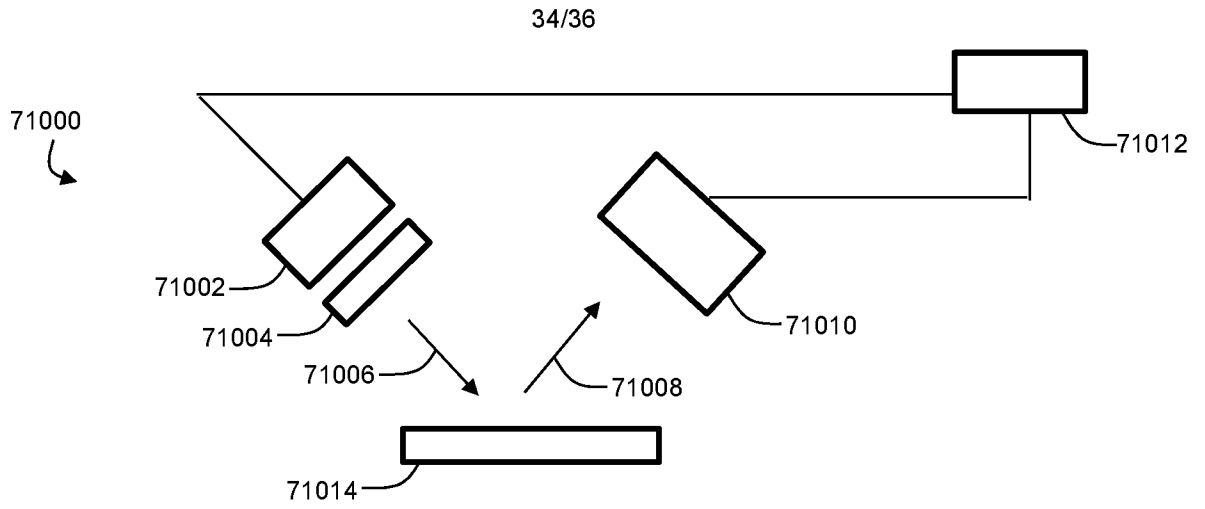

FIG. 71

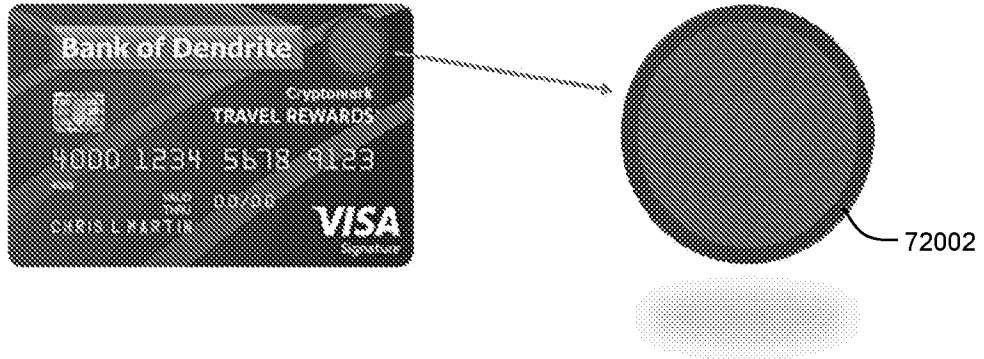

FIG. 72

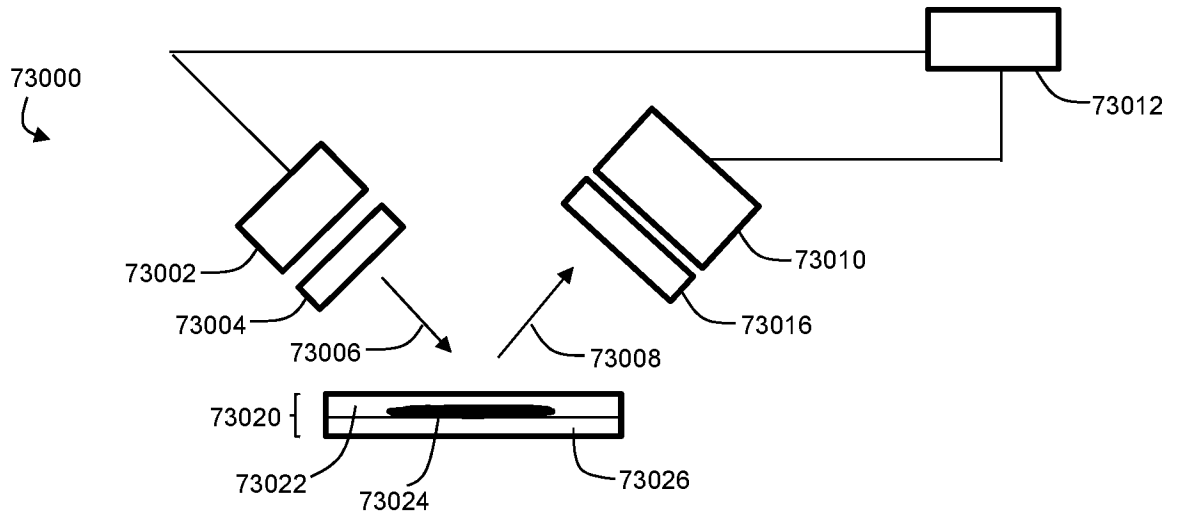

FIG. 73

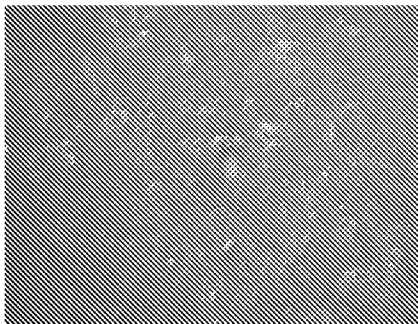

FIG. 74A

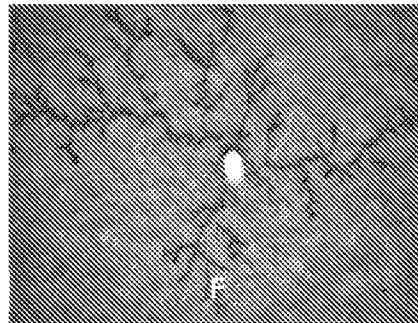

FIG. 74B

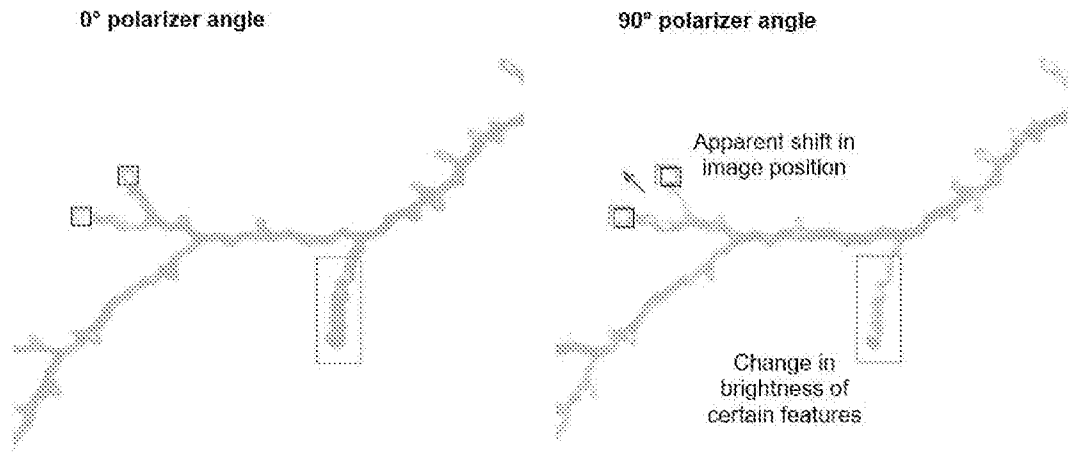

FIG. 75A

FIG. 75B

INTERNATIONAL SEARCH REPORT

International application No.  
PCT/US18/38087

<p>A. CLASSIFICATION OF SUBJECT MATTER                  IPC - G06K7/10, 9/46, G02B 21/365, H04L 9/32 (2018.01)                  CPC - G06K 9/00577, 7/1099, 9/6202, G02B 21/365, H04L 9/3278</p> <p>According to International Patent Classification (IPC) or to both national classification and IPC</p>														
<p>B. FIELDS SEARCHED</p> <p>Minimum documentation searched (classification system followed by classification symbols) See Search History document</p> <p>Documentation searched other than minimum documentation to the extent that such documents are included in the fields searched See Search History document</p> <p>Electronic data base consulted during the international search (name of data base and, where practicable, search terms used) See Search History document</p>														
<p>C. DOCUMENTS CONSIDERED TO BE RELEVANT</p> <table border="1"> <thead> <tr> <th>Category*</th> <th>Citation of document, with indication, where appropriate, of the relevant passages</th> <th>Relevant to claim No.</th> </tr> </thead> <tbody> <tr> <td>X</td> <td>PSILODIMITRAKOPOULOS, S. et al. "Quantitative Imaging of Microtubule Alteration as an Early Marker of Axonal Degeneration after Ischemia in Neurons". Biophysics Journal. March 2013; 104(5):968-75; &lt;DOI:10.1016/j.bpj.2013.01.020&gt; abstract; figures 1, 3, 4; ; page 968, paragraph 1; page 969, paragraphs 10- page 970, paragraph 1; page 970, paragraph 4- page 971, paragraph 2 ; page 971, paragraphs 8- page 972, paragraph 3.</td> <td>1-12</td> </tr> <tr> <td>A</td> <td>US 2016/0078617 A1 (KOZICKI, M) March 17, 2016; entire document.</td> <td>1-12</td> </tr> <tr> <td>A</td> <td>US 2007/0132998 A1 (TANG, C. et al.) June 14, 2007; entire document.</td> <td>1-12</td> </tr> </tbody> </table>			Category*	Citation of document, with indication, where appropriate, of the relevant passages	Relevant to claim No.	X	PSILODIMITRAKOPOULOS, S. et al. "Quantitative Imaging of Microtubule Alteration as an Early Marker of Axonal Degeneration after Ischemia in Neurons". Biophysics Journal. March 2013; 104(5):968-75; <DOI:10.1016/j.bpj.2013.01.020> abstract; figures 1, 3, 4; ; page 968, paragraph 1; page 969, paragraphs 10- page 970, paragraph 1; page 970, paragraph 4- page 971, paragraph 2 ; page 971, paragraphs 8- page 972, paragraph 3.	1-12	A	US 2016/0078617 A1 (KOZICKI, M) March 17, 2016; entire document.	1-12	A	US 2007/0132998 A1 (TANG, C. et al.) June 14, 2007; entire document.	1-12
Category*	Citation of document, with indication, where appropriate, of the relevant passages	Relevant to claim No.												
X	PSILODIMITRAKOPOULOS, S. et al. "Quantitative Imaging of Microtubule Alteration as an Early Marker of Axonal Degeneration after Ischemia in Neurons". Biophysics Journal. March 2013; 104(5):968-75; <DOI:10.1016/j.bpj.2013.01.020> abstract; figures 1, 3, 4; ; page 968, paragraph 1; page 969, paragraphs 10- page 970, paragraph 1; page 970, paragraph 4- page 971, paragraph 2 ; page 971, paragraphs 8- page 972, paragraph 3.	1-12												
A	US 2016/0078617 A1 (KOZICKI, M) March 17, 2016; entire document.	1-12												
A	US 2007/0132998 A1 (TANG, C. et al.) June 14, 2007; entire document.	1-12												
<p><input type="checkbox"/> Further documents are listed in the continuation of Box C.      <input type="checkbox"/> See patent family annex.</p>														
<p>* Special categories of cited documents:</p> <table> <tr> <td>"A" document defining the general state of the art which is not considered to be of particular relevance</td> <td>"T" later document published after the international filing date or priority date and not in conflict with the application but cited to understand the principle or theory underlying the invention</td> </tr> <tr> <td>"E" earlier application or patent but published on or after the international filing date</td> <td>"X" document of particular relevance; the claimed invention cannot be considered novel or cannot be considered to involve an inventive step when the document is taken alone</td> </tr> <tr> <td>"L" document which may throw doubts on priority claim(s) or which is cited to establish the publication date of another citation or other special reason (as specified)</td> <td>"Y" document of particular relevance; the claimed invention cannot be considered to involve an inventive step when the document is combined with one or more other such documents, such combination being obvious to a person skilled in the art</td> </tr> <tr> <td>"O" document referring to an oral disclosure, use, exhibition or other means</td> <td>"&amp;" document member of the same patent family</td> </tr> <tr> <td>"P" document published prior to the international filing date but later than the priority date claimed</td> <td></td> </tr> </table>			"A" document defining the general state of the art which is not considered to be of particular relevance	"T" later document published after the international filing date or priority date and not in conflict with the application but cited to understand the principle or theory underlying the invention	"E" earlier application or patent but published on or after the international filing date	"X" document of particular relevance; the claimed invention cannot be considered novel or cannot be considered to involve an inventive step when the document is taken alone	"L" document which may throw doubts on priority claim(s) or which is cited to establish the publication date of another citation or other special reason (as specified)	"Y" document of particular relevance; the claimed invention cannot be considered to involve an inventive step when the document is combined with one or more other such documents, such combination being obvious to a person skilled in the art	"O" document referring to an oral disclosure, use, exhibition or other means	"&" document member of the same patent family	"P" document published prior to the international filing date but later than the priority date claimed			
"A" document defining the general state of the art which is not considered to be of particular relevance	"T" later document published after the international filing date or priority date and not in conflict with the application but cited to understand the principle or theory underlying the invention													
"E" earlier application or patent but published on or after the international filing date	"X" document of particular relevance; the claimed invention cannot be considered novel or cannot be considered to involve an inventive step when the document is taken alone													
"L" document which may throw doubts on priority claim(s) or which is cited to establish the publication date of another citation or other special reason (as specified)	"Y" document of particular relevance; the claimed invention cannot be considered to involve an inventive step when the document is combined with one or more other such documents, such combination being obvious to a person skilled in the art													
"O" document referring to an oral disclosure, use, exhibition or other means	"&" document member of the same patent family													
"P" document published prior to the international filing date but later than the priority date claimed														
<p>Date of the actual completion of the international search 21 August 2018 (21.08.2018)</p>		<p>Date of mailing of the international search report <b>18 OCT 2018</b></p>												
<p>Name and mailing address of the ISA/ Mail Stop PCT, Attn: ISA/US, Commissioner for Patents P.O. Box 1450, Alexandria, Virginia 22313-1450 Facsimile No. 571-273-8300</p>		<p>Authorized officer Shane Thomas  PCT Helpdesk: 571-272-4300 PCT OSP: 571-272-7774</p>												

INTERNATIONAL SEARCH REPORT

International application No.

PCT/US18/38087

**Box No. II Observations where certain claims were found unsearchable (Continuation of item 2 of first sheet)**

This international search report has not been established in respect of certain claims under Article 17(2)(a) for the following reasons:

1.  Claims Nos.:  
because they relate to subject matter not required to be searched by this Authority, namely:
  
2.  Claims Nos.:  
because they relate to parts of the international application that do not comply with the prescribed requirements to such an extent that no meaningful international search can be carried out, specifically:
  
3.  Claims Nos.:  
because they are dependent claims and are not drafted in accordance with the second and third sentences of Rule 6.4(a).

**Box No. III Observations where unity of invention is lacking (Continuation of item 3 of first sheet)**

This International Searching Authority found multiple inventions in this international application, as follows:  
SEE EXTRA SHEET

1.  As all required additional search fees were timely paid by the applicant, this international search report covers all searchable claims.
2.  As all searchable claims could be searched without effort justifying additional fees, this Authority did not invite payment of additional fees.
3.  As only some of the required additional search fees were timely paid by the applicant, this international search report covers only those claims for which fees were paid, specifically claims Nos.:
4.  No required additional search fees were timely paid by the applicant. Consequently, this international search report is restricted to the invention first mentioned in the claims; it is covered by claims Nos.:  
Claims 1-12

- Remark on Protest**
- The additional search fees were accompanied by the applicant's protest and, where applicable, the payment of a protest fee.
  - The additional search fees were accompanied by the applicant's protest but the applicable protest fee was not paid within the time limit specified in the invitation.
  - No protest accompanied the payment of additional search fees.

\*\*\*-Continued from Box No. III Observations where unity of invention is lacking -\*\*\*-

This application contains the following inventions or groups of inventions which are not so linked as to form a single general inventive concept under PCT Rule 13.1. In order for all inventions to be examined, the appropriate additional examination fee must be paid.

Group I: Claims 1-12 are directed towards identifying dendritic structures using a pair of images with different polarizations of light emitted on the structure.

Group II: Claims 13-25 are directed towards identifying dendritic structures using a single polarization of light and using a polarizer to analyze light refracted from the structure .

The inventions listed as Groups I-II do not relate to a single general inventive concept under PCT Rule 13.1 because, under PCT Rule 13.2, they lack the same or corresponding special technical features for the following reasons:

The special technical features of Group I include at least illuminating the candidate structure with radiation linearly polarized along a second polarization direction and obtaining a second image of the dendritic structure, wherein an angle between the first and second polarization directions is at least 10°; for a set of pixels corresponding to a first region of the candidate structure in the first and second images, determining a first change in average pixel intensity between the first and second images; and authenticating the candidate structure as a dendritic structure based on the first change in average pixel intensity, which are not present in Group II.

The special technical features of Group II include at least wherein the illuminating radiation passes through a light diffusing coating directing radiation reflected from the dendritic structure to pass through a polarizing element to generate measurement radiation linearly polarized along a second polarization direction; extracting information from the dendritic identifier based on one or more structural features of the dendritic structure determined from the image; and wherein a minimum angle between the first and second polarization directions is at least 80°, which are not present in Group I.

The common technical features shared by Groups I-II are illuminating a candidate structure with radiation linearly polarized along a first polarization direction, reflecting light from a dendritic structure, and measuring the light to obtain an image of the dendritic structure.

However, these common features are previously disclosed by "Quantitative Imaging of Microtubule Alteration as an Early Marker of Axonal Degeneration after Ischemia in Neurons" by Psilodimitrakopoulos, S. et al. (hereinafter "Psilodimitrakopoulos"). Psilodimitrakopoulos discloses illuminating a candidate structure with radiation linearly polarized along a first polarization direction (microtubules (dendritic structures) are imaged using a laser scanning inverted microscope via a linear polarizer on a motorized rotatable stage at 9 steps of 20 degrees each; figure 1; page 968, paragraph 1; page 969, paragraphs 10- page 970, paragraph 1), reflecting light from a dendritic structure (microtubules (dendritic structures) are imaged using a laser scanning inverted microscope to image the reflected light off the microtubules; figures 1 and 2; page 969, paragraphs 10- page 970, paragraph 1; page 971, paragraphs 8), and measuring the light to obtain an image of the dendritic structure (microtubules (dendritic structures) are imaged using a laser scanning inverted microscope via a linear polarizer on a motorized rotatable stage at 9 steps of 20 degrees each; figures 1 and 2; page 969, paragraphs 10- page 970, paragraph 1; page 971, paragraphs 8).

Since the common technical features are previously disclosed by the Psilodimitrakopoulos reference, these common features are not special and so Groups I-II lack unity.