



US00D431925S

# United States Patent [19]

[11] Patent Number: Des. 431,925

Natuzzi et al.

[45] Date of Patent: \*\* Oct. 17, 2000

[54] SEAT

[75] Inventors: Pasquale Natuzzi; Domenico Abbruzzese, both of Bari, Italy

[73] Assignee: Industrie Natuzzi, SpA, Bari, Italy

[\*\*] Term: 14 Years

[21] Appl. No.: 29/111,712

[22] Filed: Oct. 1, 1999

[51] LOC (7) Cl. .... 06-01

[52] U.S. Cl. .... D6/381; D6/334

[58] Field of Search ..... D6/334, 335, 336, D6/364, 371, 373, 381, 500, 501, 502; 5/12.1; 297/232, 445.1

### [56] References Cited

#### U.S. PATENT DOCUMENTS

D. 382,130	8/1997	Natuzzi et al. ....	D6/381
D. 407,229	3/1999	Riboldi .....	D6/381
D. 420,525	2/2000	Watson .....	D6/381
D. 424,318	5/2000	Natuzzi et al. ....	D6/381

#### OTHER PUBLICATIONS

Furniture Today, p. 49, Calia Salotti sofa at bottom, Apr. 27, 1998.

Natuzzi Model 417, Oct. 1987, at International Home Furnishings Market in High Point, North Carolina.

Natuzzi Model 463, Oct. 1988, at International Home Furnishings Market in High Point, North Carolina.

Natuzzi Model 465, Oct. 1988, at International Home Furnishings Market in High Point, North Carolina.

Natuzzi Model 621, Oct. 1988, at International Home Furnishings Market in High Point, North Carolina.

Natuzzi Model 721, Oct. 1989, at International Home Furnishings Market in High Point, North Carolina.

Natuzzi Model 756, Apr. 1990, at International Home Furnishings Market in High Point, North Carolina.

Natuzzi Model 808, Oct. 1990, at International Home Furnishings Market in High Point, North Carolina.

Natuzzi Model 906, Apr. 1992, at International Home Furnishings Market in High Point, North Carolina.

Natuzzi Model 920, Apr. 1992, at International Home Furnishings Market in High Point, North Carolina.

Natuzzi Model 1536, Oct. 1996, at International Home Furnishings Market in High Point, North Carolina.

Natuzzi Model 1548, at least as early as Apr. 1997, at International Home Furnishings Market in High Point, North Carolina.

(List continued on next page.)

Primary Examiner—Gary D. Watson

Attorney, Agent, or Firm—Alston & Bird LLP

### [57] CLAIM

The ornamental design for a seat, as shown and described.

### DESCRIPTION

FIG. 1 is a front perspective view of a seat showing our new design in the form of a sofa;

FIG. 2 is a front elevational view thereof;

FIG. 3 is a top plan view thereof;

FIG. 4 is a right side elevational view, the left side being a mirror image thereof;

FIG. 5 is a rear perspective view thereof;

FIG. 6 is a front elevational view of a seat showing our new design in the form of a loveseat; and,

FIG. 7 is a front elevational view of a seat showing our new design in the form of a chair.

The broken lines shown herein are for illustrative purposes only and form no part of the claimed design.

The rear views of FIGS. 6 and 7 are like FIG. 5, the difference being a matter of length.

The end views of FIGS. 6 and 7 are like FIG. 4.

FIG. 1 is shown on an enlarged scale and FIGS. 4, 5 and 6 are shown on a reduced scale with respect to the other views.

1 Claim, 3 Drawing Sheets

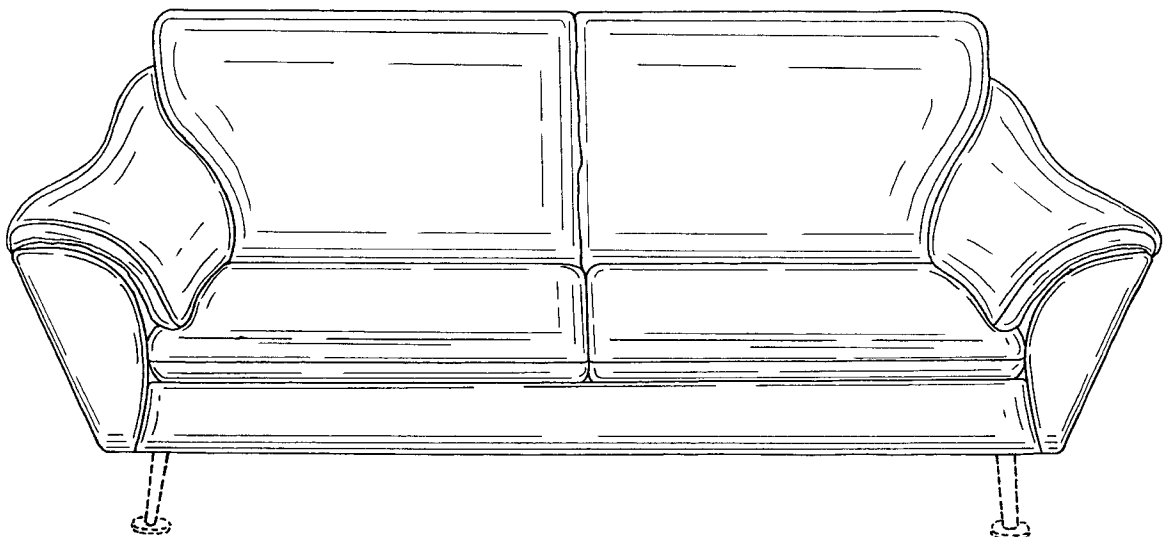

OTHER PUBLICATIONS

Natuzzi Model 1579, Apr. 1997, at International Home Furnishings Market in High Point, North Carolina.  
Natuzzi Model 1587, Apr. 1997, at International Home Furnishings Market in High Point, North Carolina.  
Natuzzi Model 1613, Apr. 1997, at International Home Furnishings Market in High Point, North Carolina.  
Natuzzi Model 1616, Apr. 1997, at International Home Furnishings Market in High Point, North Carolina.  
Natuzzi Model 1628, Oct. 1997, at International Home Furnishings Market in High Point, North Carolina.

Natuzzi Model 1641, Oct. 1997, at International Home Furnishings Market in High Point, North Carolina.

Natuzzi Model 1665, Apr. 1998, at International Home Furnishings Market in High Point, North Carolina.

Natuzzi Model 1689, Apr. 1998, at International Home Furnishings Market in High Point, North Carolina.

Natuzzi Model 1690, Apr. 1998, at International Home Furnishings Market in High Point, North Carolina.

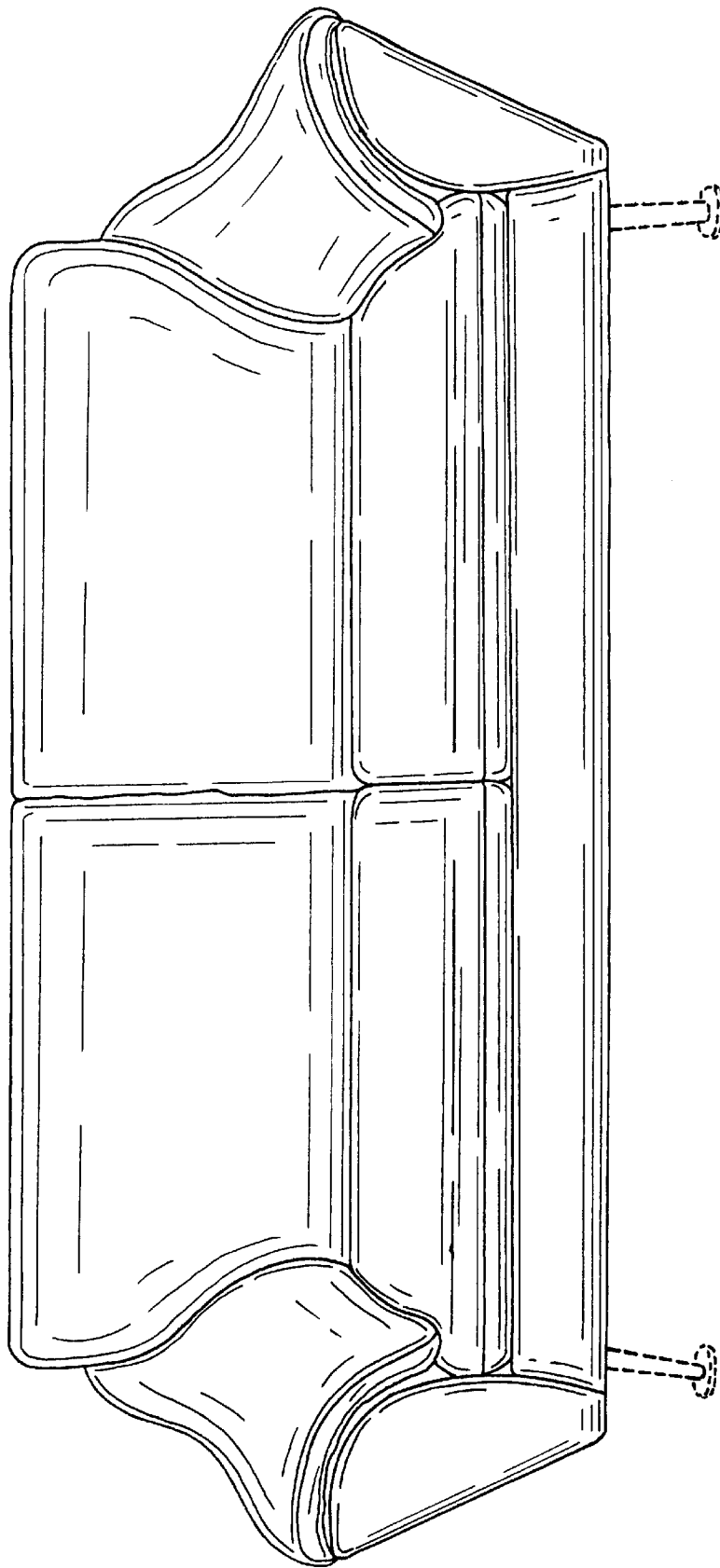

FIG. 1.

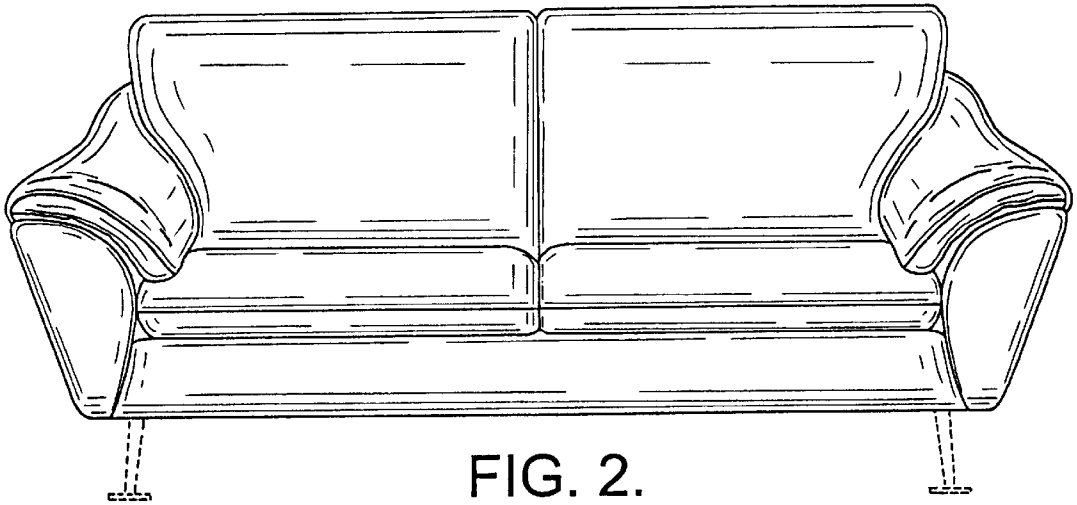

FIG. 2.

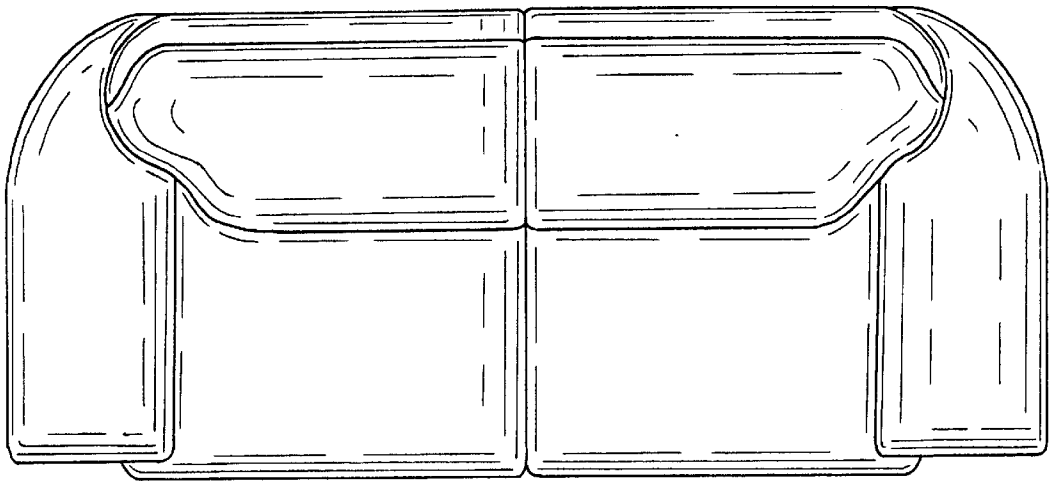

FIG. 3.

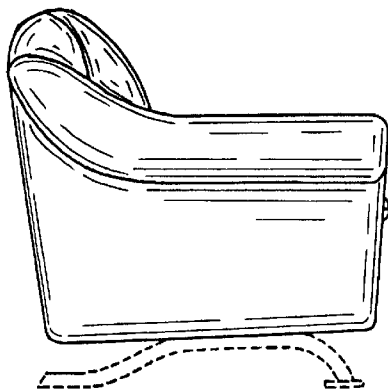

FIG. 4.

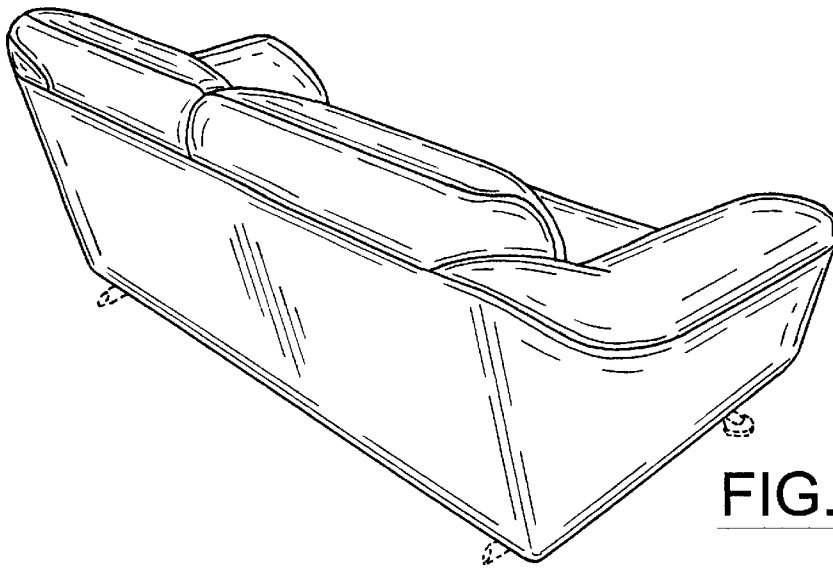

FIG. 5.

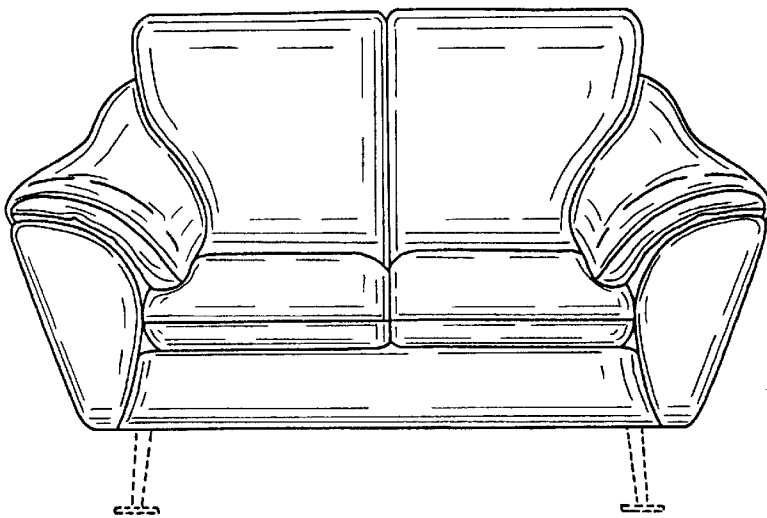

FIG. 6.

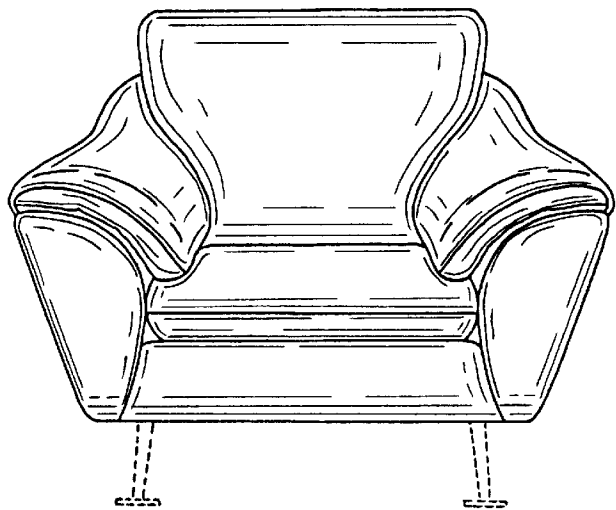

FIG. 7.