



(43) International Publication Date
24 September 2015 (24.09.2015)

- (51) International Patent Classification:
A61F 15/00 (2006.01) *A45C 11/00* (2006.01)
- (21) International Application Number:
PCT/HR2014/000013
- (22) International Filing Date:
17 March 2014 (17.03.2014)
- (25) Filing Language: English
- (26) Publication Language: English
- (72) Inventor; and
- (71) Applicant : **KVASTEK, Sanja** [HR/HR]; Radiceva 18,
HR-31500 Nasice (HR).
- (74) Agent: **BOŠKOVIĆ, Davor**; Producta d.o.o., Zinke Kunc
3a, HR-1000 Zagreb (HR).
- (81) Designated States (*unless otherwise indicated, for every
kind of national protection available*): AE, AG, AL, AM,
AO, AT, AU, AZ, BA, BB, BG, BH, BN, BR, BW, BY,
BZ, CA, CH, CL, CN, CO, CR, CU, CZ, DE, DK, DM,
DO, DZ, EC, EE, EG, ES, FI, GB, GD, GE, GH, GM, GT,
HN, HR, HU, ID, IL, IN, IR, IS, JP, KE, KG, KN, KP, KR,

KZ, LA, LC, LK, LR, LS, LT, LU, LY, MA, MD, ME,
MG, MK, MN, MW, MX, MY, MZ, NA, NG, NI, NO, NZ,
OM, PA, PE, PG, PH, PL, PT, QA, RO, RS, RU, RW, SA,
SC, SD, SE, SG, SK, SL, SM, ST, SV, SY, TH, TJ, TM,
TN, TR, TT, TZ, UA, UG, US, UZ, VC, VN, ZA, ZM,
ZW.

- (84) Designated States (*unless otherwise indicated, for every
kind of regional protection available*): ARIPO (BW, GH,
GM, KE, LR, LS, MW, MZ, NA, RW, SD, SL, SZ, TZ,
UG, ZM, ZW), Eurasian (AM, AZ, BY, KG, KZ, RU, TJ,
TM), European (AL, AT, BE, BG, CH, CY, CZ, DE, DK,
EE, ES, FI, FR, GB, GR, HR, HU, IE, IS, IT, LT, LU, LV,
MC, MK, MT, NL, NO, PL, PT, RO, RS, SE, SI, SK, SM,
TR), OAPI (BF, BJ, CF, CG, CI, CM, GA, GN, GQ, GW,
KM, ML, MR, NE, SN, TD, TG).

Declarations under Rule 4.17:

- of inventorship (Rule 4.17(iv))

Published:

- with international search report (Art. 21(3))

(54) Title: MULTIPURPOSE CONTAINER FOR SANITARY PRODUCTS

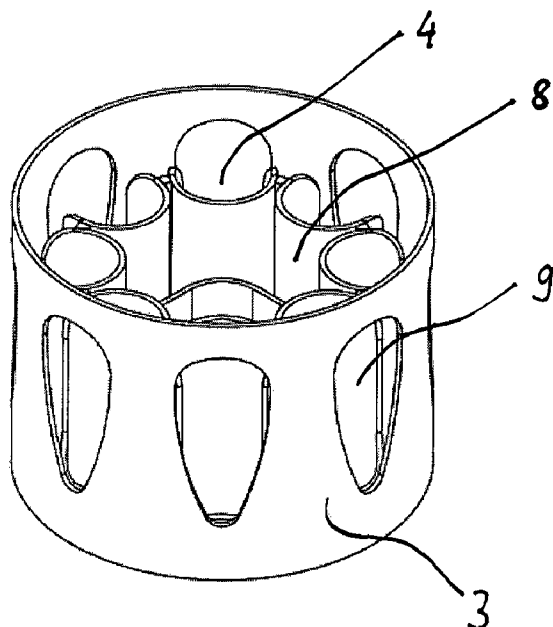

Fig. 2a

(57) Abstract: This invention refers to a multipurpose container for feminine hygiene products that has separated compartments intended to store various sanitary products, including sanitary tampons, protective finger covers, and bags for the disposal of used tampons. The multipurpose container for sanitary products has a two-part housing that consists of an interior container (1) and lid (2), which with its side wall tightly overlies the container's exterior wall (3). The interior container (1) has at least two separate tampon compartments (4), a central compartment (5) intended to store protective finger covers (6), and a lower lid (11) that has a compartment on its inside intended for the storage of bags for the disposal of used tampons.



MULTIPURPOSE CONTAINER FOR SANITARY PRODUCTS

DESCRIPTION OF THE INVENTION

The field pertaining to the invention

This invention refers to a container for feminine hygiene products that has separate compartments intended for different sanitary products, including sanitary tampons, protective finger covers, tampon disposal bags, etc. and is classified as A45C 11/00 – receptacles for purposes not provided for in groups according to the international patent classification (IPC).

Technical problem

In order to protect themselves from potential bacteria during their menstrual periods, women use a protective finger cover when inserting a feminine hygiene tampon product into the vagina. Since women usually carry feminine hygiene tampon products outside of their home in various containers, the need has arisen for a container that would have a separately enclosed compartment for feminine hygiene tampon products, and further an additional separate compartment for protective finger covers, to enable a more practical use of both sanitary products. Furthermore, the use of such a finger cover enables significantly greater hygiene during insertion of a tampon into the vagina, and as a result, decreases the possibility of various bacterial infections. The container also includes a compartment for storing bags that serve to dispose of used sanitary tampons.

State of the art

According to current state of the art, a larger number of different cases and containers of various sizes and shapes exists that are used for the storage of tampons. However, current state of the art is not familiar with a container for tampons that has within itself a separate compartment intended for the storage of separate products, as in this case protective finger covers, which are placed on the finger when inserting a tampon into the vagina. Likewise, current state of the art is not familiar with a container that additionally has a compartment (storage area) intended for bags for the disposal of used tampons.

Disclosure of the invention

The primary objective of this invention is to offer women the possibility of transporting different necessary sanitary products (tampons) in one container, in addition to protective

finger covers that enable increased hygiene during their insertion into/removal from the vagina.

The secondary objective of this invention is to enable its users to gently push the sanitary product, i.e. the protective finger cover, outside of the container with their finger through the opening on the bottom portion of the container using a mobile sliding base.

Another objective of this invention is to ensure an additional compartment inside the container itself for the storage of bags intended for the waste disposal of used tampons. The mentioned additional compartment is functionally separated from the compartment where the tampons are placed, i.e. the central compartment for finger covers, to avoid intermixing of the two.

Another additional objective of this invention is to enable users the simpler and faster removal of sanitary tampon products from the container, which is achieved with an appropriately constructed lid with holes on the container's exterior.

All other objectives and advantages of the invention will partially be shown in the following description.

Brief description of figures

The enclosed figures included in the description, which constitute a part of the description of the invention, show the best manner of implementation of the invention, and assist in explaining the basic principles of the invention.

Figures 1a and 1b display a spatial view of the assembly consisting of the lid and interior container, while figure 1c and figure 1d display a side view of the lid-interior container assembly. Figure 1e displays a spatial view through the lid-interior container assembly with appropriately dashed parts, while figure 1f displays the cross section through the central axis of the lid-interior container assembly.

Figures 2a and 2b display a spatial view of the interior container, and figure 2c displays a spatial view through the interior container with appropriately dashed parts. Figure 2d displays the cross section through the central axis of the interior container. The interior container is displayed in layout and side views in figures 2e and 2f.

Figures 3a, 3b, 3c and 3d display the appropriate views of the appearance of the mobile sliding base.

Figures 4a and 4b display the spatial view of the lid from its upper and lower sides, and figure 4c displays the spatial view through the lid with appropriately dashed parts. Figure 4d displays the cross section through the central axis of the lid.

Figures 5a and 5b display the spatial view of the lower lid for empty bags from its upper and lower sides, and figure 5c displays the spatial view through the lower lid with appropriately dashed parts. Figure 5d displays the cross section through the central axis of the lower lid.

Detailed description of at least one implementation of the invention

This invention shows a multipurpose container for sanitary products that has a two-part housing, which consists of the interior container (1) and the lid (2). The lid (2), with its side wall, tightly overlies the container's exterior wall (3), which creates a close fit and a tight closing of the container. The interior container (1), in its preferably cylindrical interior, has at least two separate tampon compartments (4), a central compartment (5) intended to store protective finger covers (6). The opening of the central compartment (5) has a mobile sliding base (10) on its bottom side, which enables the gentle extraction of the finger covers from the container from the bottom upward.

The container preferably has 8 tampon compartments (4), which is a compartment capacity that is usually sufficient for 24-hour protection. Implementation of a larger number of tampon compartments (4) is possible, but ultimately results in a significantly larger container, which is not overly suitable for daily transport in a woman's handbag. Implementation of a smaller number of tampon compartments is likewise possible and with the construction of such a container, it is possible to reduce the final size of the container, i.e. the outside diameter of the interior container (1).

The tampon compartments (4) are each separated from one another and as such prevent the dissipation of tampons inside the container. The compartments are constructed on the inside rim of the cylindrical interior container (1). They are constructed in the manner whereby they are essentially semicircular walls (8) that extend from the bottom of the interior container (1) to approximately 1 cm from the top of the interior container (1). The semicircular walls (8) are constructed so that the exterior portion of the semicircular wall is situated in the central compartment (5), while the opened side is directed toward the corresponding opening (9) on the side wall of the interior container (1).

The interior container (1) has openings (9) situated on its side wall where the corresponding tampon compartment (4) is located within the inside, whereby the construction of those openings (9) enables the easier removal of the tampons from the container.

The central compartment (5) for protective finger covers (6) is situated in the center of the interior container (1), along its perpendicular axis. The stated central compartment (5) can essentially be a square or cylindrical shape with an opening on the upper and lower side. The central compartment (5) on the lower side has a mobile sliding base (10) that enables the finger cover to be gently pushed out of the container from the bottom upward, i.e. toward the upper side of the central compartment (5).

The lid (2) of the container in some of its implementations has a thread (11) executed on its lower interior side on which the lower lid (7) can optionally be secured, which represents a container intended to store bags for disposing of used tampons. In this manner, users have the possibility of storing used tampons in a sanitary fashion immediately after use and dispose of the same in the garbage. Unscrewing the lower lid (7) through the opening on its upper side, empty bags are restocked, and this is once again placed on the lid (2) in its initial position.

Application of the invention

The multipurpose container for sanitary products is used in the manner that the lid (2) is removed from the interior container (1), and a protective finger cover (6), which is placed on the user's finger, as well as an empty bag for the disposal of a used tampon, is taken from the central compartment (5). Then the used tampon is removed from the vagina and placed into an empty bag, and a new tampon that is taken from one of the tampon compartments (4) is inserted into the vagina.

All items used, tampons, protective finger covers and empty bags for used tampons are intended to be individually purchased by the user according to their personal preferences. It will be obvious to a professional in this field that many modifications and changes could have been made to the container for tampons according to this invention, without compromising the extent and essence of the invention.

List of reference designations

- (1) interior container
- (2) lid
- (3) outside wall of the container
- (4) tampon compartment
- (5) central compartment
- (6) protective finger covers
- (7) lower lid
- (8) semicircular wall
- (9) openings
- (10) mobile sliding base
- (11) thread

Patent claims

1. The multipurpose container for sanitary products, which has a two-part housing, that consists of the interior container (1) and the lid (2), which with its side wall tightly overlies the container's exterior wall (3), creating a close fit and tight closing of the container for sanitary products is **characterized by** the interior container (1) having at least two separate tampon compartments (4), a central compartment (5) intended to store protective finger covers (6), and where the central compartment (5) has a mobile sliding base (10) on its bottom side, which enables the gentle extraction of the finger covers from the container from the bottom upward.
2. The multipurpose container for sanitary products according to patent claim 1 is **characterized by** the tampon compartments (4) being separated from one another and as such prevent the dissipation of tampons inside the container.
3. The multipurpose container for sanitary products according to patent claim 2 is **characterized by** the tampon compartments (4) being constructed in the manner whereby they are essentially semicircular walls (8) that extend from the bottom of the interior container (1) to approximately 1 cm from the top of the interior container (1) and that the stated essentially semicircular walls (8) are constructed so that the exterior portion of the semicircular wall is situated in the central compartment (5).
4. The multipurpose container for sanitary products according to patent claim 1 is **characterized by** the interior container (1) having openings (9) situated on its side wall where the corresponding tampon compartment (4) is located within the inside, whereby those mentioned openings (9) enable the easier removal of the tampons from the container.
5. The multipurpose container for sanitary products according to patent claim 1 is **characterized by** the central compartment (5) for protective finger covers (6) having a mobile sliding base (10) that enables the finger covers to be gently pushed out of the container from the bottom upward, i.e. toward the upper side of the central compartment (5).

6. The multipurpose container for sanitary products according to patent claim 1 is **characterized by** the lid (2) having a lower lid (7) on its bottom side with a thread (11), which represents a container intended to store empty bags for disposing of used tampons.

7. The multipurpose container for sanitary products according to patent claim 1 is **characterized by** it preferably having 8 tampon compartments (4), which is a compartment capacity that is usually sufficient for 24-hour protection.

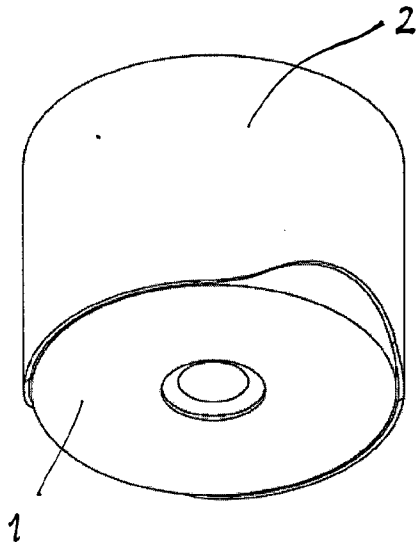

Fig. 1a

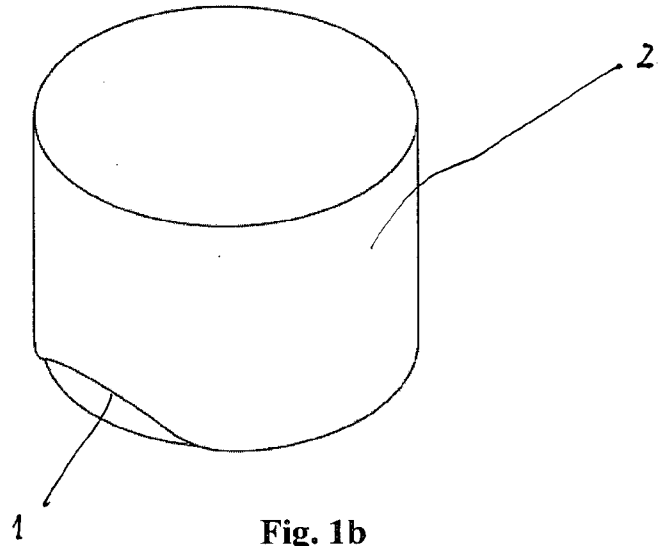

Fig. 1b

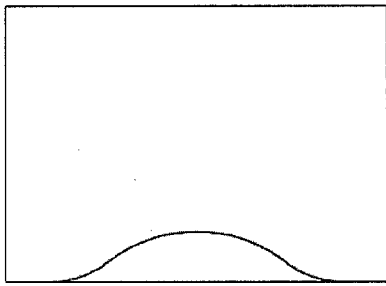

Fig. 1c

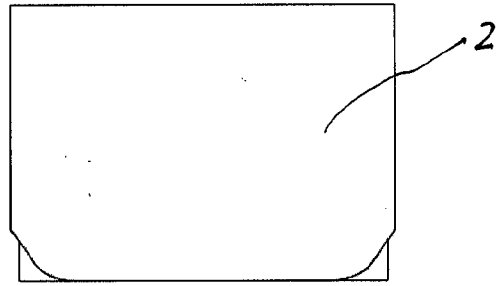

Fig. 1d

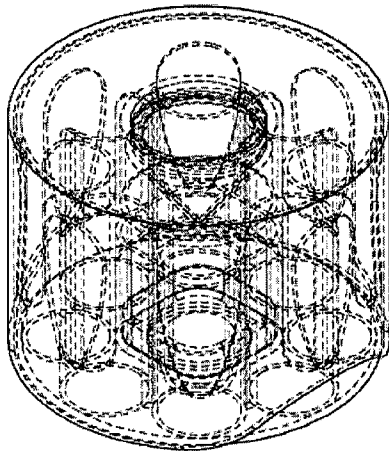

Fig. 1e

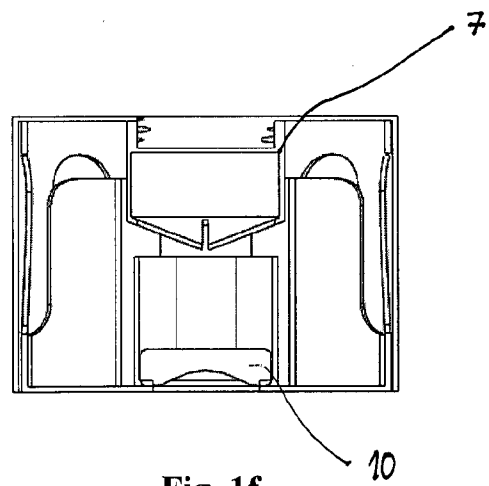

Fig. 1f

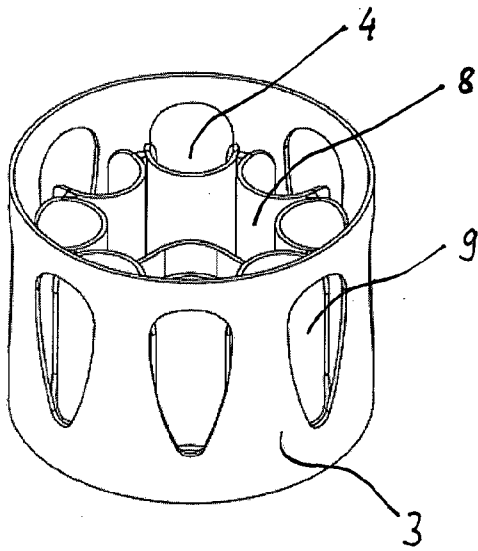

Fig. 2a

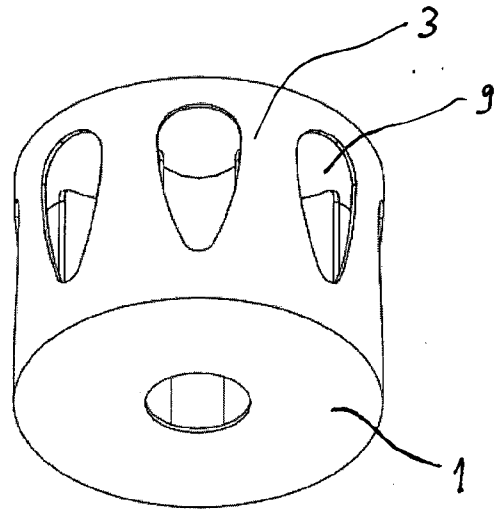

Fig. 2b

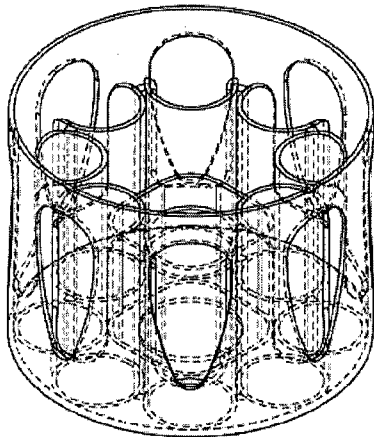

Fig. 2c

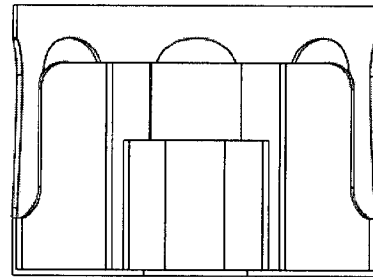

Fig. 2d

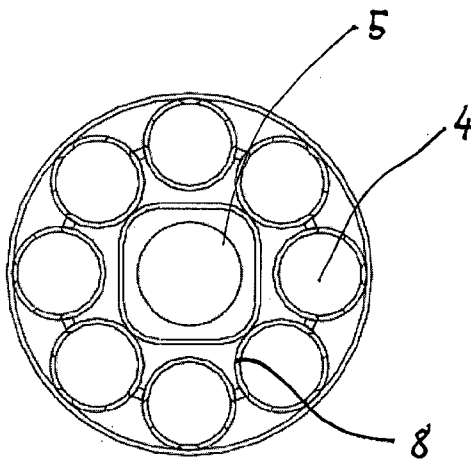

Fig. 2e

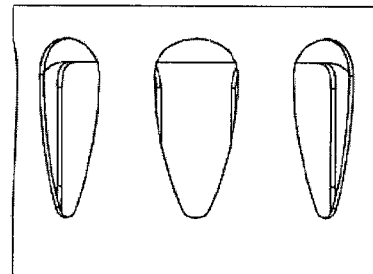

Fig. 2f

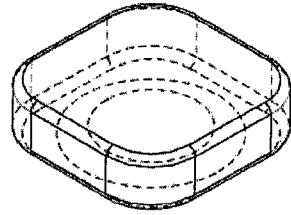

Fig. 3a

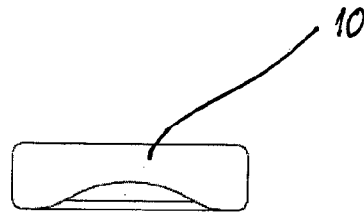

Fig. 3b

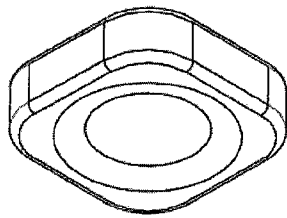

Fig. 3c

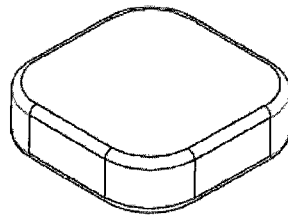

Fig. 3d

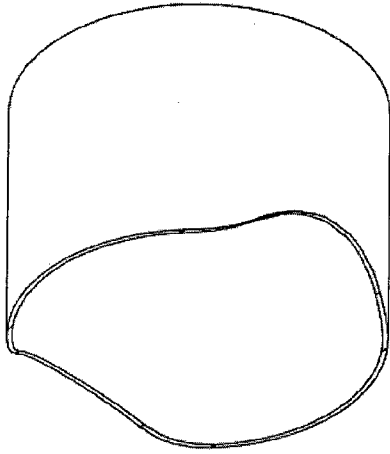

Fig. 4a

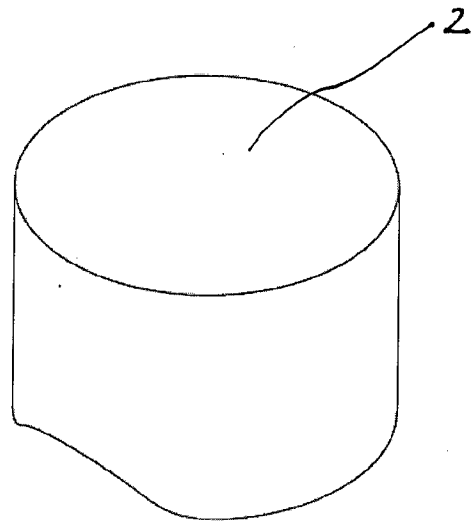

Fig. 4b

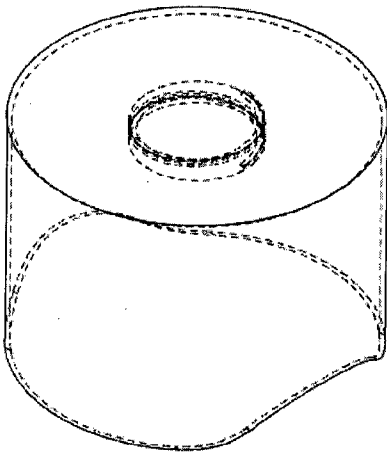

Fig. 4c

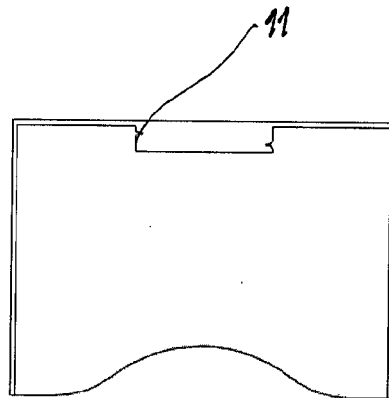

Fig. 4d

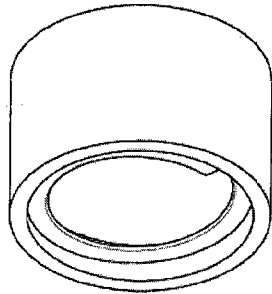

Fig. 5a

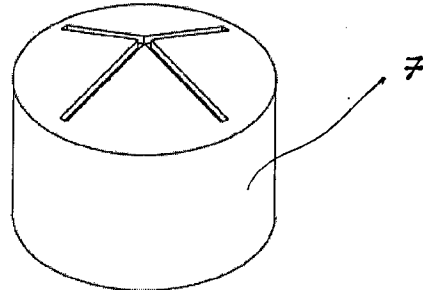

Fig. 5b

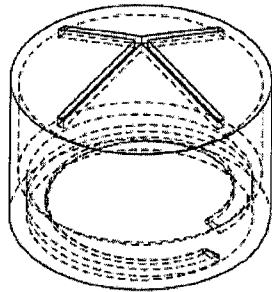

Fig. 5c

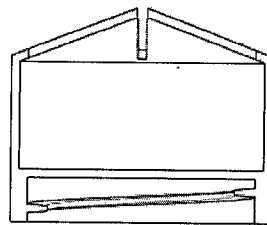

Fig. 5d

INTERNATIONAL SEARCH REPORT

International application No PCT/HR2014/000013

A. CLASSIFICATION OF SUBJECT MATTER INV. A61F15/00 A45C11/00 ADD.				
According to International Patent Classification (IPC) or to both national classification and IPC				
B. FIELDS SEARCHED				
Minimum documentation searched (classification system followed by classification symbols) A61F A45C B65D				
Documentation searched other than minimum documentation to the extent that such documents are included in the fields searched				
Electronic data base consulted during the international search (name of data base and, where practicable, search terms used) EPO-Internal, WPI Data				
C. DOCUMENTS CONSIDERED TO BE RELEVANT				
Category*	Citation of document, with indication, where appropriate, of the relevant passages	Relevant to claim No.		
A	WO 02/17844 A2 (PROCTER & GAMBLE [US]) 7 March 2002 (2002-03-07) page 5, line 19 - page 6, line 16 page 12, line 9 - line 24; claims 1,5; figures 1, 5D -----	1-7		
A	WO 2008/068739 A2 (KARAKUZ LINA [IL]; KARAKUZ VITALY [IL]) 12 June 2008 (2008-06-12) page 5 - page 6; figures 1,2 -----	1-7		
A	US 2005/109786 A1 (KREY L M [US]) 26 May 2005 (2005-05-26) paragraph [0016] paragraph [0036]; figures 1-7 -----	1-7		
-/--				
<input checked="" type="checkbox"/> Further documents are listed in the continuation of Box C. <input checked="" type="checkbox"/> See patent family annex.				
* Special categories of cited documents : <table style="width: 100%; border: none;"> <tr> <td style="width: 50%; border: none; vertical-align: top;"> "A" document defining the general state of the art which is not considered to be of particular relevance "E" earlier application or patent but published on or after the international filing date "L" document which may throw doubts on priority claim(s) or which is cited to establish the publication date of another citation or other special reason (as specified) "O" document referring to an oral disclosure, use, exhibition or other means "P" document published prior to the international filing date but later than the priority date claimed </td> <td style="width: 50%; border: none; vertical-align: top;"> "T" later document published after the international filing date or priority date and not in conflict with the application but cited to understand the principle or theory underlying the invention "X" document of particular relevance; the claimed invention cannot be considered novel or cannot be considered to involve an inventive step when the document is taken alone "Y" document of particular relevance; the claimed invention cannot be considered to involve an inventive step when the document is combined with one or more other such documents, such combination being obvious to a person skilled in the art "&" document member of the same patent family </td> </tr> </table>			"A" document defining the general state of the art which is not considered to be of particular relevance "E" earlier application or patent but published on or after the international filing date "L" document which may throw doubts on priority claim(s) or which is cited to establish the publication date of another citation or other special reason (as specified) "O" document referring to an oral disclosure, use, exhibition or other means "P" document published prior to the international filing date but later than the priority date claimed	"T" later document published after the international filing date or priority date and not in conflict with the application but cited to understand the principle or theory underlying the invention "X" document of particular relevance; the claimed invention cannot be considered novel or cannot be considered to involve an inventive step when the document is taken alone "Y" document of particular relevance; the claimed invention cannot be considered to involve an inventive step when the document is combined with one or more other such documents, such combination being obvious to a person skilled in the art "&" document member of the same patent family
"A" document defining the general state of the art which is not considered to be of particular relevance "E" earlier application or patent but published on or after the international filing date "L" document which may throw doubts on priority claim(s) or which is cited to establish the publication date of another citation or other special reason (as specified) "O" document referring to an oral disclosure, use, exhibition or other means "P" document published prior to the international filing date but later than the priority date claimed	"T" later document published after the international filing date or priority date and not in conflict with the application but cited to understand the principle or theory underlying the invention "X" document of particular relevance; the claimed invention cannot be considered novel or cannot be considered to involve an inventive step when the document is taken alone "Y" document of particular relevance; the claimed invention cannot be considered to involve an inventive step when the document is combined with one or more other such documents, such combination being obvious to a person skilled in the art "&" document member of the same patent family			
Date of the actual completion of the international search	Date of mailing of the international search report			
17 November 2014	27/11/2014			
Name and mailing address of the ISA/ European Patent Office, P.B. 5818 Patentlaan 2 NL - 2280 HV Rijswijk Tel. (+31-70) 340-2040, Fax: (+31-70) 340-3016	Authorized officer Demay, Stéphane			

INTERNATIONAL SEARCH REPORT

International application No
PCT/HR2014/000013

C(Continuation). DOCUMENTS CONSIDERED TO BE RELEVANT

Category*	Citation of document, with indication, where appropriate, of the relevant passages	Relevant to claim No.
A	US 4 142 649 A (FORGEY JAMES F) 6 March 1979 (1979-03-06) column 2, line 30 - column 4, line 5; figures 1-4 -----	1-7
A	US 5 730 294 A (BLOSSER JEAN [US] ET AL) 24 March 1998 (1998-03-24) column 1, line 57 - column 2, line 11 column 2, line 66 - column 3, line 31; figures 1-6 -----	1-7
A	US 2006/266663 A1 (RHEA AKEMI [US]) 30 November 2006 (2006-11-30) the whole document -----	1-7

INTERNATIONAL SEARCH REPORT

Information on patent family members

International application No PCT/HR2014/000013

Patent document cited in search report	Publication date	Patent family member(s)	Publication date
WO 0217844	A2	07-03-2002	AR 030585 A1 27-08-2003
			AU 8861001 A 13-03-2002
			EP 1315471 A2 04-06-2003
			JP 4808362 B2 02-11-2011
			JP 2004524867 A 19-08-2004
			PE 03102002 A1 13-04-2002
			US 7144391 B1 05-12-2006
			WO 0217844 A2 07-03-2002
WO 2008068739	A2	12-06-2008	NONE
US 2005109786	A1	26-05-2005	NONE
US 4142649	A	06-03-1979	NONE
US 5730294	A	24-03-1998	NONE
US 2006266663	A1	30-11-2006	NONE