



US00D342089S

United States Patent [19]

[11] Patent Number: **Des. 342,089**

Anavil et al.

[45] Date of Patent: **** Dec. 7, 1993**

[54] **WRITING INSTRUMENT**

[75] Inventors: **Por Anavil; Julian M. H. Deeley,**
both of Bangkok, Thailand

[73] Assignee: **D.T.C. Industries Limited, Bangkok,**
Thailand

[**] Term: **14 Years**

[21] Appl. No.: **803,387**

[22] Filed: **Dec. 4, 1991**

[52] U.S. Cl. **D19/49; D19/56**

[58] Field of Search **D19/35, 36, 41-51,**
D19/54-58, 81-85; 401/99, 100, 103, 104, 209,
29-35

[56] **References Cited**

U.S. PATENT DOCUMENTS

- D. 187,255 2/1960 Sams et al. D19/45 X
- D. 189,735 2/1961 Platt D19/50
- D. 201,063 5/1965 Kahn D19/54

- D. 242,450 11/1976 Jahraus D19/45
- D. 279,993 8/1985 Oka D19/45
- D. 287,028 12/1986 Thevenot D19/45 X
- D. 304,601 11/1989 Alskog D19/49

Primary Examiner—Nelson C. Holtje
Assistant Examiner—Martie Thompson
Attorney, Agent, or Firm—Hawes & Fischer

[57] CLAIM

The ornamental design for a writing instrument, as shown and described.

DESCRIPTION

FIG. 1 is a right front perspective view of a writing instrument showing our new design; FIG. 2 is a rear elevational view; FIG. 3 is a front elevational view; FIG. 4 is a left side elevational view; FIG. 5 is a right side elevational view; FIG. 6 is a top plan view; and, FIG. 7 is a bottom plan view thereof.

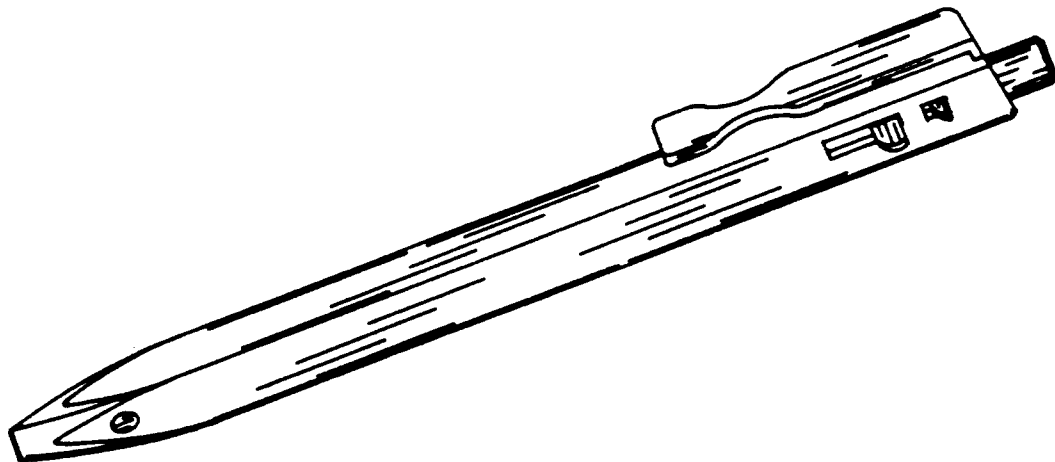

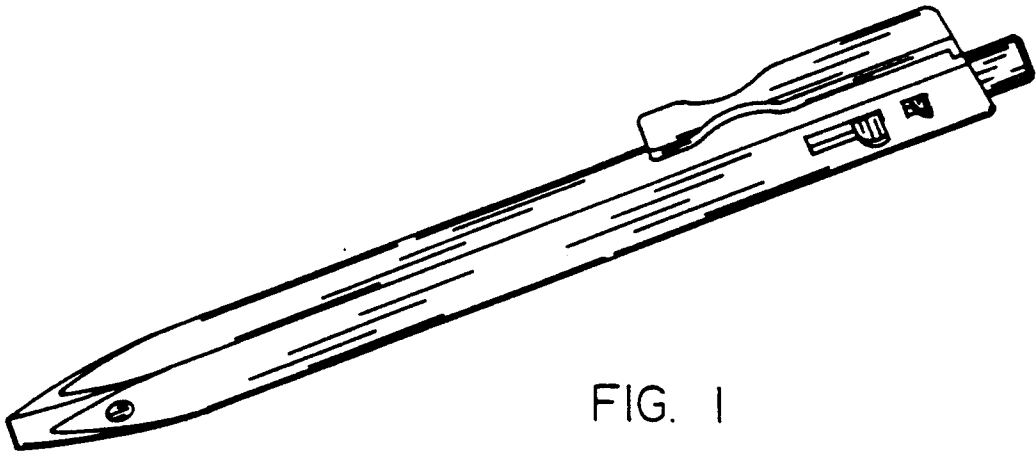

FIG. 1

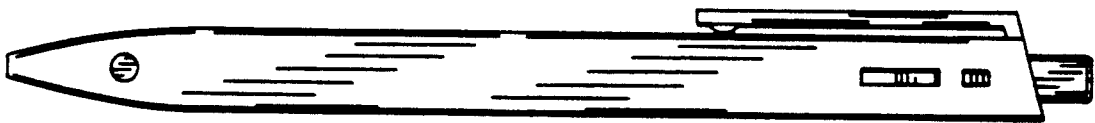

FIG. 2

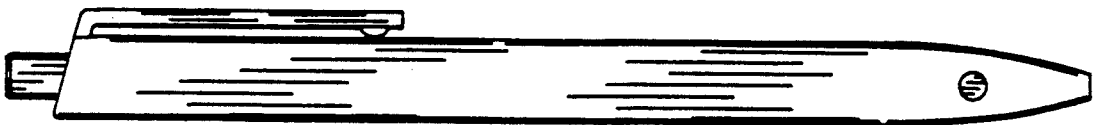

FIG. 3

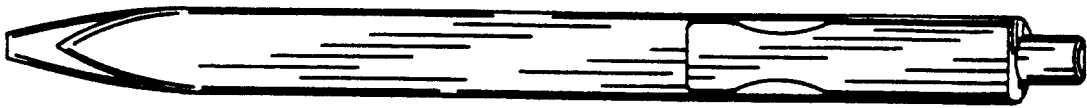

FIG. 4

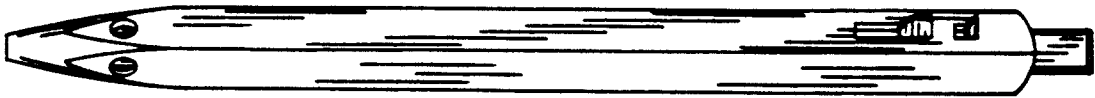

FIG. 5

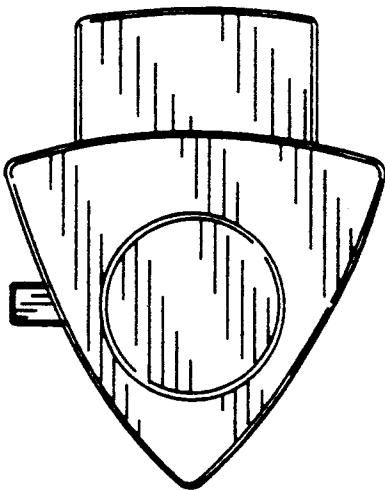

FIG. 6

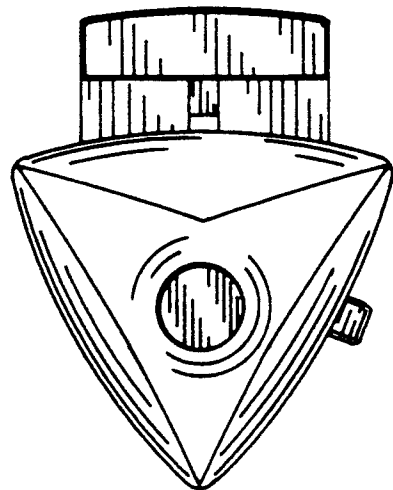

FIG. 7