



(12) **United States Design Patent**
Ramsey

(10) **Patent No.:** **US D897,793 S**
(45) **Date of Patent:** **** Oct. 6, 2020**

- (54) **SNOW RAKE**
- (71) Applicant: **Mark C. Ramsey**, Omaha, NE (US)
- (72) Inventor: **Mark C. Ramsey**, Omaha, NE (US)
- (**) Term: **15 Years**
- (21) Appl. No.: **29/698,797**
- (22) Filed: **Jul. 19, 2019**
- (51) **LOC (12) Cl.** **08-01**
- (52) **U.S. Cl.**
USPC **D8/10**
- (58) **Field of Classification Search**
USPC D8/1, 7-13, 107, 499
CPC A01B 1/04; A01B 1/02; A01B 1/12; A01B 1/18; A01B 13/00; A01D 34/412; A01D 34/416; A01G 3/00; A01G 3/053; A01G 3/062; A01G 3/0535; E01H 5/02
See application file for complete search history.

- D405,666 S * 2/1999 Whitehead D8/10
- D439,119 S * 3/2001 Colonello E01H 5/02
D8/13
- D475,257 S * 6/2003 Somers E04D 13/106
D8/10
- D539,496 S * 3/2007 Sickler D32/41
- 8,464,387 B1 * 6/2013 Cohen B08B 1/005
15/105
- 9,120,217 B2 9/2015 Fischer, Jr. et al.
- 9,567,718 B2 * 2/2017 Faraci E01H 5/02
- 2014/0215864 A1 * 8/2014 Fischer, Jr. E04D 13/106
37/266
- 2017/0101754 A1 * 4/2017 Zhou F21V 31/005

* cited by examiner

Primary Examiner — Sheryl Lane
Assistant Examiner — Calvin E Vansant
(74) *Attorney, Agent, or Firm* — Dennis L. Thomte;
Thomte Patent Law Office LLC

(57) **CLAIM**

The ornamental design for snow rake, as shown and described.

- (56) **References Cited**
- U.S. PATENT DOCUMENTS
- D32,363 S * 3/1900 Radley D8/13
 - D121,725 S * 7/1940 Winthrop D8/9
 - 2,432,780 A * 12/1947 Mader E01H 5/02
37/273
 - 2,728,598 A * 12/1955 Szillage A01B 1/02
294/53.5
 - D212,958 S * 12/1968 Golenski D8/10
 - D298,906 S * 12/1988 Bonnes D8/10
 - 5,067,197 A * 11/1991 Cormier A47L 13/11
15/244.1
 - 5,465,510 A 11/1995 Goodnough et al.
 - D384,867 S * 10/1997 Willis E01H 5/02
D8/13
 - 5,676,412 A * 10/1997 Kahley E01H 5/02
294/53.5

DESCRIPTION

FIG. 1 is a front perspective view of the snow rake of this invention;
FIG. 2 is a top view of the snow rake of this invention;
FIG. 3 is a front view of the snow rake of this invention;
FIG. 4 is an end view of the snow rake of this invention as seen from the right end of FIG. 3;
FIG. 5 is a back view of the snow rake of this invention;
FIG. 6 is an end view of the snow rake of this invention as seen from the right end of FIG. 5; and,
FIG. 7 is a bottom view of the snow rake of this invention.

1 Claim, 3 Drawing Sheets

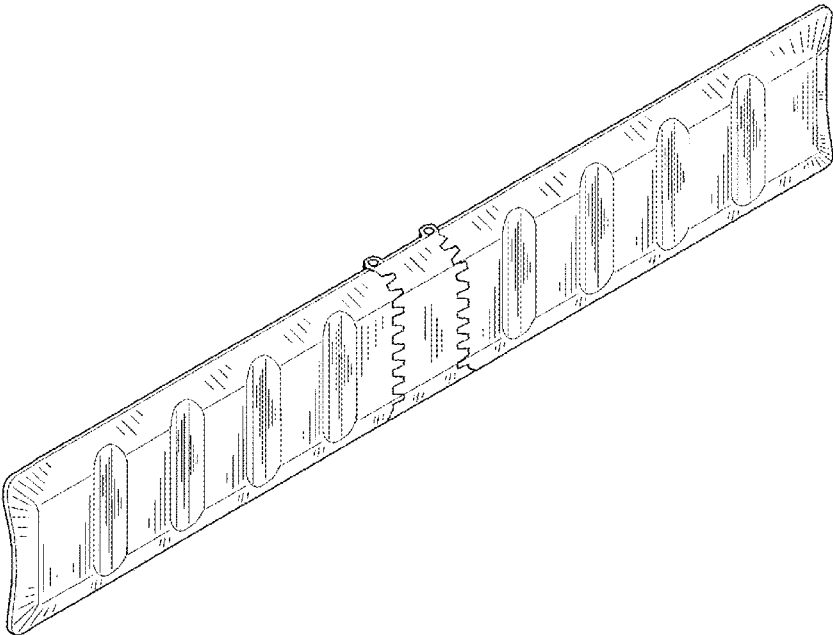

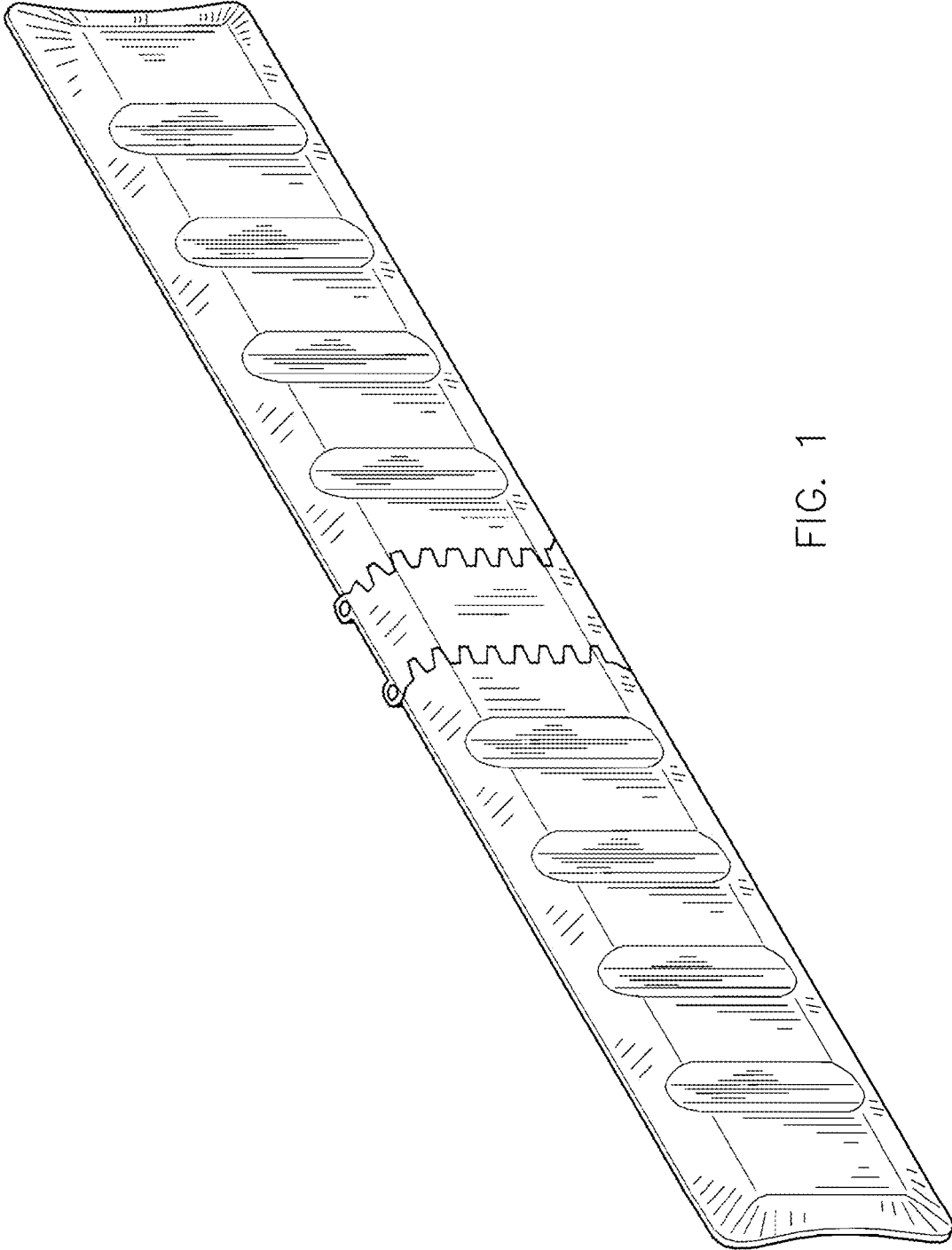

FIG. 1

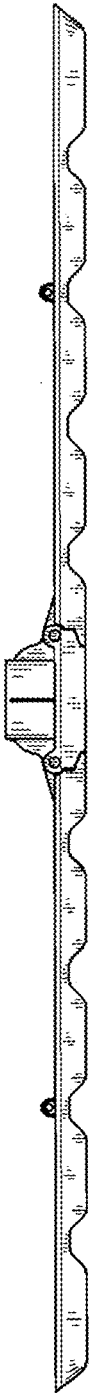

FIG. 2

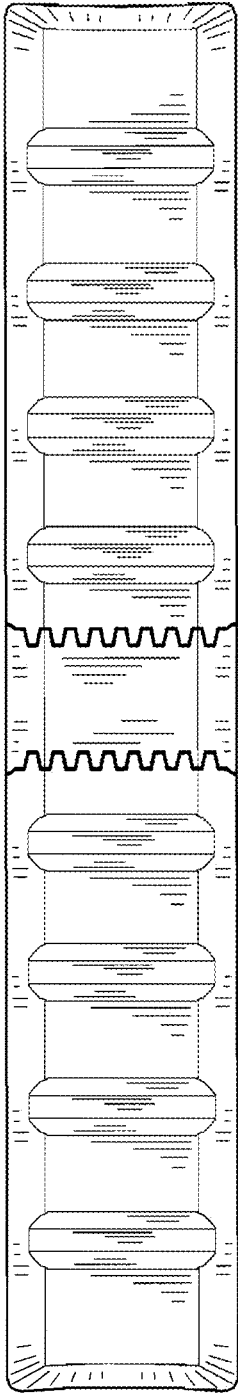

FIG. 3

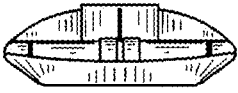

FIG. 4



FIG. 6

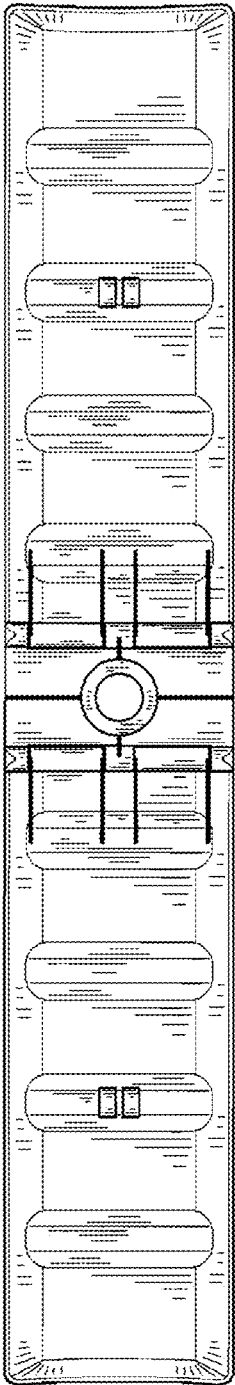

FIG. 5

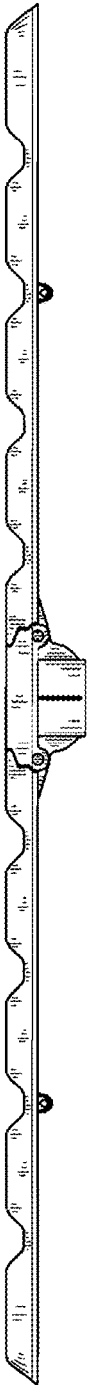

FIG. 7