



US00D540790S

(12) **United States Design Patent**
Kim et al.

(10) **Patent No.:** **US D540,790 S**

(45) **Date of Patent:** **** Apr. 17, 2007**

- (54) **PERSONAL DIGITAL ASSISTANT**
- (75) Inventors: **Young-Sae Kim**, Palo Alto, CA (US);
Chi-Young Ahn, Seodaemun-Gu (KR);
Beom-Ku Han, Seoul (KR);
Chang-Hwan Hwang, Goyang-Si (KR)
- (73) Assignee: **Samsung Electronics Co., Ltd.**,
Suwon-Si (KR)
- (**) Term: **14 Years**

5,712,760 A	*	1/1998	Coulon et al.	361/680
D394,045 S	*	5/1998	Iino	D14/320
5,995,025 A	*	11/1999	Sternglass et al.	341/22
D417,657 S	*	12/1999	Matsumoto	D14/343
6,144,358 A	*	11/2000	Narayanaswamy et al.	345/102
D448,032 S	*	9/2001	Talley	D14/396
D457,525 S	*	5/2002	Olodort et al.	D14/396
D470,493 S	*	2/2003	Tritschler et al.	D14/393
D470,841 S	*	2/2003	Feierbach	D14/345
D486,488 S	*	2/2004	Olodort et al.	D14/396
6,798,649 B1	*	9/2004	Olodort et al.	361/683

* cited by examiner

Primary Examiner—Freda S. Nunn

(74) *Attorney, Agent, or Firm*—Staas & Halsey LLP

(21) Appl. No.: **29/234,757**

(22) Filed: **Jul. 22, 2005**

(30) **Foreign Application Priority Data**

Jan. 26, 2005 (KR) 30-2005-0002644

(51) **LOC (8) Cl.** **14-02**

(52) **U.S. Cl.** **D14/345**

(58) **Field of Classification Search** D14/391–396,
D14/320, 341–346; D18/1, 2, 7, 11; 178/17 A,
178/17 C; 200/5 A, 5 R, 6 A, 6 R; 345/102,
341/22, 23; 235/145 A, 145 R; 400/472,
400/479, 484–489; 361/680–686

See application file for complete search history.

(56) **References Cited**

U.S. PATENT DOCUMENTS

5,457,453 A * 10/1995 Chiu et al. 341/22

(57) **CLAIM**

The ornamental design for the personal digital assistant, as shown and described.

DESCRIPTION

FIG. 1 is a perspective view of the personal digital assistant showing our design;
FIG. 2 is a front view thereof;
FIG. 3 is a rear view thereof;
FIG. 4 is a left side view thereof;
FIG. 5 is a right side view thereof;
FIG. 6 is a top plan view thereof;
FIG. 7 is a bottom plan view thereof; and,
FIG. 8 is an open view thereof fully open.

1 Claim, 5 Drawing Sheets

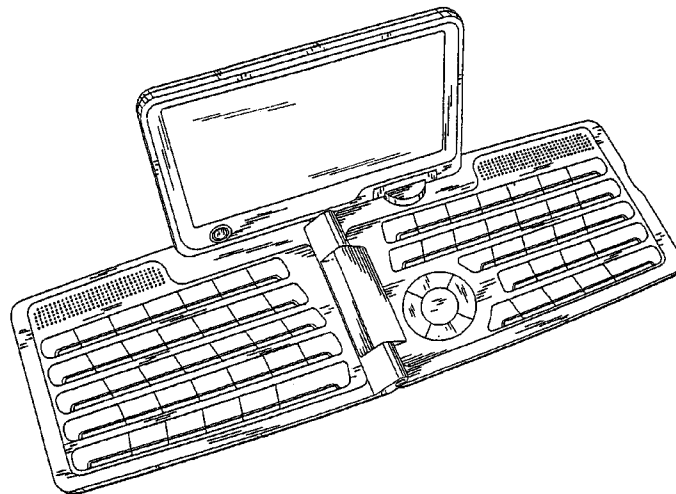
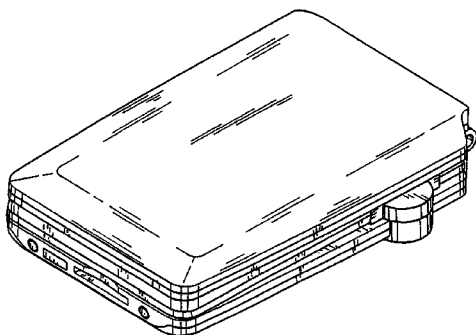

FIG. 1

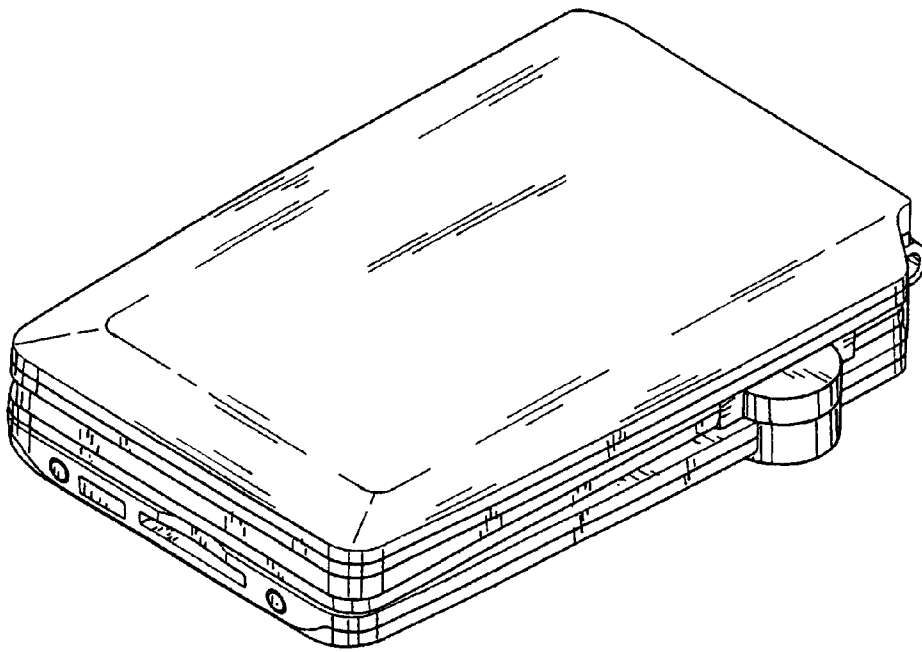

FIG. 2

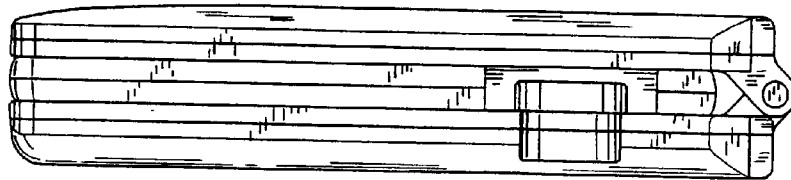

FIG. 3

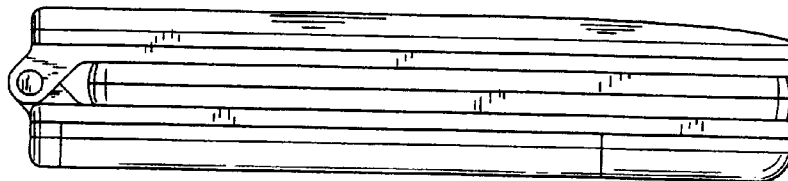

FIG. 4

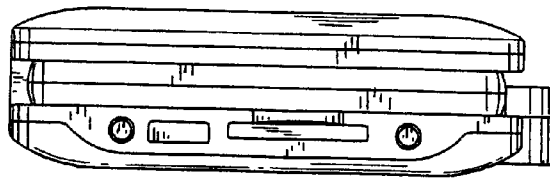

FIG. 5

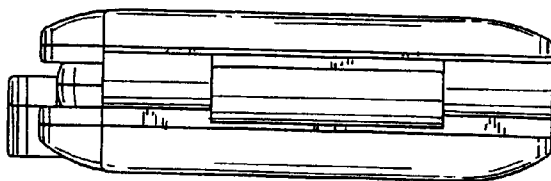

FIG. 6

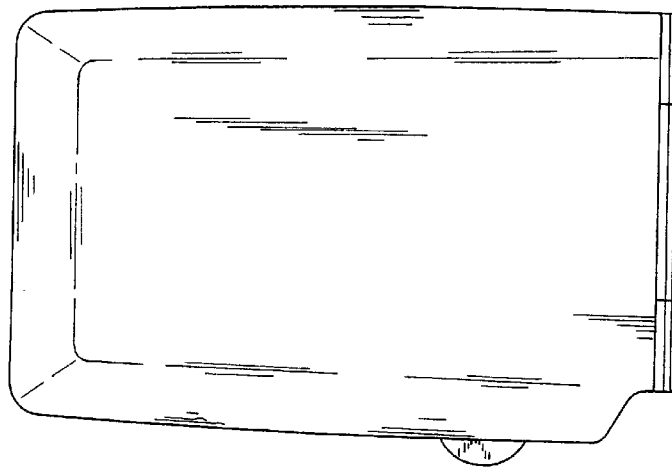

FIG. 7

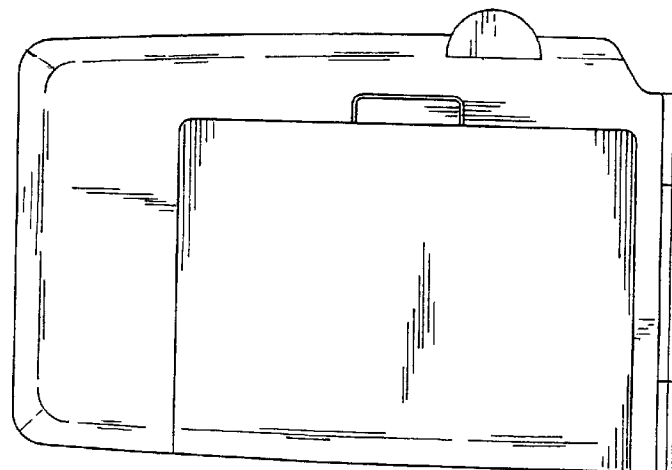

FIG. 8

