



US00D342833S

United States Patent [19]

[11] Patent Number: **Des. 342,833**

Huang

[45] Date of Patent: **** Jan. 4, 1994**

[54] **DIRT BRUSH**

[76] Inventor: **Yung-Ming Huang**, No. 81, Ta Jen Miao, Ta-Miao Tsun., Kuei-Jen Hsiang, Tainan Hsien, Taiwan

[**] Term: **14 Years**

[21] Appl. No.: **886,479**

[22] Filed: **May 22, 1992**

[52] U.S. Cl. **D4/136**

[58] Field of Search D4/130, 134, 136-138; 199 15/112, 159.1, 160-161, 215, 217, 237-238

[56] **References Cited**

U.S. PATENT DOCUMENTS

D. 286,952	12/1986	Leroux	D4/136
899,515	9/1908	De Lapp	15/112
4,819,984	4/1989	Wylie	15/112 X

Primary Examiner—Wallace R. Burke
Assistant Examiner—Lavone D. Tabor
Attorney, Agent, or Firm—Morton J. Rosenberg; David I. Klein

[57] **CLAIM**

The ornamental design for a dirt brush, as shown and described.

DESCRIPTION

FIG. 1 is a perspective view of a dirt brush showing my new design;
FIG. 2 is a front elevational view thereof;
FIG. 3 is a rear elevational view thereof;
FIG. 4 is a right side elevational view thereof;
FIG. 5 is a left side elevational view thereof;
FIG. 6 is a top plan view thereof; and,
FIG. 7 is a bottom plan view thereof.

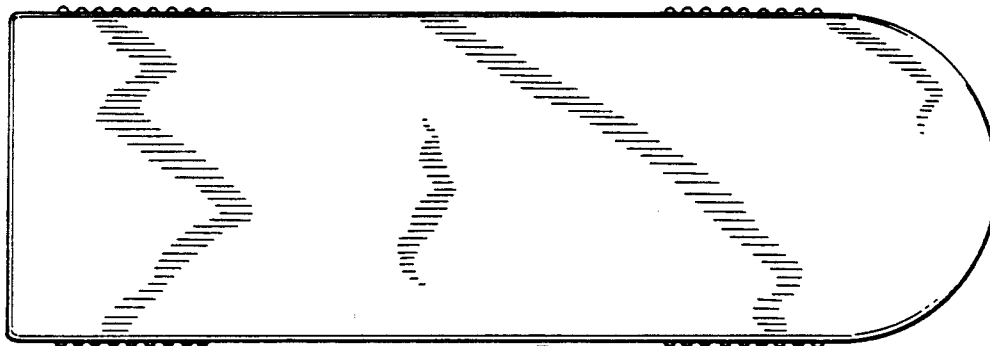
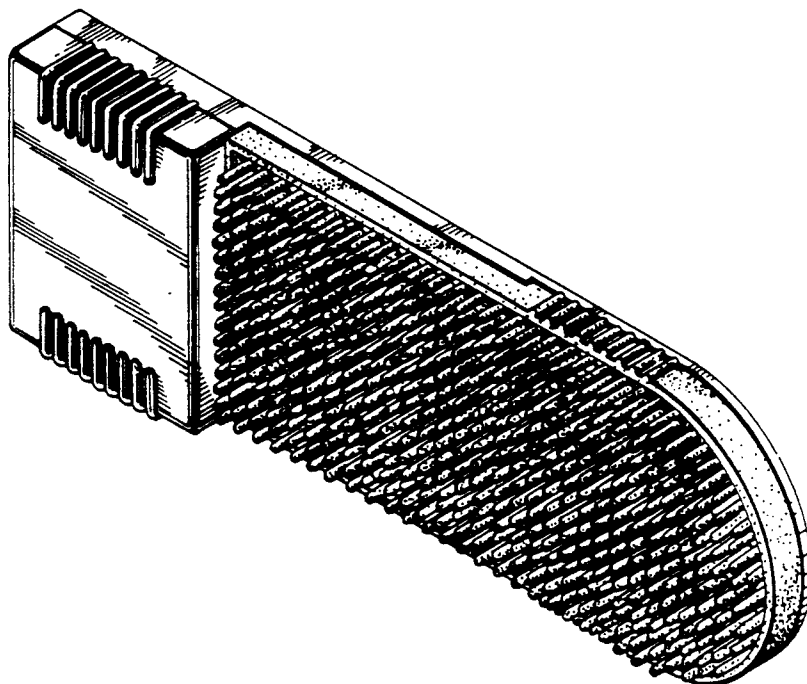

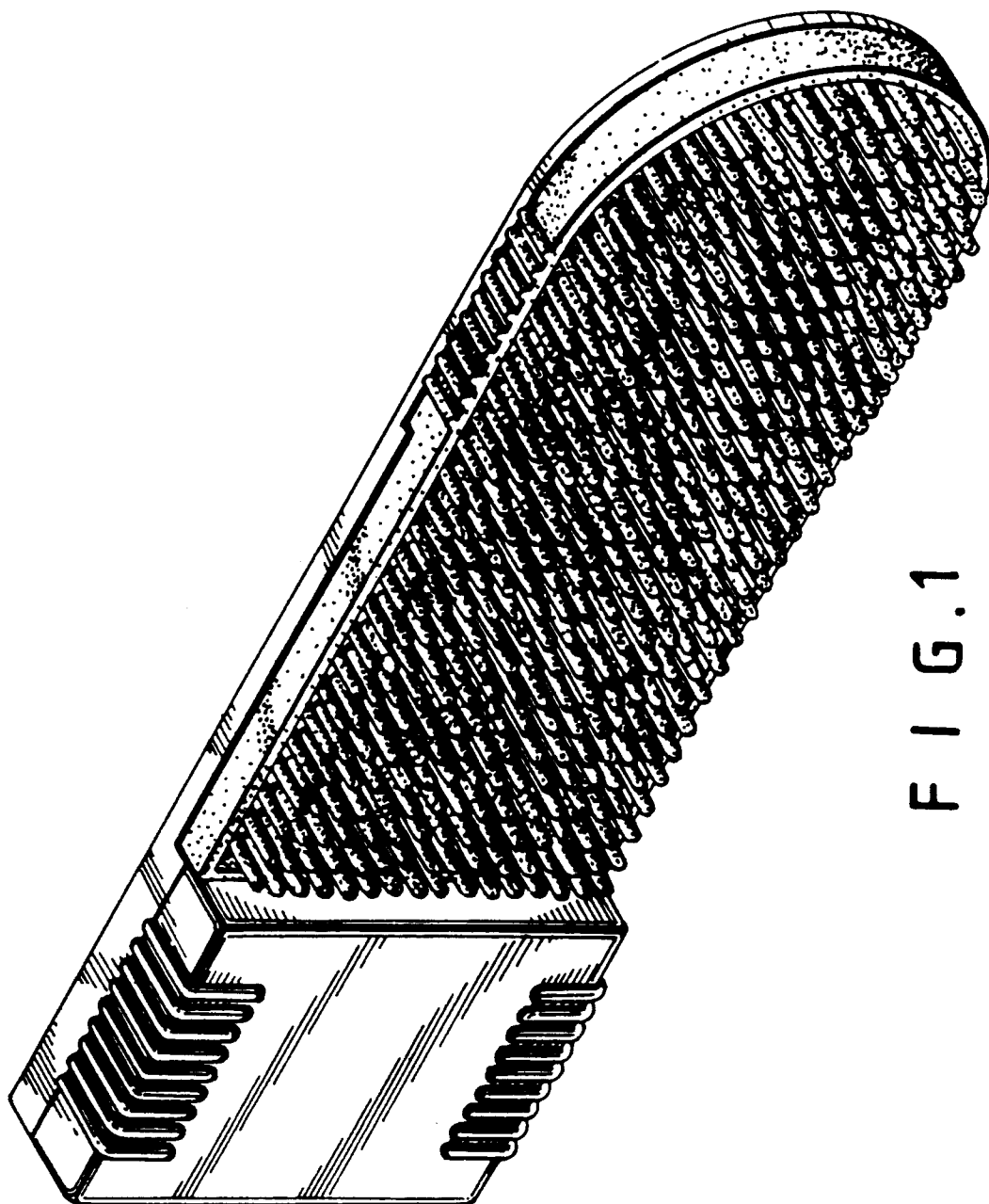

FIG. 1

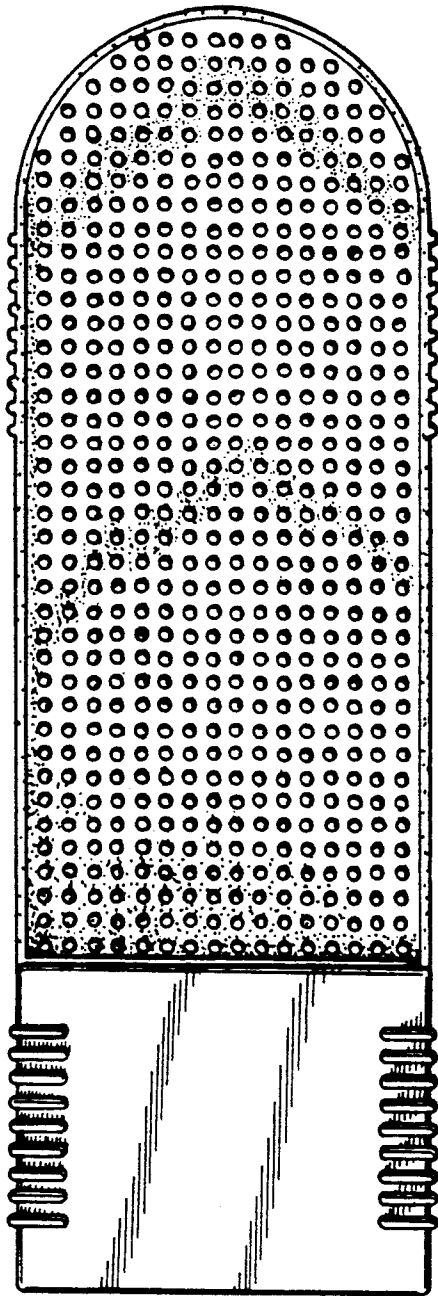

FIG. 2

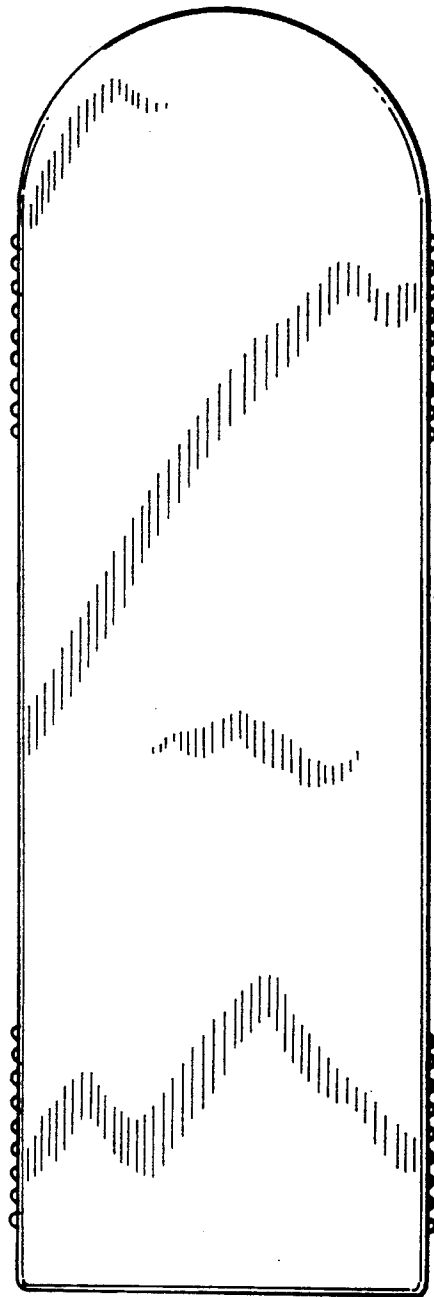

FIG. 3

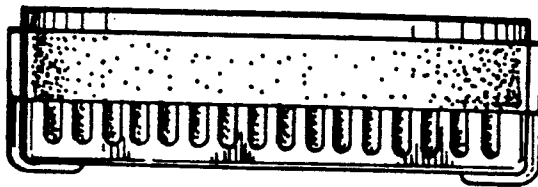

FIG. 4

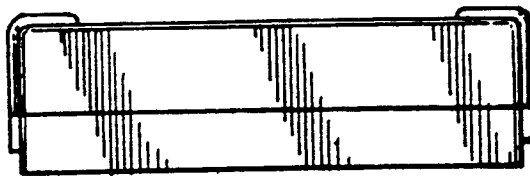

FIG. 5

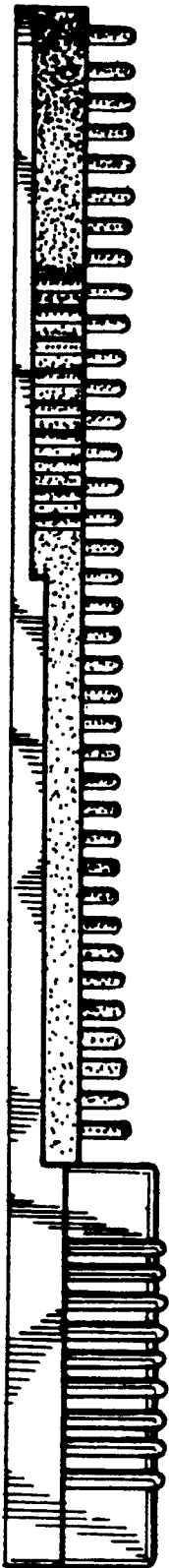

FIG. 6

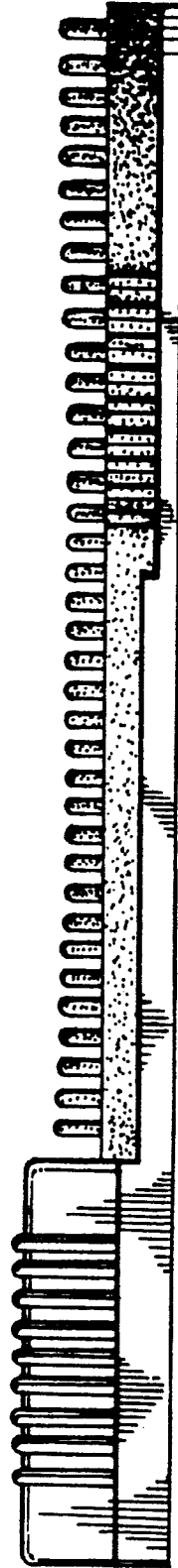

FIG. 7