



- (51) International Patent Classification:  
H04L 29/08 (2006.01)
- (21) International Application Number:  
PCT/KR2015/014212
- (22) International Filing Date:  
23 December 2015 (23.12.2015)
- (25) Filing Language: English
- (26) Publication Language: English
- (30) Priority Data:  
10-2014-0195468  
31 December 2014 (31.12.2014) KR
- (71) Applicant: SAMSUNG ELECTRONICS CO., LTD.  
[KR/KR]; 129, Samsung-ro, Yeongtong-gu, Suwon-si,  
Gyeonggi-do 16677 (KR).
- (72) Inventor: MOON, Jicheol; No. 9-907, 104, Olympic-ro  
35-gil, Songpa-gu, Seoul 05504 (KR).
- (74) Agent: YOON, Dong Yol; Yoon & Lee International Pat-  
ent & Law Firm, 3rd Fl, Ace Highend Tower-5, 226, Gasan  
Digital 1-ro, Geumcheon-gu, Seoul 08502 (KR).

- (81) Designated States (unless otherwise indicated, for every kind of national protection available): AE, AG, AL, AM, AO, AT, AU, AZ, BA, BB, BG, BH, BN, BR, BW, BY, BZ, CA, CH, CL, CN, CO, CR, CU, CZ, DE, DK, DM, DO, DZ, EC, EE, EG, ES, FI, GB, GD, GE, GH, GM, GT, HN, HR, HU, ID, IL, IN, IR, IS, JP, KE, KG, KN, KP, KZ, LA, LC, LK, LR, LS, LU, LY, MA, MD, ME, MG, MK, MN, MW, MX, MY, MZ, NA, NG, NI, NO, NZ, OM, PA, PE, PG, PH, PL, PT, QA, RO, RS, RU, RW, SA, SC, SD, SE, SG, SK, SL, SM, ST, SV, SY, TH, TJ, TM, TN, TR, TT, TZ, UA, UG, US, UZ, VC, VN, ZA, ZM, ZW.
- (84) Designated States (unless otherwise indicated, for every kind of regional protection available): ARIPO (BW, GH, GM, KE, LR, LS, MW, MZ, NA, RW, SD, SL, ST, SZ, TZ, UG, ZM, ZW), Eurasian (AM, AZ, BY, KG, KZ, RU, TJ, TM), European (AL, AT, BE, BG, CH, CY, CZ, DE, DK, EE, ES, FI, FR, GB, GR, HR, HU, IE, IS, IT, LT, LU, LV, MC, MK, MT, NL, NO, PL, PT, RO, RS, SE, SI, SK, SM, TR), OAPI (BF, BJ, CF, CG, CI, CM, GA, GN, GQ, GW, KM, ML, MR, NE, SN, TD, TG).

Published:  
— with international search report (Art. 21(3))

(54) Title: METHOD AND APPARATUS FOR ALLOCATING SERVER IN WIRELESS COMMUNICATION SYSTEM

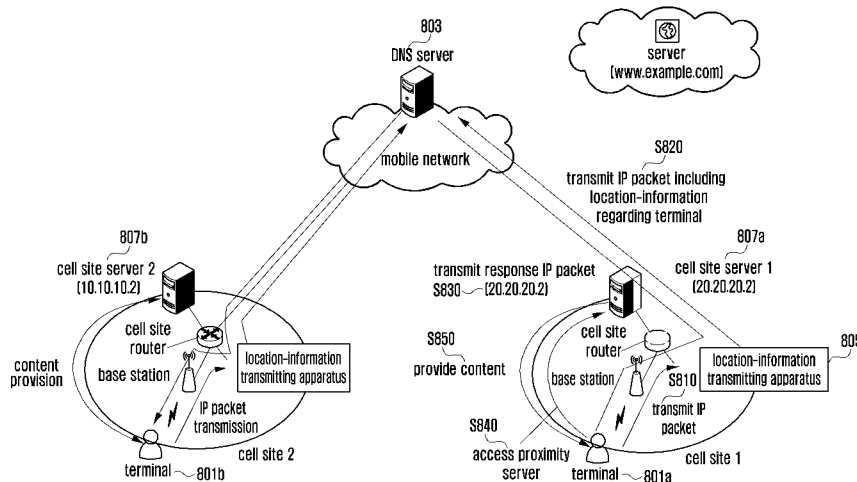

(57) Abstract: A method and an apparatus for allocating a server to a terminal are provided. The method includes receiving an Internet protocol (IP) packet with a domain name system (DNS) query from a terminal, including terminal location information in the IP packet, transmitting the IP packet to a DNS server, receiving, from the DNS server, a response IP packet location information of a proximity server, the proximity server being located within a certain distance from the terminal, and transmitting the response IP packet to the terminal.

WO 2016/108509 A1

## Description

### **Title of Invention: METHOD AND APPARATUS FOR ALLOCATING SERVER IN WIRELESS COMMUNICATION SYSTEM**

#### **Technical Field**

- [1] The present disclosure relates to a server allocation system. More particularly, the present disclosure relates to a method and apparatus for allocating a server closest to a terminal (i.e., a proximity server).

#### **Background Art**

- [2] In recent years, the development of communication technology has led to various types of terminals (electronic devices) that access the Internet. Terminals need Internet protocol (IP) addresses to access the Internet. When a domain name address is input to a terminal, the transmission control protocol (TCP)/IP network converts the domain name address into the IP address by using a domain name server (DNS) and allows the terminal to access the website.
- [3] When domain name servers are installed in cell sites, the terminal user can experience a high quality of service and the communication service provider can also reduce the network load.

#### **Disclosure of Invention**

##### **Technical Problem**

- [4] Although DNS servers of the related art can distinguish between Internet service providers (ISPs) from the IP address of DNS messages, such DNS servers cannot distinguish between locations of cell sites.
- [5] The above information is presented as background information only to assist with an understanding of the present disclosure. No determination has been made, and no assertion is made, as to whether any of the above might be applicable as prior art with regard to the present disclosure.

##### **Solution to Problem**

- [6] Aspects of the present disclosure are to address at least the above-mentioned problems and/or disadvantages and to provide at least the advantages described below. Accordingly, an aspect of the present disclosure is to provide a system for allocating a server closest to a terminal (i.e., a proximity server) to the terminal by using the location information regarding the terminal.
- [7] In accordance with an aspect of the present disclosure, a location-information transmitting apparatus for allocating a server to a terminal is provided. The location-

information transmitting apparatus includes a communication unit configured to communicate with other network entities, and a controller configured to receive an Internet protocol (IP) packet with a domain name system (DNS) query from the terminal, include terminal location information in the IP packet, transmit the IP packet to a DNS server, received, from the DNS server, a response IP packet with location information of a proximity server, the proximity server being located within a certain distance from the terminal, and transmit the response IP packet to the terminal.

[8] In accordance with another aspect of the present disclosure, a DNS server for allocating a server to a terminal is provided. The DNS server includes a communication unit configured to communicate with other network entities, and a controller configured to control the communication unit to receive an IP packet with terminal location information from a location-information transmitting apparatus, and control the communication unit to transmit, to a location-information transmitting apparatus, a response IP packet with location information of a proximity server based on the terminal location information, the proximity server being located in a certain distance from the terminal.

[9] In accordance with another aspect of the present disclosure, a method for a location-information transmitting apparatus to allocate a server to a terminal is provided. The method includes receiving an IP packet with a DNS query from the terminal, including terminal location information in the IP packet, transmitting the IP packet to a DNS server, and receiving, from the DNS server, a response IP packet with location information of a proximity server, the proximity server being located within a certain distance from the terminal, and transmitting the response IP packet to the terminal.

[10] In accordance with another aspect of the present disclosure, a method for a DNS server to allocate a server to a terminal is provided. The method includes receiving an IP packet with terminal location information from a location-information transmitting apparatus, and transmitting, to the location-information transmitting apparatus, a response IP packet with location information of a proximity server based on the terminal location information, the proximity server being located within a certain distance from the terminal.

[11] Other aspects, advantages, and salient features of the disclosure will become apparent to those skilled in the art from the following detailed description, which, taken in conjunction with the annexed drawings, discloses various embodiments of the present disclosure.

### **Advantageous Effects of Invention**

[12] According to the present invention, if a server near the user can be allocated using the location information of the terminal, the user can receive service from the

proximity server. Through the above, the quality of experience of the user increases and network load decreases.

### **Brief Description of Drawings**

[13] The above and other aspects, features, and advantages of certain embodiments of the present disclosure will be more apparent from the following description taken in conjunction with the accompanying drawings, in which:

[14] FIG. 1 is a block diagram of apparatus for transmitting location-information according to an embodiment of the present disclosure;

[15] FIG. 2 is a block diagram of a domain name system (DNS) server according to an embodiment of the present disclosure;

[16] FIG. 3 is a diagram illustrating a method for providing content to a terminal by using a DNS server and an edge server according to an embodiment of the present disclosure;

[17] FIG. 4 is a flow diagram illustrating a method for providing content to a terminal by using a DNS server and an edge server according to an embodiment of the present disclosure;

[18] FIG. 5 is a diagram that illustrates a problem when a server is installed to a cell site according to an embodiment of the present disclosure;

[19] FIG. 6 is a structure of an Internet protocol (IP) packet including a DNS query according to an embodiment of the present disclosure;

[20] FIG. 7 is a diagram that illustrates a method for allocating a proximity server to a terminal using a location-information transmitting apparatus according to an embodiment of the present disclosure;

[21] FIG. 8 is a diagram that illustrates a method for allocating a proximity server according to an embodiment of the present disclosure;

[22] FIG. 9 is a flow diagram that illustrates a method for allocating a proximity server according to an embodiment of the present disclosure; and

[23] FIG. 10 is a diagram that describes a method of transmitting, to a server, a video taken by a closed-circuit television (CCTV) system, via a location-information transmitting apparatus according to an embodiment of the present disclosure.

[24] Throughout the drawings, like reference numerals will be understood to refer to like parts, components, and structures.

### **Mode for the Invention**

[25] The following description with reference to the accompanying drawings is provided to assist in a comprehensive understanding of various embodiments of the present disclosure as defined by the claims and their equivalents. It includes specific details to assist in that understanding but these are to be regarded as merely exemplary. Ac-

Accordingly, those of ordinary skill in the art will recognize that various changes and modifications of the various embodiments described herein can be made without departing from the scope and spirit of the present disclosure. In addition, descriptions of well-known functions and constructions may be omitted for clarity and conciseness.

[26] The terms and words used in the following description and claims are not limited to the bibliographical meanings, but, are merely used by the inventor to enable a clear and consistent understanding of the present disclosure. Accordingly, it should be apparent to those skilled in the art that the following description of various embodiments of the present disclosure is provided for illustration purpose only and not for the purpose of limiting the present disclosure as defined by the appended claims and their equivalents.

[27] It is to be understood that the singular forms “a,” “an,” and “the” include plural referents unless the context clearly dictates otherwise. Thus, for example, reference to “a component surface” includes reference to one or more of such surfaces.

[28] Any particular terminology describing certain features or aspects of the present disclosure is not suggestive of language restricted to any specific characteristics, features, or aspects of the present disclosure with which that terminology is associated.

[29] FIG. 1 is a block diagram of an apparatus for transmitting location-information according to an embodiment of the present disclosure.

[30] Referring to FIG. 1, the location-information transmitting apparatus includes a communication unit 110, a location-information storage unit 120 and a controller 130.

[31] The communication unit 110 performs transmission/reception of data to access a network server. The communication unit 110 is capable of receiving Internet protocol (IP) packets from a terminal. The communication unit 110 is capable of inserting the terminal location information into the IP packet and transmitting the IP packet to a domain name system (DNS) server. The communication unit 110 is capable of receiving the IP packet from the DNS server and transmitting the IP packet to the terminal.

[32] In order to include terminal location information in the IP packets, the communication unit 110 is capable of receiving location-information of the terminal from another network entity.

[33] The location-information storage unit 120 is capable of storing location-information of a terminal that is transmitted from the communication unit 110. The storage unit 120 is also capable of storing location-information of a terminal that is created in the controller 130.

[34] The location information of a terminal may include a cell identifier where a terminal is located, a base station identifier of a cell where a terminal is located, or a latitude and a longitude of where a terminal is located, etc. The terminal location information may also include an IP address of a proximity server, cell-site location information, ge-

ographical location information of a terminal, identifiers of the location information, etc.

[35] The location information of a terminal may be transmitted from another network entity to the location-information transmitting apparatus. The location information of a terminal may be created by the controller 130.

[36] The controller 130 controls all the operations of the apparatus according to an embodiment of the present disclosure. When the controller 130 receives an IP packet from a terminal, it is capable of inserting the terminal location information from another network entity into the IP packet. The controller 130 is also capable of creating the terminal location information and including the created location information in the IP packet received from the terminal. The controller 130 is capable of performing control operations to transmit the IP packet including the terminal location information to a DNS server.

[37] The terminal location information may include at least one of: an IP address of a proximity server, a cell-site location information, geographical location information of a terminal, and identifiers of the location information.

[38] The proximity server refers to a cell site server closest to a terminal and the detailed description will be explained later.

[39] FIG. 2 is a block diagram of a DNS server according to an embodiment of the present disclosure.

[40] Referring to FIG. 2, the DNS server is capable of including a communication unit 210, a storage unit 220 and a controller 230.

[41] The communication unit 210 is capable of receiving IP packets from a terminal and transmitting the response IP packets corresponding to the received IP packets to the terminal. The communication unit 210 is capable of receiving IP packets transmitted from another network entity.

[42] The storage unit 220 is capable of storing IP information of an IP address corresponding to a domain name. When a user inputs a domain name into the terminal, the domain name is converted into an IP address and the IP address is transmitted to the terminal.

[43] The IP information may include a number of IP addresses corresponding to the same domain name. That is, a number of servers with the same domain name may exist, and the respective IP addresses may be stored in the storage unit 220.

[44] The controller 230 receives IP packets from a terminal and creates packets corresponding to the received IP packets, which are referred to as response IP packets.

[45] The response IP packets may include an IP address of a server within a certain distance from the terminal. In the embodiment of the present disclosure, a server within a certain distance from the terminal refers to a server closest to the terminal.

That is, the controller 230 is capable of creating the response IP packet including an IP address of a server closest to a user, using the terminal location included in the received IP packet, from among the IP addresses of servers corresponding to a domain name. The controller 230 is capable of transmitting the response IP packets to the terminal.

- [46] FIG. 3 is a diagram illustrating a method for providing content to a terminal by using a DNS server and an edge server according to an embodiment of the present disclosure.
- [47] With the development of communication technology, a various type of terminals (electronic devices) have been released, so that users can access the Internet using the terminals.
- [48] Users can access the Internet by using terminals such as, for example, smartphones, tablets, etc., as well as computers.
- [49] Referring to FIG. 3, a user inputs a domain name into a terminal 301 to access a particular website over the Internet. The domain name may be previously specified according to the Internet servers. For example, to access a server of the Korean Intellectual Patent Office, the pre-specified domain name, www.kipo.go.kr, is input to the terminal. When a domain name is input to the terminal 301, an IP packet including a DNS query is transmitted to the DNS server in operation S310.
- [50] FIG. 6 is a structure of an Internet protocol (IP) packet including a DNS query according to an embodiment of the present disclosure.
- [51] Referring to FIG. 6, an IP packet may include an IP header 601, a user datagram protocol (UDP) header 603, and a DNS message part 605 including a DNS query or DNS response message.
- [52] The IP header 601 includes an IP address of a terminal transmitting IP packets and an IP address of a destination to receive the IP packets. When a terminal performs transmission of IP packets, the IP packets are transmitted to the destination via the destination IP address included in the IP header. When a server receives the IP packets, it may transmit the response for the received IP packets to the terminal via the terminal IP address included in the IP header.
- [53] The IP address may be included in the UDP header 603 or the DNS message part 605.
- [54] Referring back to FIG. 3, the IP packets transmitted from the terminal may be transmitted to the DNS server 303 that provides content delivery network (CDN) services.
- [55] The DNS server 303 is capable of storing IP addresses of respective domain names. When receiving a domain name included in an IP packet, the DNS server 303 is capable of transmitting, to the terminal, the response IP packet including an IP address

associated with a domain name in operation S320. When there are multiple IP addresses corresponding to the domain name, the response IP packet may include an IP address of a server closest to the terminal is transmitted to the terminal.

[56] A mobile communication network may include edge servers 305a to 305h to provide CDN services, as well as a DNS server 303. The edge servers provide fast network services to users and reduce the load of network. For example, when a network has one DNS server, the network load increases and the quality of services to users decreases. These problems can be resolved by installing a number of edge servers in the network.

[57] Therefore, the DNS server 303 is capable of allocating an edge server, which is closest to a terminal, to the terminal, from among the IP addresses corresponding to the received domain name.

[58] In order to allocate an edge server closest to a terminal to the terminal, the DNS server 303 is capable of determining an edge server closest to a terminal, based on an IP address of the terminal included in the received IP packet, and IP bandwidths assigned to Internet service providers (ISPs), and allocating the edge server to the terminal.

[59] When the DNS server 303 is implemented with a number of DNS servers and the DNS server 303 that received an IP packet has not stored the IP address corresponding to the domain name, the DNS server 303 may transmit the received IP packet to another DNS server. The DNS server 303 may also transmit information that can derive information included in the IP packet.

[60] When the DNS server 303 transmits the response IP packet to the terminal 301, the terminal 301 is capable of accessing the edge server using the IP address included in the response IP packet in operation S330. The edge server 305h that is allocated to the terminal 301 is then capable of providing content to the terminal in operation S340.

[61] FIG. 4 is a flow diagram illustrating a method for providing content to a terminal by using a DNS server and an edge server according to an embodiment of the present disclosure.

[62] Referring to FIG. 4, the terminal 401 is capable of receiving a user input in operation S410. The user input may include a domain name to access a particular server and to receive content therefrom.

[63] The terminal 401 transmits an IP packet including the domain name to a DNS server 403 in operation S420.

[64] The IP packet transmitted to the DNS server 403 may include the IP address of the terminal 401, and the IP address of a destination to receive the IP packet, as well as the user's input domain name.

[65] The IP packet is transmitted from the terminal 401 to the DNS server 403 corresponding to the IP address of a destination.

- [66] The DNS server 403 receives the IP packet and creates the response IP packet for the received IP packet in operation S430.
- [67] The DNS server 403 searches for an IP address corresponding to the domain name included in the received IP packet. The DNS server 403 may have stored an IP address corresponding to the domain name. The DNS server 403 may search for an IP address corresponding to the received domain name by the IP information.
- [68] The DNS server 403 is capable of determining an edge server closest to a user based on an IP address of the terminal that transmitted the IP packet and the IP bandwidths allocated according to ISPs.
- [69] Therefore, the DNS server 403 may include an IP address, which corresponds to an edge server closest to a user, in the response IP packet.
- [70] The DNS server 403 creates the response IP packet and transmits the created response IP packet to the terminal 401 in operation S440.
- [71] The terminal 401 receives the response IP packet and accesses the edge server according to the IP address included in the IP packet to receive corresponding content therefrom in operation S450.
- [72] FIG. 5 is a diagram that illustrates a problem when a server is installed to a cell site according to an embodiment of the present disclosure.
- [73] Referring to FIG. 5, according to an embodiment of the present disclosure, a server is installed in a cell site to provide fast network services and to reduce the network load. As a server is installed closer to a terminal than to an edge server, fast services can be provided to the user.
- [74] When servers are installed in a cell site (which are referred to as cell site servers), the DNS server 503 cannot distinguish between a cell site server closest to a user (called a proximity server) from other cell site servers.
- [75] For example, when a terminal 501a needs to receive a service, the DNS server 503 must allocate an IP address of a cell site server 505a, closest to the terminal 501a, to the terminal 501a.
- [76] However, since the DNS server 503 can detect only an edge server closest to a user based on the IP address of the terminal, which is included in the IP packet transmitted by the user, and the IP bandwidths allocated according to ISPs, the DNS server 503 cannot search for a cell site server closest to a terminal by using the information.
- [77] The following description provides a method for a DNS server to search for a cell site server closest to a user.
- [78] FIG. 7 is a diagram that illustrates a method for allocating a proximity server to a terminal using a location-information transmitting apparatus according to an embodiment of the present disclosure.
- [79] As described above, the proximity server refers to a server closest to a user from

among the servers installed in a cell site.

[80] Referring to FIG. 7, a user inputs a domain name into a terminal 701 to access a particular site.

[81] The terminal 701 transmits an IP packet including a DNS query to the DNS server 703 in operation S710. The location-information transmitting apparatus 705 is capable of obtaining (or intercepting) the IP packet transmitted by the terminal 701. The location-information transmitting apparatus 705 may be installed in the path for transmitting IP packets and is capable of obtaining an IP packet from the path.

[82] The terminal 701 is capable of transmitting IP packets to the location-information transmitting apparatus 705.

[83] When obtaining an IP packet, the location-information transmitting apparatus 705 includes terminal location information in the IP packet and transmits the IP packet to the DNS server 503 in operation S720. That is, the location-information transmitting apparatus 705 injects the terminal location information into the IP packet and re-transmits the packet.

[84] After receiving the IP packet including the terminal location information, the DNS server 703 is capable of searching for the IP address of a server corresponding to the domain name included in the IP packet. The DNS server 703 also searches for a proximity server closest to a user from among the servers corresponding to the domain name, by using the terminal location information.

[85] Therefore, the DNS server 703 is capable of transmitting, to the terminal, the response IP packet including the IP address of the proximity server in operation S730.

[86] After receiving the response IP packet, the terminal 701 is capable of accessing the proximity server by using the IP address included in the response IP packet in operation S740. The proximity server is capable of providing content to the terminal 701 in operation S750.

[87] FIG. 8 is a diagram that illustrates a method for allocating a proximity server according to an embodiment of the present disclosure.

[88] Referring to FIG. 8, a user inputs a domain name into a terminal 801a to access a particular site. After receiving the domain name, the terminal 801a transmits the IP packet including a DNS query to the DNS server 803 in operation S810. When the terminal 801a transmits the IP packet to the DNS server 803, the location-information transmitting apparatus 805 is capable of obtaining the IP packet from the terminal.

[89] The terminal 801a is also capable of transmitting the IP packet including a DNS query to the location-information transmitting apparatus 805.

[90] For example, to access the website of the Korean Intellectual Patent Office, the user inputs www.kipo.go.kr to the terminal. When the terminal receives the domain name, the domain name is included in the DNS query of the IP packet and then transmitted.

The domain name may also be included in another part of the IP packet and then transmitted.

- [91] The location-information transmitting apparatus 805 transmits terminal location information to a DNS server so that the DNS server 803 can allocate a proximity server to a user. The location-information transmitting apparatus 805 may be installed in a network entity in an IP packet transmission path.
- [92] IP packets may be transmitted from a base station to the DNS server via network entities such as a router, a gateway, etc. Therefore, the location-information transmitting apparatus 805 may be installed in a base station, a router, a gateway, etc.
- [93] The location-information transmitting apparatus 805 may be installed, in the form of software such as a module, into one of the network entities located on a path transmitting IP packets. The location-information transmitting apparatus 805 may be implemented in the form of hardware to be installed to a path transmitting IP packets.
- [94] After obtaining an IP packet, the location-information transmitting apparatus 805 is capable of inserting terminal location information into the IP packet in operation S810.
- [95] The terminal location information may include a cell identifier where a terminal is located, a base station identifier of a cell where a terminal is located, a latitude and a longitude of where a terminal is located, etc. The terminal location information may also include an IP address of a proximity server, a cell site location-information, geographical location information of a terminal, identifiers of the location information, etc. The terminal location information may be created by the location-information transmitting apparatus 805 or received from a network entity.
- [96] The location-information transmitting apparatus 805 may insert the terminal location-information into part of the IP packet. For example, the location-information transmitting apparatus 805 may insert the terminal location information into the IP header of the IP packet, the UDP header, or the DNS message part.
- [97] When the terminal location information is inserted into the IP packet, the location-information transmitting apparatus 805 is capable of transmitting the IP packet including the terminal location information to the DNS server 803 in operation S820.
- [98] After receiving the IP packet including the terminal location information, the DNS server 803 is capable of transmitting, to the user, the response IP packet including the DNS response in operation S830.
- [99] The IP packet transmitted by the DNS server 803 may include an IP address of a proximity server as a cell site server closest to a user. The DNS server 803 searches for a proximity server by using the terminal location information included in the received IP packet, and creates the response IP packet including the IP address of the proximity server to transmit the created response.
- [100] For example, as shown in FIG. 8, when a user 801b needs to access a website,

www.example.com, a server of the website may include cell site servers 807a and cell site server 807b. Since the proximity server of the terminal 801 is a cell site server 807a has an IP address of 20.20.20.2, the response IP packet may include an IP address, 20.20.20.2.

- [101] When the DNS server 803 transmits the response IP packet to the terminal in operation S830, the response IP packet may be transmitted to the terminal via a router, a base station, etc.
- [102] After receiving the response IP packet, the terminal may access a proximity server by using the IP address of the proximity server included the received response IP packet in operation S840. The proximity server is capable of providing content to the terminal in operation S850.
- [103] The location-information transmitting apparatus 805 is capable of allocation of the IP address of a proximity server to the terminal without participation of the DNS server. That is, when the location-information transmitting apparatus 805 receives the terminal location information including an IP address of a proximity server, the location-information transmitting apparatus 805 is capable of directly allocating the IP address of a proximity server to the terminal.
- [104] When the location-information transmitting apparatus 805 receives the terminal location information including an IP address of a proximity server, the location-information transmitting apparatus 805 is capable of transmitting the IP address of a proximity server to the DNS server 803 in operation S820. After receiving the IP address of a proximity server closest to the terminal, the DNS server 803 is capable of allocating the proximity server to the terminal by using the IP address of the proximity server.
- [105] When the terminal receives content via the proximity server, the service provider can reduce the load of network and the user can receive a high quality of service.
- [106] FIG. 9 is a flow diagram that illustrates a method for allocating a proximity server according to an embodiment of the present disclosure.
- [107] Referring to FIG. 9, the terminal 901 is capable of receiving a user input in operation S910.
- [108] After receiving the user input, the terminal 901 transmits an IP packet to the location-information transmitting apparatus 905 in operation S920. When the terminal 901 transmits IP packet to the DNS server 903, the location-information transmitting apparatus 905 obtains the IP packet in operation S920 as described above.
- [109] The location-information transmitting apparatus 905 inserts the terminal location information into the received IP packet in operation S930.
- [110] The terminal location information may include a cell identifier where a user is located, a base station identifier of a cell where a user is located, a latitude and a

longitude of where a user is located, etc. The terminal location information may be directly created by the location-information transmitting apparatus 905 or received from a network entity.

- [111] When the location-information transmitting apparatus 905 inserts the terminal location information into an IP packet, it is capable of transmitting the IP packet to the DNS server 903 in operation S940.
- [112] The DNS server 903 receives the IP packet and creates the response IP packet to be transmitted to the terminal 901 in operation S950.
- [113] When the DNS server 903 creates the response IP packet, it is capable of searching for an IP address of a proximity server by using the terminal location information and the domain name included in the IP packet, and inserting the IP address of the proximity server into the response IP packet.
- [114] The DNS server 903 is also capable of searching for an IP address of a server corresponding to a domain name via the domain name included in the IP packet and an address of a server closest to a terminal from among the IP addresses corresponding to the domain name by using the terminal location information, and inserting the IP address of a server closest to the terminal to the response IP packet.
- [115] The response IP packet created by the DNS server 903 may include a DNS response, an IP address of a proximity server, etc.
- [116] After that, the DNS server 903 transmits the response IP packet to the terminal 901 in operation S960.
- [117] After receiving the response IP packet, the terminal 901 is capable of accessing the proximity server via the IP address included in the response IP packet and receiving content from the proximity server.
- [118] FIG. 10 is a diagram that illustrates a method for transmitting video to a server via a location-information transmitting apparatus according to an embodiment of the present disclosure.
- [119] Referring to FIG. 10, video may be captured by a closed circuit television (CCTV) 1001 that is installed to a specific place for observing or monitoring a state or event such as traffic information, etc. Videos taken by a CCTV camera 1001 need to be stored in a CCTV server for a certain period of time. To this end, a CCTV camera transmits the respective taken videos to the CCTV server. In this case, the transmission of the CCTV videos to the server may employ the features of the present disclosure.
- [120] When CCTV cameras are installed and the CCTV videos are stored in a DNS server 1003, the videos may reduce storage capacity in the DNS server 1003 and may also lower the transmission speed to the DNS server 1003. Accordingly, the system is configured in such a way that a number of servers may be installed into a cell site and a CCTV camera transmits the video to a cell site server closest to the CCTV camera.

- [121] In order to transmit videos taken by a CCTV camera to a server, an administrator inputs, to the terminal, a domain name, e.g., cctv.example.com.
- [122] After receiving the user's input, the terminal is capable of transmitting an IP packet including a DNS query to the location-information transmitting apparatus 1005 in operation S1010. The IP packet may include the domain name.
- [123] The location-information transmitting apparatus 1005 is capable of inserting the CCTV camera location information into the IP packet. Since the embodiment is implemented in such a way that the CCTV camera is fixed, the CCTV camera serving as a terminal inserts the location information into the IP packet and transmits the IP packet to the DNS server 1003.
- [124] The CCTV location information or the terminal or location information may be inserted into part of the IP packet.
- [125] When the location-information transmitting apparatus 1005 inserts the terminal location information into an IP packet, the location-information transmitting apparatus 1005 is capable of transmitting the IP packet to the DNS server 1003 in operation S1020.
- [126] When receiving the IP packet, the DNS server 1003 is capable of creating the response IP packet to be transmitted to the terminal. The response IP packet may include a DNS response and an IP address of a proximity server. The DNS server 1003 searches for a proximity server by using the terminal location information included in the received IP packet, and then creates a response IP packet including the IP address of the proximity server.
- [127] The DNS server 1003 transmits the response IP packet to the terminal in operation S1030.
- [128] The terminal is capable of accessing a proximity server corresponding to the IP address included in the response IP packet in operation S1040. The terminal accesses the proximity server and uploads the CCTV video on the proximity server in operation S1050. The proximity server may transmit the uploaded video to a CCTV center for managing videos transmitted from CCTV cameras. The proximity server may also download a video from the CCTV server to provide the video to users.
- [129] As described above, the present disclosure is capable of allocating a proximity server to a terminal by using the terminal location information so that the terminal user can receive services from the proximity server. Therefore, the present disclosure is capable of providing the terminal user with a high quality of communication service and reducing the network load.
- [130] While the present disclosure has been shown and described with reference to various embodiments thereof, it will be understood by those skilled in the art that various changes in form and details may be made therein without departing from the spirit and

scope of the present disclosure as defined by the appended claims and their equivalents.

## Claims

- [Claim 1] An apparatus for allocating a server to a terminal, the apparatus comprising:  
a communication unit configured to communicate with other network entities; and  
a controller configured to:  
receive an Internet protocol (IP) packet with a domain name system (DNS) query from the terminal,  
include terminal location information in the IP packet,  
transmit the IP packet to a DNS server,  
receive, from the DNS server, a response IP packet with location information of a proximity server, the proximity server being located within a certain distance from the terminal, and  
transmit the response IP packet to the terminal.
- [Claim 2] The apparatus of claim 1, wherein the location information of the proximity server is used for the terminal to access the proximity server.
- [Claim 3] The apparatus of claim 1, wherein the apparatus is installed to one of the network entities located on a path transmitting the IP packet.
- [Claim 4] The apparatus of claim 1, wherein the controller is further configured to:  
include the terminal location information in an IP header of the IP packet, a user datagram protocol (UDP) header, transmission control protocol (TCP), or a DNS message part, and  
control transmission of the IP packet.
- [Claim 5] The apparatus of claim 1, wherein the DNS server comprises a number of DNS servers, and  
wherein the IP packet comprises information corresponding to the terminal location information or information to generate the terminal location information to be transmitted to another DNS server via the DNS server.
- [Claim 6] The apparatus of claim 1, wherein the location information of the proximity server comprises:  
an IP address of the proximity server.
- [Claim 7] The apparatus of claim 1, wherein the terminal location information comprises at least one of an IP address of the proximity server, a cell site location information, geographical location information of the terminal, and identifiers of the terminal location information.

- [Claim 8] A domain name system (DNS) server for allocating a server to a terminal, the DNS server comprising:  
a communication unit configured to communicate with other network entities; and  
a controller configured to:  
control the communication unit to receive an Internet protocol (IP) packet with terminal location information from a location-information transmitting apparatus, and  
control the communication unit to transmit, to a location-information transmitting apparatus, a response IP packet with location information of a proximity server based on the terminal location information, the proximity server being located within a certain distance from the terminal.
- [Claim 9] The DNS server of claim 8, wherein the location information of the proximity server is used for the terminal to access the proximity server.
- [Claim 10] The DNS server of claim 8, wherein the location-information transmitting apparatus is installed to one of the network entities located on a path transmitting the IP packet.
- [Claim 11] The DNS server of claim 8, wherein the terminal location information is included in an IP header of the received IP packet, a user datagram protocol (UDP) header, transmission control protocol (TCP), or a DNS message part.
- [Claim 12] The DNS server of claim 8, wherein:  
the DNS server comprises a number of DNS servers; and  
the IP packet comprises information corresponding to the terminal location information or information to generate the terminal location information to be transmitted to another DNS server via the DNS server.
- [Claim 13] The DNS server of claim 8, wherein the location information of the proximity server comprises:  
an IP address of the proximity server.
- [Claim 14] The DNS server of claim 8, wherein the terminal location information comprises at least one an IP address of the proximity server, a cell site location information, geographical location information of the terminal, and identifiers of the terminal location information.
- [Claim 15] A method for a location-information transmitting apparatus to allocate a server to a terminal, the method comprising:  
receiving an Internet protocol (IP) packet with a domain name system (DNS) query from the terminal;

- including terminal location information in the IP packet;  
transmitting the IP packet to a DNS server; and  
receiving, from the DNS server, a response IP packet with location information of a proximity server, the proximity server being located within a certain distance from the terminal; and  
transmitting the response IP packet to the terminal.
- [Claim 16] The method of claim 15, wherein the location information of the proximity server is used for the terminal to access the proximity server.
- [Claim 17] The method of claim 15, wherein the location information transmitting apparatus is installed to one of the network entities located on a path transmitting the IP packet.
- [Claim 18] The method of claim 15, further comprising:  
including the terminal location information in an IP header of the IP packet, a user datagram protocol (UDP) header, transmission control protocol (TCP), or a DNS message part; and  
transmitting the IP packet.
- [Claim 19] The method of claim 15, wherein:  
the DNS server comprises a number of DNS servers; and  
the IP packet comprises information corresponding to the terminal location information or information to generate the terminal location information regarding the terminal to be transmitted to another DNS server via the DNS server.
- [Claim 20] The method of claim 15, wherein the location information of the proximity server comprises:  
an IP address of the proximity server.
- [Claim 21] The method of claim 15, wherein the terminal location information comprises at least one of an IP address of the proximity server, cell site location information, geographical location information of the terminal, and identifiers of the terminal location information.
- [Claim 22] A method for a domain name system (DNS) server to allocate a server to a terminal, the method comprising:  
receiving an Internet protocol (IP) packet with terminal location information from a location-information transmitting apparatus; and  
transmitting, to the location-information transmitting apparatus, a response IP packet with location information of a proximity server based on the terminal location information, the proximity server being located within a certain distance from the terminal.
- [Claim 23] The method of claim 22, wherein the location information of the

proximity server is transmitted to the terminal and used to connect the terminal and the proximity server.

[Claim 24] The method of claim 22, wherein the location-information transmitting apparatus is installed to one of the network entities located on a path transmitting the IP packet.

[Claim 25] The method of claim 22, further comprising:  
including the terminal location information in an IP header of the IP packet, a user datagram protocol (UDP) header, transmission control protocol (TCP), or a DNS message part; and transmitting the IP packet.

[Claim 26] The method of claim 22, wherein:  
the DNS server comprises a number of DNS servers; and  
the IP packet comprises information corresponding to the terminal location information or information to generate the terminal location information to be transmitted to another DNS server via the DNS server.

[Claim 27] The method of claim 22, wherein the location information of the proximity server comprises:  
an IP address of the proximity server.

[Claim 28] The method of claim 22, wherein the terminal location information comprises at least one of an IP address of the proximity server, cell site location information, geographical location information of the terminal, and identifiers of the terminal location information.

[Fig. 1]

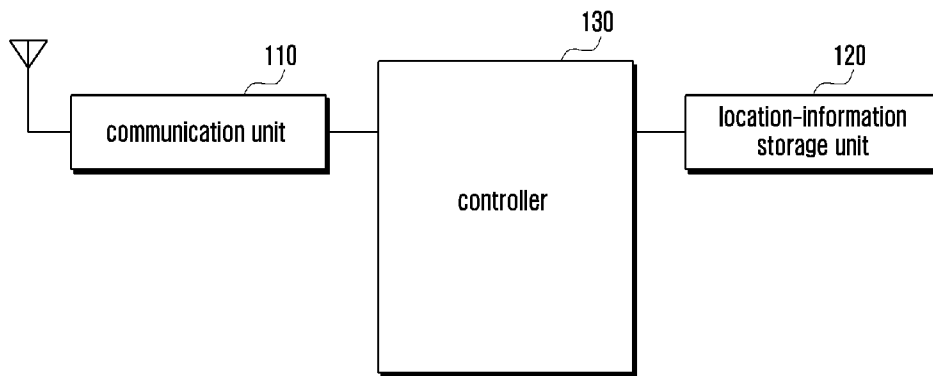

[Fig. 2]

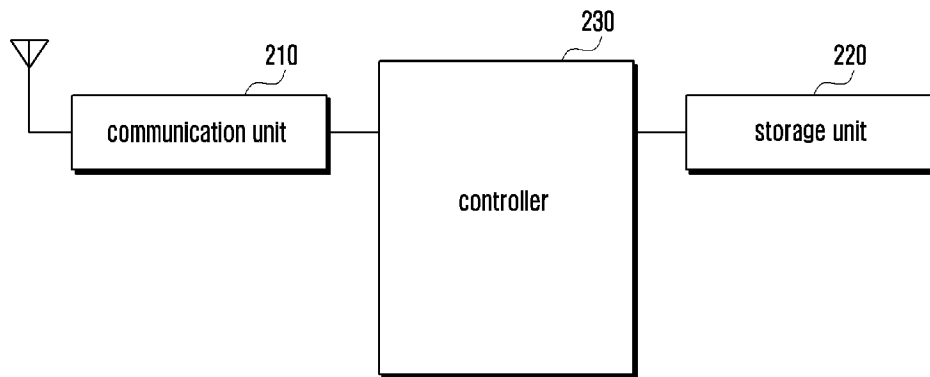

[Fig. 3]

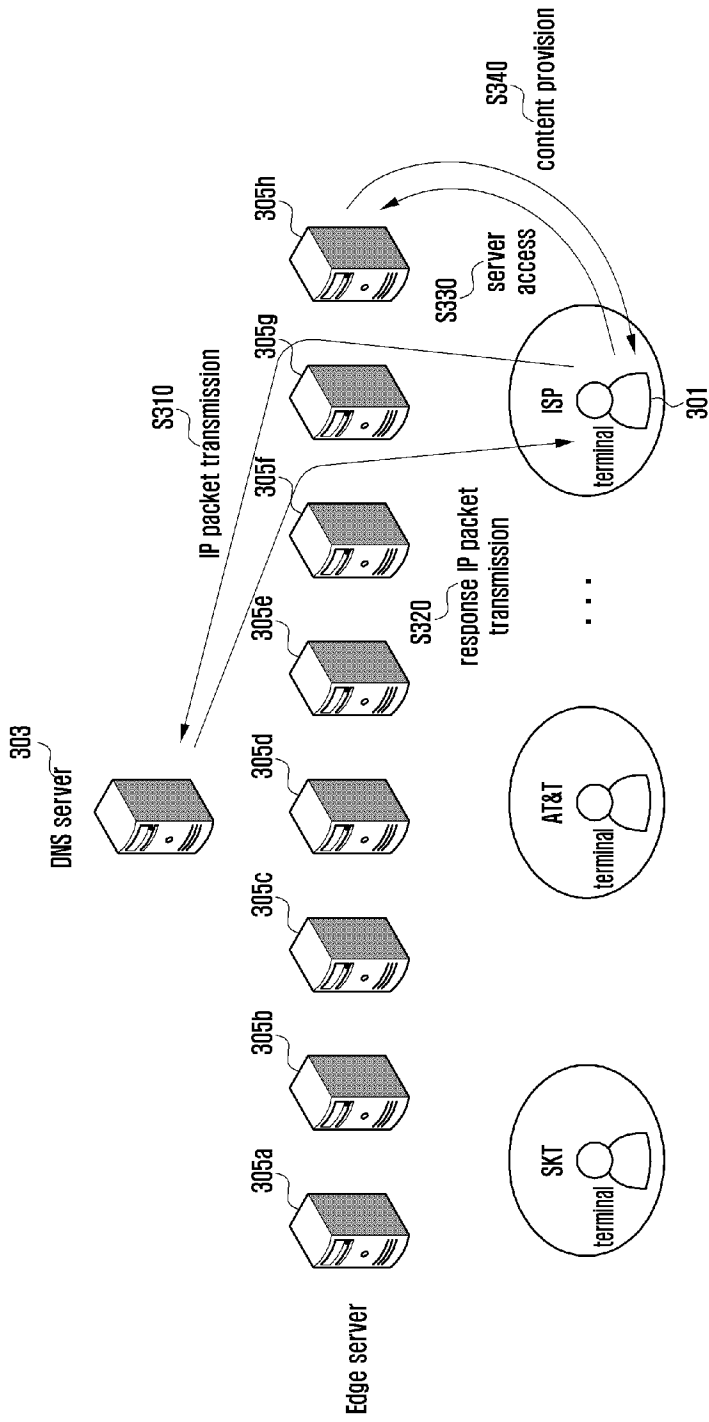

[Fig. 4]

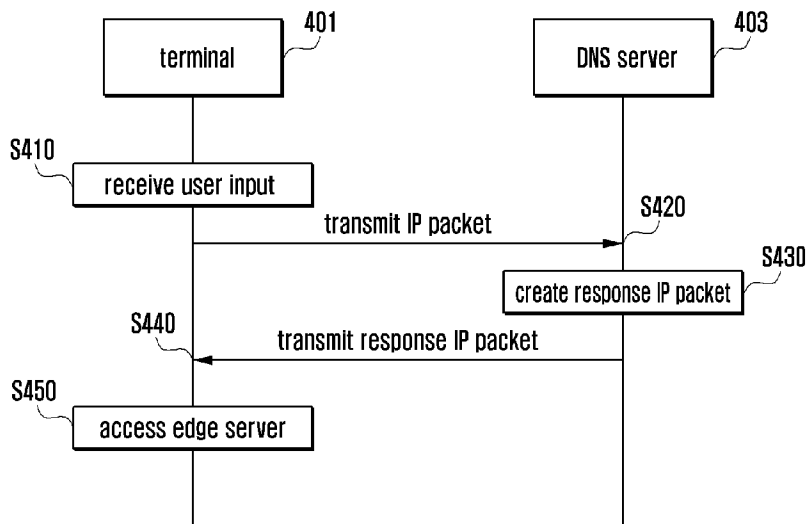

[Fig. 5]

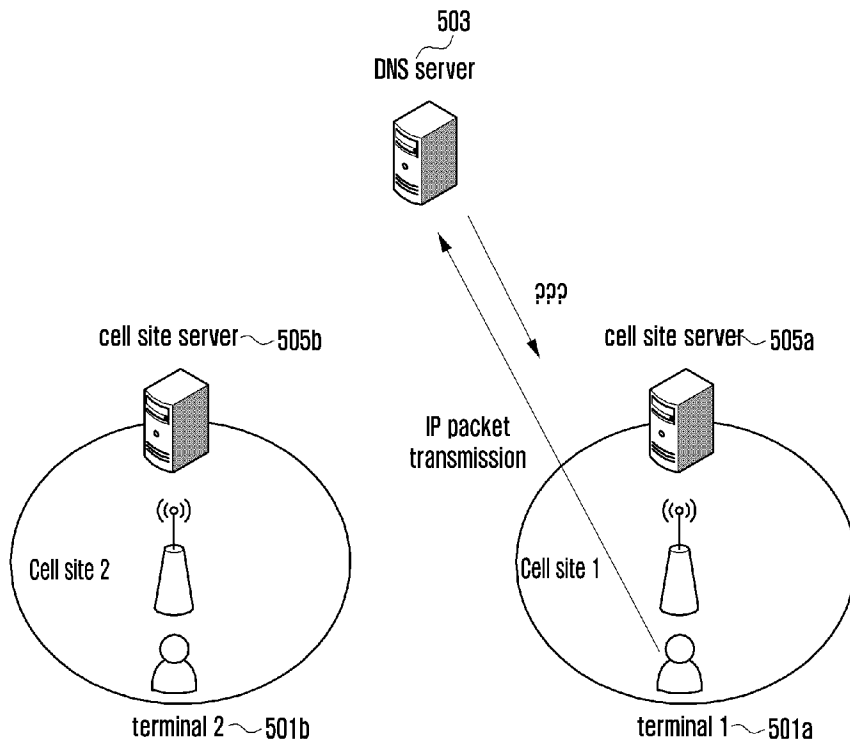

[Fig. 6]

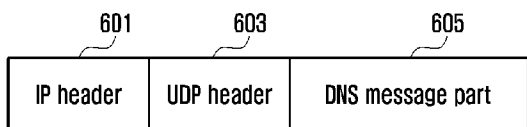

[Fig. 7]

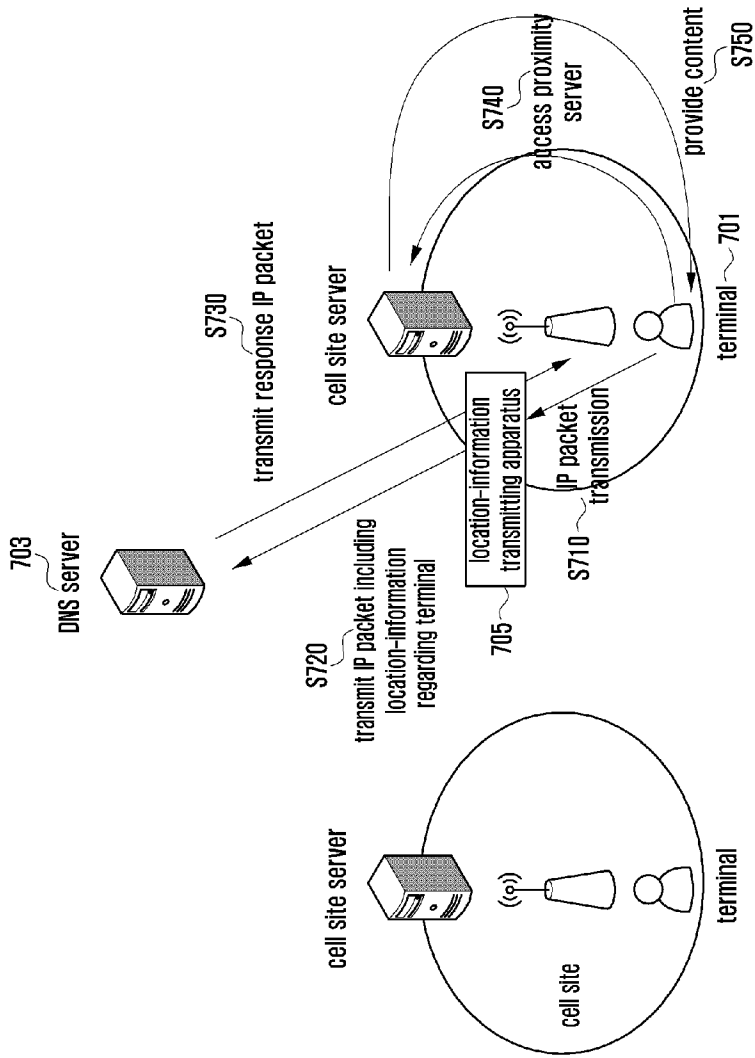

[Fig. 8]

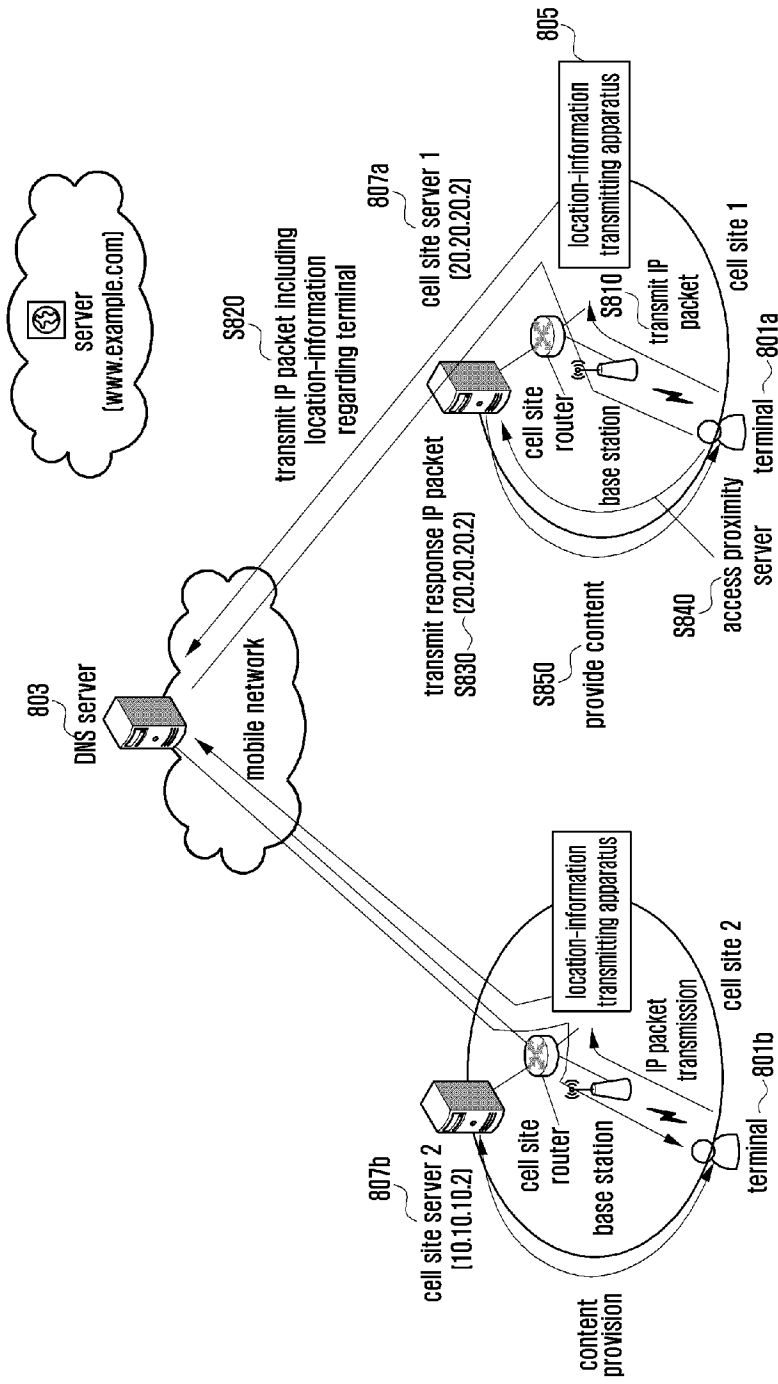

[Fig. 9]

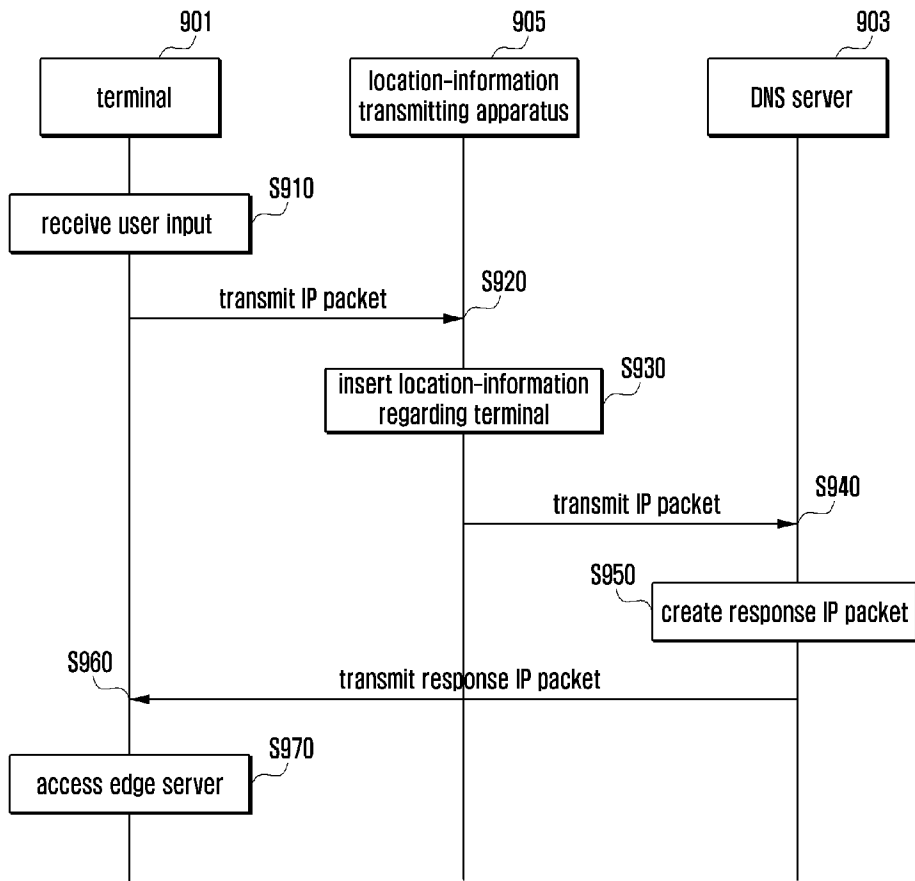

[Fig. 10]

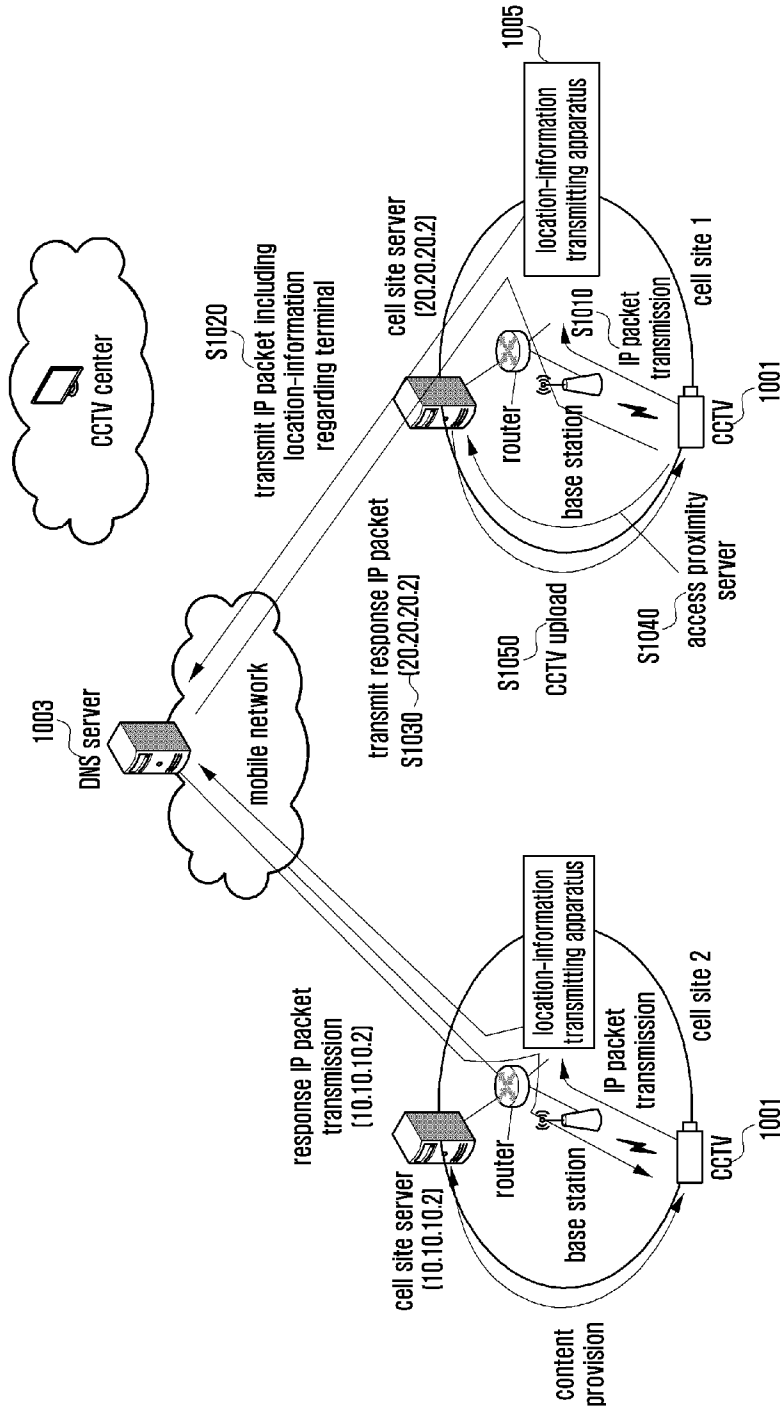

**A. CLASSIFICATION OF SUBJECT MATTER****H04L 29/08(2006.01)i**

According to International Patent Classification (IPC) or to both national classification and IPC

**B. FIELDS SEARCHED**Minimum documentation searched (classification system followed by classification symbols)  
H04L 29/08; G06F 15/16; H04W 8/02; G06F 17/30; H04L 12/26; H04L 12/56Documentation searched other than minimum documentation to the extent that such documents are included in the fields searched  
Korean utility models and applications for utility models  
Japanese utility models and applications for utility modelsElectronic data base consulted during the international search (name of data base and, where practicable, search terms used)  
eKOMPASS(KIPO internal) & keywords: allocate, server, DNS, location**C. DOCUMENTS CONSIDERED TO BE RELEVANT**

Category*	Citation of document, with indication, where appropriate, of the relevant passages	Relevant to claim No.
Y	US 2012-0196601 A1 (HENRIK LUNDQVIST et al.) 02 August 2012 See paragraphs [0083], [0105]; claims 11, 13; and figure 1.	1-28
Y	US 2013-0297596 A1 (EVERBRIDGE, INC.) 07 November 2013 See paragraph [0016]; claims 1, 2; and figures 3-5.	1-28
A	US 2013-0198387 A1 (ERIC SVEN-JOHAN SWILDENS et al.) 01 August 2013 See paragraphs [0066]-[0069]; claims 10-17; and figure 4.	1-28
A	US 2008-0086574 A1 (NATHAN F. RACIBORSKI et al.) 10 April 2008 See abstract; paragraphs [0045]-[0056]; and figures 3A-4C.	1-28
A	US 2007-0177499 A1 (ALEXANDRU GAVRILESCU et al.) 02 August 2007 See abstract; claims 1-17; and figures 2, 3.	1-28

 Further documents are listed in the continuation of Box C. See patent family annex.

\* Special categories of cited documents:

"A" document defining the general state of the art which is not considered to be of particular relevance

"E" earlier application or patent but published on or after the international filing date

"L" document which may throw doubts on priority claim(s) or which is cited to establish the publication date of another citation or other special reason (as specified)

"O" document referring to an oral disclosure, use, exhibition or other means

"P" document published prior to the international filing date but later than the priority date claimed

"T" later document published after the international filing date or priority date and not in conflict with the application but cited to understand the principle or theory underlying the invention

"X" document of particular relevance; the claimed invention cannot be considered novel or cannot be considered to involve an inventive step when the document is taken alone

"Y" document of particular relevance; the claimed invention cannot be considered to involve an inventive step when the document is combined with one or more other such documents, such combination being obvious to a person skilled in the art

"&amp;" document member of the same patent family

Date of the actual completion of the international search

28 March 2016 (28.03.2016)

Date of mailing of the international search report

**11 April 2016 (11.04.2016)**

Name and mailing address of the ISA/KR

International Application Division  
Korean Intellectual Property Office  
189 Cheongsa-ro, Seo-gu, Daejeon, 35208, Republic of Korea

Facsimile No. +82-42-481-8578

Authorized officer

KIM, Seong Woo

Telephone No. +82-42-481-3348



**INTERNATIONAL SEARCH REPORT**

Information on patent family members

International application No.

**PCT/KR2015/014212**

Patent document cited in search report	Publication date	Patent family member(s)	Publication date
US 2012-0196601 A1	02/08/2012	CN 102624939 A	01/08/2012
		EP 2482525 A1	01/08/2012
		EP 2482525 B1	12/03/2014
		JP 2012-161078 A	23/08/2012
		JP 5271430 B2	21/08/2013
		KR 10-2012-0087857 A	07/08/2012
		RU 2012102503 A	10/08/2013
		US 8428592 B2	23/04/2013
US 2013-0297596 A1	07/11/2013	EP 2845373 A1	11/03/2015
		WO 2013-165837 A1	07/11/2013
US 2013-0198387 A1	01/08/2013	US 2012-0179814 A1	12/07/2012
		US 2014-0156839 A1	05/06/2014
		US 8341297 B2	25/12/2012
		US 8683079 B2	25/03/2014
US 2008-0086574 A1	10/04/2008	EP 2078258 A2	15/07/2009
		US 2010-0100629 A1	22/04/2010
		US 2011-0302322 A1	08/12/2011
		US 2012-0179839 A1	12/07/2012
		US 2012-0303735 A1	29/11/2012
		US 2013-0297826 A1	07/11/2013
		US 7730187 B2	01/06/2010
		US 8024468 B2	20/09/2011
		US 8117319 B2	14/02/2012
		US 8250219 B2	21/08/2012
		US 8417824 B2	09/04/2013
		US 8769118 B2	01/07/2014
WO 2008-042911 A2	10/04/2008		
WO 2008-042911 A3	16/10/2008		
US 2007-0177499 A1	02/08/2007	US 2007-0177524 A1	02/08/2007
		US 7711800 B2	04/05/2010
		US 8160062 B2	17/04/2012