



US00D427209S

United States Patent [19]

[11] Patent Number: **Des. 427,209**

Collida et al.

[45] Date of Patent: **** Jun. 27, 2000**

[54] STUFFING MACHINE

5,199,244 4/1993 Beier et al. 141/67

[75] Inventors: **Karl Collida**, Lake Saint Louis; **Edwin T. Wood, Jr.**, O'Fallon, both of Mo.

OTHER PUBLICATIONS

Photo of machine used by Assignee Oct. 1997 (far left of page).

[73] Assignee: **Build-A-Bear Workshop, L.L.C.**, St. Louis, Mo.

Primary Examiner—B. J. Bullock
Attorney, Agent, or Firm—Blackwell Sanders Peper Martin

[**] Term: **14 Years**

[57] CLAIM

[21] Appl. No.: **29/094,802**

The ornamental design for a stuffing machine, as shown and described.

[22] Filed: **Oct. 9, 1998**

[51] LOC (7) Cl. **15-06**

[52] U.S. Cl. **D15/66**

[58] Field of Search D15/66; 141/67;
19/305, 85; 406/173

DESCRIPTION

FIG. 1 is a perspective view of a stuffing machine showing our new design;

FIG. 2 is a top plan view thereof;

FIG. 3 a front elevational view thereof;

FIG. 4 is a right side elevational view thereof;

FIG. 5 a back elevational view thereof; and,

FIG. 6 is a left side elevational view thereof.

Throughout the several views of the drawings lines shown in phantom are for purposes of illustration only and form no part of the claimed design.

[56] References Cited

U.S. PATENT DOCUMENTS

2,794,454	6/1957	Moulthrop .	
3,351,106	11/1967	Moulthrop .	
3,693,836	9/1972	Eisner	141/67
4,664,160	5/1987	Rothstein et al. .	
5,103,879	4/1992	Hickerson	141/67

1 Claim, 3 Drawing Sheets

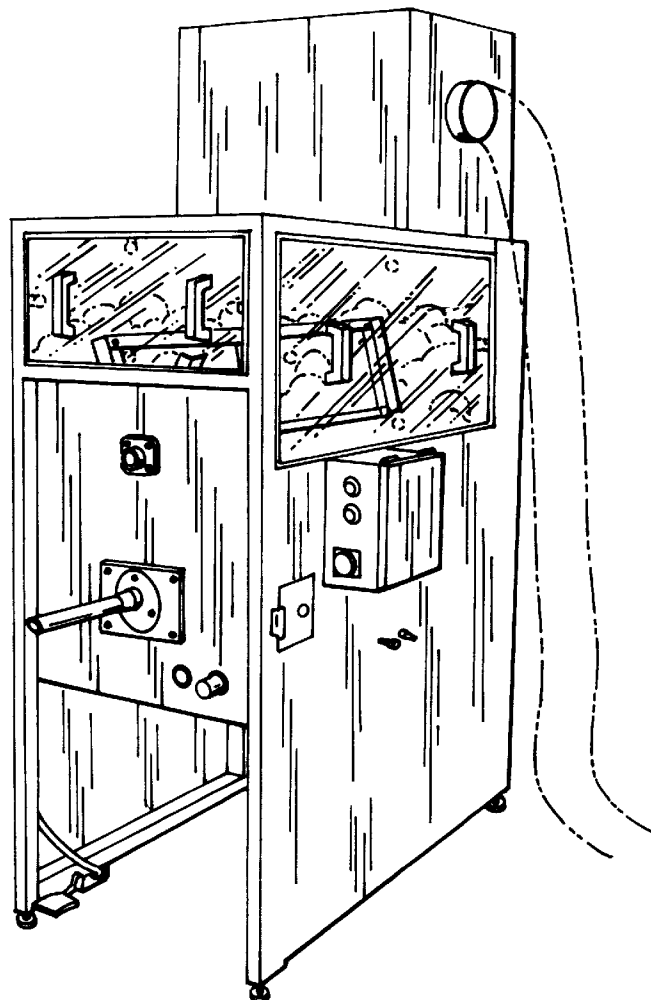

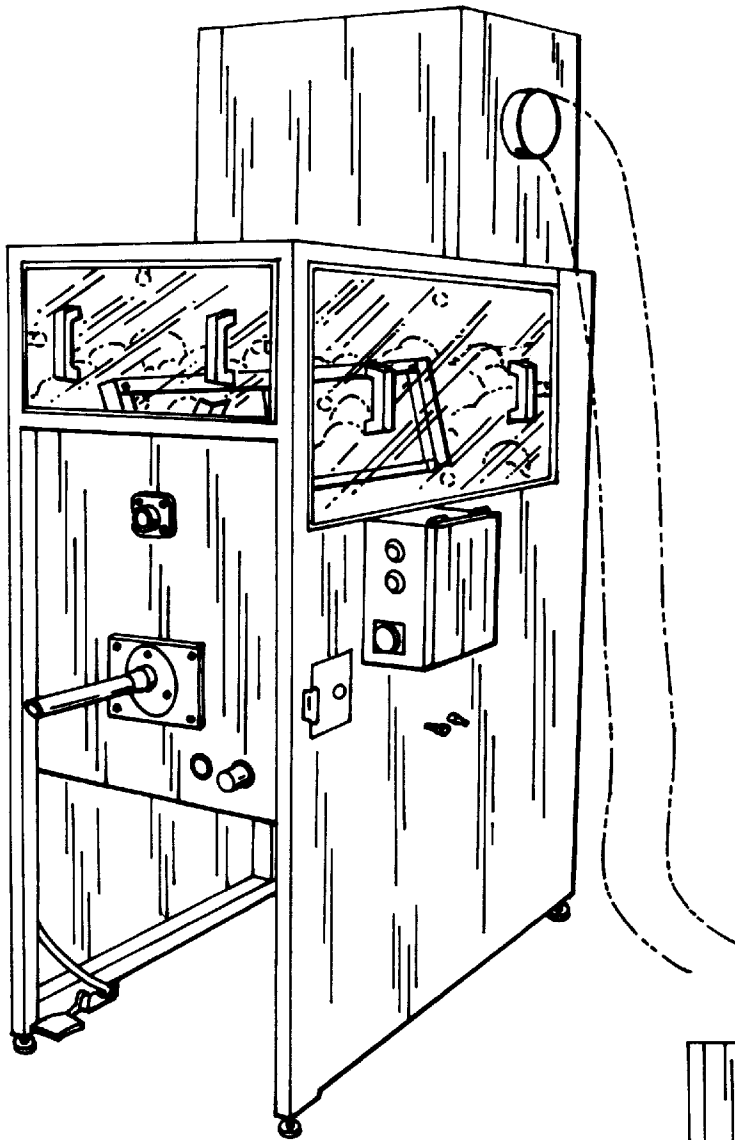

FIG. 1

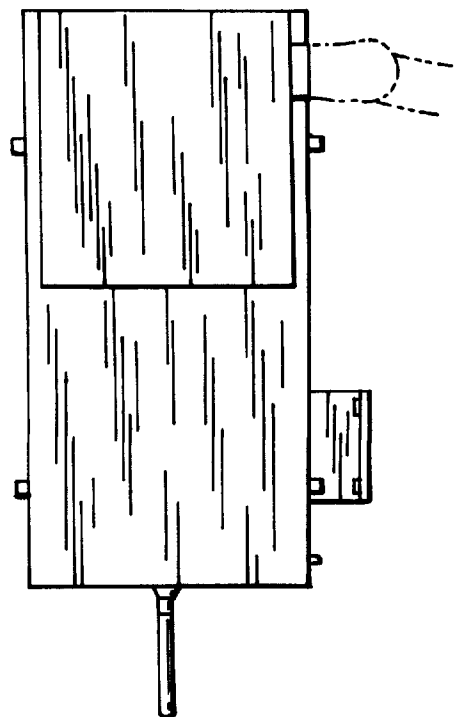

FIG. 2

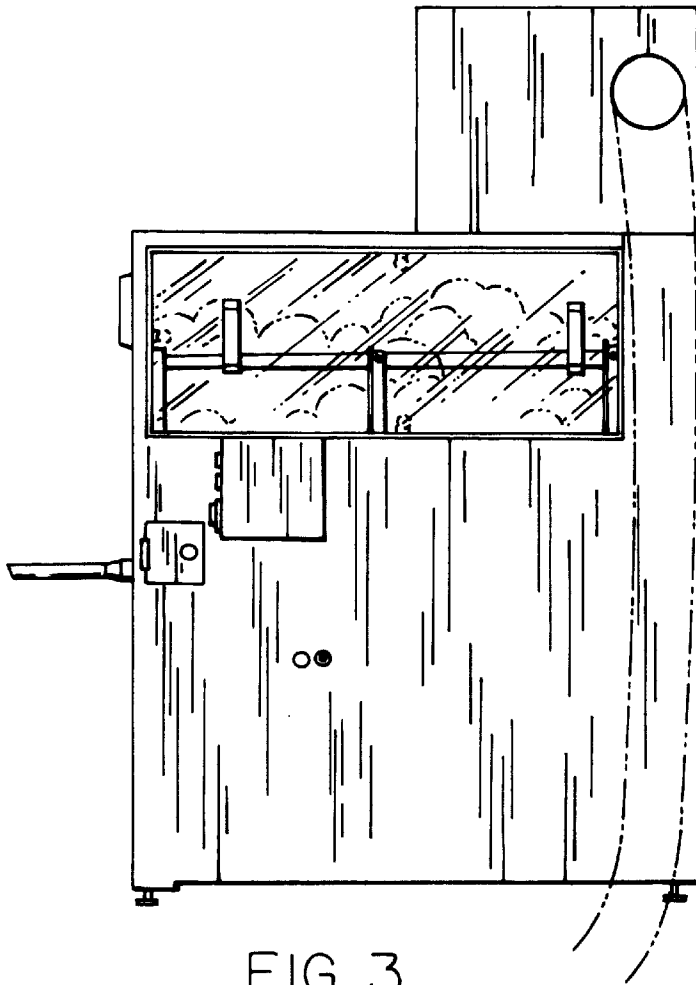

FIG. 3

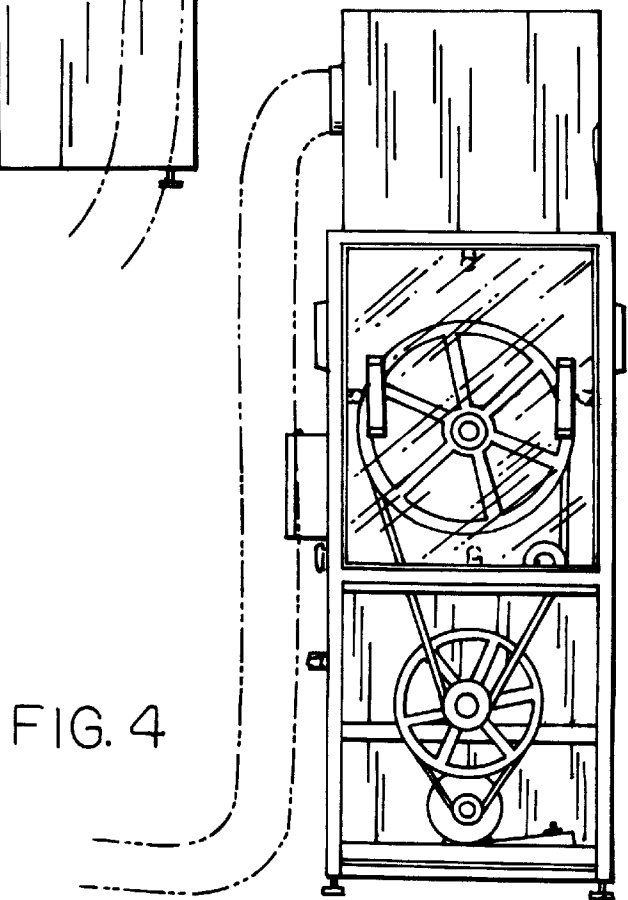

FIG. 4

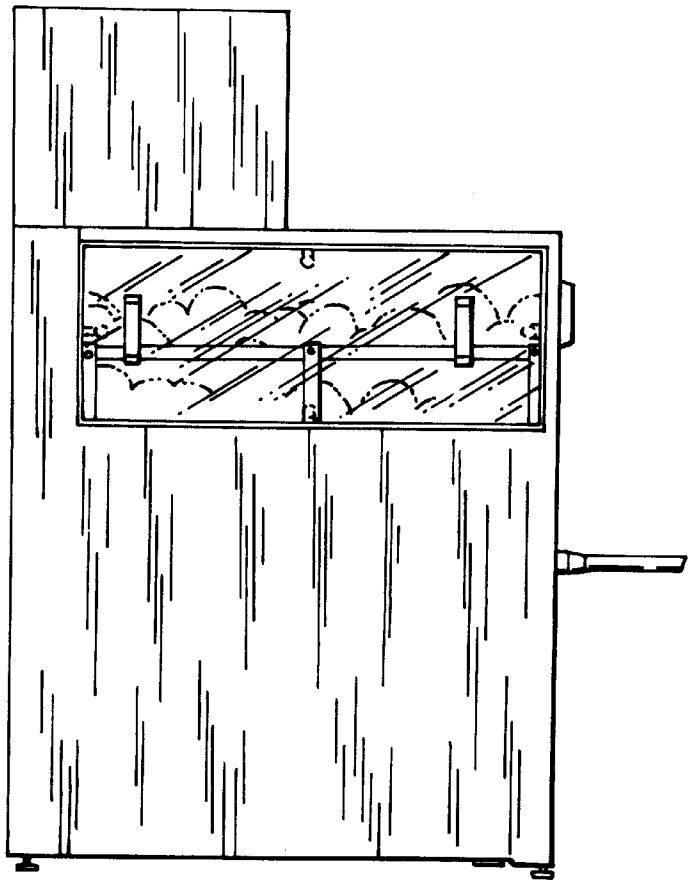

FIG. 5

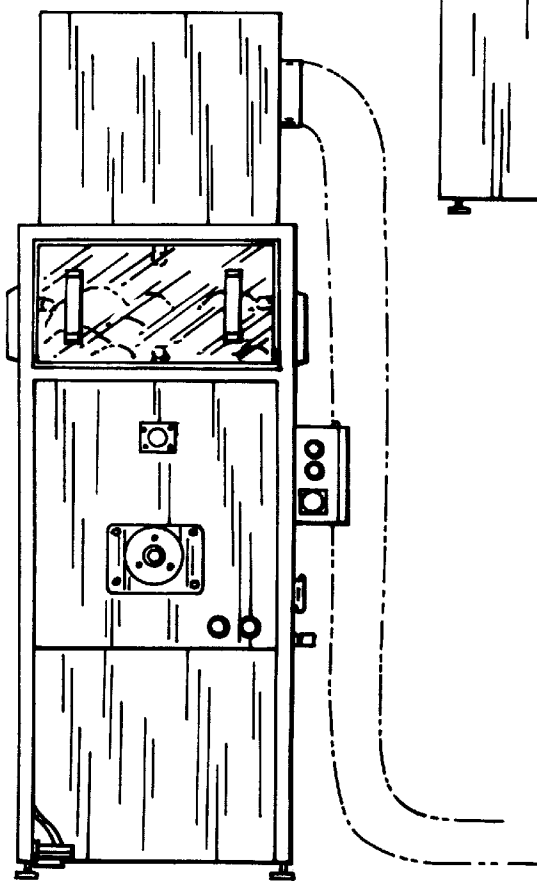

FIG. 6