



US00D658915S

(12) **United States Design Patent**  
**Fernandes et al.**

(10) **Patent No.:** **US D658,915 S**

(45) **Date of Patent:** **\*\* May 8, 2012**

(54) **REFILL CONTAINER FOR A DISPENSING DEVICE**

(75) Inventors: **Mark Fernandes**, Warwick (GB); **Peter Kay**, Warwick (GB); **Andrew Mitchell**, Warwick (GB); **Stephanie Ann Marije Verschoor**, Brentford (GB)

(73) Assignee: **Reckitt Benckiser LLC**, Parsippany, NJ (US)

(\*\*) Term: **14 Years**

(21) Appl. No.: **29/390,389**

(22) Filed: **Apr. 25, 2011**

(30) **Foreign Application Priority Data**

Oct. 26, 2010 (EM) ..... 001772898-0003

(51) **LOC (9) Cl.** ..... **23-02**

(52) **U.S. Cl.** ..... **D6/542**

(58) **Field of Classification Search** ..... D6/542, D6/545; D9/600, 652, 667, 695-697, 702, D9/707-711, 723, 729-733, 516, 520-521, D9/547, 551; 206/457, 822; 215/230, 400; 220/890

See application file for complete search history.

(56) **References Cited**

U.S. PATENT DOCUMENTS

D353,325 S *	12/1994	Chura et al. ....	D9/695
D427,073 S *	6/2000	Gaffney et al. ....	D9/520
D542,661 S *	5/2007	Adler et al. ....	D9/521
D543,752 S *	6/2007	Jones, Sr. ....	D6/545
D583,242 S *	12/2008	Adler et al. ....	D9/516
D612,741 S *	3/2010	Miksovsky ....	D6/542

\* cited by examiner

*Primary Examiner* — Brian N. Vinson

(74) *Attorney, Agent, or Firm* — Ryan A. Schneider; Troutman Sanders LLP

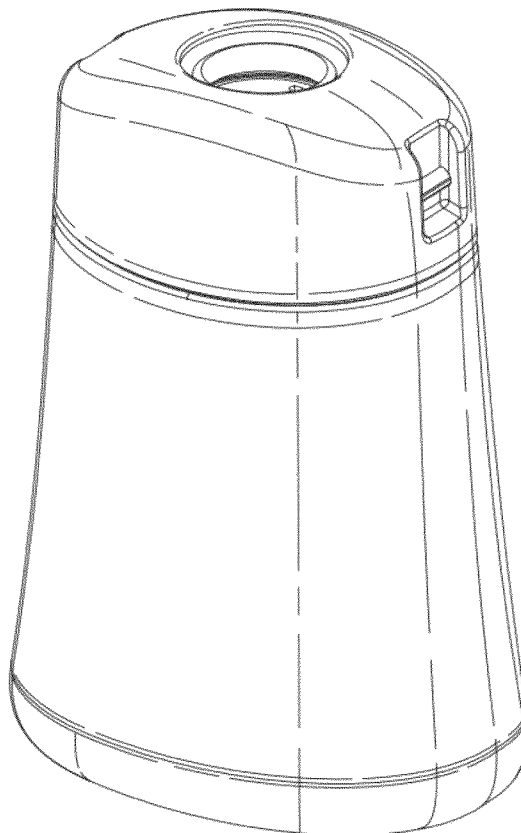
(57) **CLAIM**

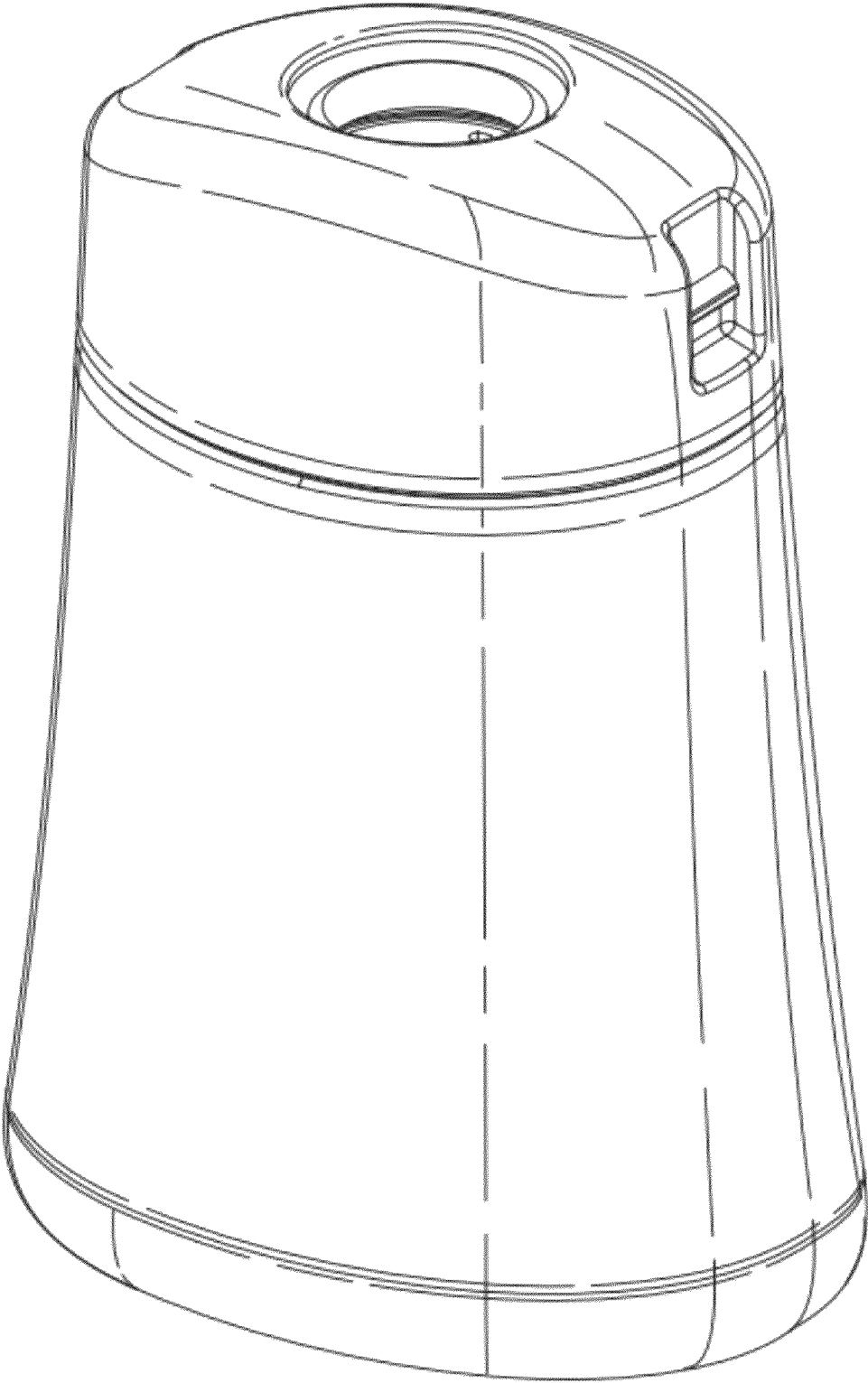
The ornamental design for a refill container for a dispensing device, as shown and described.

**DESCRIPTION**

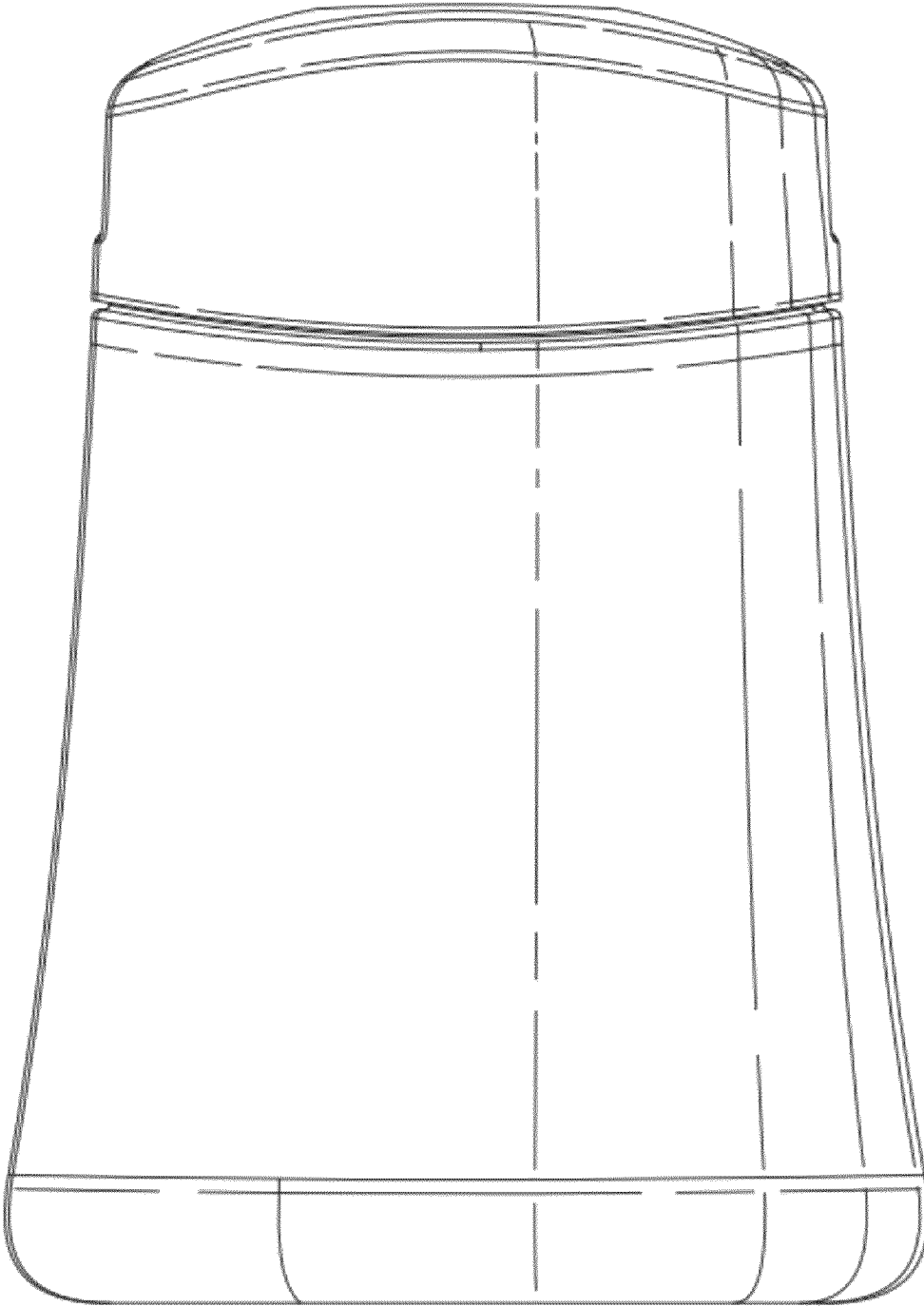
FIG. 1 is a front perspective view of a refill container for a dispensing device of the present invention; FIG. 2 is a front view of the refill container of FIG. 1; FIG. 3 is a back view of the refill container of FIG. 1; FIG. 4 is a side view of the refill container of FIG. 1; FIG. 5 is the other side view of the refill container device of FIG. 1; FIG. 6 is a top view of the refill container of FIG. 1; and FIG. 7 is a bottom view of the refill container of FIG. 1.

**1 Claim, 6 Drawing Sheets**

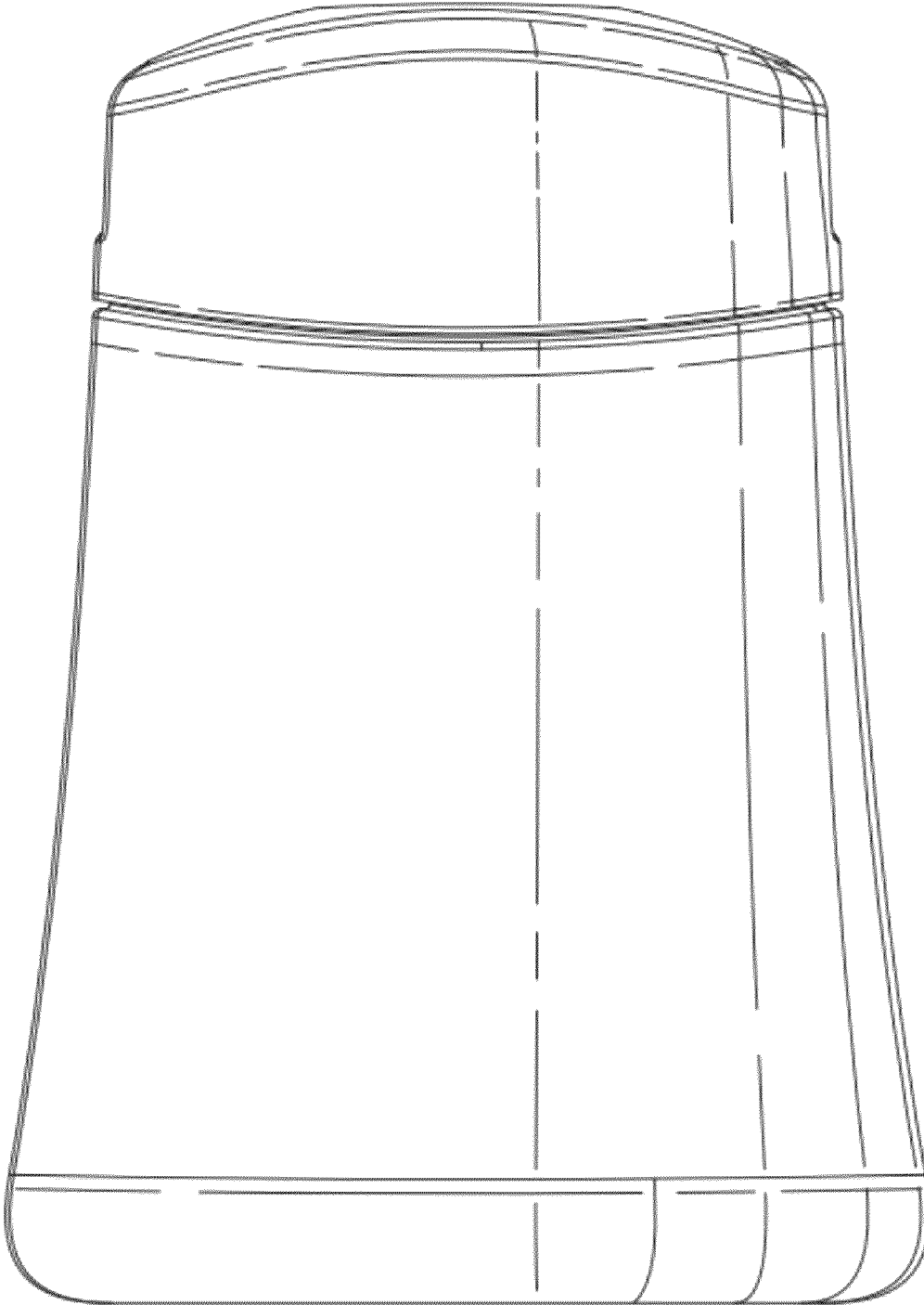




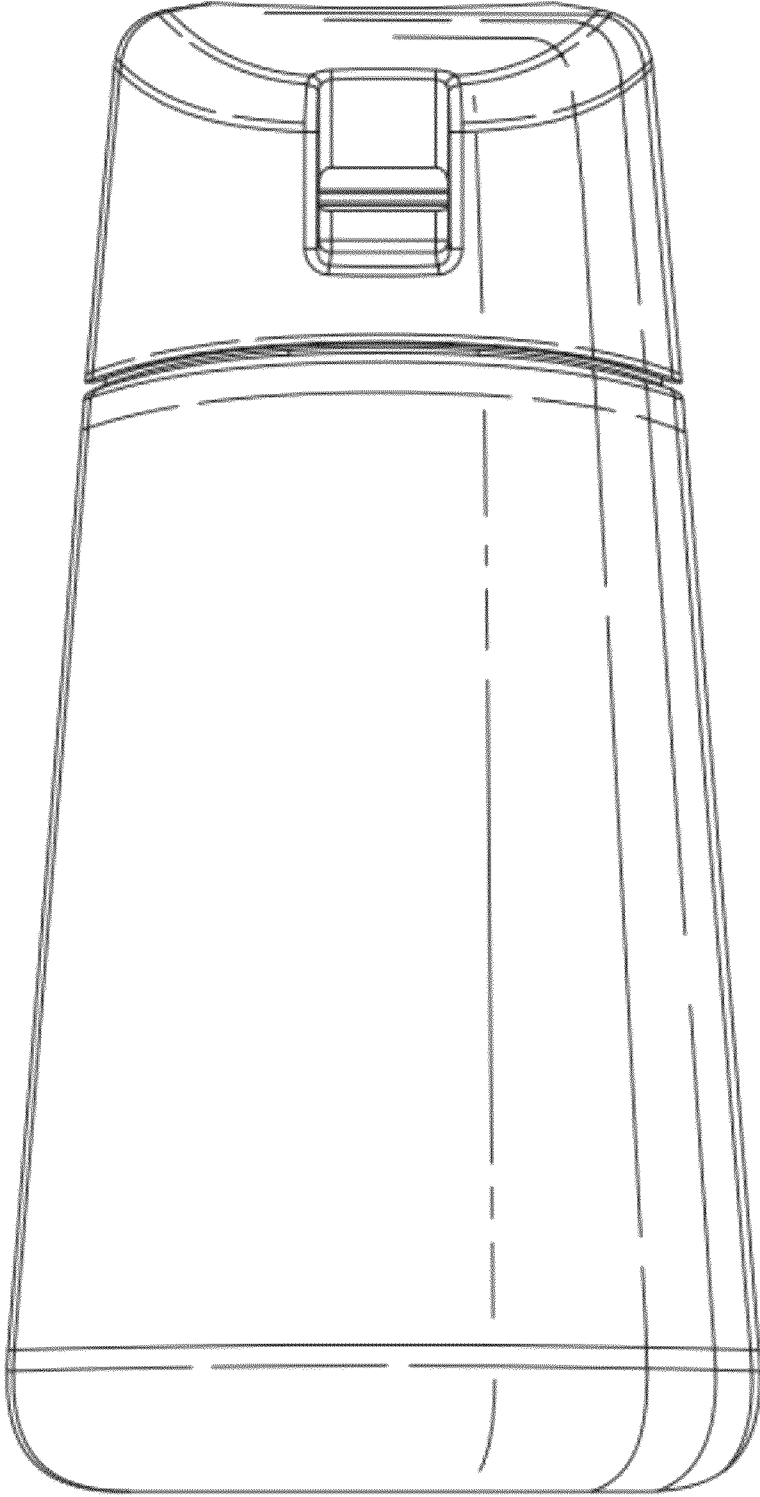
*Fig. 1*



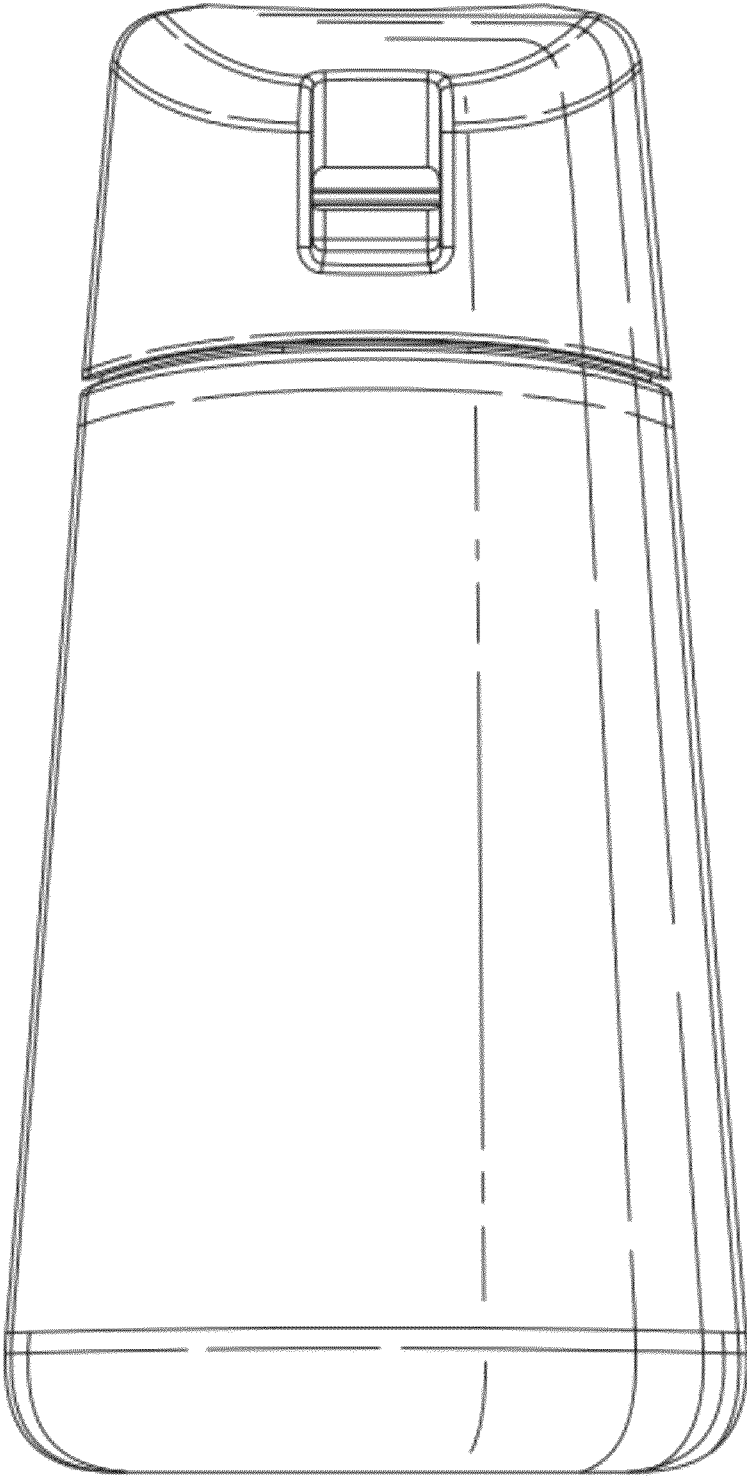
**Fig. 2**



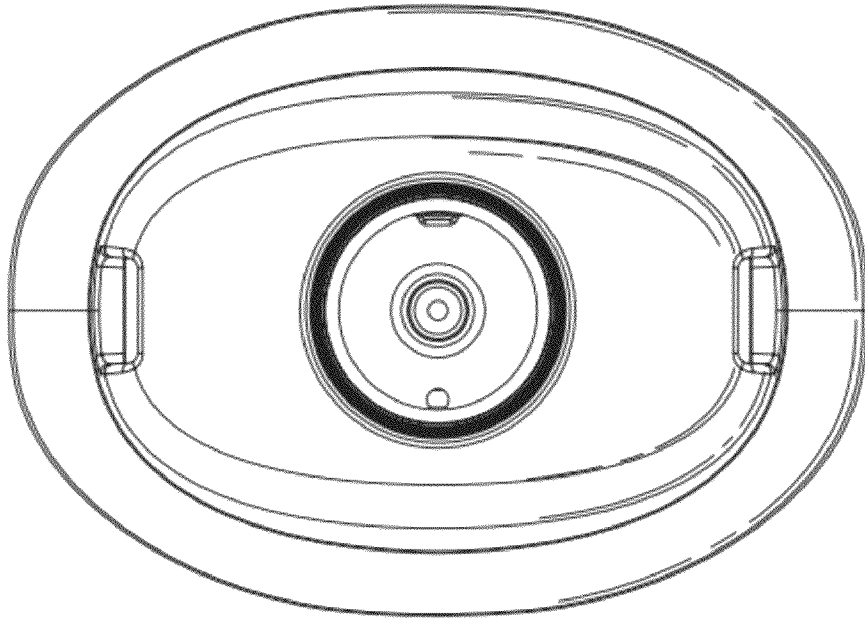
**Fig. 3**



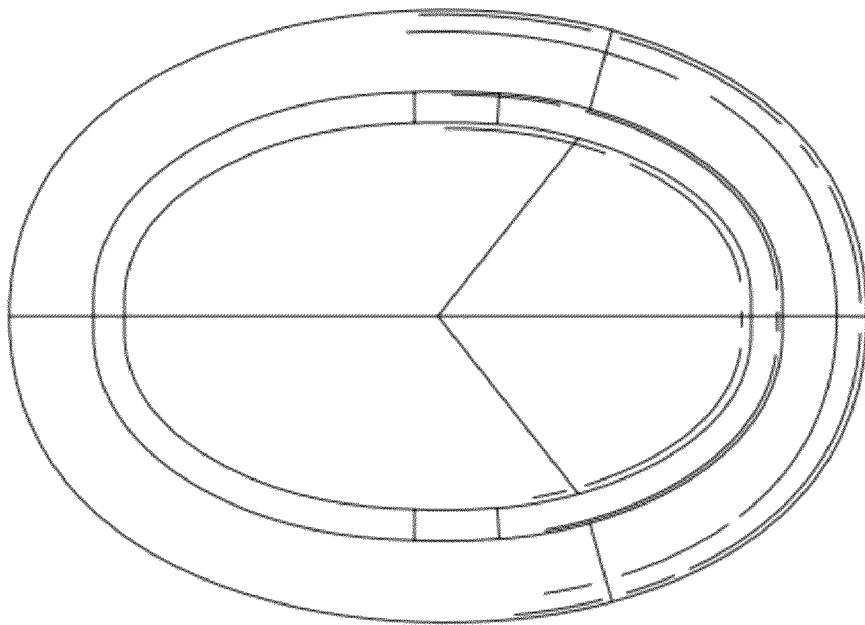
**Fig. 4**



**Fig. 5**



*Fig. 6*



*Fig. 7*