



US00D615730S

(12) **United States Design Patent**
Chionna

(10) **Patent No.:** **US D615,730 S**

(45) **Date of Patent:** **** May 18, 2010**

(54) **TROUSERS**

JP 09021006 A * 1/1997

(76) Inventor: **Carlo Chionna**, Via Lemonia, 54, 40133
Bologna (IT)

OTHER PUBLICATIONS

(**) Term: **14 Years**

Raffaello Network. <http://www.raffaello-network.com/raffties/detail.php?itemid=73275&rangeid=841>. Fall-Winter Jul. 2006. 9.2 by Carlo Chionna Kids Clothing.*

(21) Appl. No.: **29/312,133**

Yoox. <http://www.yoox.com/item.asp?cod10=36129788&TP=11227>. Date Unknown: Viewed Apr. 2009. 9.2 by Carlo Chionna: Collection Yoox Printemps-Ete.*

(22) Filed: **Oct. 1, 2008**

Yoox. <http://www.yoox.com/item.asp?tskay=B490DC11&cod10=42127403&TP=1390>. Date Unknown: Viewed Apr. 2009. 9.2 by Carlo Chionna: Yoox-Kollektion: Fruhling-Sommer.*

(30) **Foreign Application Priority Data**

* cited by examiner

Apr. 4, 2008 (EM) 000911623

(51) **LOC (9) Cl.** **02-02**

Primary Examiner—Ian Simmons

(52) **U.S. Cl.** **D2/742**

Assistant Examiner—R. Johnson

(58) **Field of Classification Search** D2/731,
D2/738, 742; 2/227, 228, 238

(74) *Attorney, Agent, or Firm*—Fay Sharpe LLP

See application file for complete search history.

(57) **CLAIM**

(56) **References Cited**

The ornamental design for trousers, as shown and described.

U.S. PATENT DOCUMENTS

DESCRIPTION

- D269,560 S * 7/1983 Sheppard et al. D2/742
- 4,625,336 A * 12/1986 Derderian 2/79
- D293,617 S * 1/1988 Barrett D2/742
- D459,056 S * 6/2002 Serfontein D2/742
- 6,421,831 B1 * 7/2002 Korff 2/69
- D485,049 S * 1/2004 Newson D2/742
- D527,170 S * 8/2006 Chionna 2/742
- D527,512 S * 9/2006 Chionna D2/742
- D532,958 S * 12/2006 Kent D2/742
- D537,237 S * 2/2007 Chionna D2/742
- D580,629 S * 11/2008 Adams et al. D2/742

FIG. 1 is a front perspective view of trousers showing my new design,

FIG. 2 is a front view,

FIG. 3 is a right side view,

FIG. 4 is a rear view,

FIG. 5 is a left side view,

FIG. 6 is a top view; and,

FIG. 7 is a bottom view.

The broken lines in FIGS. 1–7 are for illustrative purposes only and form no part of the claimed design.

FOREIGN PATENT DOCUMENTS

FR 2873543 A1 * 2/2006

1 Claim, 4 Drawing Sheets

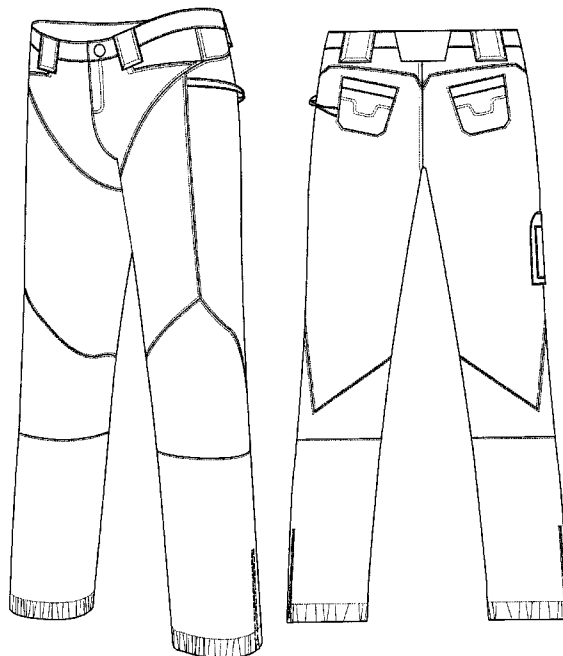

FIG. 1

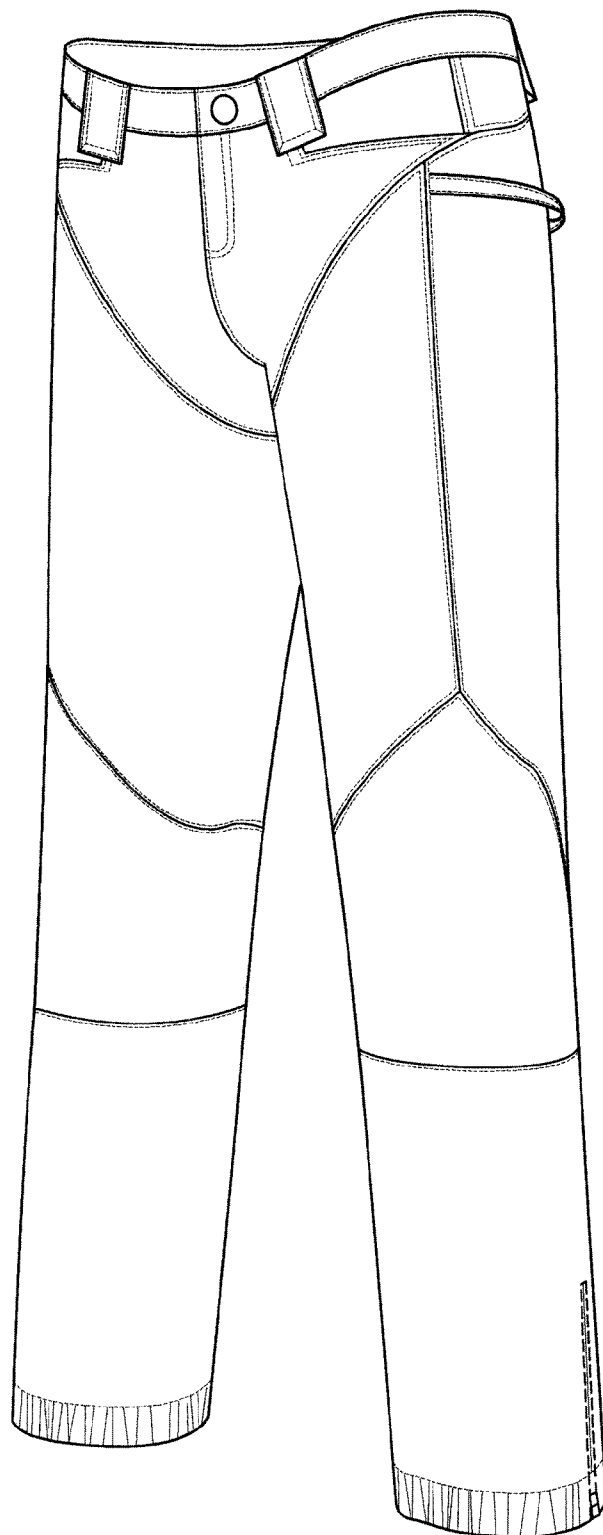

FIG.2

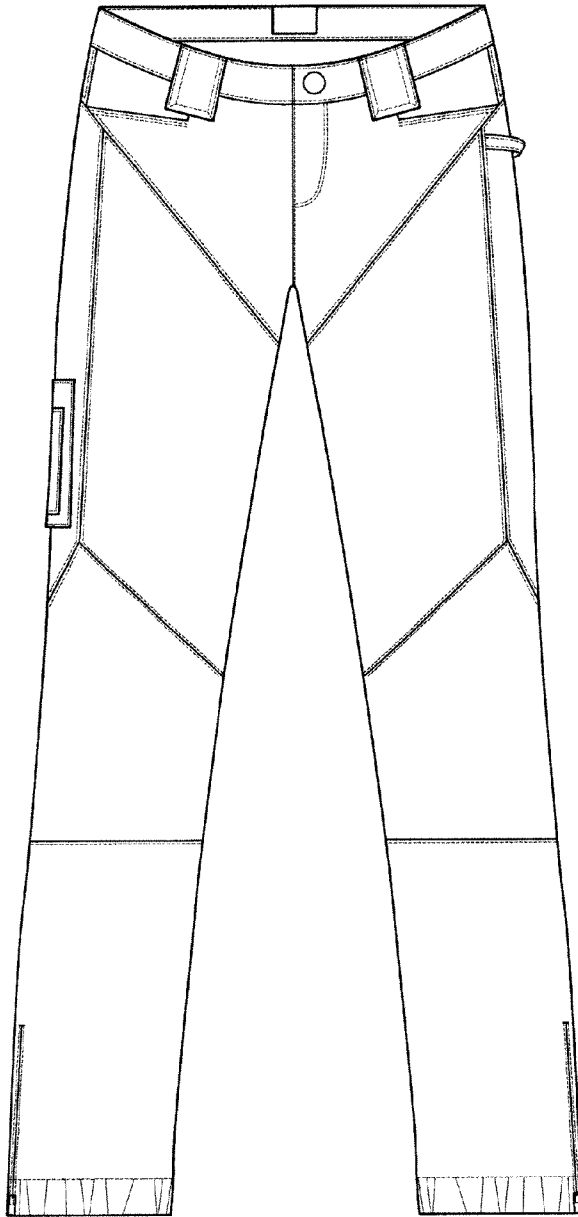

FIG.3

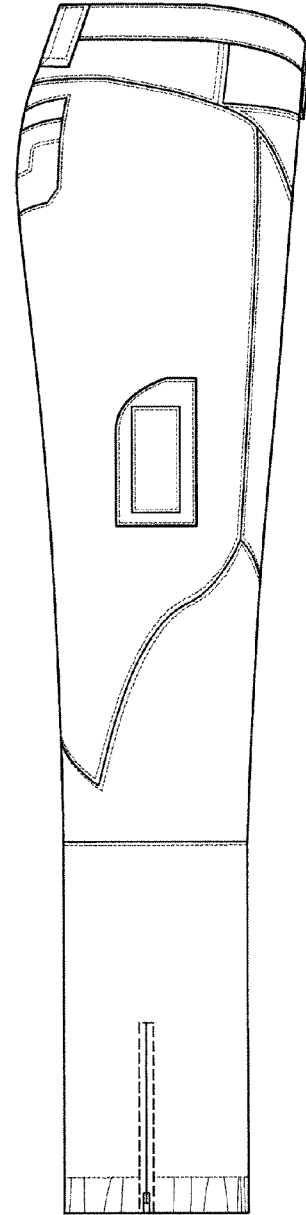

FIG. 4

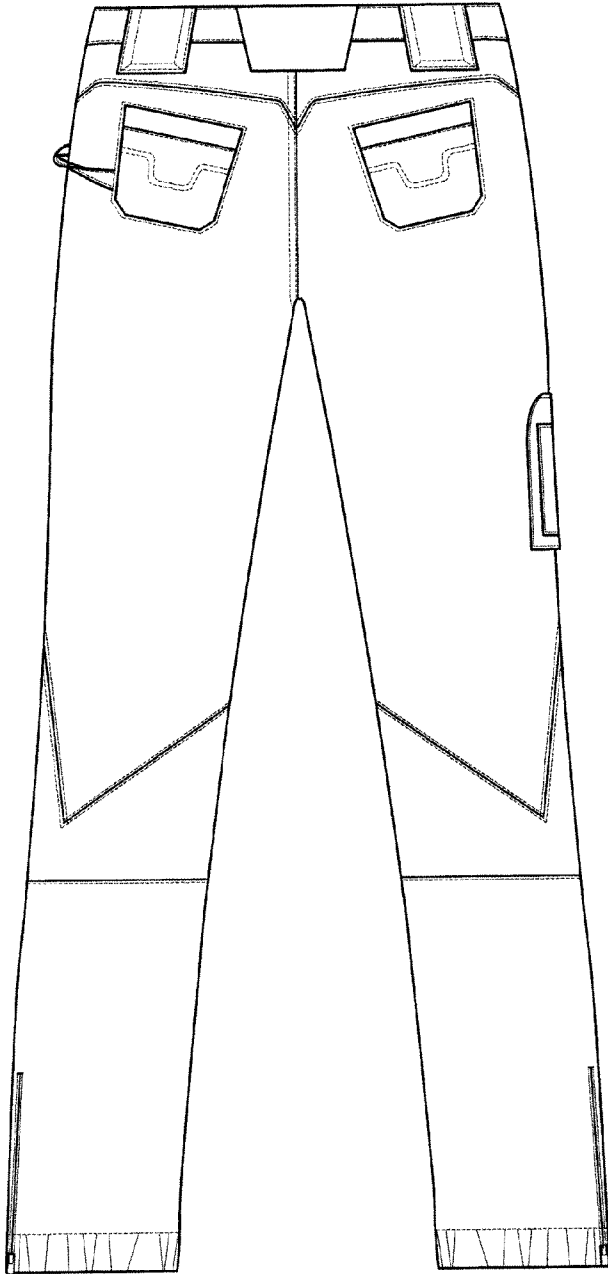

FIG. 5

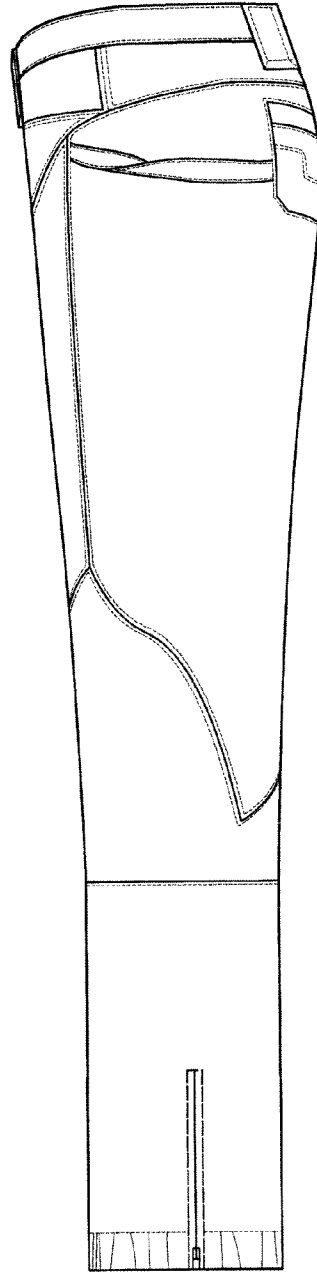

FIG.6

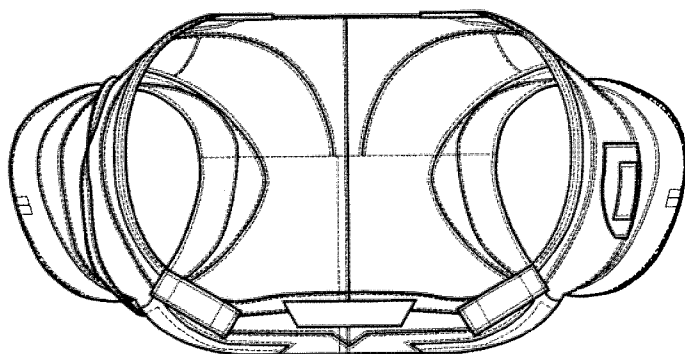

FIG.7

