

[54] SKATEBOARD

4,043,565 8/1977 Mogannam 280/11.12

[76] Inventor: James F. Kish, 96 Fern Ave., Wharton, N.J. 07885

Primary Examiner—Joel Stearman
Assistant Examiner—C. A. Rademaker
Attorney, Agent, or Firm—Lawrence I. Lerner

[**] Term: 14 Years

[57] CLAIM

[21] Appl. No.: 743,514

The ornamental design for a skateboard, substantially as shown and described.

[22] Filed: Nov. 19, 1976

DESCRIPTION

[51] Int. Cl. D21-01

FIG. 1 is a perspective view of a skateboard showing my new design;

[52] U.S. Cl. D34/15 AJ

FIG. 2 is a side elevational view thereof, the opposite side being a mirror image;

[58] Field of Search D34/15 AJ, 15 AT, 40, D34/41; 46/201; 280/87.01, 87.04, 87.04 A, 11.12, 11.22

FIG. 3 is a top plan view thereof;

FIG. 4 is a bottom plan view thereof;

FIG. 5 is a front elevational view thereof;

FIG. 6 is a rear elevational view thereof; and

FIG. 7 is a side elevational view of a second embodiment of the design shown in FIGS. 1 through 6.

[56] References Cited

U.S. PATENT DOCUMENTS

3,945,655	3/1976	Banks	280/87.04 A
3,992,025	11/1976	Amelio	280/87.04 A

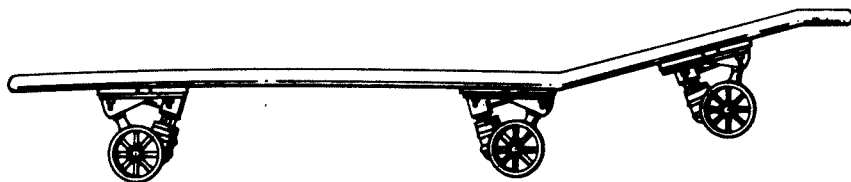
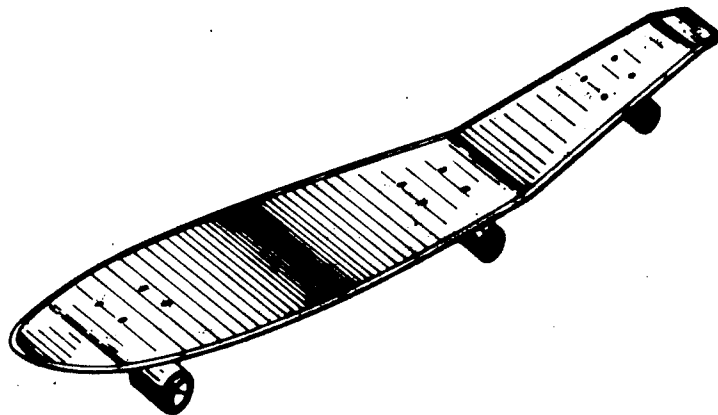

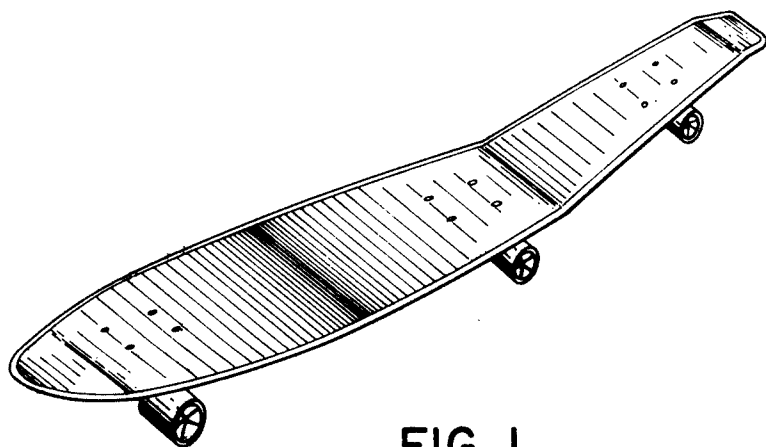

FIG. 1

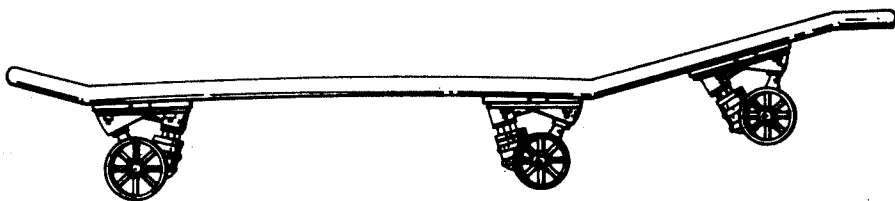

FIG. 2

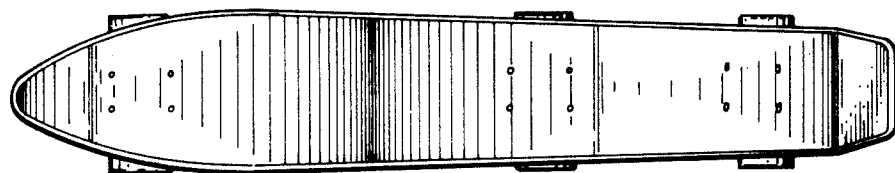

FIG. 3

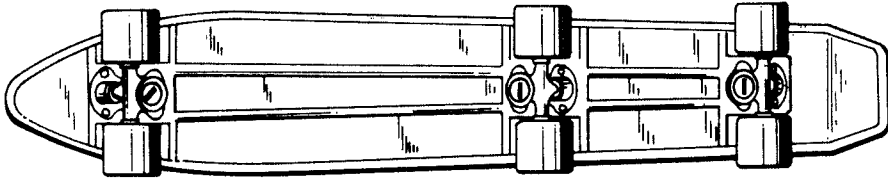

FIG. 4

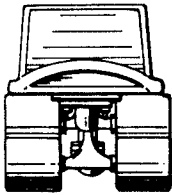

FIG. 5

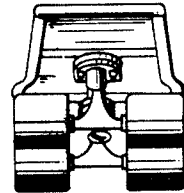

FIG. 6

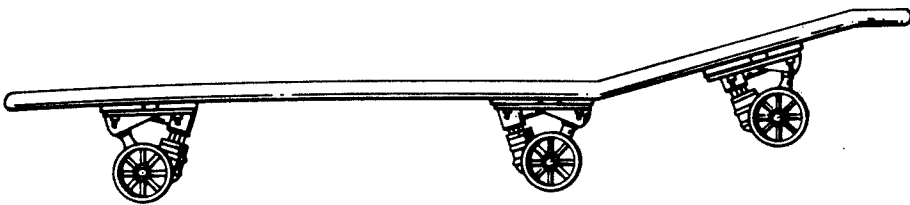

FIG. 7