



- (51) **International Patent Classification:**  
*A61N 1/36* (2006.01)     *A61N 1/372* (2006.01)
- (21) **International Application Number:**  
PCT/US2016/033969
- (22) **International Filing Date:**  
24 May 2016 (24.05.2016)
- (25) **Filing Language:** English
- (26) **Publication Language:** English
- (30) **Priority Data:**  
62/166,569     26 May 2015 (26.05.2015)     US
- (71) **Applicant:** BOSTON SCIENTIFIC NEUROMODULATION CORPORATION [US/US]; 25155 Rye Canyon Loop, Valencia, CA 91355 (US).
- (72) **Inventor:** BOKIL, Hemant; 222 7th St., Unit 203, Santa Monica, CA 90402 (US).
- (74) **Agent:** BLACK, Bruce E.; Lowe Graham Jones PLLC, 701 5th Ave., Suite 4800, Seattle, WA 98104 (US).
- (81) **Designated States** (unless otherwise indicated, for every kind of national protection available): AE, AG, AL, AM, AO, AT, AU, AZ, BA, BB, BG, BH, BN, BR, BW, BY,

BZ, CA, CH, CL, CN, CO, CR, CU, CZ, DE, DK, DM, DO, DZ, EC, EE, EG, ES, FI, GB, GD, GE, GH, GM, GT, HN, HR, HU, ID, IL, IN, IR, IS, JP, KE, KG, KN, KP, KR, KZ, LA, LC, LK, LR, LS, LU, LY, MA, MD, ME, MG, MK, MN, MW, MX, MY, MZ, NA, NG, NI, NO, NZ, OM, PA, PE, PG, PH, PL, PT, QA, RO, RS, RU, RW, SA, SC, SD, SE, SG, SK, SL, SM, ST, SV, SY, TH, TJ, TM, TN, TR, TT, TZ, UA, UG, US, UZ, VC, VN, ZA, ZM, ZW.

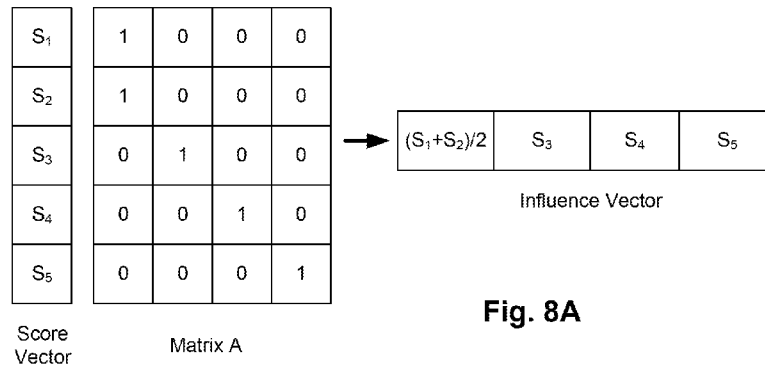
(84) **Designated States** (unless otherwise indicated, for every kind of regional protection available): ARIPO (BW, GH, GM, KE, LR, LS, MW, MZ, NA, RW, SD, SL, ST, SZ, TZ, UG, ZM, ZW), Eurasian (AM, AZ, BY, KG, KZ, RU, TJ, TM), European (AL, AT, BE, BG, CH, CY, CZ, DE, DK, EE, ES, FI, FR, GB, GR, HR, HU, IE, IS, IT, LT, LU, LV, MC, MK, MT, NL, NO, PL, PT, RO, RS, SE, SI, SK, SM, TR), OAPI (BF, BJ, CF, CG, CI, CM, GA, GN, GQ, GW, KM, ML, MR, NE, SN, TD, TG).

**Published:**

- with international search report (Art. 21(3))
- before the expiration of the time limit for amending the claims and to be republished in the event of receipt of amendments (Rule 48.2(h))

WO 2016/191436 A1

(54) **Title:** SYSTEMS AND METHODS FOR ANALYZING ELECTRICAL STIMULATION AND SELECTING OR MANIPULATING VOLUMES OF ACTIVATION



**Fig. 8A**

(57) **Abstract:** A system for identifying potential portions of a body in which electrical stimulation to treat a condition or disorder affects at least one symptom of the condition or disorder, stimulation effect, or side effect performs the following acts: obtaining, for each of multiple stimulation instances, an estimation of a region of the body stimulated during the stimulation instance and a score for each of at least one symptom, stimulation effect, or stimulation side effect; and determining, for each of multiple portions of the body using the scores and the estimates in a permutation test, a likelihood that stimulation of that portion of the body affects at least one symptom, stimulation effect, or stimulation side effect. In other embodiments, the system sets up a relationship between the outcomes of stimulation and influence of a particular part of the body on the outcome, and derives this influence using a pseudoinverse.

SYSTEMS AND METHODS FOR ANALYZING ELECTRICAL STIMULATION  
AND SELECTING OR MANIPULATING VOLUMES OF ACTIVATION

CROSS-REFERENCE TO RELATED APPLICATIONS

This application claims the benefit under 35 U.S.C. § 119(e) of U.S. Provisional  
5 Patent Application Serial No. 62/166,569, filed May 26, 2015, which is incorporated  
herein by reference.

FIELD

The present invention is directed to the area of implantable electrical stimulation  
systems and methods of making and using the systems. The present invention is also  
10 directed to systems for determining regions of the body for stimulation or for selecting or  
manipulating volumes of activation, as well as methods of making and using the systems.

BACKGROUND

Implantable electrical stimulation systems have proven therapeutic in a variety of  
diseases and disorders. For example, spinal cord stimulation systems have been used as a  
15 therapeutic modality for the treatment of chronic pain syndromes. Peripheral nerve  
stimulation has been used to treat chronic pain syndrome and incontinence, with a number  
of other applications under investigation. Functional electrical stimulation systems have  
been applied to restore some functionality to paralyzed extremities in spinal cord injury  
patients. Stimulation of the brain, such as deep brain stimulation, can be used to treat a  
20 variety of diseases or disorders.

Stimulators have been developed to provide therapy for a variety of treatments. A  
stimulator can include a control module (with a pulse generator), one or more leads, and  
an array of stimulator electrodes on each lead. The stimulator electrodes are in contact  
with or near the nerves, muscles, or other tissue to be stimulated. The pulse generator in  
25 the control module generates electrical pulses that are delivered by the electrodes to body  
tissue.

BRIEF SUMMARY

One embodiment is a system for identifying portions of a body in which electrical  
stimulation of that portion of the body to treat a condition or disorder affects at least one  
30 of at least one symptom of the condition or disorder, stimulation effect, or side effect.

The system includes a computer processor configured and arranged to perform the following acts: obtaining, for each of a plurality of stimulation instances, an estimation of a region of the body stimulated during the stimulation instance and a score for each of at least one symptom of the condition or disorder, stimulation effect, or stimulation side effect; determining, for each of a plurality of portions of the body using the scores and the estimates in a permutation test, a likelihood that stimulation of that portion of the body affects at least one symptom of the condition or disorder, stimulation effect, or stimulation side effect; and storing or displaying the determined likelihoods to identify which portions of the body, when electrically stimulated, affect the at least one of the at least one symptom of the condition or disorder, stimulation effect, or stimulation side effect.

Another embodiment is a non-transitory computer-readable medium having processor-executable instructions for identifying portions of a body in which electrical stimulation of that portion of the body to treat a condition or disorder affects at least one of at least one symptom of the condition or disorder, stimulation effect, or side effect, the processor-executable instructions when installed onto a device enable the device to perform actions, including: obtaining, for each of a plurality of stimulation instances, an estimation of a region of the body stimulated during the stimulation instance and a score for each of at least one symptom of the condition or disorder, stimulation effect, or stimulation side effect; determining, for each of a plurality of portions of the body using the scores and the estimates in a permutation test, a likelihood that stimulation of that portion of the body affects at least one symptom of the condition or disorder, stimulation effect, or stimulation side effect; and storing or displaying the determined likelihoods to identify which portions of the body, when electrically stimulated, affect the at least one of the at least one symptom of the condition or disorder, stimulation effect, or stimulation side effect.

Yet another embodiment is a method for identifying portions of a body in which electrical stimulation of that portion of the body to treat a condition or disorder affects at least one of at least one symptom of the condition or disorder, stimulation effect, or side effect. The method includes obtaining, for each of a plurality of stimulation instances, an estimation of a region of the body stimulated during the stimulation instance and a score

for each of at least one symptom of the condition or disorder, stimulation effect, or stimulation side effect; determining, for each of a plurality of portions of the body using the scores and the estimates in a permutation test, a likelihood that stimulation of that portion of the body affects at least one symptom of the condition or disorder, stimulation effect, or stimulation side effect; and storing or displaying the determined likelihoods to identify which portions of the body, when electrically stimulated, affect the at least one of the at least one symptom of the condition or disorder, stimulation effect, or stimulation side effect.

In at least some embodiments of the system, non-transitory computer-readable medium, or method described above, further including obtaining the plurality of stimulation instances and, for each stimulation instance, a set of stimulation parameters. In at least some embodiments of the system, non-transitory computer-readable medium, or method described above, obtaining an estimation of a region of the body stimulated during the stimulation instance includes estimating the region of the body stimulation during the stimulation instance based on stimulation parameters used during the stimulation instance.

In at least some embodiments of the system, non-transitory computer-readable medium, or method described above, determining a likelihood includes forming a matrix for a selected portion of the body and for a selected symptom of the condition or disorder, stimulation effect, or stimulation side effect, the matrix including a plurality of rows and columns, where one of the columns or rows corresponds to each stimulation instance, where, for each of a plurality of the stimulation instances, a first entry in a column or row indicates whether the selected portion of the body is stimulated in that stimulation instance and a second entry in the column or row corresponds to the score for the selected symptom of the condition or disorder, stimulation effect, or side effect for that stimulation instance. In at least some embodiments of the system, non-transitory computer-readable medium, or method described above, determining a likelihood further includes determining a likelihood that a null hypothesis is invalid, where the null hypothesis is that the selected portion of the body does not influence the scores for the selected symptom of the condition or disorder, stimulation effect, or side effect. In at least some embodiments of the system, non-transitory computer-readable medium, or method described above,

determining a likelihood further includes determining a difference between scores where the preselected portion of the body is stimulated and scores where the preselected portion of the body is not stimulated. In at least some embodiments of the system, non-transitory computer-readable medium, or method described above, determining a likelihood further includes randomizing the second entries with respect to the first entries to form a plurality of additional matrices. In at least some embodiments of the system, non-transitory computer-readable medium, or method described above, determining a likelihood further includes generating a distribution based on the matrix and the plurality of additional matrices.

10 In at least some embodiments of the system, non-transitory computer-readable medium, or method described above, obtaining the plurality of stimulation instances includes obtaining the plurality of stimulation instances from a plurality of patients.

A further embodiment is a system for identifying portions of a body in which electrical stimulation of that portion of the body to treat a condition or disorder affects at least one of at least one symptom of the condition or disorder, stimulation effect, or stimulation side effect. The system includes a computer processor configured and arranged to perform the following acts: obtaining N stimulation instances, where N is an integer greater than one, and, for each stimulation instance, an outcome score for each of at least one symptom of the condition or disorder, stimulation effect, or stimulation side effect; selecting M portions of the body, where M is an integer greater than one; estimating, for each of the N stimulation instances and for each of the M portions of the body, whether that portion of the body was stimulated during that stimulation instance; generating a matrix, where the matrix is either a) a N x M matrix with entries  $a_{ij}$  or b) a M x N matrix with entries  $a_{ji}$ , where i is an integer ranging from 1 to N and corresponds to the  $i^{\text{th}}$  stimulation instance and j is an integer ranging from 1 to M and corresponds to a  $j^{\text{th}}$  portion of the body, where  $a_{ij}$  or  $a_{ji}$ , respectively, is 0 if the  $j^{\text{th}}$  portion of the body is not stimulated during the  $i^{\text{th}}$  stimulation instance and is a non-zero value if the  $j^{\text{th}}$  portion of the body is stimulated during the  $i^{\text{th}}$  stimulation instance; determining a pseudoinverse of the matrix to estimate an influence of each of the M portions of the body on the outcome scores for the N stimulation instances; and storing or displaying the estimated influences to identify which portions of the body, when electrically stimulated, affect the at least one

of the at least one symptom of the condition or disorder, stimulation effect, or stimulation side effect.

Another embodiment is a non-transitory computer-readable medium having processor-executable instructions for identifying portions of a body in which electrical stimulation of that portion of the body to treat a condition or disorder affects at least one of at least one symptom of the condition or disorder, stimulation effect, or stimulation side effect, the processor-executable instructions when installed onto a device enable the device to perform actions, including: obtaining  $N$  stimulation instances, where  $N$  is an integer greater than one, and, for each stimulation instance, an outcome score for each of at least one symptom of the condition or disorder, stimulation effect, or stimulation side effect; selecting  $M$  portions of the body, where  $M$  is an integer greater than one; estimating, for each of the  $N$  stimulation instances and for each of the  $M$  portions of the body, whether that portion of the body was stimulated during that stimulation instance; generating a matrix, where the matrix is either a) a  $N \times M$  matrix with entries  $a_{ij}$  or b) a  $M \times N$  matrix with entries  $a_{ji}$ , where  $i$  is an integer ranging from 1 to  $N$  and corresponds to the  $i^{\text{th}}$  stimulation instance and  $j$  is an integer ranging from 1 to  $M$  and corresponds to a  $j^{\text{th}}$  portion of the body, where  $a_{ij}$  or  $a_{ji}$ , respectively, is 0 if the  $j^{\text{th}}$  portion of the body is not stimulated during the  $i^{\text{th}}$  stimulation instance and is a non-zero value if the  $j^{\text{th}}$  portion of the body is stimulated during the  $i^{\text{th}}$  stimulation instance; determining a pseudoinverse of the matrix to estimate an influence of each of the  $M$  portions of the body on the outcome scores for the  $N$  stimulation instances; and storing or displaying the estimated influences to identify which portions of the body, when electrically stimulated, affect the at least one of the at least one symptom of the condition or disorder, stimulation effect, or stimulation side effect.

Yet another embodiment is a method for identifying portions of a body in which electrical stimulation of that portion of the body to treat a condition or disorder affects at least one of at least one symptom of the condition or disorder, stimulation effect, or stimulation side effect. The method includes obtaining  $N$  stimulation instances, where  $N$  is an integer greater than one, and, for each stimulation instance, an outcome score for each of at least one symptom of the condition or disorder, stimulation effect, or stimulation side effect; selecting  $M$  portions of the body, where  $M$  is an integer greater

than one; estimating, for each of the N stimulation instances and for each of the M portions of the body, whether that portion of the body was stimulated during that stimulation instance; generating a matrix, where the matrix is either a) a N x M matrix with entries  $a_{ij}$  or b) a M x N matrix with entries  $a_{ji}$ , where i is an integer ranging from 1 to N and corresponds to the  $i^{\text{th}}$  stimulation instance and j is an integer ranging from 1 to M and corresponds to a  $j^{\text{th}}$  portion of the body, where  $a_{ij}$  or  $a_{ji}$ , respectively, is 0 if the  $j^{\text{th}}$  portion of the body is not stimulated during the  $i^{\text{th}}$  stimulation instance and is a non-zero value if the  $j^{\text{th}}$  portion of the body is stimulated during the  $i^{\text{th}}$  stimulation instance; determining a pseudoinverse of the matrix to estimate an influence of each of the M portions of the body on the outcome scores for the N stimulation instances; and storing or displaying the estimated influences to identify which portions of the body, when electrically stimulated, affect the at least one of the at least one symptom of the condition or disorder, stimulation effect, or stimulation side effect.

In at least some embodiments of the system, non-transitory computer-readable medium, or method described above, estimating, for each of the N stimulation instances and for each of the M portions of the body, whether that portion of the body was stimulated during that stimulation instance includes estimating, for each of the N stimulation instances and for each of the M portions of the body, whether that portion of the body was stimulated during that stimulation instance based on stimulation parameters used during the stimulation instance. In at least some embodiments of the system, non-transitory computer-readable medium, or method described above, obtaining N stimulation instances includes obtaining the N stimulation instances from a plurality of patients. In at least some embodiments of the system, non-transitory computer-readable medium, or method described above, further including generating a score vector including the outcome scores for the N stimulation instances. In at least some embodiments of the system, non-transitory computer-readable medium, or method described above, determining a pseudoinverse of the matrix includes determining an influence vector using the pseudoinverse and score vector, where each entry in the influence vector corresponds to a different portion of the body. In at least some embodiments of the system, non-transitory computer-readable medium, or method described above, the entries of the influence vector indicate a relative influence of the

corresponding portions of the body relative to the at least one symptom of the condition or disorder, stimulation effect, or stimulation side effect.

A further embodiment is a system for selecting or manipulating volumes of activation for electrical stimulation. The system includes a computer processor  
5 configured and arranged to perform the following acts: presenting a graphical user interface that includes at least one user-activatable button selected from a union button, an intersection button, or a subtraction button; displaying at least two volumes of activation; and in response to user activation of the at least one user-activatable button, displaying a union, an intersection, or a subtraction of at least two of the at least two volumes of  
10 activation.

Another embodiment is a non-transitory computer-readable medium having processor-executable instructions for selecting or manipulating volumes of activation for electrical stimulation, the processor-executable instructions when installed onto a device enable the device to perform actions, including: presenting a graphical user interface that  
15 includes at least one user-activatable button selected from a union button, an intersection button, or a subtraction button; displaying at least two volumes of activation; and in response to user activation of the at least one user-activatable button, displaying a union, an intersection, or a subtraction of at least two of the at least two volumes of activation.

Yet another embodiment is a method for selecting or manipulating volumes of  
20 activation for electrical stimulation. The method includes presenting a graphical user interface that includes at least one user-activatable button selected from a union button, an intersection button, or a subtraction button; displaying at least two volumes of activation; and in response to user activation of the at least one user-activatable button, displaying a union, an intersection, or a subtraction of at least two of the at least two volumes of  
25 activation.

In at least some embodiments of the system, non-transitory computer-readable medium, or method described above, the graphical user interface includes a union button, an intersection button, and a subtraction button. In at least some embodiments of the system, non-transitory computer-readable medium, or method described above, the  
30 volumes of activation further contain metadata associated with the volumes of activation.

In at least some embodiments of the system, non-transitory computer-readable medium, or method described above, the graphical user interface further includes a search button. In at least some embodiments of the system, non-transitory computer-readable medium, or method described above, the acts further include in response to user activation of the search button, allowing the user to indicate one or more search terms; and searching  
5 metadata of a set of volumes of activation using the one or more search terms to identify one or more volumes of activation with metadata corresponding to the one or more search terms.

### BRIEF DESCRIPTION OF THE DRAWINGS

10 Non-limiting and non-exhaustive embodiments of the present invention are described with reference to the following drawings. In the drawings, like reference numerals refer to like parts throughout the various figures unless otherwise specified.

For a better understanding of the present invention, reference will be made to the following Detailed Description, which is to be read in association with the accompanying  
15 drawings, wherein:

FIG. 1 is a schematic view of one embodiment of an electrical stimulation system, according to the invention;

FIG. 2 is a schematic side view of one embodiment of an electrical stimulation lead, according to the invention;

20 FIG. 3 is a schematic block diagram of one embodiment of a system for determining stimulation parameters, according to the invention;

FIG. 4 is a schematic flowchart of one embodiment of a method of identifying portions of a body for electrical stimulation, according to the invention;

25 FIG. 5A is a schematic illustration of one embodiment of a matrix for use in the method of FIG. 4, according to the invention;

FIG. 5B is a schematic illustration of one embodiment of a randomized matrix for use in the method of FIG. 4, according to the invention;

FIG. 5C is a schematic illustration of one embodiment of a distribution of values obtained using the method of FIG. 4, according to the invention;

FIG. 6 is a schematic flowchart of one embodiment of another method of identifying portions of a body for electrical stimulation, according to the invention;

5 FIG. 7A is a schematic illustration of one embodiment of a matrix for use in the method of FIG. 6, according to the invention;

FIG. 7B is a schematic illustration of one embodiment of a score vector for use in the method of FIG. 6, according to the invention;

10 FIG. 8A is a schematic illustration of one embodiment of a determination of an influence vector using the method of FIG. 6, according to the invention;

FIG. 8B is a schematic illustration of one embodiment of another determination of an influence vector using the method of FIG. 6, according to the invention;

FIG. 9A is a schematic illustration of one embodiment of a graphical user interface for selecting or manipulating volumes of activation, according to the invention;

15 FIG. 9B is a schematic illustration of the graphical user interface of FIG. 9A in which the union of two volumes of activation is presented, according to the invention;

FIG. 9C is a schematic illustration of the graphical user interface of FIG. 9A in which the intersection of two volumes of activation is presented, according to the invention; and

20 FIG. 9D is a schematic illustration of the graphical user interface of FIG. 9A in which the subtraction of one volume of activation from another volume of activation is presented, according to the invention.

#### DETAILED DESCRIPTION

25 The present invention is directed to the area of implantable electrical stimulation systems and methods of making and using the systems. The present invention is also directed to systems for determining regions of the body for stimulation or for selecting or manipulating volumes of activation, as well as methods of making and using the systems.

Suitable implantable electrical stimulation systems include, but are not limited to, a least one lead with one or more electrodes disposed on a distal end of the lead and one or more terminals disposed on one or more proximal ends of the lead. Leads include, for example, percutaneous leads and paddle leads. Examples of electrical stimulation systems with leads are found in, for example, U.S. Patents Nos. 6,181,969; 6,516,227; 6,609,029; 6,609,032; 6,741,892; 7,244,150; 7,450,997; 7,672,734; 7,761,165; 7,783,359; 7,792,590; 7,809,446; 7,949,395; 7,974,706; 8,175,710; 8,224,450; 8,271,094; 8,295,944; 8,364,278; 8,391,985; and 8,688,235; and U.S. Patent Applications Publication Nos. 2007/0150036; 2009/0187222; 2009/0276021; 2010/0076535; 2010/0268298; 2011/0005069; 2011/0004267; 2011/0078900; 2011/0130817; 2011/0130818; 2011/0238129; 2011/0313500; 2012/0016378; 2012/0046710; 2012/0071949; 2012/0165911; 2012/0197375; 2012/0203316; 2012/0203320; 2012/0203321; 2012/0316615; 2013/0105071; and 2013/0197602, all of which are incorporated by reference. In the discussion below, a percutaneous lead will be exemplified, but it will be understood that the methods and systems described herein are also applicable to paddle leads.

A percutaneous lead for electrical stimulation (for example, deep brain or spinal cord stimulation) includes stimulation electrodes that can be ring electrodes or segmented electrodes that extend only partially around the circumference of the lead or any combination thereof. The segmented electrodes can be provided in sets of electrodes, with each set having electrodes circumferentially distributed about the lead at a particular longitudinal position. For illustrative purposes, the leads are described herein relative to use for deep brain stimulation, but it will be understood that any of the leads can be used for applications other than deep brain stimulation, including spinal cord stimulation, peripheral nerve stimulation, or stimulation of other nerves and tissues.

Turning to Figure 1, one embodiment of an electrical stimulation system includes one or more stimulation leads 12 and an implantable pulse generator (IPG) 14. The system 10 can also include one or more of an external remote control (RC) 16, a clinician's programmer (CP) 18, an external trial stimulator (ETS) 20, or an external charger 22.

The IPG 14 is physically connected, optionally via one or more lead extensions 24, to the stimulation lead(s) 12. Each lead carries multiple electrodes 26 arranged in an

array. The IPG 14 includes pulse generation circuitry that delivers electrical stimulation energy in the form of, for example, a pulsed electrical waveform (i.e., a temporal series of electrical pulses) to the electrode array 26 in accordance with a set of stimulation parameters. The implantable pulse generator can be implanted into a patient's body, for example, below the patient's clavicle area or within the patient's buttocks or abdominal cavity. The implantable pulse generator can have eight stimulation channels which may be independently programmable to control the magnitude of the current stimulus from each channel. In some embodiments, the implantable pulse generator can have more or fewer than eight stimulation channels (e.g., 4-, 6-, 16-, 32-, or more stimulation channels). The implantable pulse generator can have one, two, three, four, or more connector ports, for receiving the terminals of the leads.

The ETS 20 may also be physically connected, optionally via the percutaneous lead extensions 28 and external cable 30, to the stimulation leads 12. The ETS 20, which has similar pulse generation circuitry as the IPG 14, also delivers electrical stimulation energy in the form of, for example, a pulsed electrical waveform to the electrode array 26 in accordance with a set of stimulation parameters. One difference between the ETS 20 and the IPG 14 is that the ETS 20 is often a non-implantable device that is used on a trial basis after the neurostimulation leads 12 have been implanted and prior to implantation of the IPG 14, to test the responsiveness of the stimulation that is to be provided. Any functions described herein with respect to the IPG 14 can likewise be performed with respect to the ETS 20.

The RC 16 may be used to telemetrically communicate with or control the IPG 14 or ETS 20 via a uni- or bi-directional wireless communications link 32. Once the IPG 14 and neurostimulation leads 12 are implanted, the RC 16 may be used to telemetrically communicate with or control the IPG 14 via a uni- or bi-directional communications link 34. Such communication or control allows the IPG 14 to be turned on or off and to be programmed with different stimulation parameter sets. The IPG 14 may also be operated to modify the programmed stimulation parameters to actively control the characteristics of the electrical stimulation energy output by the IPG 14. The CP 18 allows a user, such as a clinician, the ability to program stimulation parameters for the IPG 14 and ETS 20 in the operating room and in follow-up sessions.

The CP 18 may perform this function by indirectly communicating with the IPG 14 or ETS 20, through the RC 16, via a wireless communications link 36. Alternatively, the CP 18 may directly communicate with the IPG 14 or ETS 20 via a wireless communications link (not shown). The stimulation parameters provided by the CP 18 are also used to program the RC 16, so that the stimulation parameters can be subsequently modified by operation of the RC 16 in a stand-alone mode (i.e., without the assistance of the CP 18).

For purposes of brevity, the details of the RC 16, CP 18, ETS 20, and external charger 22 will not be further described herein. Details of exemplary embodiments of these devices are disclosed in U.S. Pat. No. 6,895,280, which is expressly incorporated herein by reference. Other examples of electrical stimulation systems can be found at U.S. Patents Nos. 6,181,969; 6,516,227; 6,609,029; 6,609,032; 6,741,892; 7,949,395; 7,244,150; 7,672,734; and 7,761,165; 7,974,706; 8,175,710; 8,224,450; and 8,364,278; and U.S. Patent Application Publication No. 2007/0150036, as well as the other references cited above, all of which are incorporated by reference.

Figure 2 illustrates one embodiment of a lead 110 with electrodes 125 disposed at least partially about a circumference of the lead 110 along a distal end portion of the lead and terminals 135 disposed along a proximal end portion of the lead. The lead 110 can be implanted near or within the desired portion of the body to be stimulated such as, for example, the brain, spinal cord, or other body organs or tissues. In one example of operation for deep brain stimulation, access to the desired position in the brain can be accomplished by drilling a hole in the patient's skull or cranium with a cranial drill (commonly referred to as a burr), and coagulating and incising the dura mater, or brain covering. The lead 110 can be inserted into the cranium and brain tissue with the assistance of a stylet (not shown). The lead 110 can be guided to the target location within the brain using, for example, a stereotactic frame and a microdrive motor system. In some embodiments, the microdrive motor system can be fully or partially automatic. The microdrive motor system may be configured to perform one or more the following actions (alone or in combination): insert the lead 110, advance the lead 110, retract the lead 110, or rotate the lead 110.

In some embodiments, measurement devices coupled to the muscles or other tissues stimulated by the target neurons, or a unit responsive to the patient or clinician, can be coupled to the implantable pulse generator or microdrive motor system. The measurement device, user, or clinician can indicate a response by the target muscles or other tissues to the stimulation or recording electrode(s) to further identify the target neurons and facilitate positioning of the stimulation electrode(s). For example, if the target neurons are directed to a muscle experiencing tremors, a measurement device can be used to observe the muscle and indicate changes in tremor frequency or amplitude in response to stimulation of neurons. Alternatively, the patient or clinician can observe the muscle and provide feedback.

The lead 110 for deep brain stimulation can include stimulation electrodes, recording electrodes, or both. In at least some embodiments, the lead 110 is rotatable so that the stimulation electrodes can be aligned with the target neurons after the neurons have been located using the recording electrodes.

Stimulation electrodes may be disposed on the circumference of the lead 110 to stimulate the target neurons. Stimulation electrodes may be ring-shaped so that current projects from each electrode equally in every direction from the position of the electrode along a length of the lead 110. In the embodiment of Figure 2, two of the electrodes are ring electrodes 120. Ring electrodes typically do not enable stimulus current to be directed from only a limited angular range around of the lead. Segmented electrodes 130, however, can be used to direct stimulus current to a selected angular range around the lead. When segmented electrodes are used in conjunction with an implantable pulse generator that delivers constant current stimulus, current steering can be achieved to more precisely deliver the stimulus to a position around an axis of the lead (*i.e.*, radial positioning around the axis of the lead). To achieve current steering, segmented electrodes can be utilized in addition to, or as an alternative to, ring electrodes.

The lead 100 includes a lead body 110, terminals 135, and one or more ring electrodes 120 and one or more sets of segmented electrodes 130 (or any other combination of electrodes). The lead body 110 can be formed of a biocompatible, non-conducting material such as, for example, a polymeric material. Suitable polymeric materials include, but are not limited to, silicone, polyurethane, polyurea, polyurethane-

urea, polyethylene, or the like. Once implanted in the body, the lead 100 may be in contact with body tissue for extended periods of time. In at least some embodiments, the lead 100 has a cross-sectional diameter of no more than 1.5 mm and may be in the range of 0.5 to 1.5 mm. In at least some embodiments, the lead 100 has a length of at least 10  
5 cm and the length of the lead 100 may be in the range of 10 to 70 cm.

The electrodes 125 can be made using a metal, alloy, conductive oxide, or any other suitable conductive biocompatible material. Examples of suitable materials include, but are not limited to, platinum, platinum iridium alloy, iridium, titanium, tungsten, palladium, palladium rhodium, or the like. Preferably, the electrodes are made of a  
10 material that is biocompatible and does not substantially corrode under expected operating conditions in the operating environment for the expected duration of use.

Each of the electrodes can either be used or unused (OFF). When the electrode is used, the electrode can be used as an anode or cathode and carry anodic or cathodic current. In some instances, an electrode might be an anode for a period of time and a  
15 cathode for a period of time.

Deep brain stimulation leads may include one or more sets of segmented electrodes. Segmented electrodes may provide for superior current steering than ring electrodes because target structures in deep brain stimulation are not typically symmetric about the axis of the distal electrode array. Instead, a target may be located on one side of  
20 a plane running through the axis of the lead. Through the use of a radially segmented electrode array ("RSEA"), current steering can be performed not only along a length of the lead but also around a circumference of the lead. This provides precise three-dimensional targeting and delivery of the current stimulus to neural target tissue, while potentially avoiding stimulation of other tissue. Examples of leads with segmented  
25 electrodes include U.S. Patent Application Publications Nos. 2010/0268298; 2011/0005069; 2011/0130803; 2011/0130816; 2011/0130817; 2011/0130818; 2011/0078900; 2011/0238129; 2012/0016378; 2012/0046710; 2012/0071949; 2012/0165911; 2012/197375; 2012/0203316; 2012/0203320; 2012/0203321, all of which are incorporated herein by reference.

An electrical stimulation lead can be implanted in the body of a patient (for example, in the brain or spinal cord of the patient) and used to stimulate surrounding tissue. It is useful to estimate the effective region of stimulation (often called a volume of activation (VOA) or stimulation field model (SFM)) given the position of the lead and its electrodes in the patient's body and the stimulation parameters used to generate the stimulation. Any suitable method for determining the VOA and for graphically displaying the VOA relative to patient anatomy can be used including those described in, for example, U.S. Patents Nos. 8,326,433; 8,675,945; 8,831,731; 8,849,632; and 8,958,615; U.S. Patent Application Publications Nos. 2009/0287272; 2009/0287273; 2012/0314924; 2013/0116744; 2014/0122379; and 2015/0066111; and U.S. Provisional Patent Application Serial No. 62/030,655, all of which are incorporated herein by reference. Several of these references also disclose methods and systems for registering an atlas of body structures to imaged patient physiology.

A VOA can be determined based on a set of stimulation parameters input into the system. The VOA can then be modified by the user by modifying the stimulation parameters and determining the new VOA from the modified stimulation parameters. This allows the user to tailor the stimulation volume.

Figure 3 illustrates one embodiment of a system for determining electrical stimulation parameters. The system can include a computing device 300 or any other similar device that includes a processor 302 and a memory 304, a display 306, an input device 308, and, optionally, the electrical stimulation system 312. The system 300 may also optionally include one or more imaging systems 310.

The computing device 300 can be a computer, tablet, mobile device, or any other suitable device for processing information. The computing device 300 can be local to the user or can include components that are non-local to the computer including one or both of the processor 302 or memory 304 (or portions thereof). For example, in some embodiments, the user may operate a terminal that is connected to a non-local computing device. In other embodiments, the memory can be non-local to the user.

The computing device 300 can utilize any suitable processor 302 including one or more hardware processors that may be local to the user or non-local to the user or other

components of the computing device. The processor 302 is configured to execute instructions provided to the processor.

Any suitable memory 304 can be used for the computing device 302. The memory 304 illustrates a type of computer-readable media, namely computer-readable storage media. Computer-readable storage media may include, but is not limited to, nonvolatile, non-transitory, removable, and non-removable media implemented in any method or technology for storage of information, such as computer readable instructions, data structures, program modules, or other data. Examples of computer-readable storage media include RAM, ROM, EEPROM, flash memory, or other memory technology, CD-ROM, digital versatile disks (“DVD”) or other optical storage, magnetic cassettes, magnetic tape, magnetic disk storage or other magnetic storage devices, or any other medium which can be used to store the desired information and which can be accessed by a computing device.

Communication methods provide another type of computer readable media; namely communication media. Communication media typically embodies computer-readable instructions, data structures, program modules, or other data in a modulated data signal such as a carrier wave, data signal, or other transport mechanism and include any information delivery media. The terms “modulated data signal,” and “carrier-wave signal” includes a signal that has one or more of its characteristics set or changed in such a manner as to encode information, instructions, data, and the like, in the signal. By way of example, communication media includes wired media such as twisted pair, coaxial cable, fiber optics, wave guides, and other wired media and wireless media such as acoustic, RF, infrared, and other wireless media.

The display 306 can be any suitable display device, such as a monitor, screen, display, or the like, and can include a printer. The input device 308 can be, for example, a keyboard, mouse, touch screen, track ball, joystick, voice recognition system, or any combination thereof, or the like.

One or more imaging systems 310 can be used including, but not limited to, MRI, CT, ultrasound, or other imaging systems. The imaging system 310 may communicate through a wired or wireless connection with the computing device 300 or, alternatively or

additionally, a user can provide images from the imaging system 310 using a computer-readable medium or by some other mechanism.

The electrical stimulation system 312 can include, for example, any of the components illustrated in Figure 1. The electrical stimulation system 312 may  
5 communicate with the computing device 300 through a wired or wireless connection or, alternatively or additionally, a user can provide information between the electrical stimulation system 312 and the computing device 300 using a computer-readable medium or by some other mechanism. In some embodiments, the computing device 300 may include part of the electrical stimulation system, such as, for example, the IPG, CP, RC,  
10 ETS, or any combination thereof.

The methods and systems described herein may be embodied in many different forms and should not be construed as limited to the embodiments set forth herein. Accordingly, the methods and systems described herein may take the form of an entirely hardware embodiment, an entirely software embodiment or an embodiment combining  
15 software and hardware aspects. Systems referenced herein typically include memory and typically include methods for communication with other devices including mobile devices. Methods of communication can include both wired and wireless communications methods. Wired communication can include communication over a twisted pair, coaxial cable, fiber optics, wave guides, or the like, or any combination  
20 thereof. Wireless communication can include RF, infrared, optical, acoustic, near field communication, Bluetooth™, or the like, or any combination thereof.

It would be useful to determine desirable regions for delivery of electrical stimulation to provide a therapeutic effect or to determine regions to avoid stimulating to reduce or avoid a side effect. In at least some instances, when an electrical stimulation lead is  
25 implanted in a patient, the patient undergoes an assessment in which different sets of stimulation parameters are tested and assessed based on some rating scale (for example, the Unified Parkinson's Disease Rating Scale (UPDRS)).

In addition, in at least some instances, the location of the implanted lead within the patient's body can be determined using postoperative imaging (for example, by a CT  
30 scan). The location of the lead, and its corresponding electrodes, and the stimulation

parameters can be used to estimate the volume of tissue that is stimulated using those parameters.

This data from a single patient or from multiple patients can be evaluated to identify which portions of body (for example, portions of the brain), when electrically  
5 stimulated, are likely to affect at least one symptom of a treated condition or disorder or produce a stimulation effect or produce a stimulation side effect. When data from multiple patients is evaluated, the patients may be drawn from the general population or can be selected based on one or more criteria including, but not limited to, the condition or disorder being treated, age, gender, residence, weight, ethnicity, nationality, or the like  
10 or any combination thereof.

By understanding which portions of the body, when electrically stimulated, are likely to produce an effect on a symptom, some other stimulation effect, or a side effect, a practitioner can select stimulation parameters that are likely to stimulate (or not simulate) a portion of the body. It will be recognized that these parameters represent estimates and,  
15 when implemented, may be revised or modified upon actual testing in the patient's body.

The present invention is directed, at least in part, to evaluating data from patients to predict which portions of the body can be stimulated to produce an effect on a symptom, a stimulation effect, or a stimulation side effect. In some embodiments, a permutation test can be used to evaluate multiple actual stimulation instances and  
20 associated scores to evaluate which portions of the body are likely to produce an effect on a symptom, a stimulation effect, or a side effect when stimulated.

Figure 4 outlines one embodiment of a method for identifying portions of a body in which electrical stimulation to treat a condition or disorder is likely to affect at least one symptom, stimulation effect, or stimulation side effect. In step 402, multiple actual  
25 stimulation instances are obtained. In at least some embodiments, each stimulation instance includes a set of stimulation parameters (for example, pulse width, pulse duration, pulse frequency, pulse amplitude, and the like), values for those stimulation parameters, and at least one score directed toward at least one symptom, stimulation effect, or stimulation side effect. As used herein, the term "stimulation parameter" is used  
30 to indicate the a categorization of a parameter and the terms "stimulation parameter

value” or “value” are used to indicated the actual value (for example, a numerical value) for the particular stimulation parameter.

In at least some embodiments, each stimulation instance includes the same stimulation parameters, although one or more of the stimulation parameter values may be different. In other embodiments, a different set of stimulation parameters may be associated with one or more of the stimulation instances. For example, some stimulation instances may include a stimulation pulse width while other stimulation instances fail to include the stimulation pulse width.

In at least some embodiments, each stimulation instance includes score(s) for the same symptom(s), stimulation effect(s), or stimulation side effect(s). In other embodiments, different stimulation instances may have score(s) for different sets of symptom(s), stimulation effect(s), or stimulation side effect(s).

The stimulation instances can be from a single patient or can be from multiple patients. In at least some embodiments, each stimulation instance is directed to treating the same condition or disorder. In other embodiments, different stimulation instances may be directed to treating different conditions or disorders which may be related or unrelated.

In step 404, the stimulation parameters of each stimulation instance are used to estimate a region of the body that is stimulated by these stimulation parameters. These estimates can include, for example, estimates of axonal activation, estimates of cell bodies that are activated, estimates of fiber pathways that are activated, and the like or any combination thereof. In at least some instances, the estimate is called a value of activation (VOA) or stimulation field model (SFM) Examples of suitable methods for making these estimations include, but are not limited to, those described in U.S. Patents Nos. 8,326,433; 8,675,945; 8,831,731; 8,849,632; and 8,958,615; U.S. Patent Application Publications Nos. 2009/0287272; 2009/0287273; 2012/0314924; 2013/0116744; 2014/0122379; and 2015/0066111; and U.S. Provisional Patent Application Serial No. 62/030,655, all of which are incorporated herein by reference.. It will be understood that other methods of estimating the stimulation region that do not use the stimulation parameters can also be employed.

In other embodiments, the stimulation instances are provided to the system with an indication of the stimulation region. In such embodiments, the system may not need to computer or estimate the stimulation regions.

As the stimulation regions are computed or estimated, the stimulation regions are optionally transformed to a common space using the patients' imaging data, using an anatomical atlas, or using any other suitable method for providing a common reference frame for the stimulation regions. This enables overlay of all stimulation regions for all stimulation instances into the common reference frame.

In step 406, the likelihood that stimulation of each of one or more selected portions of the body will affect a symptom, stimulation effect, or stimulation side effect is analyzed. In at least some embodiments, a body area of interest is divided into volume elements ("voxels"). Each voxel can have a same volume or the voxels can have different volumes. In some embodiments, voxels are selected so that each voxel is only associated with a single anatomical structure (for example, a single brain structure). The voxels may cover the entire area of interest or only portions of the area of interest. The voxels can be contiguous with each other or non-contiguous.

A permutation test is used to determine a likelihood whether stimulation of a particular voxel contributes to the score for a particular symptom, stimulation effect, or stimulation side effect. To illustrate one method of analyzing the likelihood that stimulation of a voxel (which correspond to a portion of the body, as described above) will affect a particular symptom, stimulation effect, or stimulation side effect using a permutation test, a matrix is created for that voxel and for that symptom, stimulation effect, or stimulation side effect. As an example, a 2 column matrix 500 can be created for each voxel for a single symptom, stimulation effect, or stimulation side effect, as illustrated in Figure 5A. Each row of this matrix corresponds to a different stimulation instance. In the illustrated example, there are N stimulation instances. The entry for each row,  $A_n$ , in the first column of this matrix is 0 or 1 depending on whether the voxel was stimulated (i.e., active) or not stimulated (i.e., inactive), respectively, for this stimulation instance. The entry for each row,  $S_n$ , in the second column is the corresponding score that indicates, for example, the improvement or worsening of the particular symptom, stimulation effect, or stimulation side effect for that stimulation

instance. It will be recognized that the rows can instead be columns and columns can then be rows. A similar matrix can be formed for each individual voxel. In addition, similar matrices can be used to investigate other symptoms, stimulation effects, or stimulation side effects.

5           A statistical analysis is performed using a permutation test to assess whether a voxel's state of activation is influential on the symptom, stimulation effect, or stimulation side effect. As an example, the permutation test proceeds as follows: the difference in average scores (or difference in scores or any other suitable measure) between the active (first column = 1) and inactive (first column = 0) states for each voxel is determined.

10       Then, the entries in the first column (or, alternatively, the second column) in the matrix are randomized to produce a new matrix 500', as illustrated in Figure 5B where x, y, z, and w are different random integers in the range from 1 to N. The difference in average scores between the "active" (first column = 1) and "inactive" (first column = 0) states is again calculated for this randomized matrix. This randomization and difference

15       determination process is repeated many times (for example, at least 100, 500, 1000, 2000, 2500, 5000, or more times). The resulting differences can be plotted as a distribution 502 of the difference in scores between the "active" states (first column = 1) and "inactive" states (first column = 0), as illustrated in Figure 5C. The permutation test is performed under the null hypothesis that "the voxel's state (active or inactive) does not influence the

20       scores". The observed value 504 of the difference between scores in the actual active and inactive state (which is the first computed difference) is compared with this distribution. If the observed value is unlikely to occur from this distribution, the null hypothesis is declared invalid (i.e. the voxel does influence the scores). If the null hypothesis is declared invalid, it is likely that the voxel does influence the scores for the selected

25       symptom, stimulation effect, or stimulation side effect. The likelihood of the observed value occurring in the distribution can be used to determine or estimate a qualitative or quantitative likelihood that the voxel influences the scores for the selected symptom, stimulation effect, or stimulation side effect.

30           A permutation test can be performed for each voxel of interest with respect to the selected symptom, stimulation effect, or stimulation side effect. This process separates voxels between those that are likely influential with respect to the selected symptom,

stimulation effect, or stimulation side effect and those that are not likely influential. One or more of the influential voxels can form a target volume for the given symptom, stimulation effect, and stimulation side effect. A threshold criterion 506, or multiple threshold criteria, (where the observed value 504 is outside the threshold criterion) can be used to extract voxels at different levels of significance.

The importance of using a permutation test here (as opposed to a t-test) is that a permutation test provides a robust, non-parametric approach to determine statistical significance of the influence of a voxel on a particular symptom, stimulation effect, and stimulation side effect.

In step 408, the this analysis of the voxels and their influence on the selected symptom, stimulation effect, stimulation side effect can be stored on a computer or other storage device and can be displayed for review by a practitioner. The process can be repeated for additional voxels and for additional symptoms, stimulation effects, or stimulation side effects. A practitioner can utilize the results of these analyses to identify portions of the body that could be stimulated to produce a desirable treatment of one or more symptoms or desirable stimulation effects or portions of the body to avoid stimulating to reduce or eliminate one or more side effects.

A user can then use the analysis of the voxels to identify a proposed stimulation region and then select stimulation parameters that will stimulate that region. In at least some embodiments, the stimulation parameters can be provided to an implantable pulse generator or external trial stimulator for generating electrical stimulation. The electrical stimulation can be provided to a patient using any suitable electrical stimulation system including the stimulation system illustrated in Figure 1.

In some embodiments, a pseudoinverse is used to evaluate multiple actual stimulation instances and associated scores to evaluate which portions of the body, when stimulated, contribute to an outcome. The outcome can represent treatment of a symptom, disease, or disorder; production of a stimulation effect; production of a stimulation side effect; or the like.

Figure 6 outlines one embodiment of a method for identifying evaluate which portions of the body, when stimulated, are likely to affect at least one symptom,

stimulation effect, or stimulation side effect. In step 602, multiple actual stimulation instances are obtained. Each stimulation instance includes a set of stimulation parameters (for example, pulse width, pulse duration, pulse frequency, pulse amplitude, and the like), values for those stimulation parameters, and at least one score directed toward an outcome such as treatment of at least one symptom, disease, or disorder; production of a stimulation effect; or production of a stimulation side effect. As used herein, the term “stimulation parameter” is used to indicate the a categorization of a parameter and the terms “stimulation parameter value” or “value” are used to indicated the actual value (for example, a numerical value) for the particular stimulation parameter.

10 In at least some embodiments, each stimulation instance includes the same stimulation parameters, although one or more of the stimulation parameter values may be different. In other embodiments, a different set of stimulation parameters may be associated with one or more of the stimulation instances. For example, some stimulation instances may include a stimulation pulse width while other stimulation instances fail to include the stimulation pulse width.

In at least some embodiments, each stimulation instance includes score(s) for the same symptom(s), stimulation effect(s), or stimulation side effect(s). In other embodiments, different stimulation instances may have score(s) for different sets of symptom(s), stimulation effect(s), or stimulation side effect(s).

20 The stimulation instances can be from a single patient or can be from multiple patients. In at least some embodiments, each stimulation instance is directed to treating the same condition or disorder. In other embodiments, different stimulation instances may be directed to treating different conditions or disorders which may be related or unrelated.

25 In step 604, the stimulation parameters of each stimulation instance are used to estimate a region of the body that is stimulated by these stimulation parameters. These estimates can include, for example, estimates of axonal activation, estimates of cell bodies that are activated, estimates of fiber pathways that are activated, and the like or any combination thereof. In at least some instances, the estimate is called a value of activation (VOA) or stimulation field model (SFM) Examples of suitable methods for

30

making these estimations include, but are not limited to, those described in U.S. Patents Nos. 8,326,433; 8,675,945; 8,831,731; 8,849,632; and 8,958,615; U.S. Patent Application Publications Nos. 2009/0287272; 2009/0287273; 2012/0314924; 2013/0116744; 2013/0116748; 2014/0122379; and 2015/0066111; and U.S. Provisional Patent  
5 Application Serial No. 62/030,655, all of which are incorporated herein by reference.. It will be understood that other methods of estimating the stimulation region that do not use the stimulation parameters can also be employed.

In other embodiments, the stimulation instances are provided to the system with an indication of the stimulation region. In such embodiments, the system may not need to  
10 computer or estimate the stimulation regions.

As the stimulation regions are computed or estimated, the stimulation regions are optionally transformed to a common space using the patients' imaging data, using an anatomical atlas, or using any other suitable method for providing a common reference frame for the stimulation regions. This enables overlay of all stimulation regions for all  
15 stimulation instances into the common reference frame.

In step 606, an analysis is preformed to identify portions of the body that, when stimulated, will likely affect a symptom, stimulation effect, or stimulation side effect. In at least some embodiments, a body area of interest is divided into volume elements ("voxels"). Each voxel can have a same volume or the voxels can have different  
20 volumes. In some embodiments, voxels are selected so that each voxel is only associated with a single anatomical structure (for example, a single brain structure). The voxels may cover the entire area of interest or only portions of the area of interest. The voxels can be contiguous with each other or non-contiguous.

To illustrate one method of analyzing which voxels (which correspond to portions  
25 of the body), when stimulated, will likely affect a particular symptom, stimulation effect, or stimulation side effect using a pseudoinverse calculation, a matrix is created with each voxel representing a column and each stimulation instance representing a row. (It will be understood that, alternatively, the voxels could be assigned as rows and the stimulation instances could be assigned as columns.) For N stimulation instances and M voxels (i.e.,  
30 portions of the body), the matrix is a N x M matrix, A, with entries  $a_{ij}$  (or a M x N matrix

with entries  $a_{ji}$  if the alternative assignment of rows and columns is used) where  $i$  is an integer ranging from 1 to  $N$  and corresponds to the  $i^{\text{th}}$  stimulation instance and  $j$  is an integer ranging from 1 to  $M$  and corresponds to a  $j^{\text{th}}$  portion of the body, as illustrated in Figure 7A. In this embodiment,  $a_{ij}$  is 0 if the  $j^{\text{th}}$  portion of the body is not stimulated during the  $i^{\text{th}}$  stimulation instance and is a non-zero value (for example, one) if the  $j^{\text{th}}$  portion of the body is stimulated during the  $i^{\text{th}}$  stimulation instance.

In addition, a one column vector,  $S$ , of the scores is generated with entries  $S_i$  which is the score (i.e., outcome) for the  $i^{\text{th}}$  stimulation instance, as illustrated in Figure 7B. Based on these definitions of  $S$  and  $A$ ,  $S=A \bullet I$ , where  $I$  is a one column influence vector which indicates that influence that stimulation of each voxel has on the observed outcomes. The influence vector can then be determined as  $I=A^+ \bullet S$ , wherein  $A^+$  is the pseudoinverse of  $A$ . Methods for calculating, estimating, or otherwise determining the pseudoinverse,  $A^+$ , of  $A$  are known and any suitable method can be used.

Figure 8A illustrates one example of a  $5 \times 4$  matrix  $A$  which represents five stimulation instances and four voxels. The matrix  $A$  has been filled out to indicate which voxels are stimulated ( $a_{ij}=1$ ) or not stimulated ( $a_{ij}=0$ ) during each stimulation instance. The example also includes a score vector  $S$  with scores  $S_1$  to  $S_5$ . Using the pseudoinverse of  $A$ , an influence vector can be obtained, as illustrated in Figure 8A. The entries in the influence vector correspond to the respective voxels and can be used to indicate which voxels are most likely to influence an overall outcome with respect to a particular symptom, stimulation effect, or stimulation side effect.

Figure 8B illustrates one example of a  $3 \times 4$  matrix  $A$  which represents three stimulation instances and four voxels. The matrix  $A$  has been filled out to indicate which voxels are stimulated ( $a_{ij}=1$ ) or not stimulated ( $a_{ij}=0$ ) during each stimulation instance. The example also includes a score vector  $S$  with scores  $S_1$  to  $S_3$ . Using the pseudoinverse of  $A$ , an influence vector can be obtained, as illustrated in Figure 8B. The entries in the influence vector correspond to the respective voxels and can be used to indicate which voxels are most likely to influence an overall outcome with respect to a particular symptom, stimulation effect, or stimulation side effect.

In step 608, the analysis of the voxels and their influence on the selected symptom, stimulation effect, stimulation side effect can be stored on a computer or other storage device and can be displayed for review by a practitioner. The process can be repeated for additional voxels and for additional symptoms, stimulation effects, or stimulation side effects. A practitioner can utilize the results of these analyses to identify portions of the body that could be stimulated to produce a desirable treatment of one or more symptoms or desirable stimulation effects or portions of the body to avoid stimulating to reduce or eliminate one or more side effects.

A user can then use the analysis of the voxels to identify a proposed stimulation region and then select stimulation parameters that will stimulate that region. In at least some embodiments, the stimulation parameters can be provided to an implantable pulse generator or external trial stimulator for generating electrical stimulation. The electrical stimulation can be provided to a patient using any suitable electrical stimulation system including the stimulation system illustrated in Figure 1.

A graphical user interface (GUI) can be used to visualize and modify one or more VOAs. Figure 9A shows a GUI 980 according to an example embodiment of the present invention. The illustrated GUI 980 is simplified for purposes of illustration and illustrates two VOAs 982a, 982b and several buttons 984, 986, 988, 990 for user interaction to activate system functions. It will be understood, however, that the GUI can include additional features including, but not limited to, one or more of a representation of patient body structures (e.g., portions of the patient brain or any other anatomical region) which may be obtained from images or represent idealized structures based on an atlas or the like; a representation of a lead or lead electrodes; additional buttons or other structures for initiating GUI functions; information regarding the patient, body structures, VOAs, stimulation parameters, or the like; and so forth. Examples of GUIs that can be modified to include the functions described herein can be found at, for example, U.S. Patents Nos. 8,326,433; 8,675,945; 8,831,731; 8,849,632; and 8,958,615; U.S. Patent Application Publications Nos. 2009/0287272; 2009/0287273; 2012/0314924; 2013/0116744; 2013/0116748; 2014/0122379; and 2015/0066111; and U.S. Provisional Patent Application Serial No. 62/030,655, all of which are incorporated herein by reference.

The displayed VOAs can be two dimensional (as illustrated in Figure 9A) or three dimensional. In at least some embodiments, the GUI is user-interactive, e.g., by point and click using an input device such as a mouse, stylus, or even the user's finger, or by keyboard manipulation, for selecting or deselecting buttons and the like.

5 The illustrated GUI includes a union button 985, an intersection button 986, a subtraction button 988, and a search button 990. Other GUIs can include any combination of these buttons and GUI elements as described in the references cited above.

10 In some embodiments, the system can allow visualization of VOA's that can be calculated based on stimulation parameters and, optionally, are associated with a patient. The VOA's can be tagged with metadata that can be searched. Examples of metadata include, but are not limited to, demographic information (e.g., gender, age, race, nationality, height, weight, or the like of a patient associated with the VOA), diagnosis, clinician notes, lead position, stimulated body structures, or the like. The VOA's from  
15 multiple patients may be maintained in a database and, at least in some systems, the VOA's may be searchable based on one or more metadata items. In at least some embodiments, the GUI 980 includes a search button 990 that initiates a search procedure that allows the user to input or select search parameters, such as the metadata indicated above, in order to find and display one or more VOAs.

20 In some embodiments, the system may also allow the user to perform operations on VOAs. For example, a GUI 980 can include a union button 984 to form the union 982c of two or more VOAs 982a, 982b (Figure 9A) as illustrated in Figure 9B, an intersection button 986 to form the intersection 982d of two or more VOAs 982a, 982b (Figure 9A) as illustrated in Figure 9C, or a subtraction button to subtract one VOA 982b  
25 (Figure 9A) from another VOA 982a (Figure 9A) to form a new VOA 982e, as illustrated in Figure 9D of a VOA, or any combination of these buttons. The resulting modified VOA can be displayed in a GUI. For example, the user may request which voxels are common to two or more VOAs and the GUI can display the intersection of the two or more VOAs. As another example, the user may request display of the union of two or  
30 more VOAs. As yet another example, the user may request the intersection of VOA A with VOA B followed by the union of this result with VOA C. In a further example, the

user may request the union of VOA A with VOA B followed by the intersection with VOA C.

In at least some embodiments, if an intersection of two or more VOAs is requested, the system may also determine and display an indication of what fraction or percentage of one or more of the VOAs remains in the intersection. In at least some  
5 embodiments, if an intersection of two or more VOAs is requested, the system may also determine and display an indication of what fraction or percentage of one or more of the VOAs is excluded from the intersection. In at least some embodiments, if one VOA is subtracted from another VOA, the system may also determine and display an indication  
10 of what fraction or percentage of one or more of the VOAs remains. In at least some embodiments, if one VOA is subtracted from another VOA, the system may also determine and display an indication of what fraction or percentage of one or more of the VOAs is removed or excluded from the result. Examples of other calculations that can be performed for combinations of VOAs can be found in U.S. Patent Application Publication  
15 No. 2013/0116748, incorporated herein by reference.

In at least some embodiments, the union, intersection, or subtraction of two or more VOAs can also be displayed with one or more anatomic structures (for example, brain structures), such as those obtained using an atlas or using images from the patient or from some other source. In at least some embodiments, if the union, intersection, or  
20 subtraction of two or more VOAs includes at least a threshold amount (for example, at least 25%, 33%, 50%, 67%, 75%, or more) of a particular anatomic structure, the resulting VOA may be modified, either automatically, manually, or with approval by the user, to include the anatomic structure.

It will be understood that the system can include one or more of the methods and  
25 GUIs described hereinabove with respect to Figures 4-9D in any combination. The methods, systems, and GUIs described herein may be embodied in many different forms and should not be construed as limited to the embodiments set forth herein. Accordingly, the methods, systems, and GUIs described herein may take the form of an entirely hardware embodiment, an entirely software embodiment or an embodiment combining  
30 software and hardware aspects. The methods described herein can be performed using

any type of processor or any combination of processors where each processor performs at least part of the process.

It will be understood that each block of the flowchart illustrations, and combinations of blocks in the flowchart illustrations and methods disclosed herein, can be implemented by computer program instructions. These program instructions may be provided to a processor to produce a machine, such that the instructions, which execute on the processor, create means for implementing the actions specified in the flowchart block or blocks disclosed herein. The computer program instructions may be executed by a processor to cause a series of operational steps to be performed by the processor to produce a computer implemented process. The computer program instructions may also cause at least some of the operational steps to be performed in parallel. Moreover, some of the steps may also be performed across more than one processor, such as might arise in a multi-processor computer system. In addition, one or more processes may also be performed concurrently with other processes, or even in a different sequence than illustrated without departing from the scope or spirit of the invention.

The computer program instructions can be stored on any suitable computer-readable medium including, but not limited to, RAM, ROM, EEPROM, flash memory or other memory technology, CD-ROM, digital versatile disks (“DVD”) or other optical storage, magnetic cassettes, magnetic tape, magnetic disk storage or other magnetic storage devices, or any other medium which can be used to store the desired information and which can be accessed by a computing device.

The above specification, examples and data provide a description of the manufacture and use of the composition of the invention. Since many embodiments of the invention can be made without departing from the spirit and scope of the invention, the invention also resides in the claims hereinafter appended.

## CLAIMS

What is claimed as new and desired to be protected by Letters Patent of the United States is:

1. A system for identifying portions of a body in which electrical stimulation of that portion of the body to treat a condition or disorder affects at least one of at least one symptom of the condition or disorder, stimulation effect, or side effect, the system comprising:

a computer processor configured and arranged to perform the following acts:

obtaining, for each of a plurality of stimulation instances, an estimation of a region of the body stimulated during the stimulation instance and a score for each of at least one symptom of the condition or disorder, stimulation effect, or stimulation side effect;

determining, for each of a plurality of portions of the body using the scores and the estimates in a permutation test, a likelihood that stimulation of that portion of the body affects at least one symptom of the condition or disorder, stimulation effect, or stimulation side effect; and

storing or displaying the determined likelihoods to identify which portions of the body, when electrically stimulated, affect the at least one of the at least one symptom of the condition or disorder, stimulation effect, or stimulation side effect.

2. The system of claim 1, wherein the acts further include obtaining the plurality of stimulation instances and, for each stimulation instance, a set of stimulation parameters.

3. The system of any one of claims 1 or 2, wherein obtaining an estimation of a region of the body stimulated during the stimulation instance comprises estimating the region of the body stimulation during the stimulation instance based on stimulation parameters used during the stimulation instance.

4. The system of any one of claims 1-3, wherein determining a likelihood comprises forming a matrix for a selected portion of the body and for a selected symptom of the condition or disorder, stimulation effect, or stimulation side effect, the matrix comprising a plurality of rows and columns, wherein one of the columns or rows corresponds to each stimulation instance, wherein, for each of a plurality of the stimulation instances, a first entry in a column or row indicates whether the selected portion of the body is stimulated in that stimulation instance and a second entry in the column or row corresponds to the score for the selected symptom of the condition or disorder, stimulation effect, or side effect for that stimulation instance.

5. The system of claim 4, wherein determining a likelihood further comprises determining a likelihood that a null hypothesis is invalid, wherein the null hypothesis is that the selected portion of the body does not influence the scores for the selected symptom of the condition or disorder, stimulation effect, or side effect.

6. The system of claim 4, wherein determining a likelihood further comprises determining a difference between scores where the preselected portion of the body is stimulated and scores where the preselected portion of the body is not stimulated.

7. The system of claim 6, wherein determining a likelihood further comprises randomizing the second entries with respect to the first entries to form a plurality of additional matrices, wherein determining a likelihood optionally further comprises generating a distribution based on the matrix and the plurality of additional matrices.

8. A system for identifying portions of a body in which electrical stimulation of that portion of the body to treat a condition or disorder affects at least one of at least one symptom of the condition or disorder, stimulation effect, or stimulation side effect, the system comprising:

a computer processor configured and arranged to perform the following acts:

obtaining N stimulation instances, wherein N is an integer greater than one, and, for each stimulation instance, an outcome score for each of at least one symptom of the condition or disorder, stimulation effect, or stimulation side effect;

selecting M portions of the body, wherein M is an integer greater than one;

estimating, for each of the N stimulation instances and for each of the M portions of the body, whether that portion of the body was stimulated during that stimulation instance;

generating a matrix, wherein the matrix is either a) a  $N \times M$  matrix with entries  $a_{ij}$  or b) a  $M \times N$  matrix with entries  $a_{ji}$ , wherein i is an integer ranging from 1 to N and corresponds to the  $i^{\text{th}}$  stimulation instance and j is an integer ranging from 1 to M and corresponds to a  $j^{\text{th}}$  portion of the body, wherein  $a_{ij}$  or  $a_{ji}$ , respectively, is 0 if the  $j^{\text{th}}$  portion of the body is not stimulated during the  $i^{\text{th}}$  stimulation instance and is a non-zero value if the  $j^{\text{th}}$  portion of the body is stimulated during the  $i^{\text{th}}$  stimulation instance;

determining a pseudoinverse of the matrix to estimate an influence of each of the M portions of the body on the outcome scores for the N stimulation instances; and

storing or displaying the estimated influences to identify which portions of the body, when electrically stimulated, affect the at least one of the at least one symptom of the condition or disorder, stimulation effect, or stimulation side effect.

9. The system of claim 8, wherein estimating, for each of the N stimulation instances and for each of the M portions of the body, whether that portion of the body was stimulated during that stimulation instance comprises estimating, for each of the N stimulation instances and for each of the M portions of the body, whether that portion of the body was stimulated during that stimulation instance based on stimulation parameters used during the stimulation instance.

10. The system of any one of claims 8 or 9, wherein obtaining N stimulation instances comprises obtaining the N stimulation instances from a plurality of patients.

11. The system of any one of claims 8-10, further comprising generating a score vector comprising the outcome scores for the N stimulation instances.

12. The system of claim 11, wherein determining a pseudoinverse of the matrix comprises determining an influence vector using the pseudoinverse and score vector, wherein each entry in the influence vector corresponds to a different portion of the body, wherein the entries of the influence vector indicate a relative influence of the corresponding portions of the body relative to the at least one symptom of the condition or disorder, stimulation effect, or stimulation side effect.

13. A system for selecting or manipulating volumes of activation for electrical stimulation, the system comprising:

a computer processor configured and arranged to perform the following acts:

presenting a graphical user interface that includes at least one user-activatable button selected from a union button, an intersection button, or a subtraction button;

displaying at least two volumes of activation; and

in response to user activation of the at least one user-activatable button, displaying a union, an intersection, or a subtraction of at least two of the at least two volumes of activation.

14. The system of claim 13, wherein the graphical user interface includes a union button, an intersection button, and a subtraction button.

15. The system of any one of claims 13 or 14, wherein the volumes of activation further contain metadata associated with the volumes of activation and the graphical user interface further comprises a search button,  
wherein the acts further include  
in response to user activation of the search button, allowing the user to indicate one or more search terms; and  
searching metadata of a set of volumes of activation using the one or more search terms to identify one or more volumes of activation with metadata corresponding to the one or more search terms.

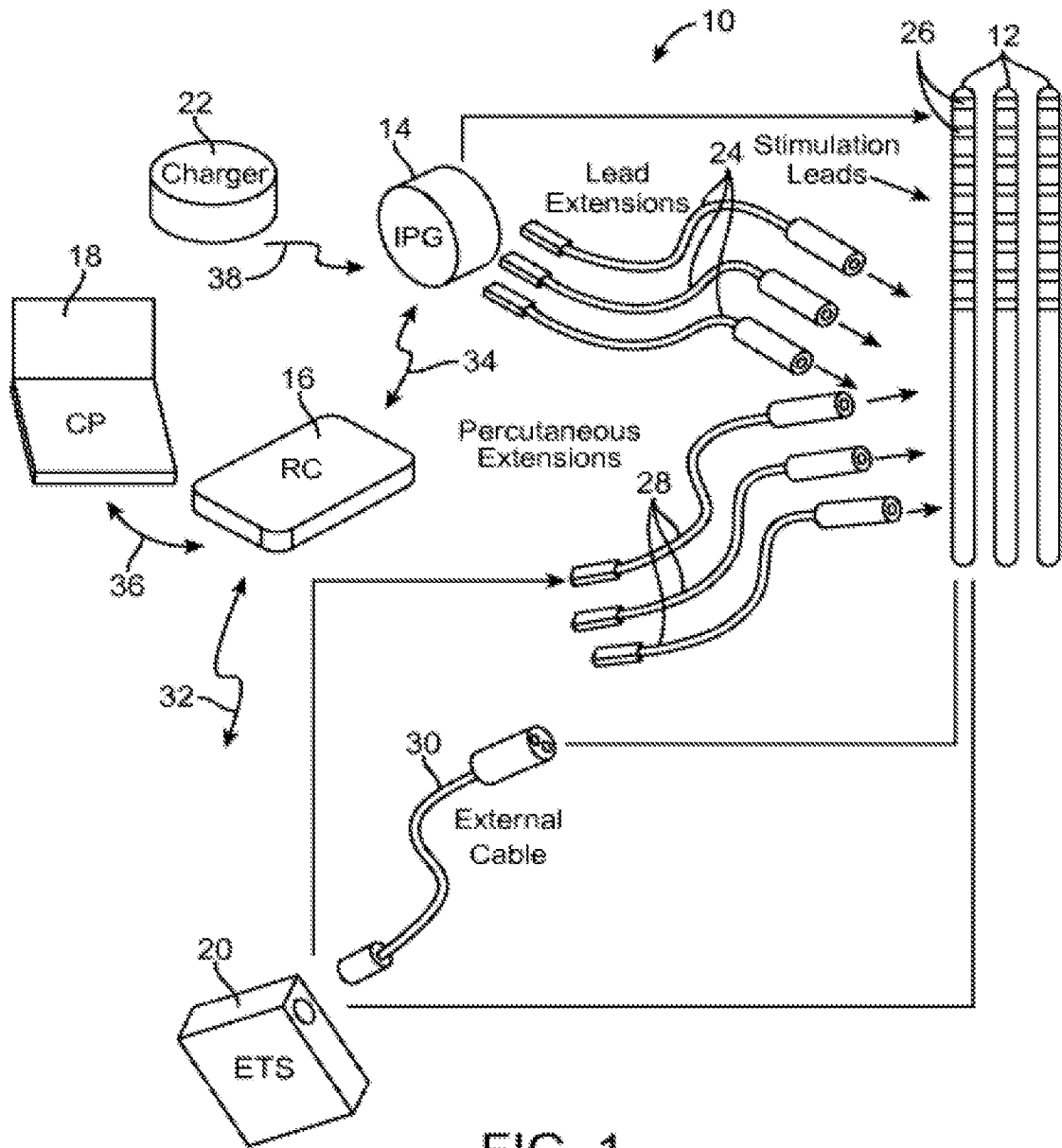
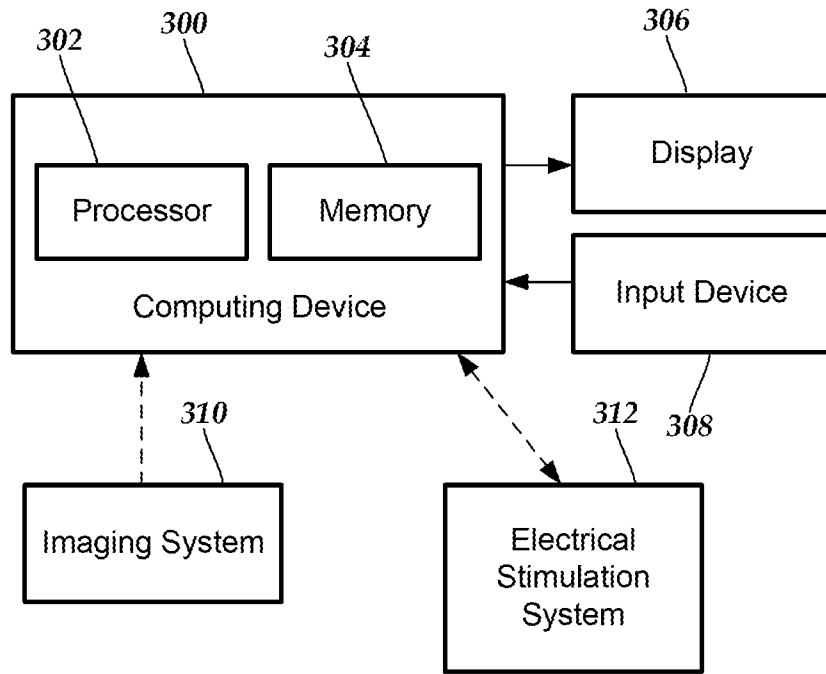
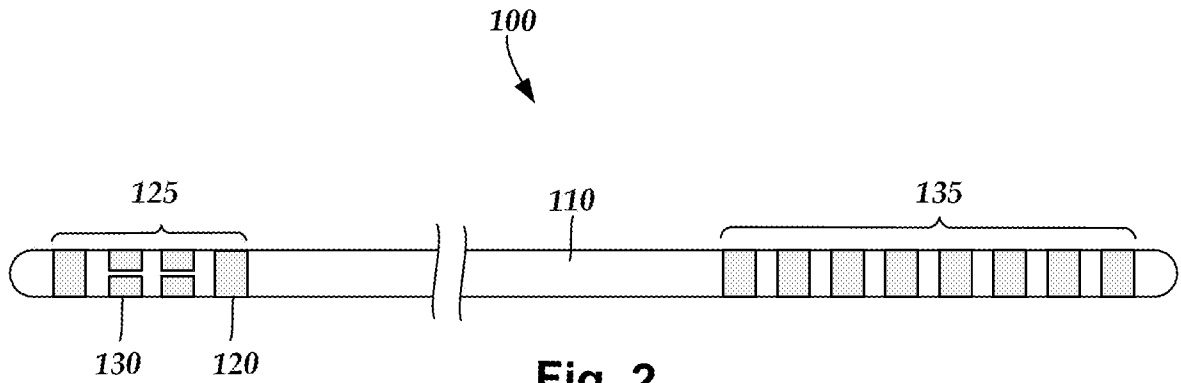
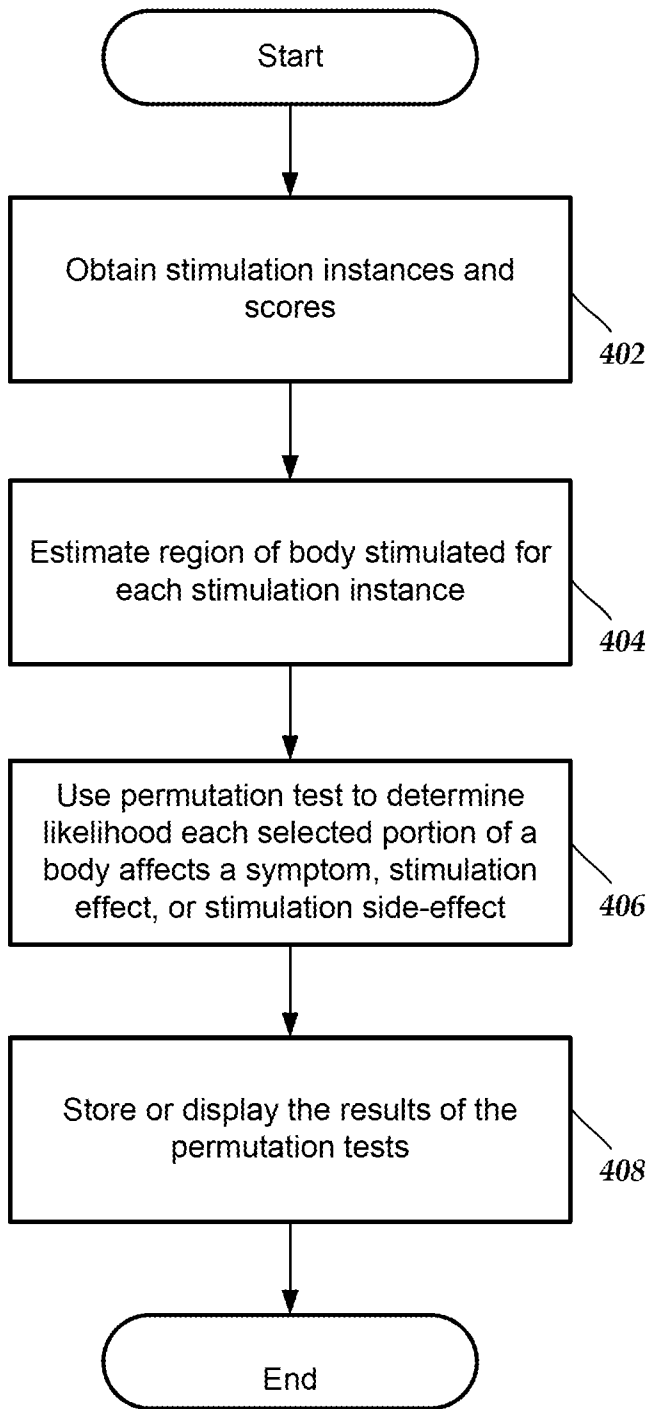


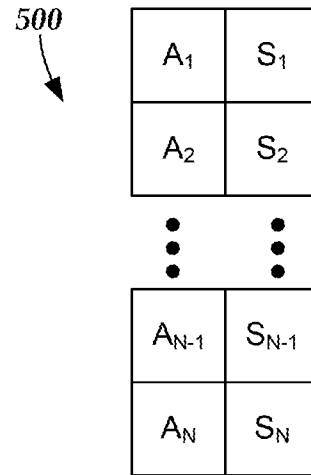
FIG. 1



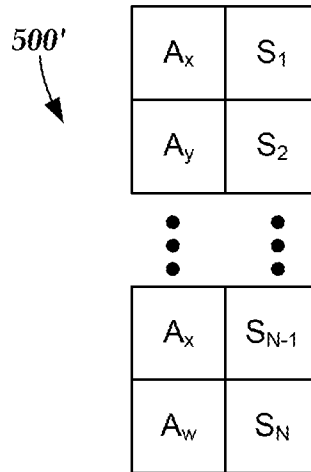
**Fig. 3**



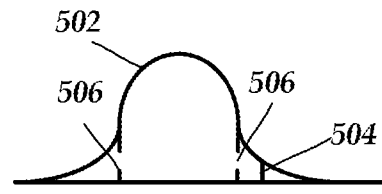
**Fig. 4**



**Fig. 5A**

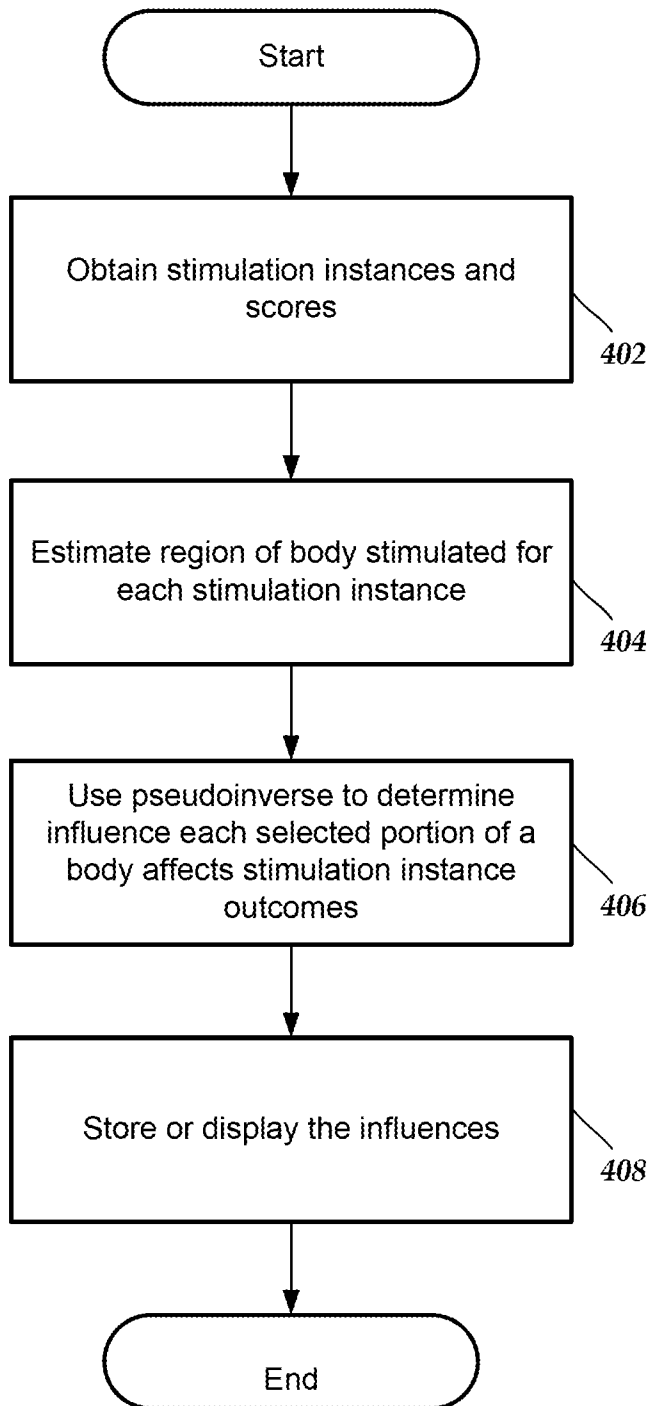


**Fig. 5B**

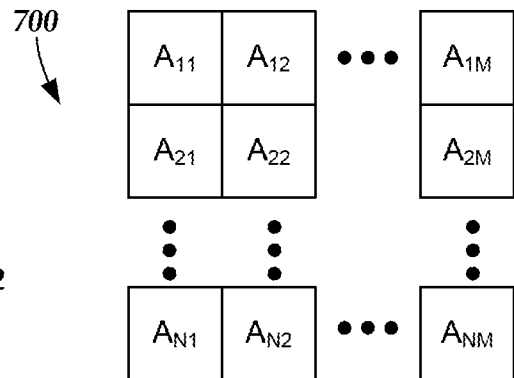


Difference

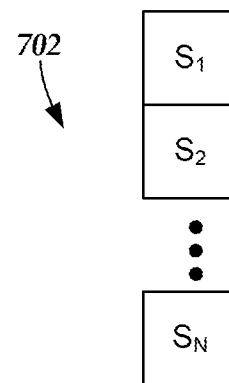
**Fig. 5C**



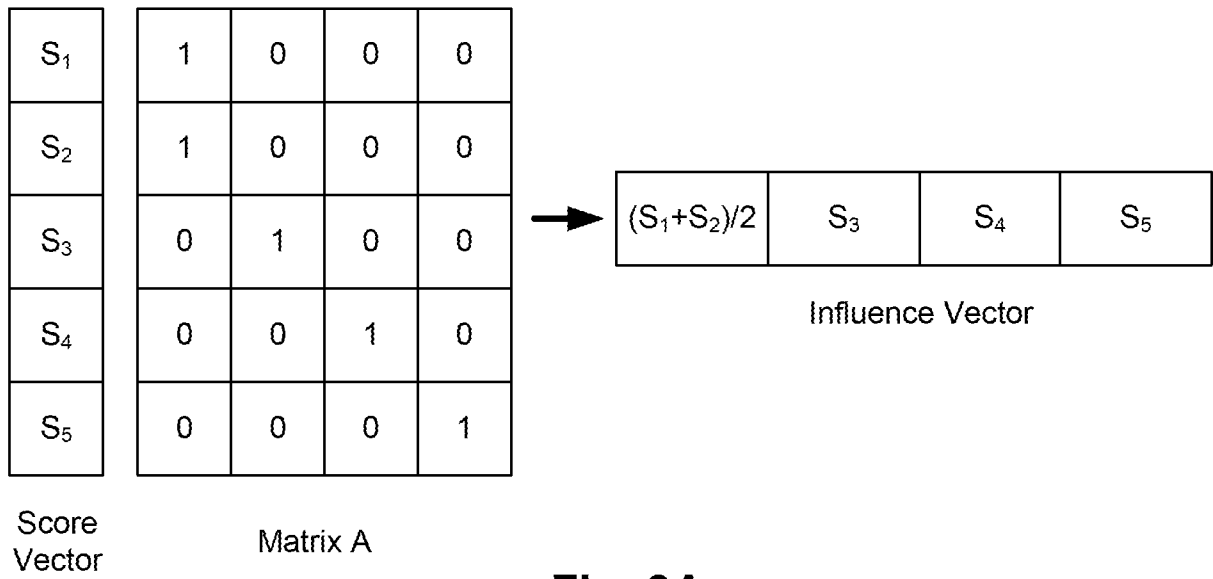
**Fig. 6**



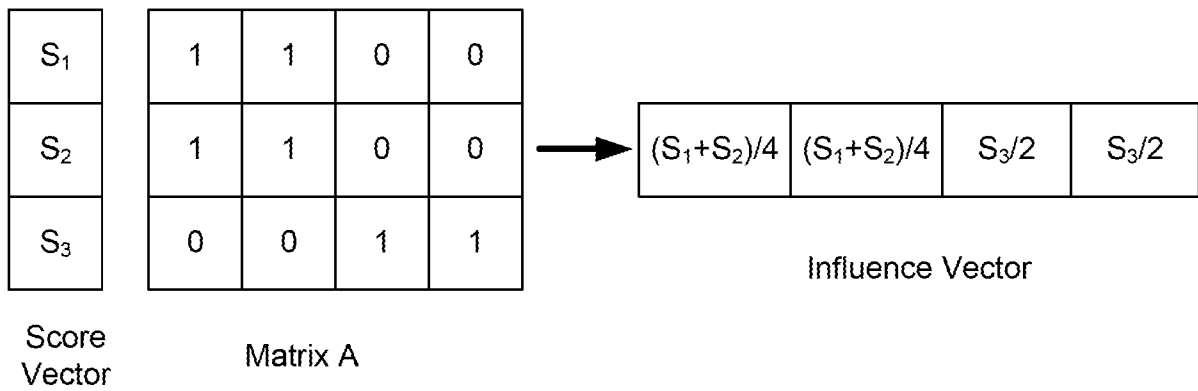
**Fig. 7A**



**Fig. 7B**



**Fig. 8A**



**Fig. 8B**

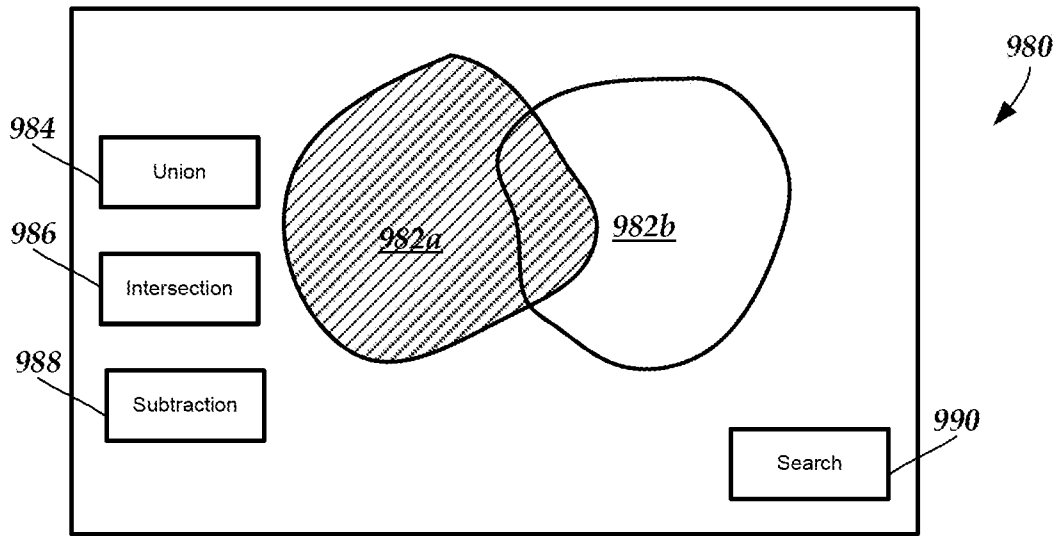


Fig. 9A

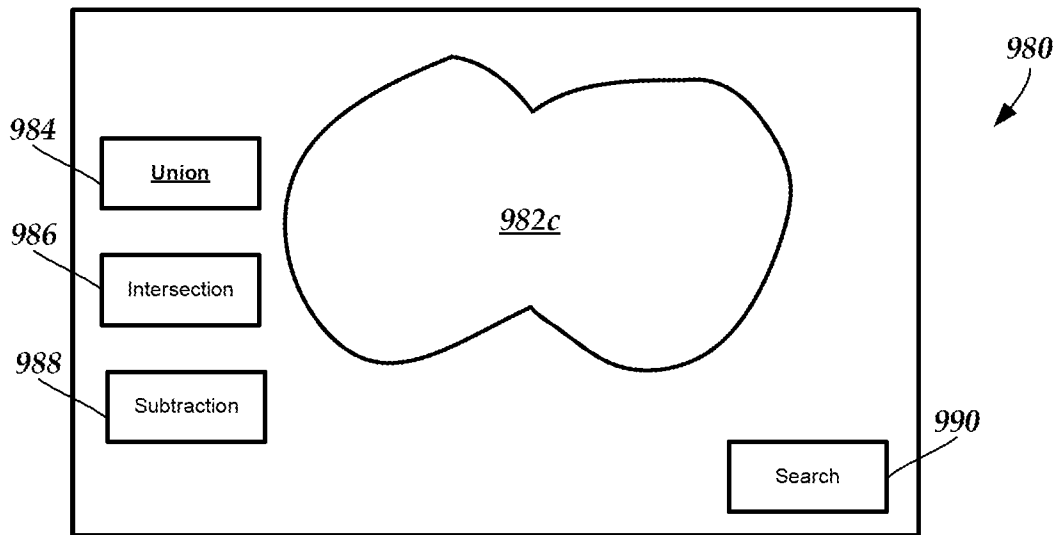


Fig. 9B

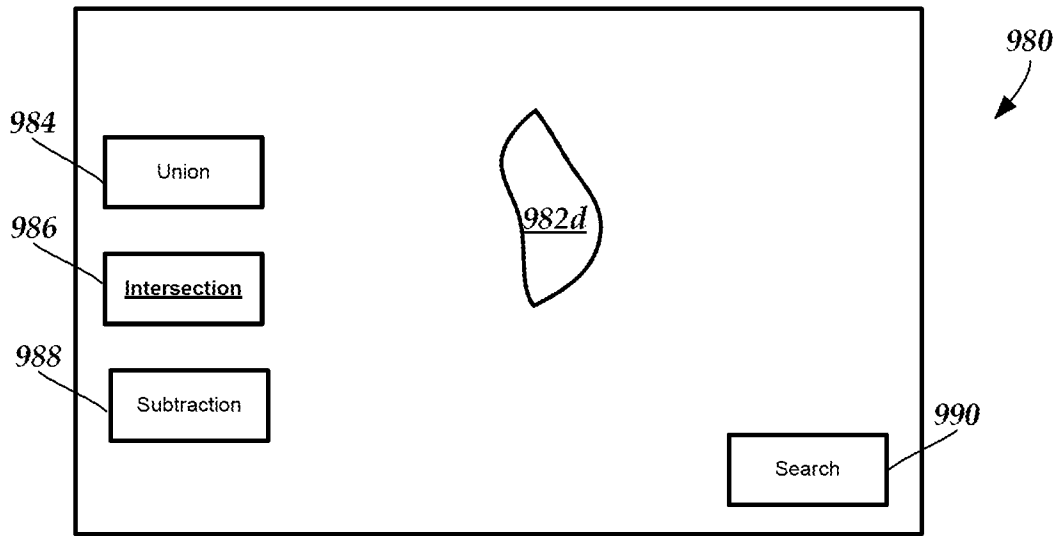


Fig. 9C

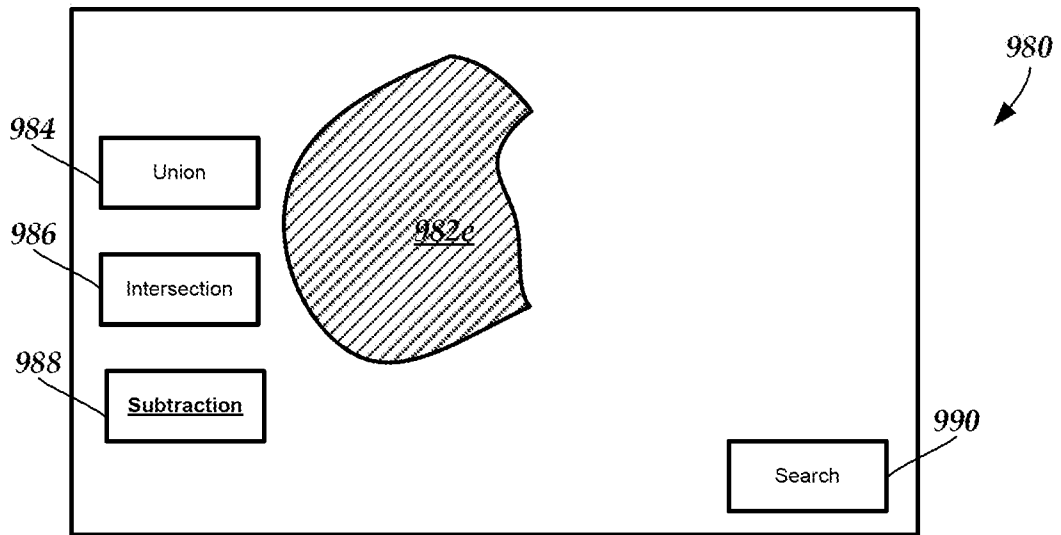


Fig. 9D

INTERNATIONAL SEARCH REPORT

International application No  
PCT/US2016/033969

A. CLASSIFICATION OF SUBJECT MATTER  
INV. A61N1/36 A61N1/372  
ADD.  
According to International Patent Classification (IPC) or to both national classification and IPC

B. FIELDS SEARCHED  
Minimum documentation searched (classification system followed by classification symbols)  
A61N  
Documentation searched other than minimum documentation to the extent that such documents are included in the fields searched

Electronic data base consulted during the international search (name of data base and, where practicable, search terms used)  
EPO-Internal, WPI Data

C. DOCUMENTS CONSIDERED TO BE RELEVANT		
Category*	Citation of document, with indication, where appropriate, of the relevant passages	Relevant to claim No.
A	WO 2014/036081 A1 (BOSTON SCIENT NEUROMODULATION [US]) 6 March 2014 (2014-03-06) abstract; figures 1,3,8-15 paragraphs [0001], [0099], [0121] - [0131]	1-7
A	US 2015/080695 A1 (ROGERS JOHN A [US] ET AL) 19 March 2015 (2015-03-19) abstract paragraph [0254]	1-7
	----- -/--	

Further documents are listed in the continuation of Box C.

See patent family annex.

\* Special categories of cited documents :

<p>"A" document defining the general state of the art which is not considered to be of particular relevance</p> <p>"E" earlier application or patent but published on or after the international filing date</p> <p>"L" document which may throw doubts on priority claim(s) or which is cited to establish the publication date of another citation or other special reason (as specified)</p> <p>"O" document referring to an oral disclosure, use, exhibition or other means</p> <p>"P" document published prior to the international filing date but later than the priority date claimed</p>	<p>"T" later document published after the international filing date or priority date and not in conflict with the application but cited to understand the principle or theory underlying the invention</p> <p>"X" document of particular relevance; the claimed invention cannot be considered novel or cannot be considered to involve an inventive step when the document is taken alone</p> <p>"Y" document of particular relevance; the claimed invention cannot be considered to involve an inventive step when the document is combined with one or more other such documents, such combination being obvious to a person skilled in the art</p> <p>"&amp;" document member of the same patent family</p>
---	---

Date of the actual completion of the international search  28 July 2016	Date of mailing of the international search report  19/10/2016
Name and mailing address of the ISA/ European Patent Office, P.B. 5818 Patentlaan 2 NL - 2280 HV Rijswijk Tel. (+31-70) 340-2040, Fax: (+31-70) 340-3016	Authorized officer  Pfeiffer, Uwe

# INTERNATIONAL SEARCH REPORT

International application No.  
PCT/US2016/033969

## Box No. II Observations where certain claims were found unsearchable (Continuation of item 2 of first sheet)

This international search report has not been established in respect of certain claims under Article 17(2)(a) for the following reasons:

1.  Claims Nos.:  
because they relate to subject matter not required to be searched by this Authority, namely:
  
2.  Claims Nos.:  
because they relate to parts of the international application that do not comply with the prescribed requirements to such an extent that no meaningful international search can be carried out, specifically:
  
3.  Claims Nos.:  
because they are dependent claims and are not drafted in accordance with the second and third sentences of Rule 6.4(a).

## Box No. III Observations where unity of invention is lacking (Continuation of item 3 of first sheet)

This International Searching Authority found multiple inventions in this international application, as follows:

see additional sheet

1.  As all required additional search fees were timely paid by the applicant, this international search report covers all searchable claims.
  
2.  As all searchable claims could be searched without effort justifying an additional fees, this Authority did not invite payment of additional fees.
  
3.  As only some of the required additional search fees were timely paid by the applicant, this international search report covers only those claims for which fees were paid, specifically claims Nos.:
  
4.  No required additional search fees were timely paid by the applicant. Consequently, this international search report is restricted to the invention first mentioned in the claims; it is covered by claims Nos.:

1-7

### Remark on Protest

- The additional search fees were accompanied by the applicant's protest and, where applicable, the payment of a protest fee.
- The additional search fees were accompanied by the applicant's protest but the applicable protest fee was not paid within the time limit specified in the invitation.
- No protest accompanied the payment of additional search fees.

## INTERNATIONAL SEARCH REPORT

International application No  
PCT/US2016/033969

C(Continuation). DOCUMENTS CONSIDERED TO BE RELEVANT		
Category*	Citation of document, with indication, where appropriate, of the relevant passages	Relevant to claim No.
A	THOMAS E. NICHOLS ET AL: "Nonparametric permutation tests for functional neuroimaging: A primer with examples", HUMAN BRAIN MAPPING, vol. 15, no. 1, 1 January 2002 (2002-01-01), pages 1-25, XP055291962, ISSN: 1065-9471, DOI: 10.1002/hbm.1058 the whole document -----	1-7

# INTERNATIONAL SEARCH REPORT

Information on patent family members

International application No

PCT/US2016/033969

Patent document cited in search report	Publication date	Patent family member(s)	Publication date
WO 2014036081 A1	06-03-2014	AU 2013308906 A1	12-03-2015
		AU 2013308910 A1	12-03-2015
		AU 2013308912 A1	12-03-2015
		EP 2890451 A2	08-07-2015
		EP 2890454 A1	08-07-2015
		EP 2891091 A1	08-07-2015
		JP 2015529521 A	08-10-2015
		US 2014066999 A1	06-03-2014
		US 2014067018 A1	06-03-2014
		US 2014067022 A1	06-03-2014
		US 2016114179 A1	28-04-2016
		US 2016151634 A1	02-06-2016
		WO 2014036075 A1	06-03-2014
		WO 2014036079 A2	06-03-2014
		WO 2014036081 A1	06-03-2014
US 2015080695 A1	19-03-2015	EP 2713863 A2	09-04-2014
		US 2013072775 A1	21-03-2013
		US 2015080695 A1	19-03-2015
		WO 2012167096 A2	06-12-2012

**FURTHER INFORMATION CONTINUED FROM PCT/ISA/ 210**

This International Searching Authority found multiple (groups of) inventions in this international application, as follows:

1. claims: 1-7

System for estimating a region of stimulation for each of a plurality of stimulation instances, and for estimating a likelihood of stimulation in each of a plurality of body portions, wherein the likelihood is estimated in a permutation test; for solving the problem of providing a significance of the estimated region of stimulation.

---

2. claims: 8-12

System for identifying portions of a body in which stimulation affects at least one symptom, wherein a matrix is generated wherein each entry is a stimulation result of one of a plurality of stimulation instances with one of a plurality of body portion; for solving the problem of estimating an influence of each of the body portions for the stimulation instances.

---

3. claims: 13-15

System for selecting or manipulating volumes of stimulation, comprising user interface with at least one button and a display for displaying at least two volumes of activation; for solving the problem of estimating cross effects.

---