



US00D919476S

(12) **United States Design Patent**  
**Shah**

(10) **Patent No.:** **US D919,476 S**

(45) **Date of Patent:** **\*\* May 18, 2021**

- (54) **PRECIOUS STONE SETTING**
- (71) Applicant: **KGS Jewels Inc.**, New York, NY (US)
- (72) Inventor: **Pranav Shah**, New York, NY (US)
- (73) Assignee: **KGS JEWELS INC.**, New York, NY (US)

D642,088 S *	7/2011	Kothari .....	D11/91
D679,215 S *	4/2013	Roehl .....	D11/91
D751,939 S *	3/2016	Vartanian .....	D11/1
D751,945 S *	3/2016	Yep .....	D11/92
D783,446 S *	4/2017	Kothari .....	D11/91
D826,081 S *	8/2018	Shah .....	D11/91
D849,594 S *	5/2019	Pereira .....	D11/92
D851,534 S *	6/2019	Bhosale .....	D11/91

\* cited by examiner

(\*\*) Term: **15 Years**

*Primary Examiner* — Llorelys Martinez

(21) Appl. No.: **29/687,503**

(74) *Attorney, Agent, or Firm* — Ostrolenk Faber LLP

(22) Filed: **Apr. 12, 2019**

(57) **CLAIM**

(51) **LOC (13) Cl.** ..... **11-01**

The ornamental design for a precious stone setting, as shown and described.

(52) **U.S. Cl.**  
USPC ..... **D11/91**

(58) **Field of Classification Search**  
USPC ..... D11/1-6, 26, 34, 79, 86, 90, 91, 92  
CPC .... A44C 17/00; A44C 17/001; A44C 17/005;  
A44C 17/02; A44C 17/0275; A44C  
17/0283; A44C 17/0291; A44C 25/001;  
A44C 1/00

**DESCRIPTION**

See application file for complete search history.

FIG. 1 is a perspective view of a precious stone setting showing my new design;  
FIG. 2 is another perspective view thereof;  
FIG. 3 is a top view thereof;  
FIG. 4 is a front side view thereof, the rear, left side and right side views being identical thereto;  
FIG. 5 is a bottom view of FIG. 1; and,  
FIG. 6 is a cross-sectional view thereof, taken along lines 6-6 in FIG. 3.

(56) **References Cited**

**U.S. PATENT DOCUMENTS**

D130,419 S *	11/1941	Schaeffer .....	D11/92
D463,754 S *	10/2002	Pinto .....	D11/91

**1 Claim, 6 Drawing Sheets**

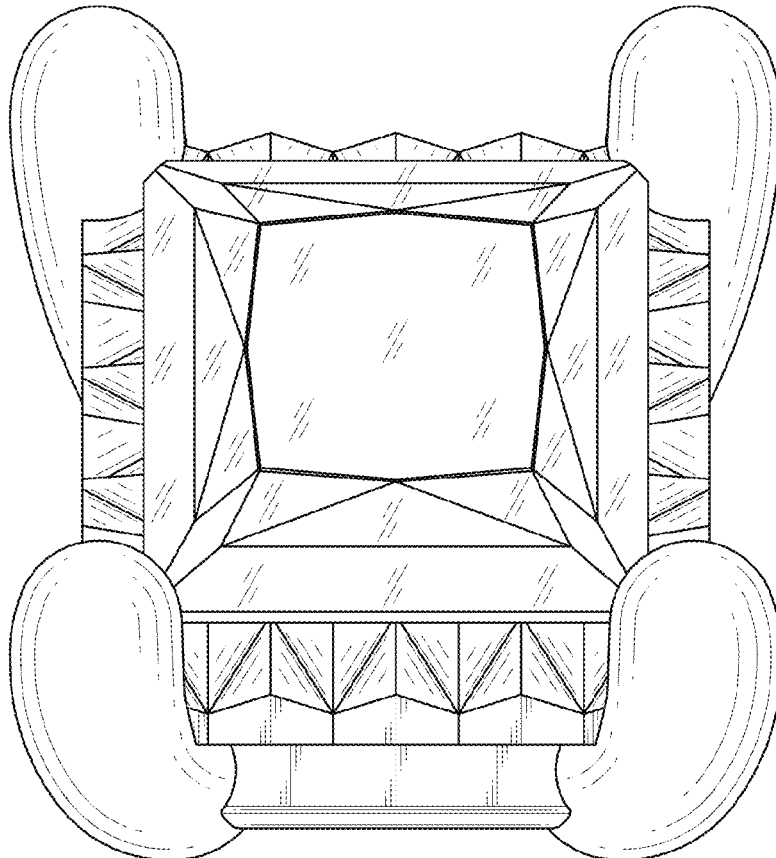

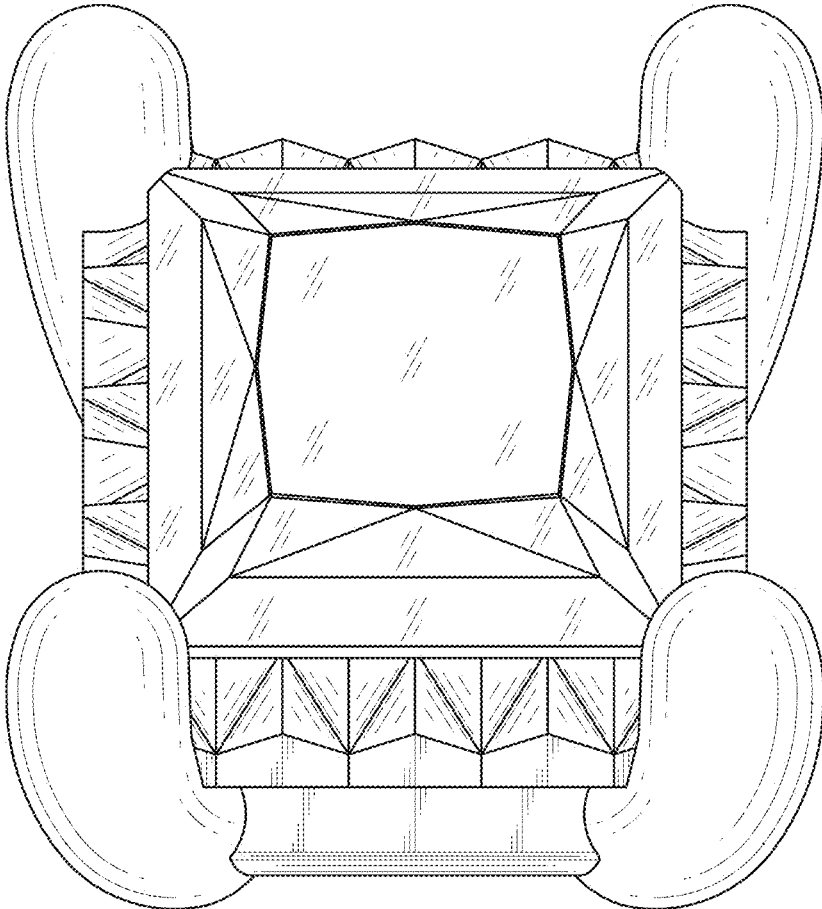

FIG. 1

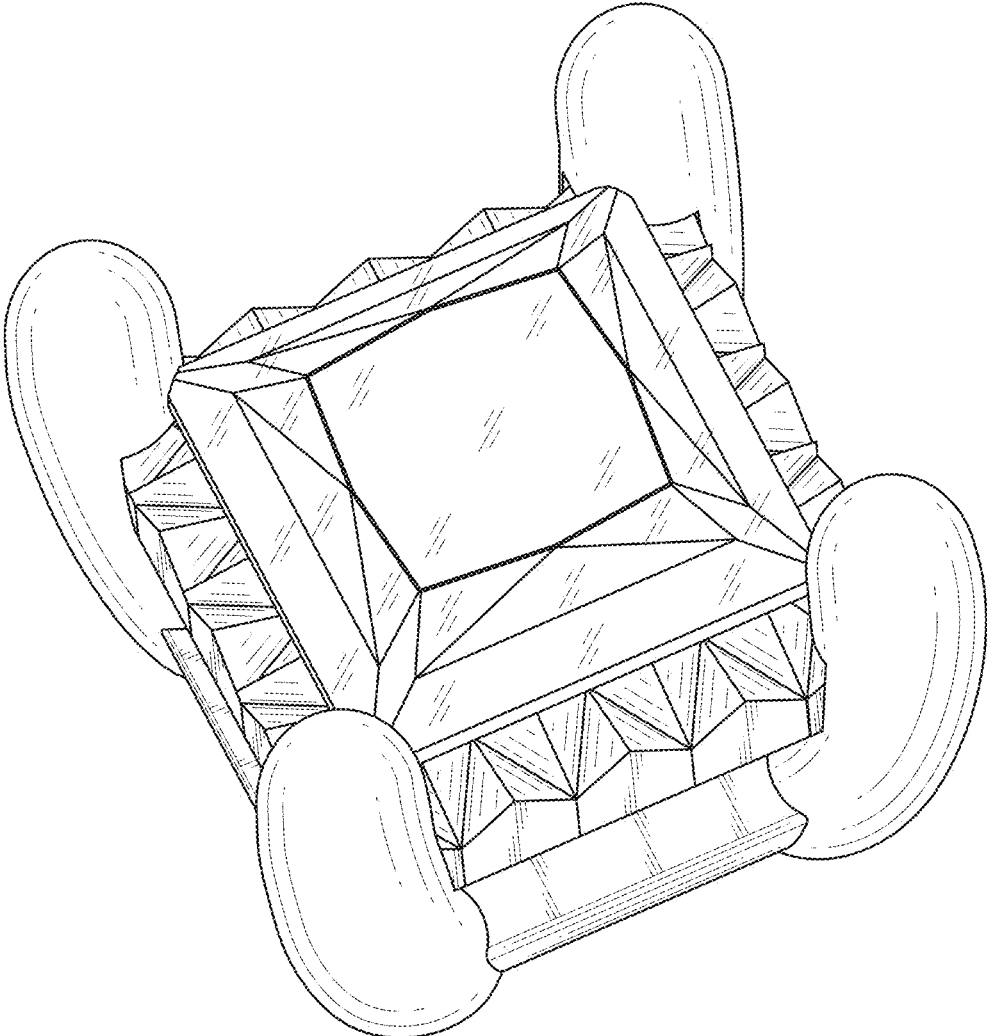

FIG. 2

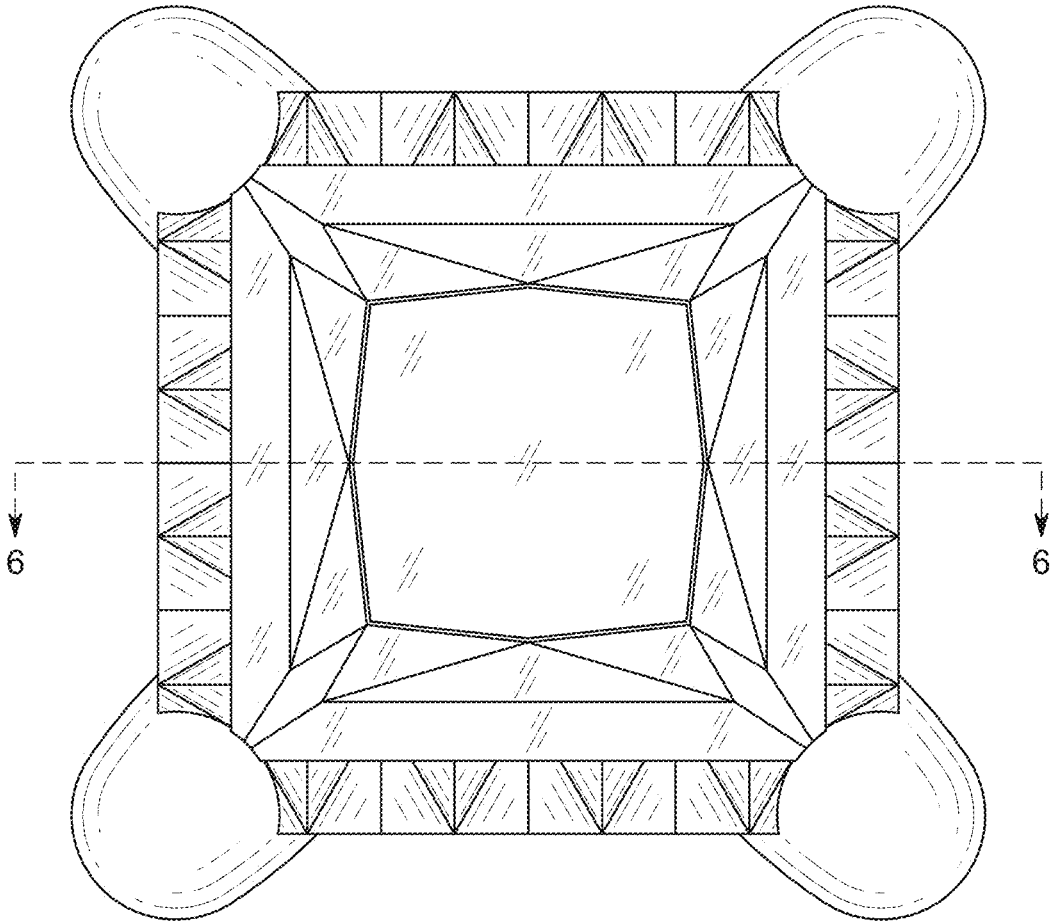

FIG. 3

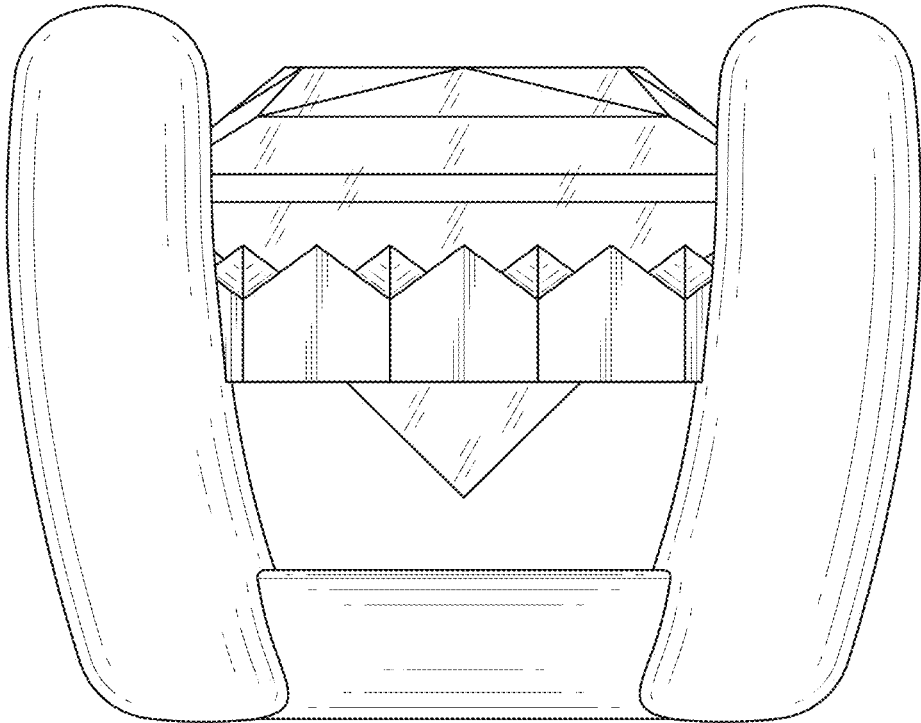

FIG. 4

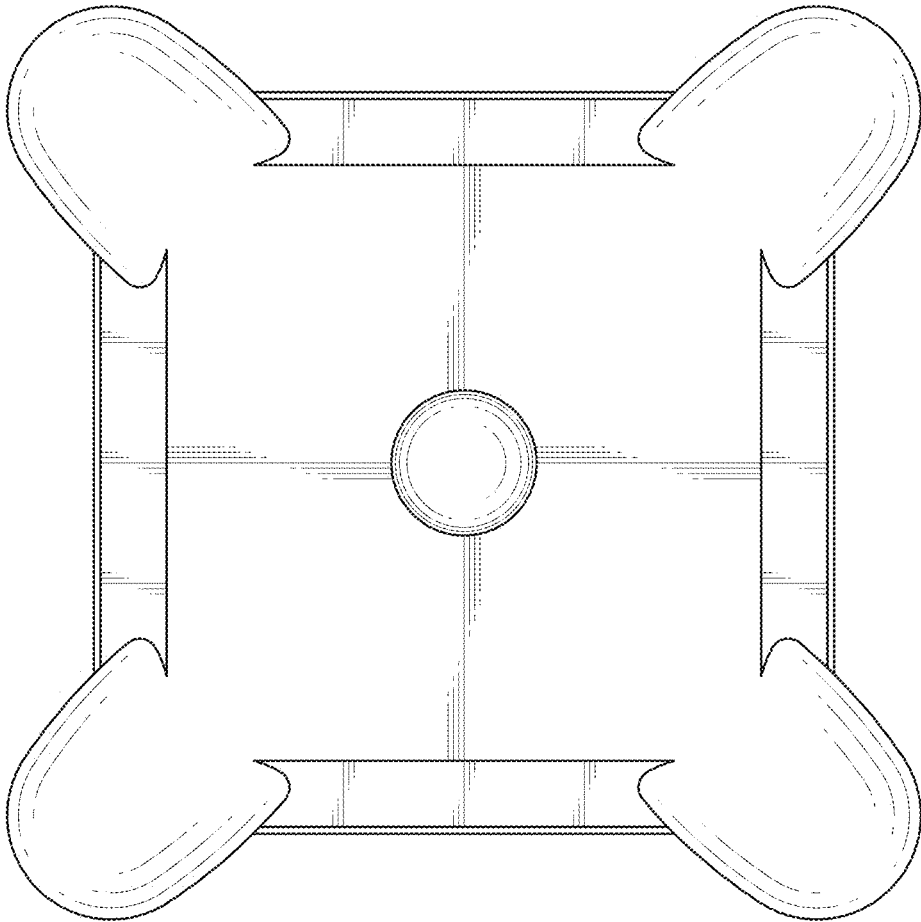

FIG. 5

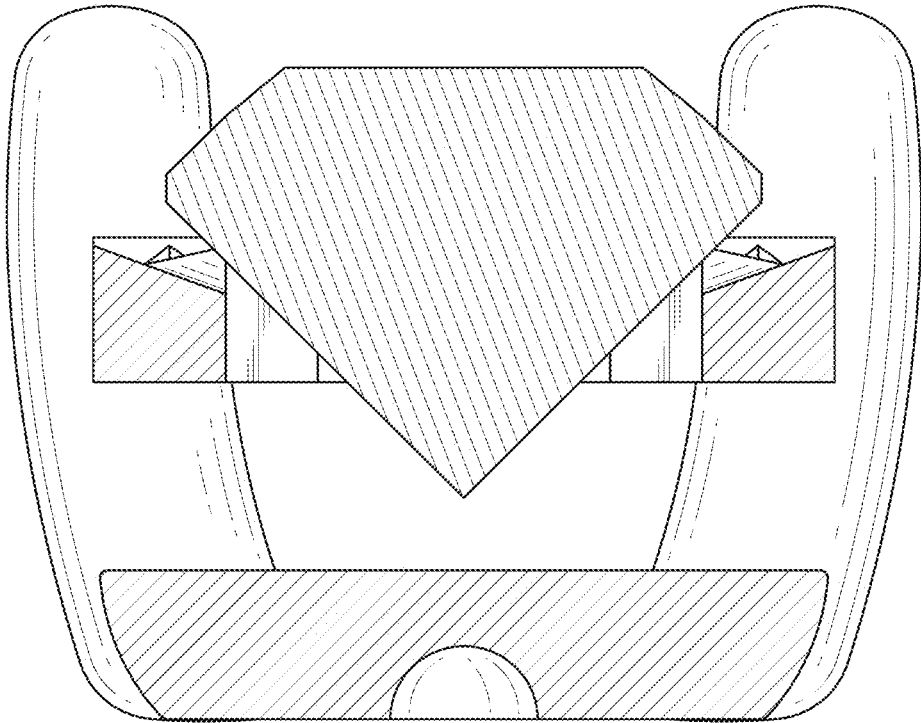

FIG. 6