



US00D457882S

(12) **United States Design Patent** (10) **Patent No.:** **US D457,882 S**  
**Harczstark** (45) **Date of Patent:** **\*\* May 28, 2002**

(54) **COMPUTER**

(75) Inventor: **Harry J. Harczstark**, Teaneck, NJ (US)

(73) Assignee: **Advanced Medical Technologies, Inc.**, Kearny, NJ (US)

(\*\*) Term: **14 Years**

(21) Appl. No.: **29/135,630**

(22) Filed: **Jan. 16, 2001**

(51) **LOC (7) Cl.** ..... **14-02**

(52) **U.S. Cl.** ..... **D14/337**

(58) **Field of Search** ..... D14/335-337, D14/371, 374, 126-129; 345/104, 133, 156, 168, 173; 348/180, 184, 325; 349/1, 2, 11, 62

(56) **References Cited**

**U.S. PATENT DOCUMENTS**

D311,907 S \* 11/1990 Yoshihara ..... D14/337

5,594,471 A \* 1/1997 Deeran et al. .... 345/173  
D396,217 S \* 7/1998 Suzuki et al. .... D14/336  
D404,761 S \* 1/1999 Tarpenning et al. .... D14/341

\* cited by examiner

*Primary Examiner*—Freda Nunn

(74) *Attorney, Agent, or Firm*—Norman E. Lehrer

(57) **CLAIM**

The ornamental design for a computer, as shown and described.

**DESCRIPTION**

FIG. 1 is a front elevational view of a "computer" showing my new design;

FIG. 2 is a top plan view thereof;

FIG. 3 is a bottom plan view thereof;

FIG. 4 is a left side elevational view thereof;

FIG. 5 is a right side elevational view thereof; and,

FIG. 6 is a rear top right side perspective view thereof.

**1 Claim, 2 Drawing Sheets**

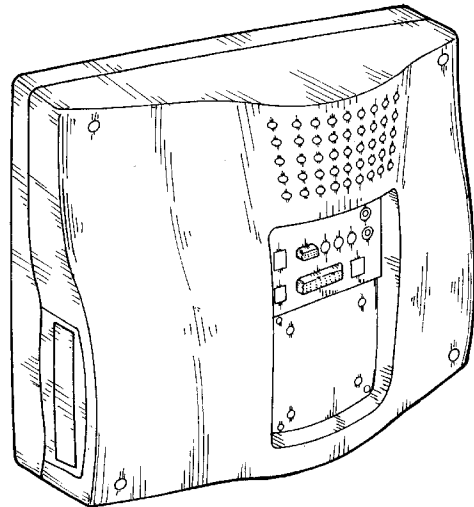
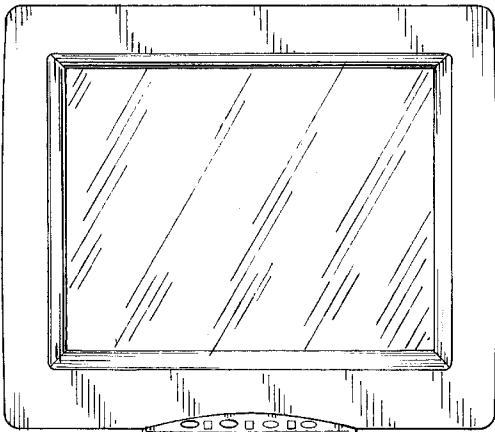

*Fig. 1*

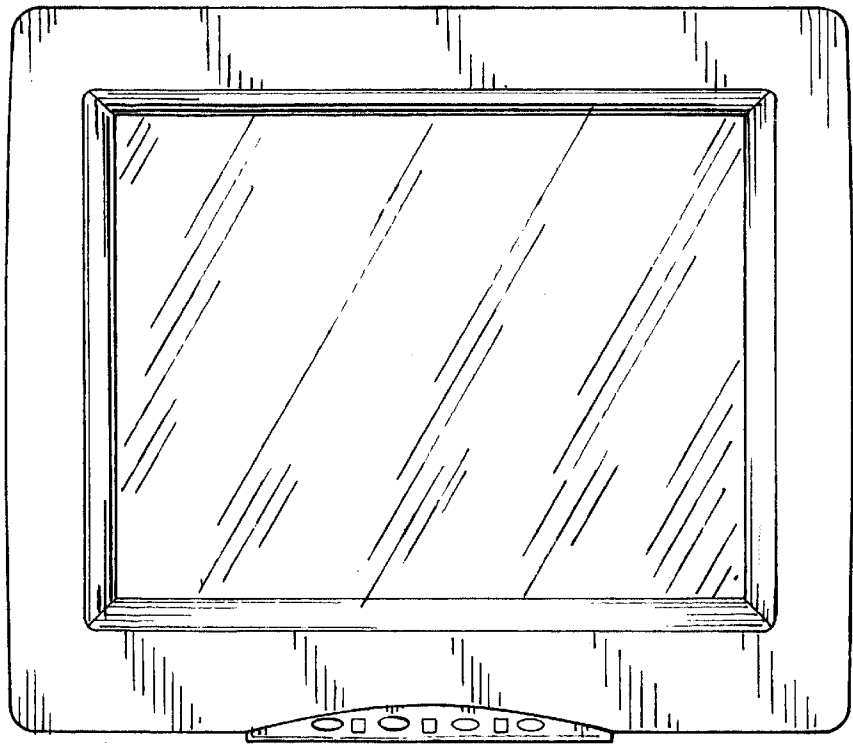

*Fig. 2*

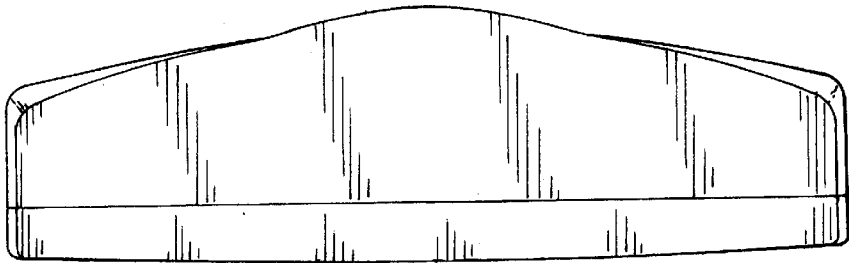

*Fig. 3*

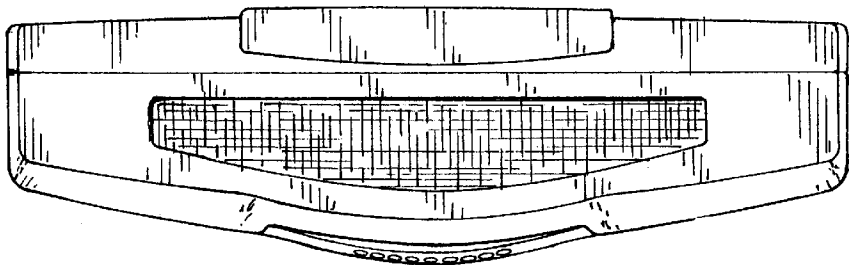

*Fig. 4*

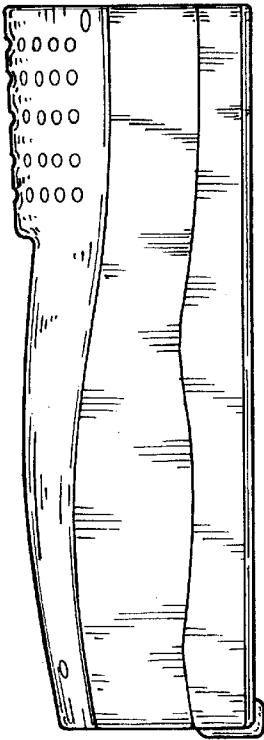

*Fig. 5*

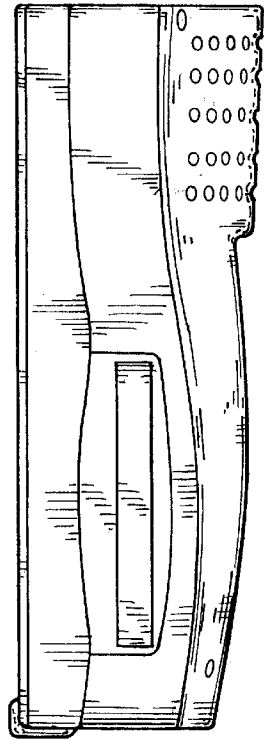

*Fig. 6*

