

FIGURE 1A

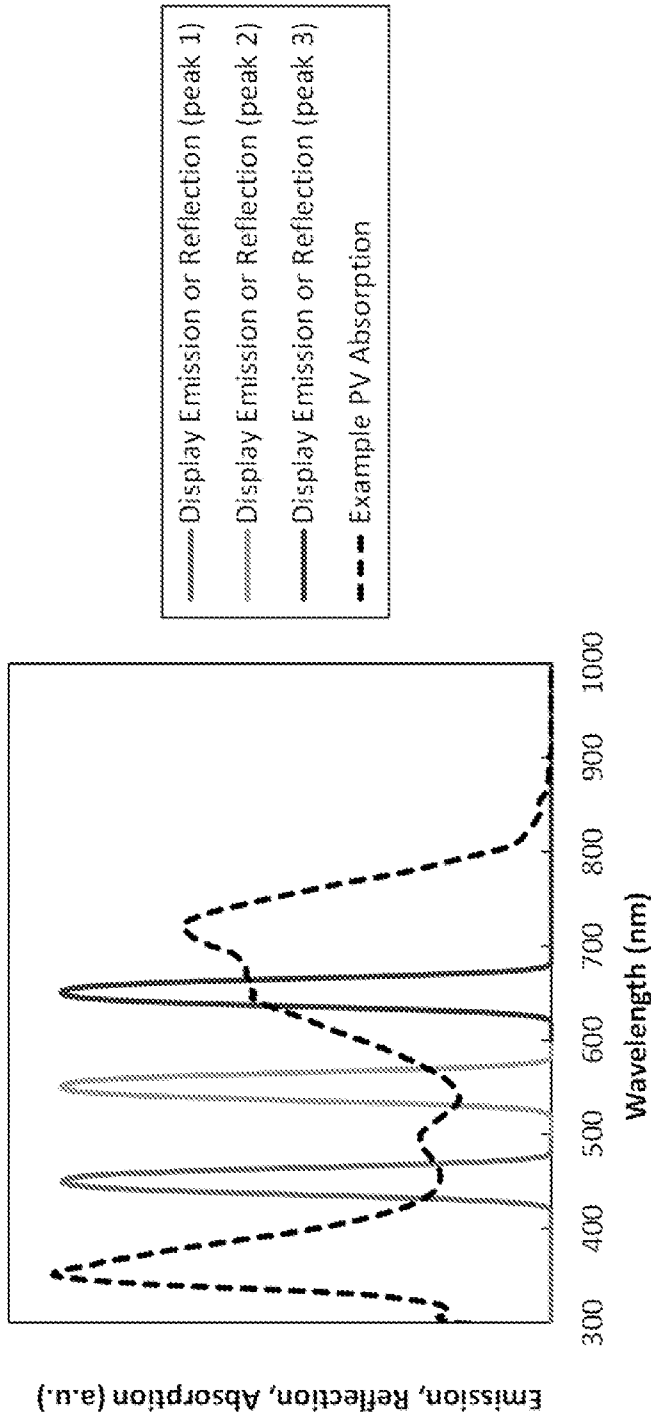

FIGURE 1B

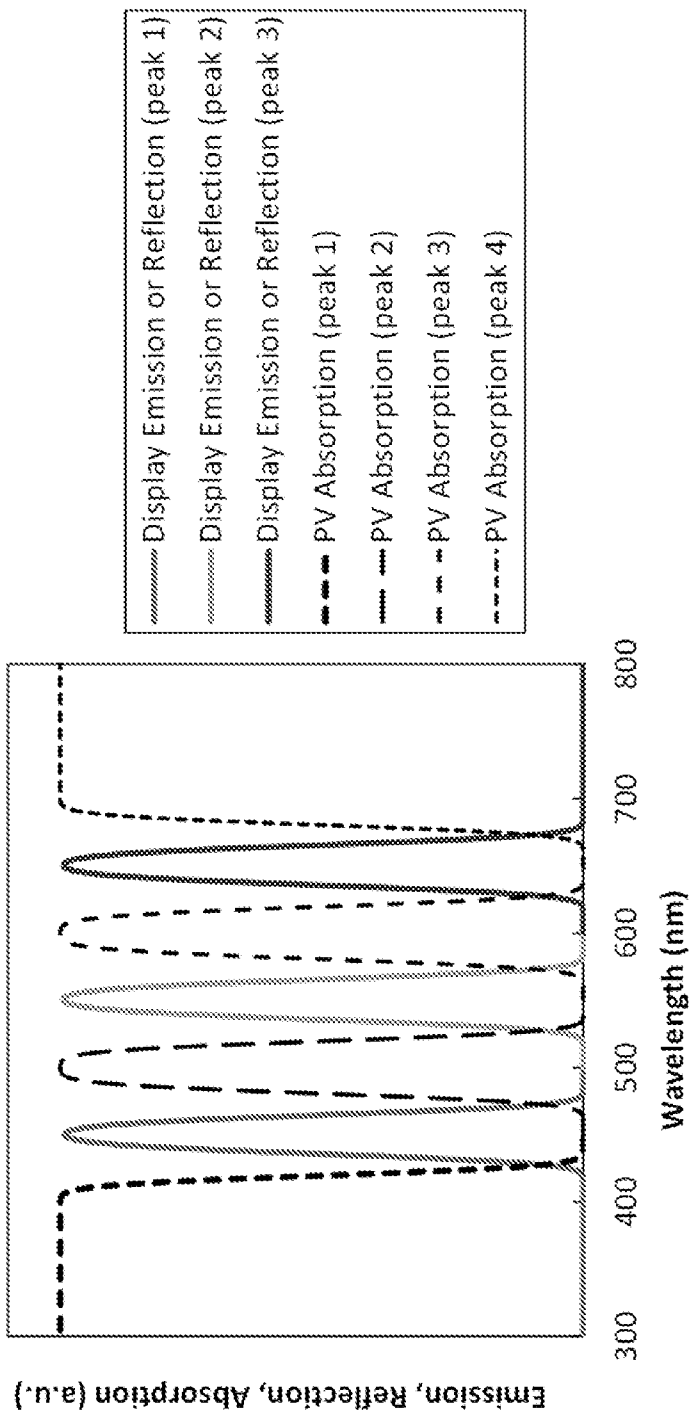

FIGURE 1C

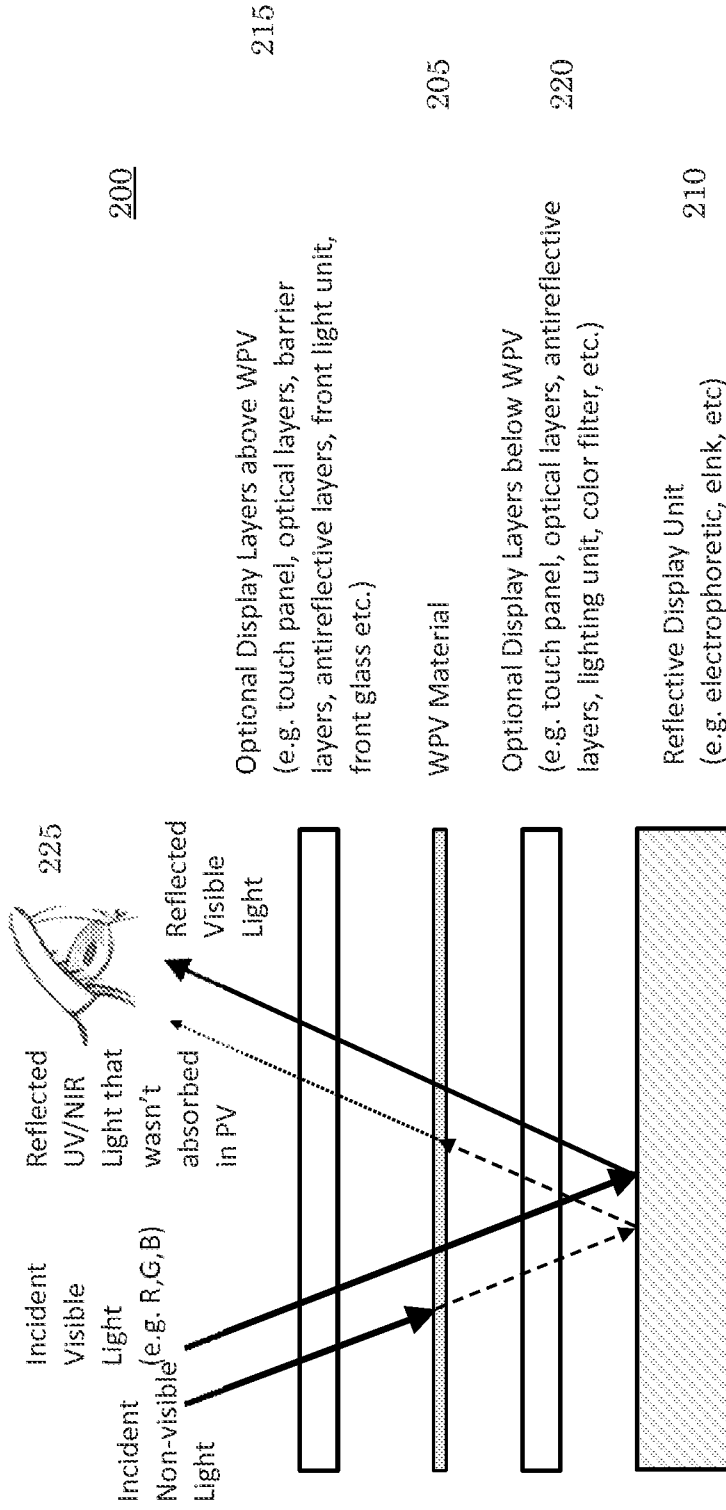

FIGURE 2

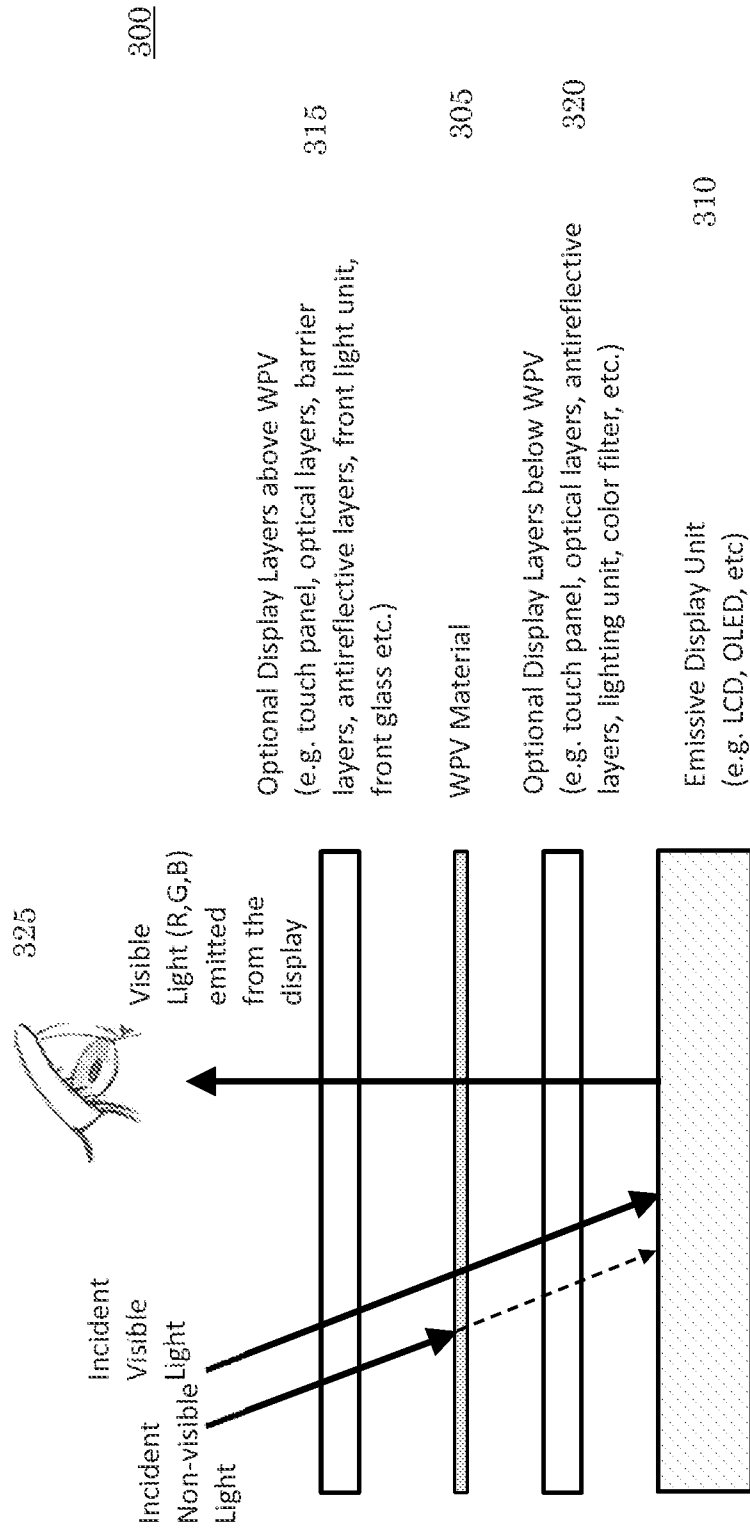

FIGURE 8A

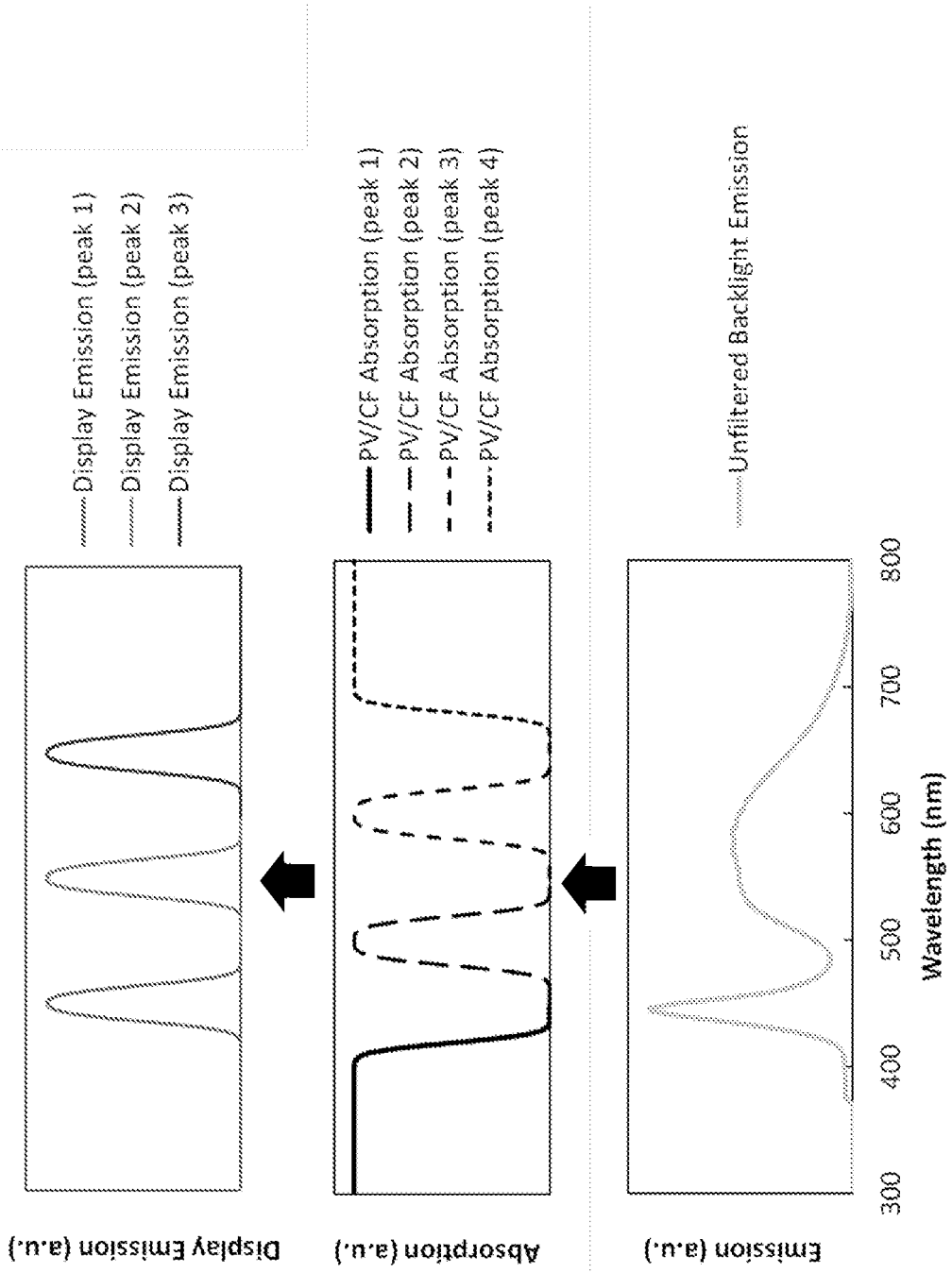

FIGURE 3B

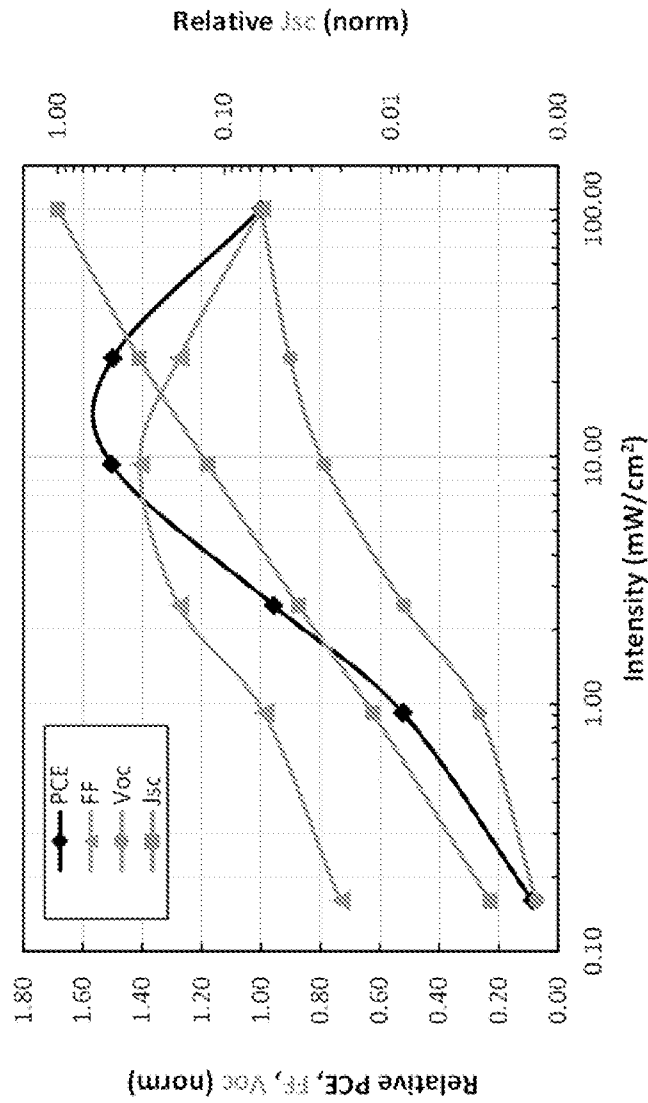

FIGURE 4

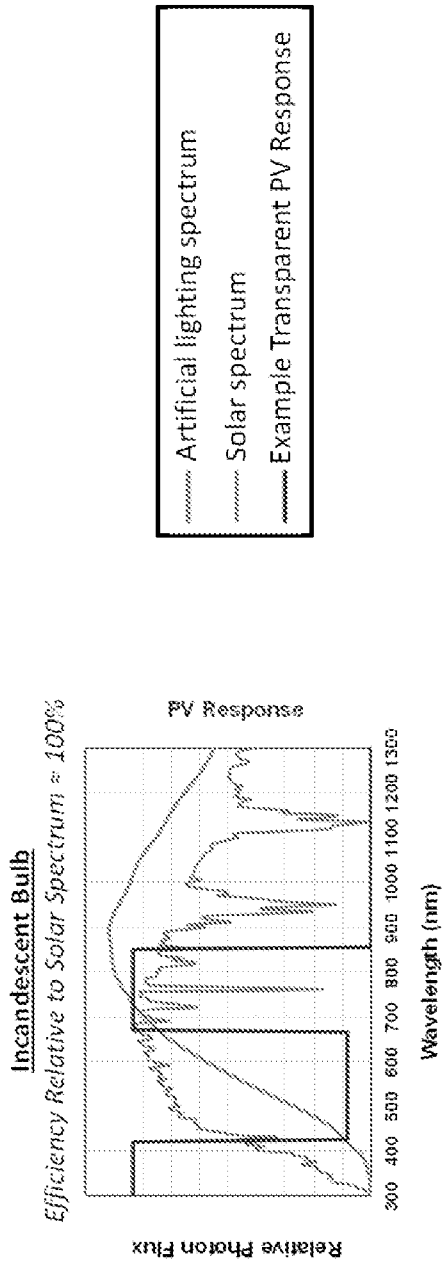

FIGURE 5A

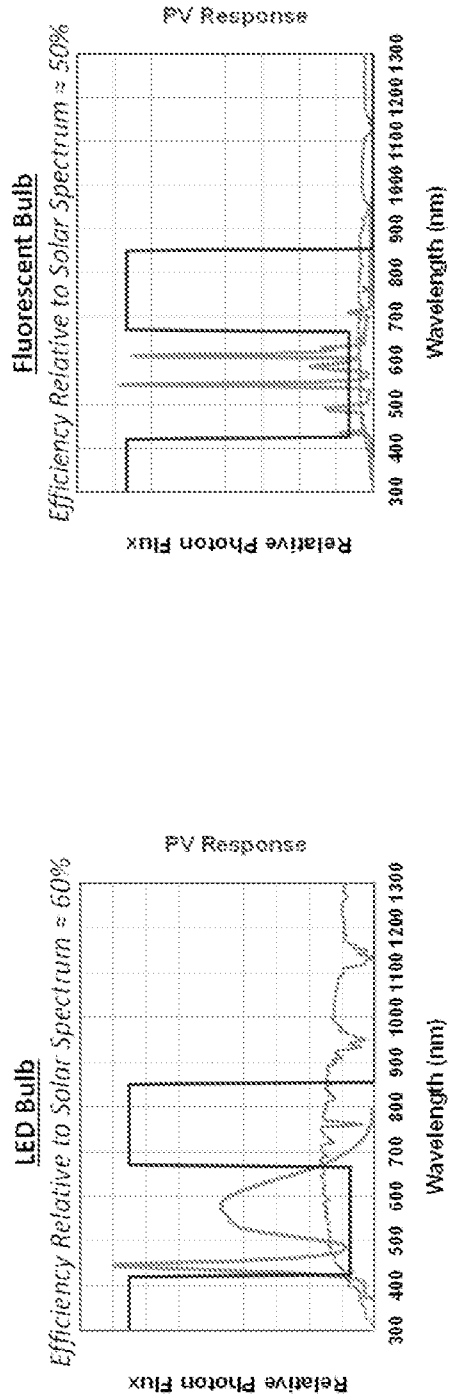

FIGURE 5C

FIGURE 5B



FIGURE 6B

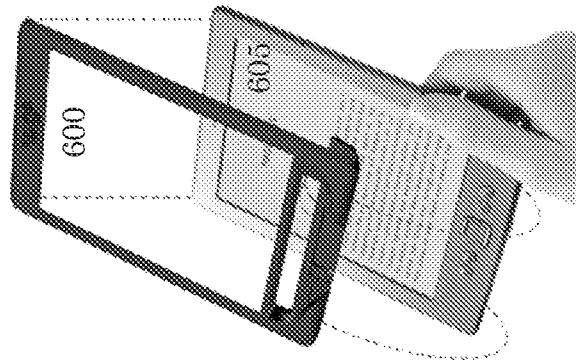

FIGURE 6A

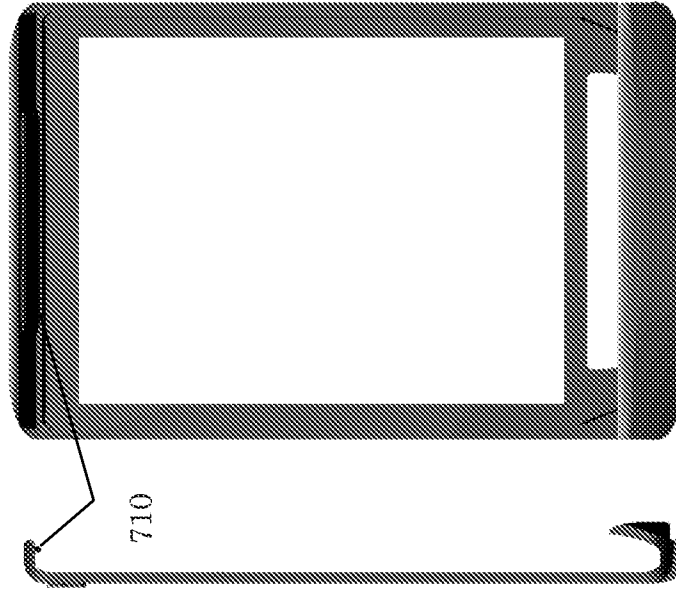
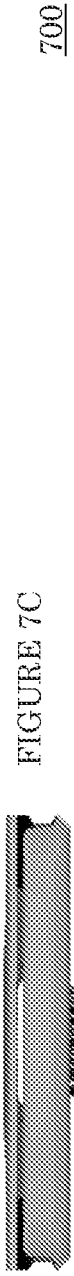

FIGURE 7E

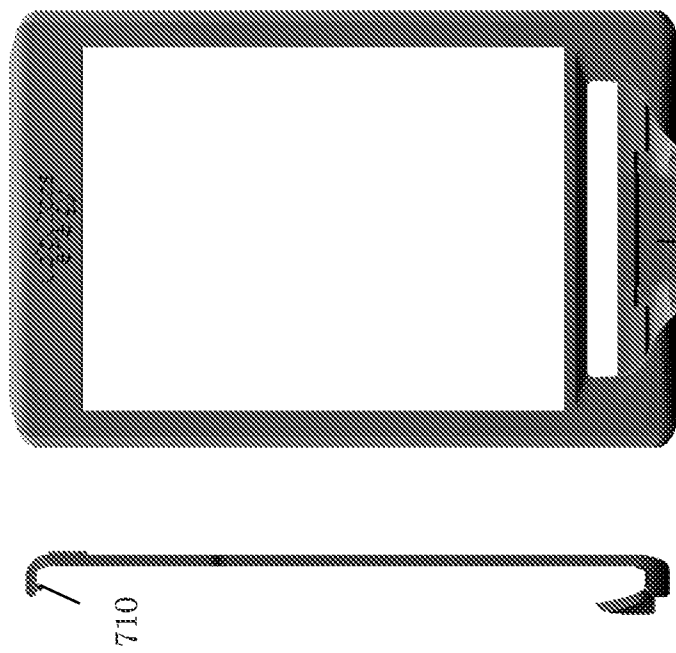

FIGURE 7A

FIGURE 7B



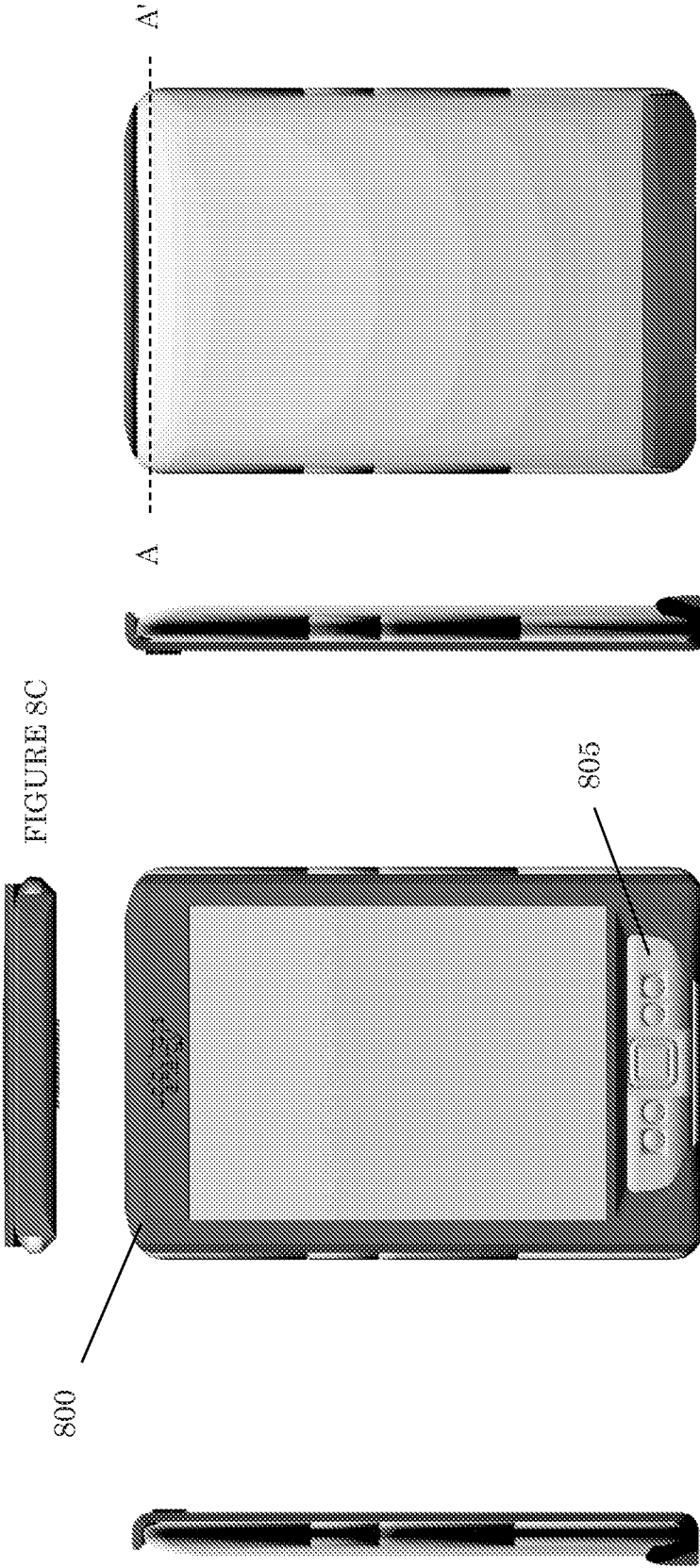

FIGURE 8C

FIGURE 8B

FIGURE 8A

FIGURE 8F

FIGURE 8E

FIGURE 8D

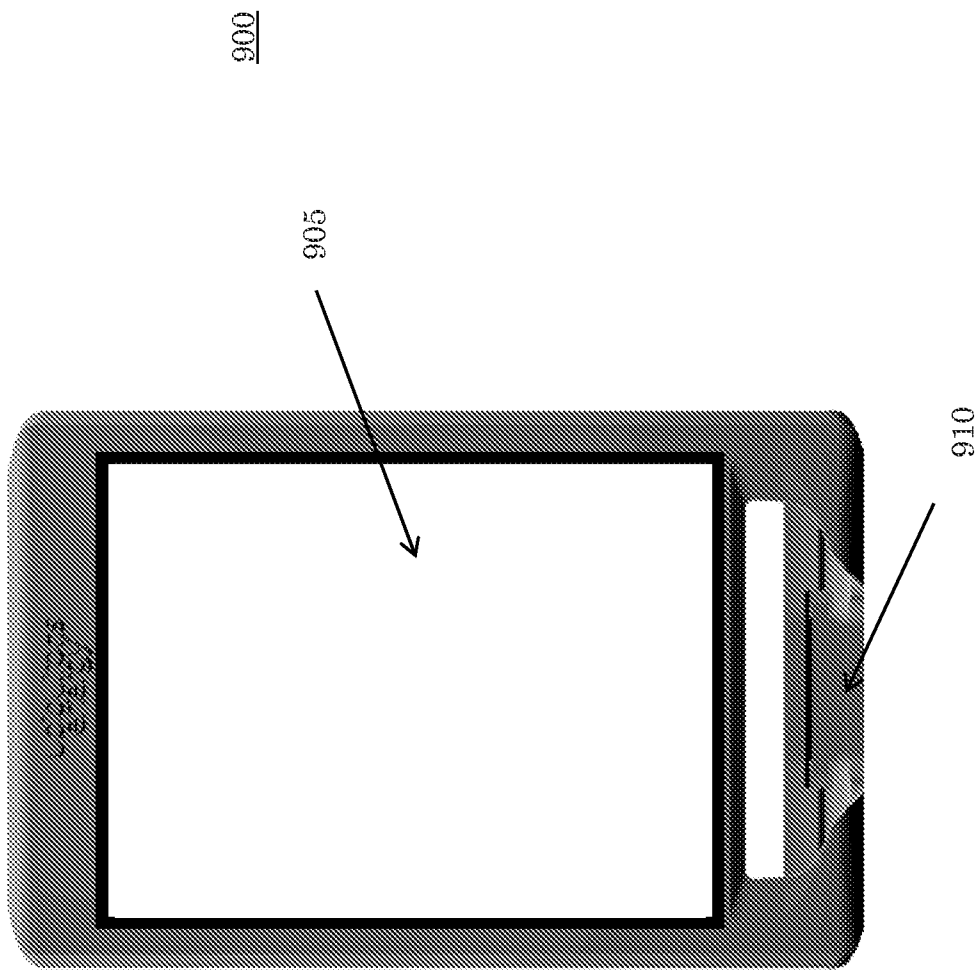

FIGURE 9

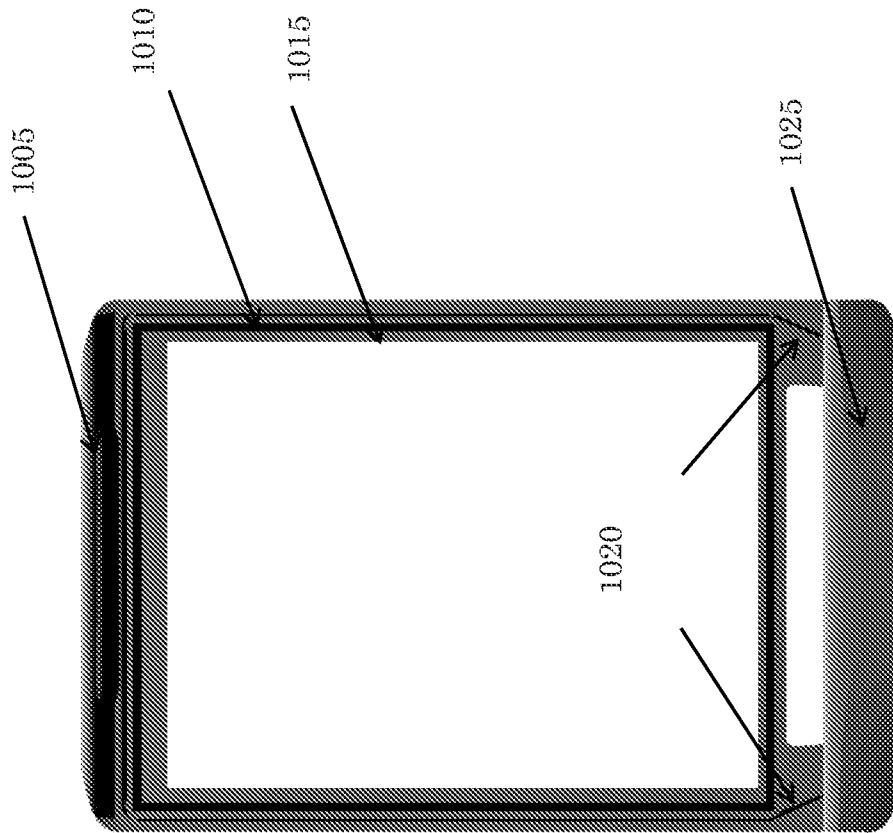

FIGURE 10

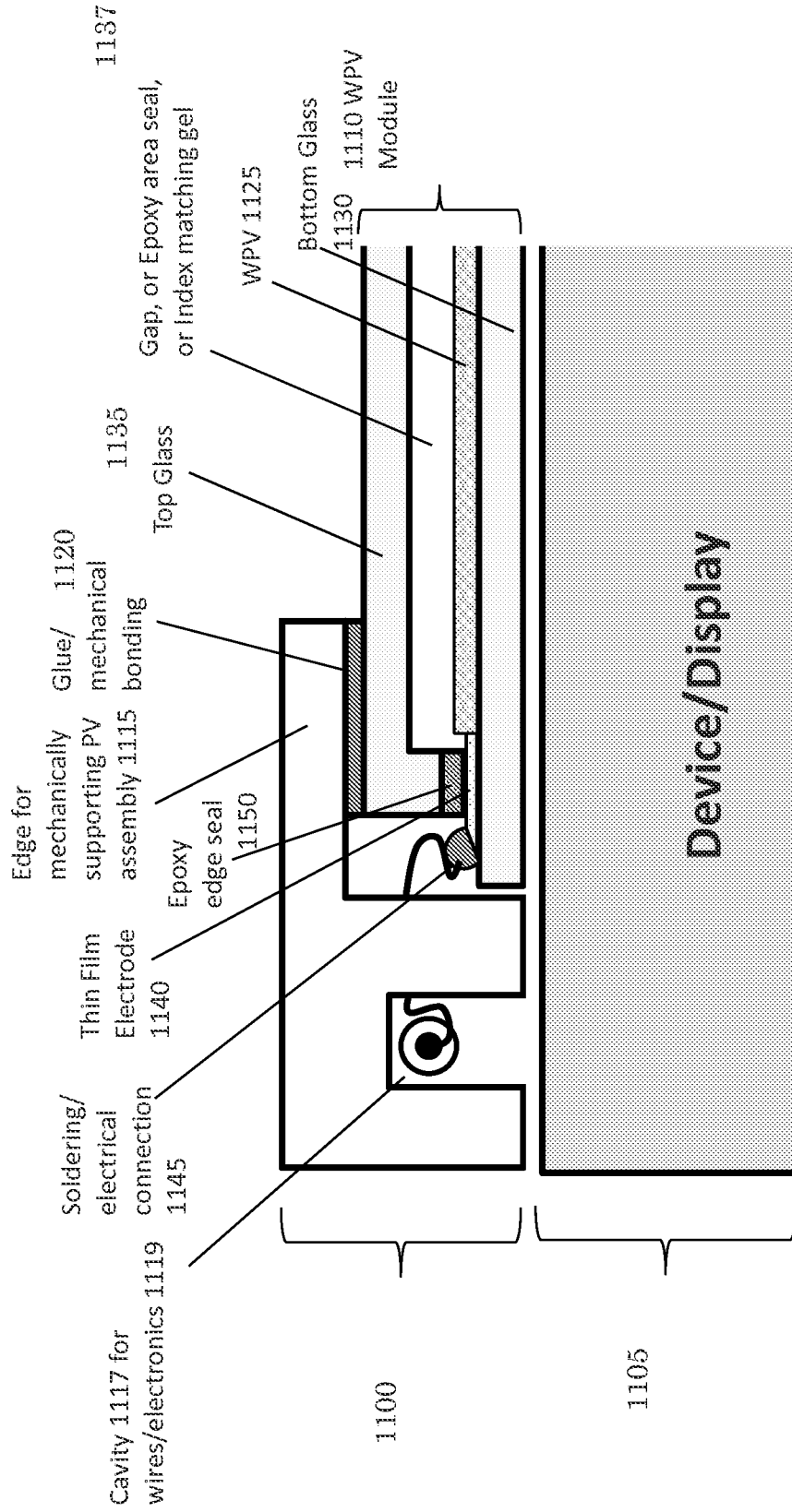

FIGURE 11

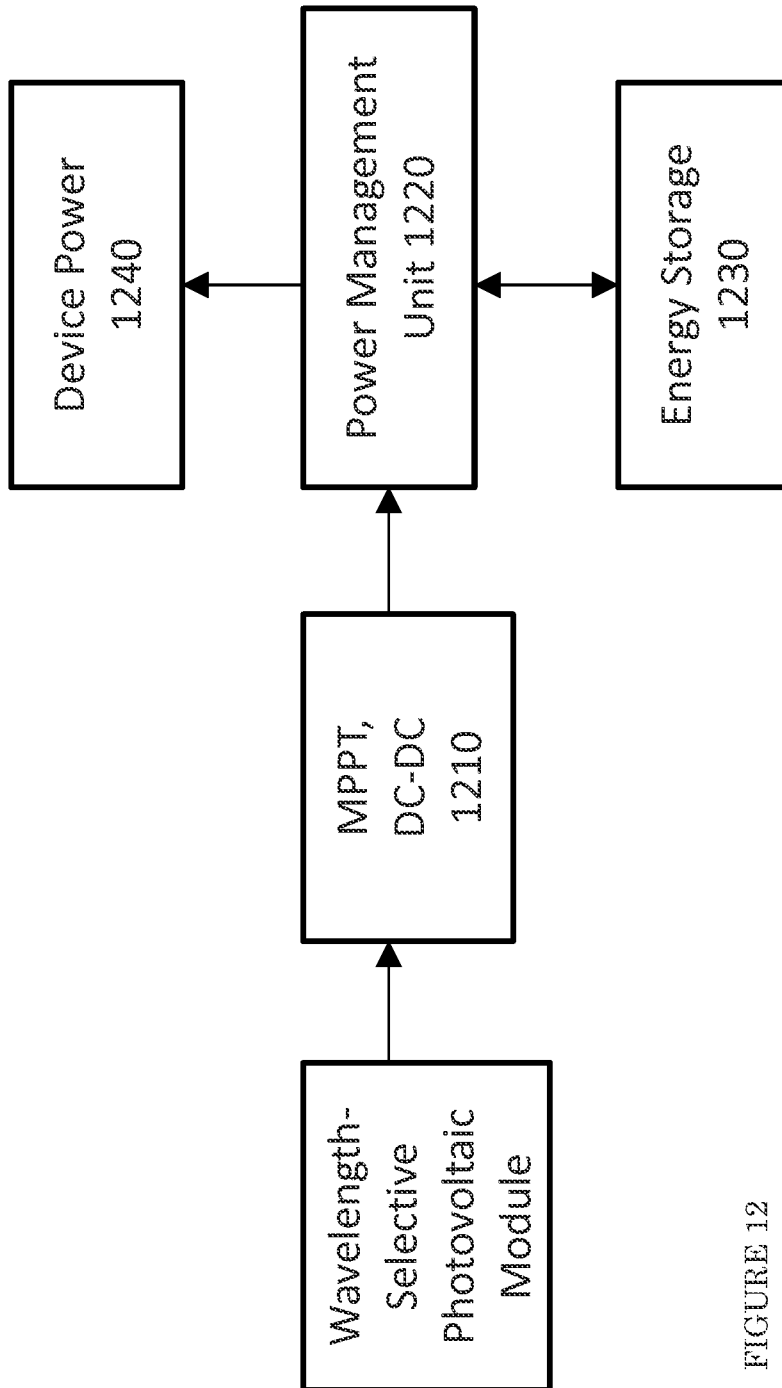

FIGURE 12

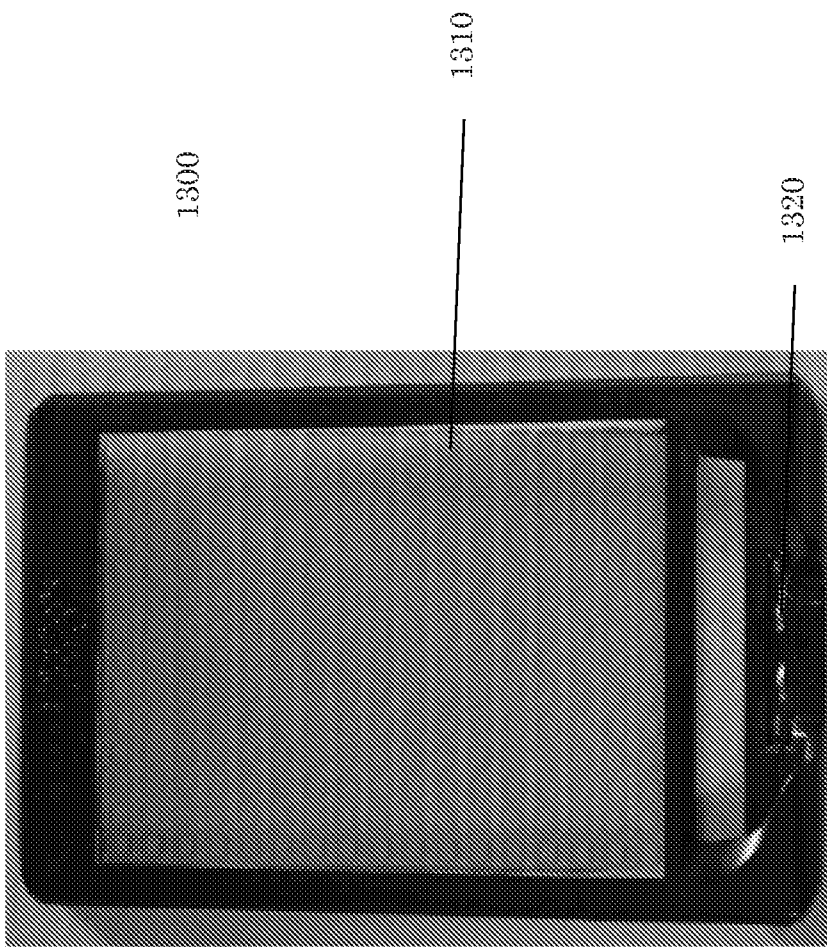

Figure 13

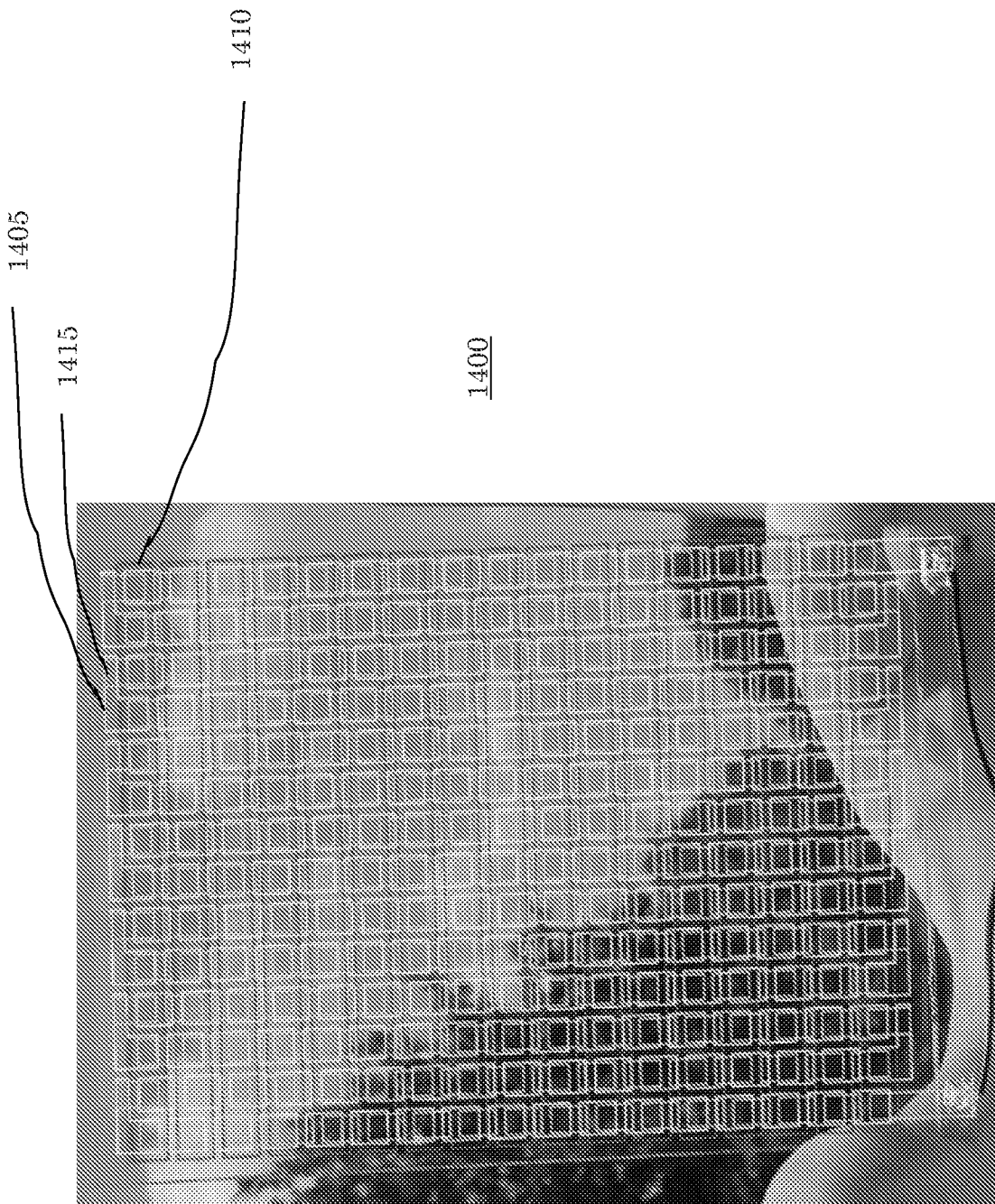

Figure 14

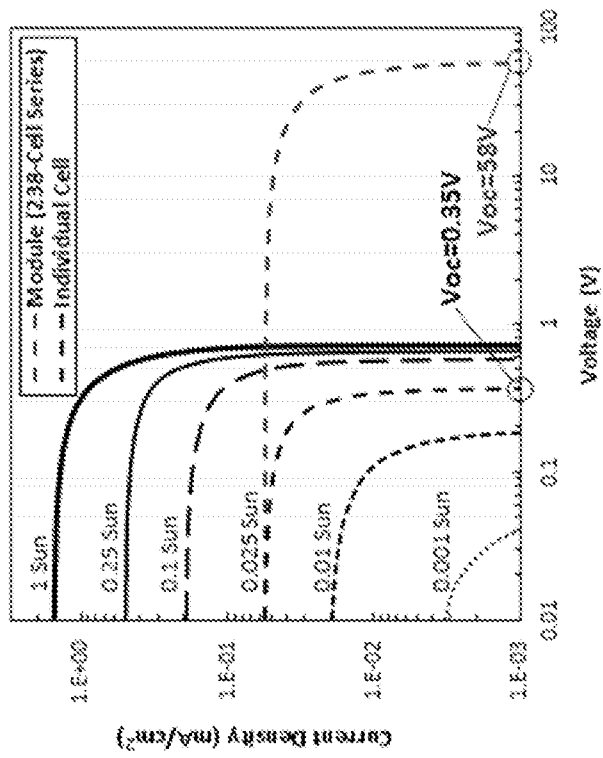

Figure 15

19/24



Figure 16

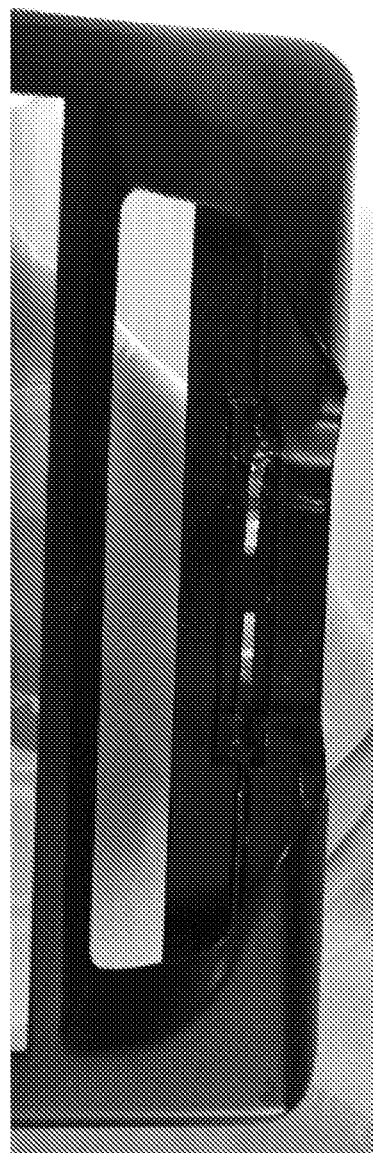

Figure 17

20/24

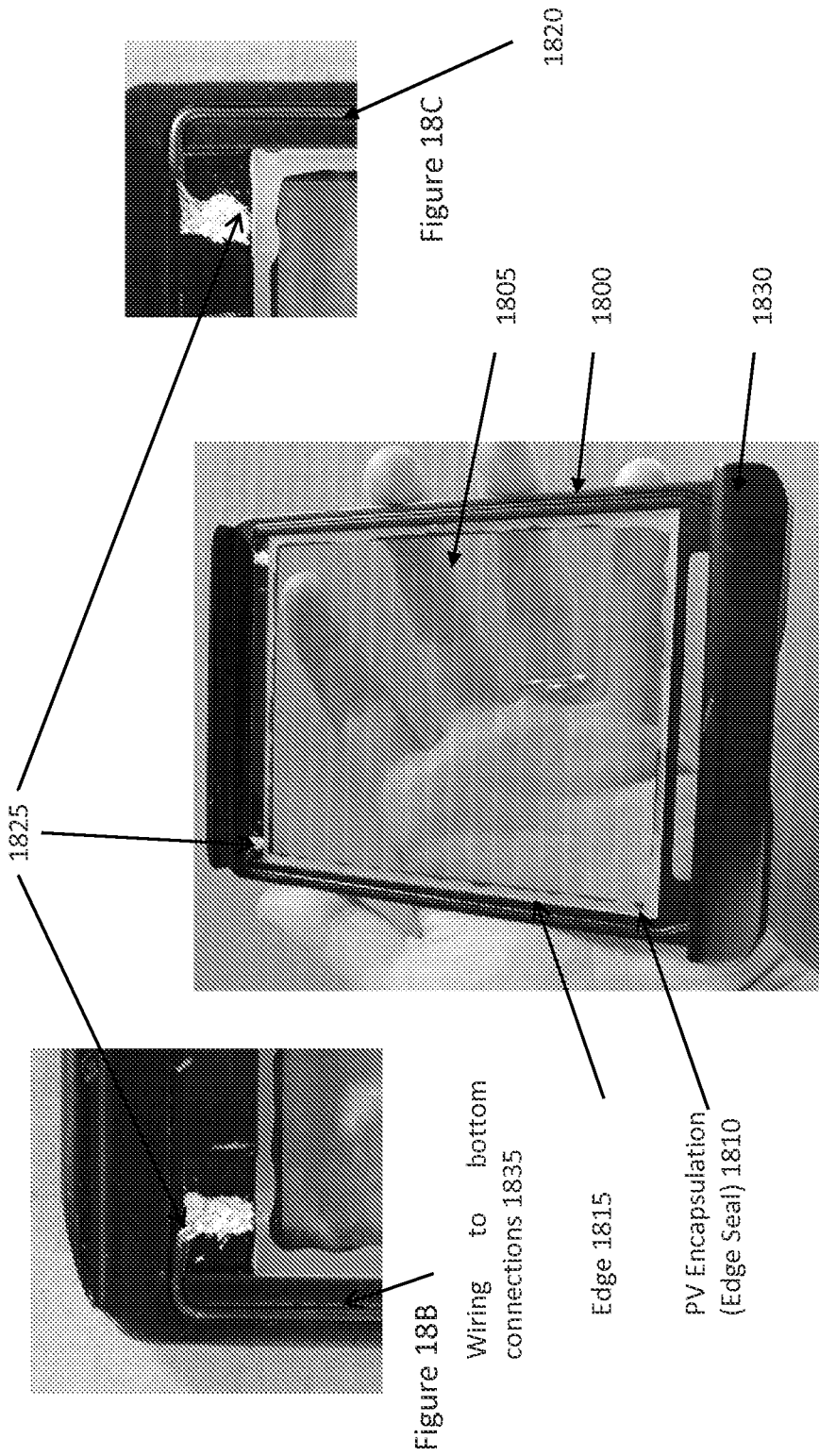

Figure 18A

21/24

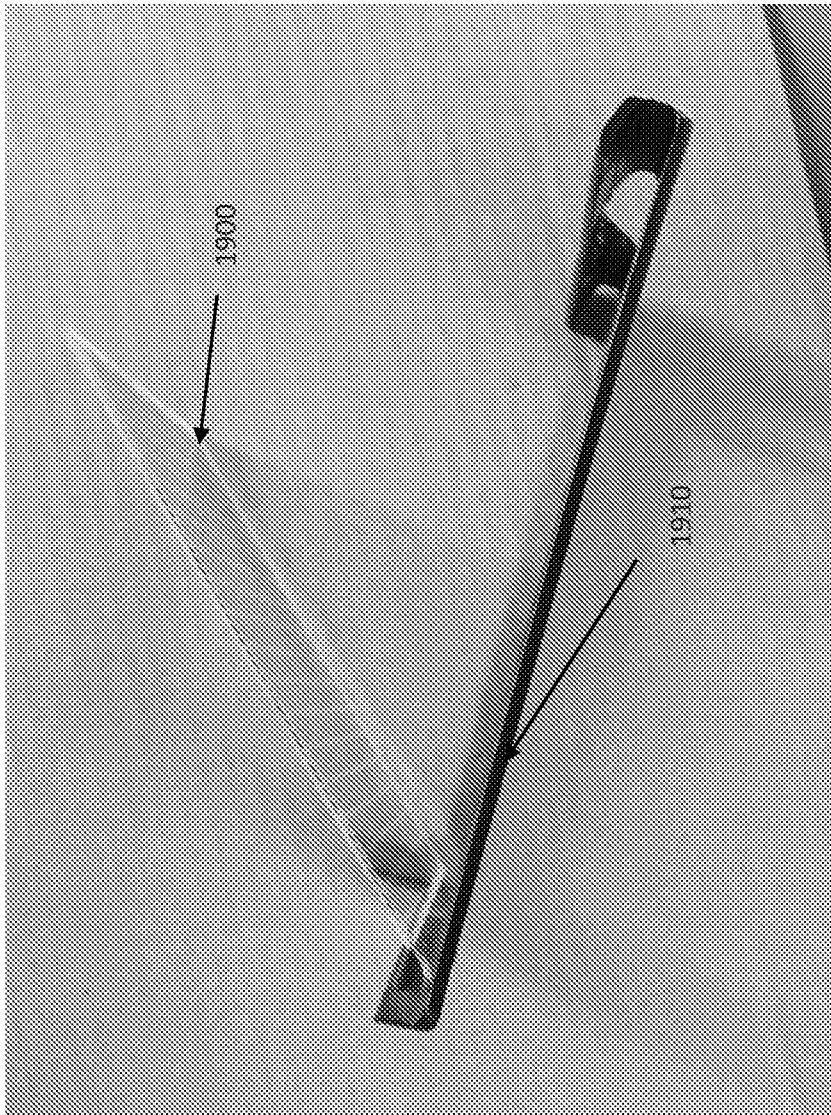

Figure 19A



Figure 19B

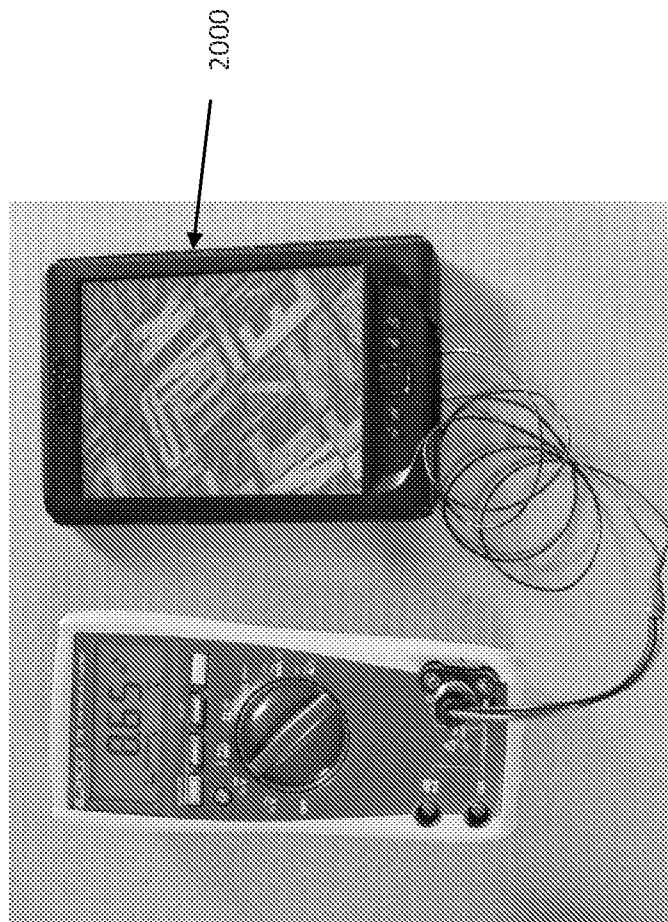

Figure 20

2100

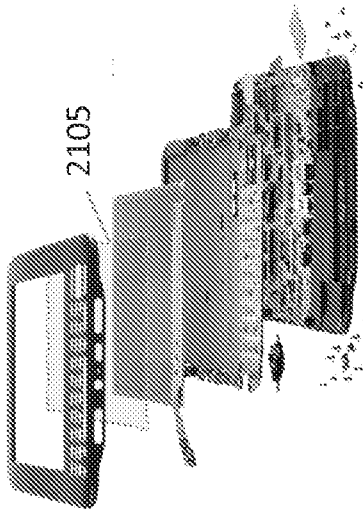
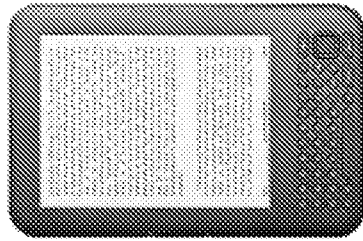

Figure 21B

Figure 21A

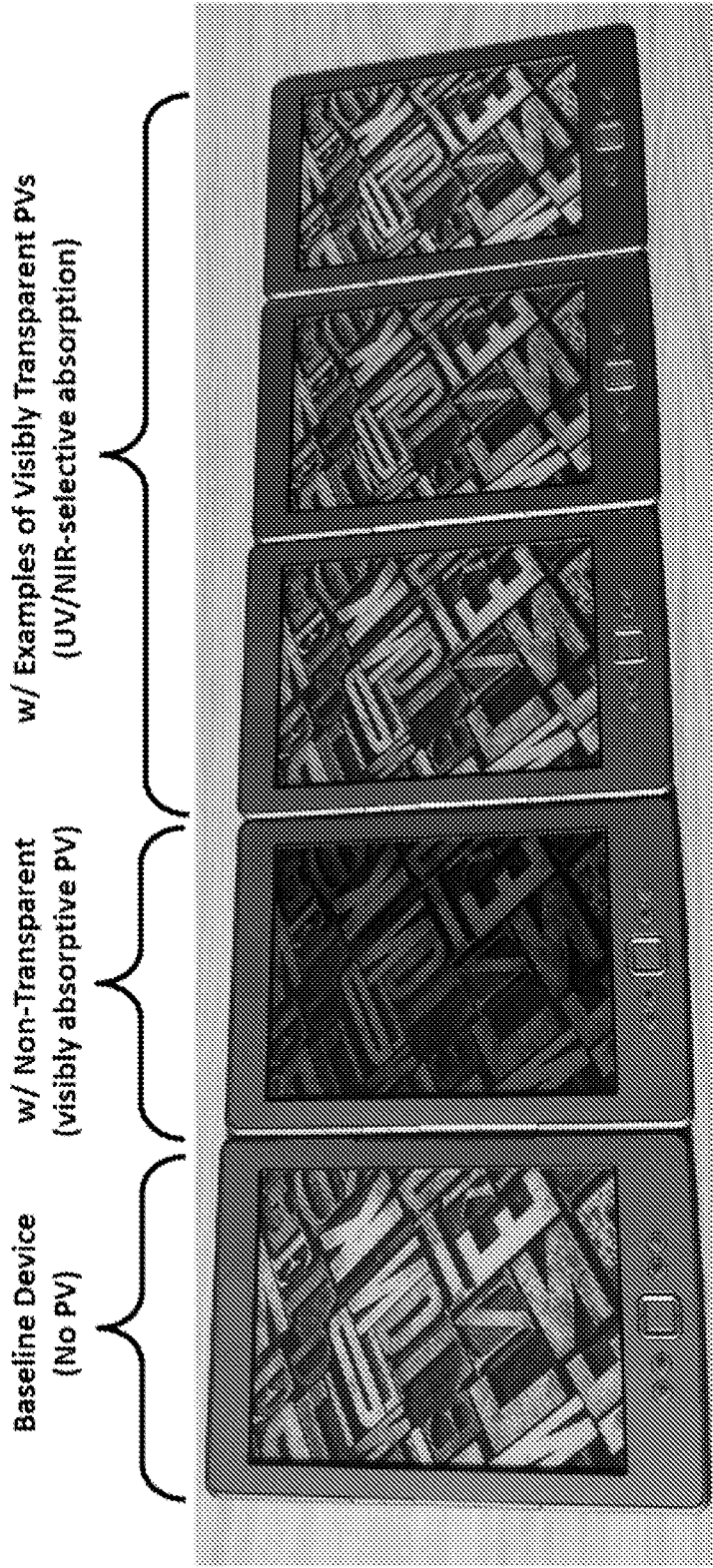

Figure 22A

Figure 22B

Figure 22C

Figure 22D

Figure 22E

FORM 1  
THE PATENTS ACT 1970  
(39 of 1970)  
&  
THE PATENTS (AMENDMENT) RULES, 2006  
APPLICATION FOR GRANT OF PATENT  
(See section 7, 54 & 135 and rule 20 (1))

(FOR OFFICE USE ONLY)

Application No:  
Filing Date:  
Amount of Fee Paid:  
CBR No:  
Signature:

1. APPLICANT

Name	Nationality	Address
Ubiquitous Energy, Inc.	US	3696 Haven Avenue, Suite B, Redwood City, California 94063, U.S.A.

2. INVENTORS

Name	Nationality	Address
BARR, Miles C.	US	3696 Haven Avenue, Suite B, Redwood City, California 94063, U.S.A.
SALVAS, Ryan	US	227 Shawsheen Avenue, Wilmington, Massachusetts 01887, U.S.A.
HOWE, Bart Anson	US	5303 Bonita Avenue, Dallas, Texas 75206, U.S.A.
LUNT, Richard Royal	US	400 Trotters Lane, Williamston, Michigan 48895, U.S.A.
BULOVIC, Vladimir	US	16 Lillian Road, Lexington, Massachusetts 02420, U.S.A.

3. TITLE OF THE INVENTION:

Wavelength-Selective Photovoltaic For A Display Or For A Device With A Display

4. ADDRESS FOR CORRESPONDENCE OF AUTHORIZED PATENT AGENT IN INDIA

LEXORBIS  
709/710, Tolstoy House  
15 – 17, Tolstoy Marg  
New Delhi -110 001

Telephone No. 91 11 2371 6565  
Fax: 91 11 2371 6556  
Mobile No.:  
Email: [mail@lexorbis.com](mailto:mail@lexorbis.com)

5. PRIORITY PARTICULARS OF THE APPLICATION (S) FILED IN CONVENTION COUNTRY

Country	Application Number	Application Filing Date	Name of the Applicant	Title of the Invention
U.S.A.	61/708,389	October 1, 2012	BARR, Miles C.; SALVAS, Ryan	Transparent Photovoltaic Charger For Mobile Devices

6. PARTICULARS FOR FILING PATENT COOPERATION TREATY (PCT) NATIONAL PHASE APPLICATION

International application number	International filing date as allotted by the receiving office
PCT/US2013/062911	October 1, 2013

7. PARTICULARS FOR FILING DIVISIONAL APPLICATION

Original (first) application number	Date of filing of Original (first) application
Not Applicable	Not Applicable

8. PARTICULARS FOR FILING PATENT OF ADDITION

Main application/Patent Number.	Date of filing of main application
Not Applicable	Not Applicable

9. DECLARATIONS:

(i) Declaration by the Inventors

We, the above named inventors are the true & first inventors for this invention and declare that the applicant herein is our assignee.

Date: \_\_\_\_\_

\_\_\_\_\_  
BARR, Miles C.

Date: \_\_\_\_\_

\_\_\_\_\_  
SALVAS, Ryan

Date: \_\_\_\_\_

\_\_\_\_\_  
HOWE, Bart Anson

Date: \_\_\_\_\_

\_\_\_\_\_  
LUNT, Richard Royal

Date: \_\_\_\_\_

\_\_\_\_\_  
BULOVIC, Vladimir

(ii) DECLARATION BY THE APPLICANT IN THE CONVENTION COUNTRY

Not Applicable

(iii) DECLARATION BY THE APPLICANT:

We, the applicant hereby declare that:

- (√) We are in possession of the above- mentioned invention.
- (√) The complete specification relating to the invention is filed with this application.
- (X) The invention as disclosed in the specification uses the biological material from India and the necessary permission from the competent authority shall be submitted by us before the grant of patent to us.
- (√) There is no lawful ground of objection to the grant of the patent to us.
- (√) We are the assignee of true & first inventors.
- (√) The application or each of the applications, particulars of which are given in Para- 5 was the first application in convention country/countries in respect of our invention.
- (√) We claim the priority from the above-mentioned application filed in convention country/countries and state that no application for protection in respect of the invention had been made in a convention country before that date by us or by any person from which we derive the title.
- (√) Our application in India is based on international application under Patent Cooperation Treaty (PCT) as mentioned in Para-6.
- (X)The application is divided out of our application particulars of which are given in para-7 and pray that this application may be treated as deemed to have been filed on \_\_\_\_\_ under Sec. 16 of the Act.
- (X) The said invention is an improvement in or modification of the invention particulars of \_\_\_\_\_, which are given in para-8.

10. FOLLOWING ARE THE ATTACHMENTS WITH THE APPLICATION:

- a) Form 2 - Complete specification in conformation with the International application, No. of pages 23; No. of claims 43;
- b) Drawings in conformation with the international application, No. of Sheet 24;
- c) Statement and Undertaking under Section 8 on Form - 3;
- d) Declaration as to inventorship on Form - 5;
- e) A copy of International Application published with International Search Report under PCT publication no. WO 2014/055549 A3 dated April 10, 2014; and
- f) Official Fee of Rs.74, 400/- via wire transfer dated March 31, 2015

We hereby declare that to the best of our knowledge, information and belief the fact and matters stated herein are correct and we request that a patent may be granted to us for the said invention.

Dated this 31<sup>st</sup> day of March, 2015

Manisha Singh  
Agent for the Applicant [IN/PA -740]  
**LEXORBIS**

To,  
The Controller of Patents,  
The Patent Office  
At New Delhi

FORM 5  
THE PATENTS ACT, 1970  
(39 OF 1970)  
&  
THE PATENTS AMENDMENT RULES, 2006  
DECLARATION AS TO INVENTORSHIP  
[See section 10(6) and rule 13(6)]

1. NAME OF APPLICANT

Ubiquitous Energy, Inc.

Hereby declare that the true and first inventor of the invention disclosed in the complete specification filed in pursuance of our application numbered 2618/DELNP/2015 dated March 31, 2015 are:

2. INVENTORS

- (a) Name : BARR, Miles C.  
(b) Nationality : US  
(c) Address : 3696 Haven Avenue, Suite B, Redwood City, California 94063, U.S.A.
- (a) Name : SALVAS, Ryan  
(b) Nationality : US  
(c) Address : 227 Shawsheen Avenue, Wilmington, Massachusetts 01887, U.S.A.
- (a) Name : HOWE, Bart Anson  
(b) Nationality : US  
(c) Address : 5303 Bonita Avenue, Dallas, Texas 75206, U.S.A.
- (a) Name : LUNT, Richard Royal  
(b) Nationality : US  
(c) Address : 400 Trotters Lane, Williamston, Michigan 48895, U.S.A.
- (a) Name : BULOVIC, Vladimir  
(b) Nationality : US  
(c) Address : 16 Lillian Road, Lexington, Massachusetts 02420, U.S.A.

Dated this 31<sup>st</sup> day of March, 2015

Manisha Singh  
Agent for the Applicant [IN/PA -740]  
**LEXORBIS**

To,  
The Controller of Patents  
The Patent Office  
At New Delhi