



US00D802137S

(12) **United States Design Patent**
Butz

(10) **Patent No.:** **US D802,137 S**

(45) **Date of Patent:** **** Nov. 7, 2017**

(54) **INTERDENTAL CLEANER**

FOREIGN PATENT DOCUMENTS

(71) Applicant: **INTERBROS GMBH**, Schönau (DE)

CN 303535305 * 4/2015
WO WO D087426-001 * 8/2015

(72) Inventor: **Jürgen Butz**, Schönau (DE)

(Continued)

(73) Assignee: **INTERBROS GMBH**, Schönau (DE)

Primary Examiner — Wan Laymon

(74) *Attorney, Agent, or Firm* — McGlew and Tuttle, P.C.

(**) Term: **15 Years**

(21) Appl. No.: **29/576,427**

(57) **CLAIM**

(22) Filed: **Sep. 2, 2016**

The ornamental design for a interdental cleaner, as shown and described.

Related U.S. Application Data

(62) Division of application No. 35/500,137 (U.S. filing date under 35 U.S.C. 384), and having an international filing date of Aug. 11, 2015.

DESCRIPTION

(30) **Foreign Application Priority Data**

Feb. 13, 2015 (EM) 001430102
Feb. 27, 2015 (EM) 001430771

FIG. 1 is a perspective view of my design; FIG. 2 is a front view of the design of FIG. 1; FIG. 3 is a rear view of the design of FIG. 1; FIG. 4 is a top view of the design of FIG. 1; FIG. 5 is a bottom view of the design of FIG. 1; FIG. 6 is a left view of the design of FIG. 1; FIG. 7 is a right view of the design of FIG. 1; FIG. 8 is a perspective view of another design; FIG. 9 is a front view of the design of FIG. 8; FIG. 10 is a rear view of the design of FIG. 8; FIG. 11 is a top view of the design of FIG. 8; FIG. 12 is a bottom view of the design of FIG. 8; FIG. 13 is a left view of the design of FIG. 8; FIG. 14 is a right view of the design of FIG. 8; FIG. 15 is a perspective view of another design; FIG. 16 is a front view of the design of FIG. 15; FIG. 17 is a rear view of the design of FIG. 15; FIG. 18 is a top view of the design of FIG. 15; FIG. 19 is a bottom view of the design of FIG. 15; FIG. 20 is a left view of the design of FIG. 15; and, FIG. 21 is a right view of the design of FIG. 15. The term "GUM" is a registered trademark, which forms a part of the claimed design, and is owned by Sunstar Americas, Inc.

(51) **LOC (10) Cl.** **24-02**

(52) **U.S. Cl.**
USPC **D24/152**; D4/111

(58) **Field of Classification Search**
USPC D24/152, 156, 176, 133, 146-147, 119;
D4/104-107, 109, 111, 128, 136; D28/68
CPC A46B 3/00; A46B 1/00; A46B 5/00; A46B
5/0062; A46B 5/02; A46B 5/021; A46B
5/026; A46B 2200/108; A46B 2200/1066;
A61C 15/00; A61C 15/02; A61C 15/047;
A61C 15/048; A61C 15/0069; A61C
15/0087; A61C 15/0093
See application file for complete search history.

(56) **References Cited**

U.S. PATENT DOCUMENTS

D536,529 S * 2/2007 Antler D4/111
D594,984 S * 6/2009 Crossman D24/152

(Continued)

1 Claim, 21 Drawing Sheets

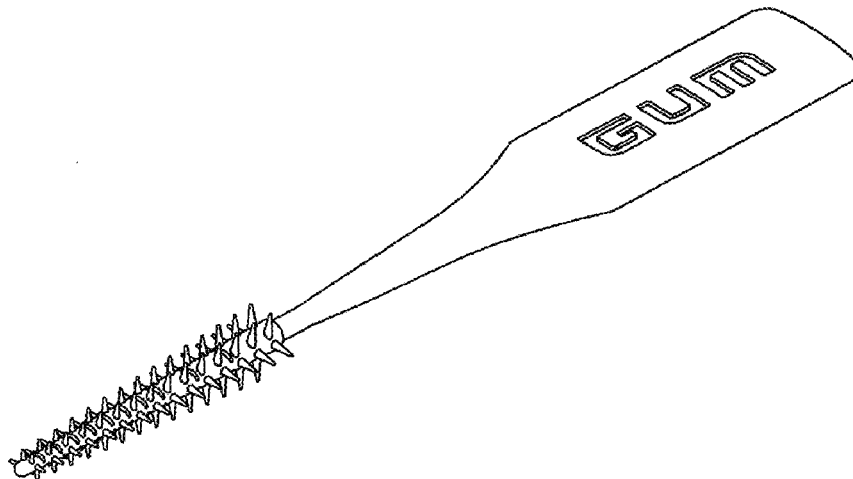

(56)

References Cited

U.S. PATENT DOCUMENTS

D674,610 S * 1/2013 Eatherton D4/111
8,663,520 B2 * 3/2014 Kalbfeld A46B 1/00
264/138
D767,900 S * 10/2016 Kalbfeld D4/111
2006/0254609 A1 * 11/2006 Kuo A46B 5/02
132/321
2009/0230756 A1 * 9/2009 Crossman A46B 5/02
300/21
2014/0008837 A1 * 1/2014 Eatherton A46B 1/00
264/243
2014/0166043 A1 * 6/2014 Dishon A61C 15/02
132/329
2015/0257861 A1 * 9/2015 Dishon A61C 15/02
132/329
2015/0282601 A1 * 10/2015 Butz A46B 1/00
15/167.1
2016/0058531 A1 * 3/2016 Adriano A61C 15/02
132/329
2016/0135932 A1 * 5/2016 Butz A61C 15/02
132/329
2016/0367345 A1 * 12/2016 Wallstrom A61C 15/02

FOREIGN PATENT DOCUMENTS

WO WO D087426-009 * 8/2015
WO WO D087426-010 * 8/2015
WO WO D087426-011 * 8/2015
WO WO D087426-012 * 8/2015

* cited by examiner

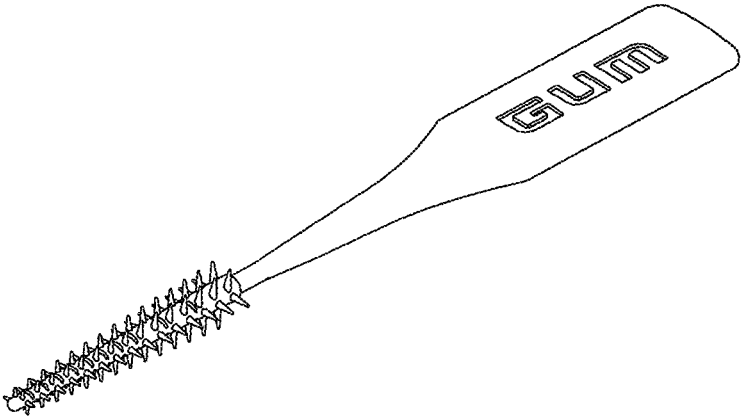

Fig. 1

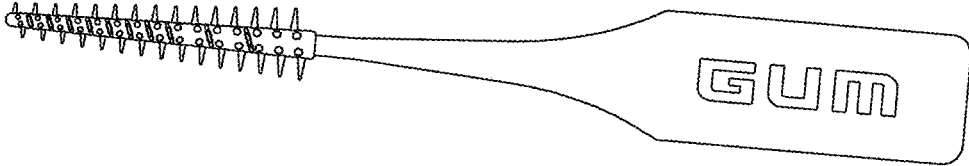

Fig. 2

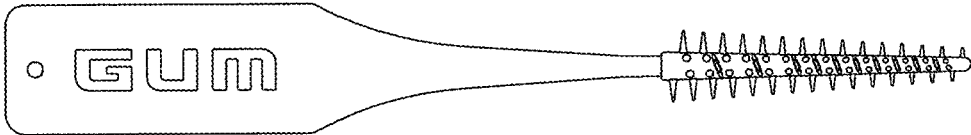

Fig. 3



Fig. 4



Fig. 5

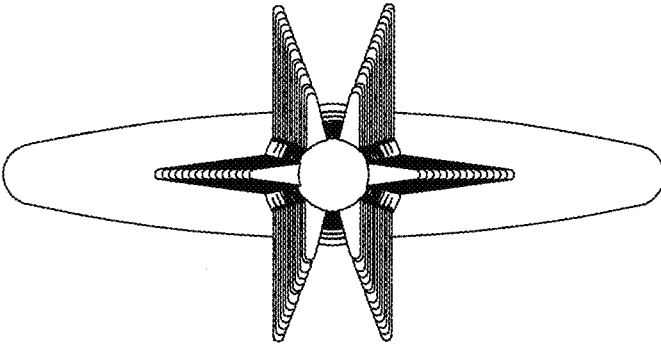

Fig. 6

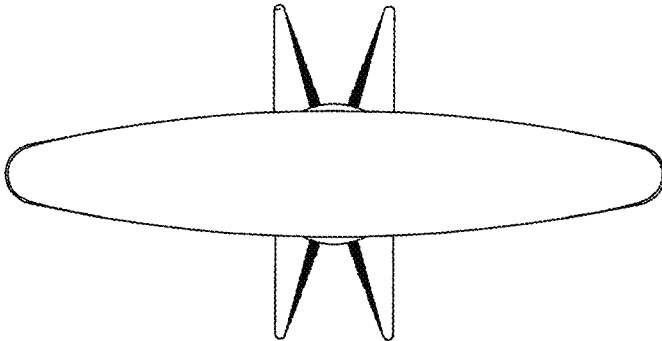

Fig. 7

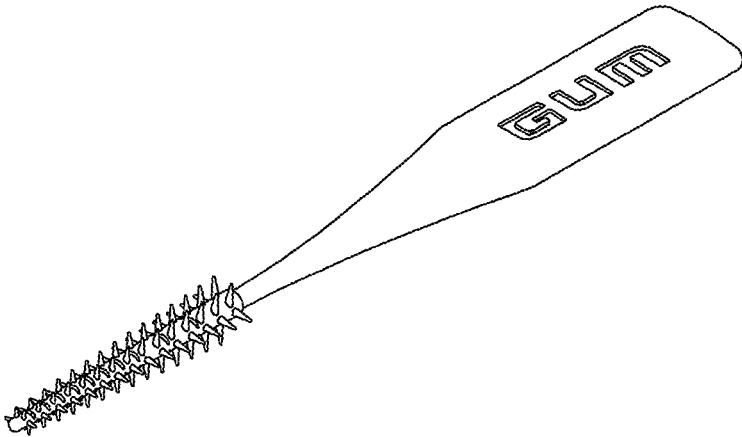

Fig. 8

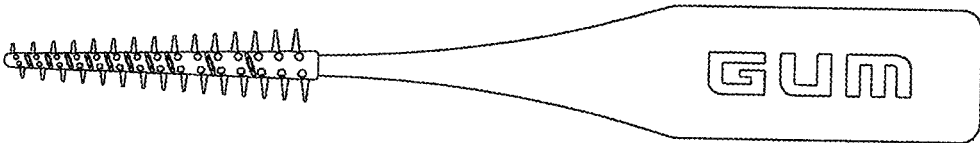

Fig. 9

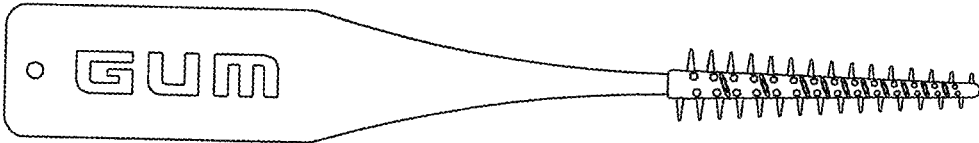

Fig. 10



Fig. 11



Fig. 12

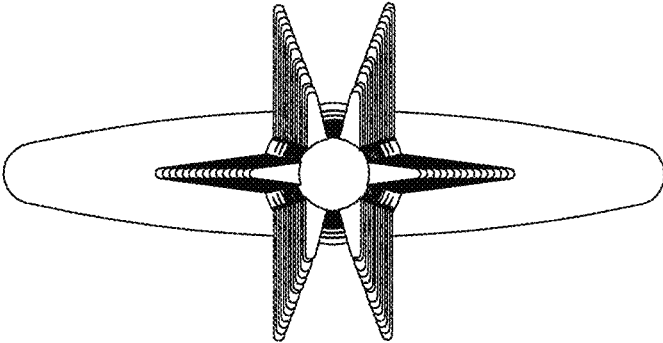

Fig. 13

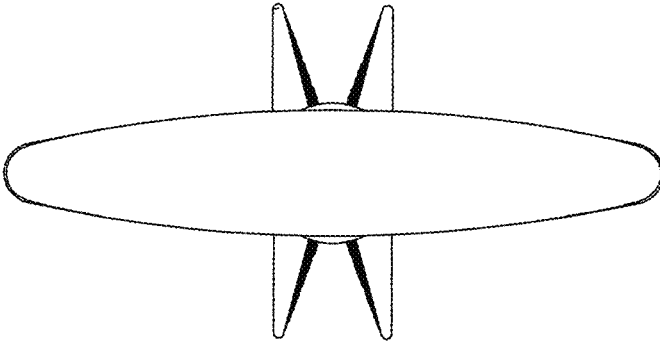

Fig. 14

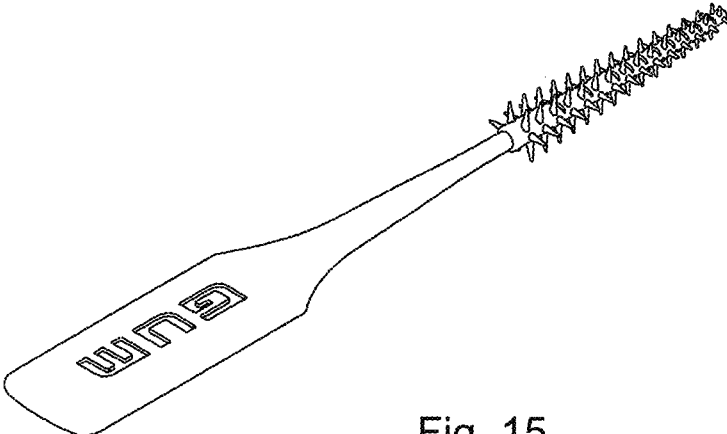

Fig. 15

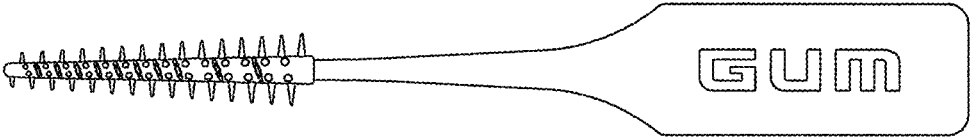

Fig. 16

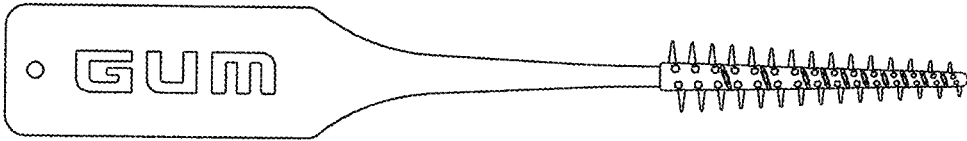

Fig. 17



Fig. 18

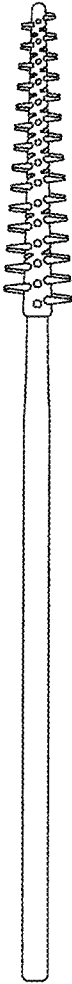

Fig. 19

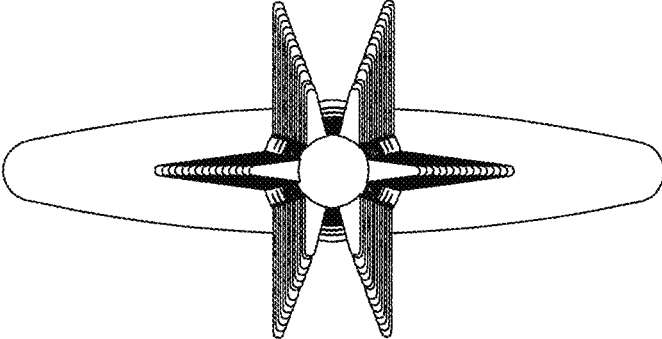

Fig. 20

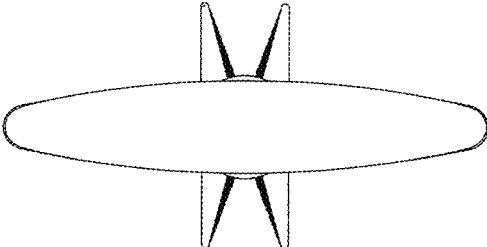

Fig. 21