



(12) **EUROPEAN PATENT APPLICATION**

(43) Date of publication:  
**24.09.2008 Bulletin 2008/39**

(51) Int Cl.:  
**H01Q 9/04** (2006.01) **H01Q 1/38** (2006.01)  
**H01Q 5/00** (2006.01) **H01Q 1/24** (2006.01)

(21) Application number: **07104442.4**

(22) Date of filing: **19.03.2007**

(84) Designated Contracting States:  
**AT BE BG CH CY CZ DE DK EE ES FI FR GB GR HU IE IS IT LI LT LU LV MC MT NL PL PT RO SE SI SK TR**  
 Designated Extension States:  
**AL BA HR MK RS**

- **Wen, Geyi**  
**Waterloo Ontario N2T 2V1 (CA)**
- **Pecen, Mark**  
**Waterloo Ontario N2L 5P3 (CA)**

(71) Applicant: **Research In Motion Limited**  
**Waterloo, Ontario N2L 3W8 (CA)**

(74) Representative: **Rickard, David John**  
**26 Mallinson Road**  
**London SW11 1BP (GB)**

(72) Inventors:  
 • **Rao, Qinjiang**  
**Waterloo Ontario N2L 4X6 (CA)**

Remarks:  
 Amended claims in accordance with Rule 137(2) EPC.

(54) **Multi-band slot-strip antenna**

(57) A multi-band antenna (300) includes a planar conductive layer (302) that comprises a conductive region (308) and a non-conductive region. The conductive region and the non-conductive region together define a first slot-strip structure (312), a second slot-strip structure (314) coupled to the first slot-strip structure, and a third

slot-strip structure (316) coupled to the second slot-strip structure. The first slot-strip structure includes a signal feed portion (304). The second slot-strip structure includes a first signal grounding portion (306a). The third slot-strip structure includes a second signal grounding portion (306b).

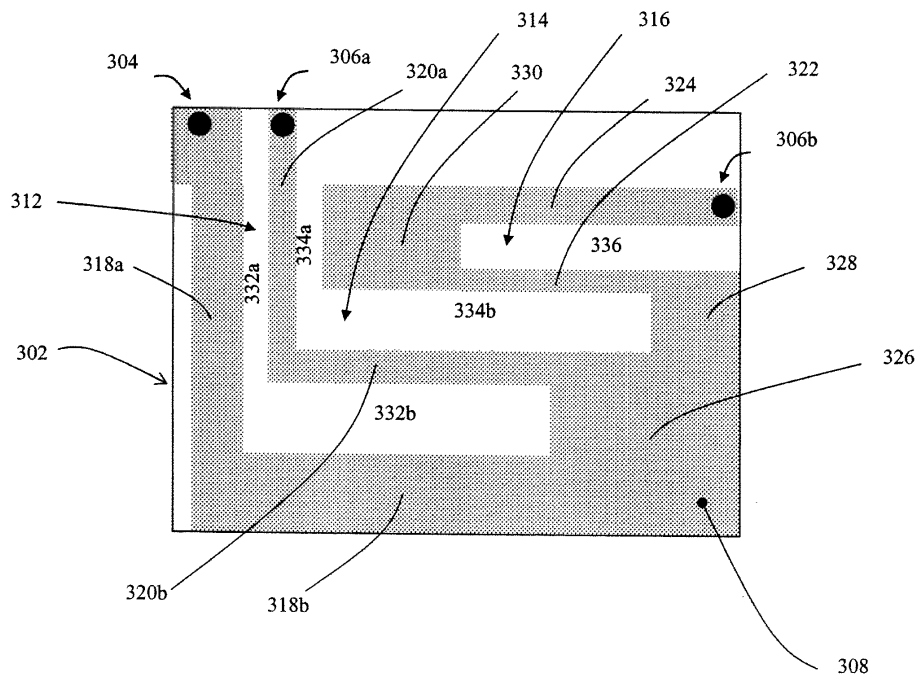

300

**FIG. 3**

## Description

**[0001]** The invention described herein relates generally to a multi-band antenna for a handheld wireless communications device. In particular, the invention relates to a multi-band slot-strip antenna.

**[0002]** Slot antennas typically comprise a slot cut into a metal sheet or printed circuit board. Since some modern communication devices are required to operate in multiple frequency bands, multi-band slot antennas have been developed for use in such devices.

**[0003]** For instance, Chang (US 7,006,048) describes a dual-band slot antenna for satellite and/or RFID communication systems. The slot antenna comprises two interconnected L-shaped slot antenna structures, and a printed circuit feed line that is coupled to both of the L-shaped slot antenna structures. Sun (US 6,677,909) describes dual-band slot antenna that comprises a pair of meandering slots, and a coaxial feed cable that is connected to the meandering slots.

**[0004]** Planar inverted-F antennas (PIFA) are becoming increasingly common in wireless handheld communication devices due to their reduced size in comparison to conventional microstrip antenna designs. Therefore, PIFA antennas have been developed which include multiple resonant sections, each having a respective resonant frequency. However, since conventional PIFA antennas have a very limited bandwidth, broadband technologies, such as parasitic elements and/or multi-layer structures, have been used to modify the conventional PIFA antenna for multi-band and broadband applications.

**[0005]** These approaches increase the size of the antenna, making the resulting designs unattractive for modern handheld communication devices. Also, the additional resonant branches introduced by these approaches make the operational frequencies of the antennas difficult to tune. Further, the additional branches can introduce significant electromagnetic compatibility (EMC) and electromagnetic interference (EMI) problems.

## GENERAL

**[0006]** According to the invention described herein, a multi-band antenna may comprise at least three slot-strip structures configured with multiple ground pins.

**[0007]** In accordance with a first aspect of the invention, there may be provided a multi-band slot-strip antenna that comprises a planar conductive layer comprising a conductive region and a non-conductive region. The conductive region and the non-conductive region together may define a first slot-strip structure, a second slot-strip structure coupled to the first slot-strip structure, and a third slot-strip structure coupled to the second slot-strip structure. The first slot-strip structure may comprise a signal feed portion. The second slot-strip structure may include a first signal grounding portion. The third slot-strip structure comprises a second signal grounding por-

tion.

**[0008]** In accordance with a second aspect of the invention, there may be provided a wireless communication device that comprises a radio transceiver section, and a multi-band slot-strip antenna coupled to the radio transceiver section. The multi-band slot-strip antenna may comprise a planar conductive layer comprising a conductive region and a non-conductive region. The conductive region and the non-conductive region together may define a first slot-strip structure, a second slot-strip structure coupled to the first slot-strip structure, and a third slot-strip structure coupled to the second slot-strip structure. The first slot-strip structure may comprise a signal feed portion. The second slot-strip structure may include a first signal grounding portion. The third slot-strip structure may comprise a second signal grounding portion. The signal feed portion may be coupled to the radio transceiver section.

**[0009]** In accordance with a third aspect of the invention, there may be provided a multi-band slot-strip antenna that comprises a planar conductive layer comprising a conductive region and a non-conductive region. The conductive region and the non-conductive region together may define a plurality of mutually-coupled slot-strip structures. The slot-strip antenna also may comprise a feed signal pin connected to one of the slot-strip structures, and a ground pin connected to the other slot-strip structures.

**[0010]** As will become apparent, in addition to a higher frequency band around 5 GHz for WLAN 802.11 j/a applications, the multi-band antenna offers enhanced low frequency bandwidth around 2 GHz for 3G communications, from a structure whose size is suitable for incorporation into small handheld communications devices.

## BRIEF DESCRIPTION OF THE DRAWINGS

**[0011]** The invention will now be described, by way of example only, with reference to the accompanying drawings, in which:

Fig. 1 is a front plan view of a handheld communications device according to the invention;

Fig. 2 is a schematic diagram depicting certain functional details of the handheld communications device;

Fig. 3 is a top plan view of a multi-band slot-strip antenna of the handheld communications device, suitable for use with a wireless network;

Fig. 4 to 6 are computer simulations of the return loss for the multi-band slot-strip antenna;

Fig. 7 is a computer simulation of the return loss for a preferred implementation of the multi-band slot-strip antenna; and

Fig. 8 depicts the computer simulated and actual return loss for the preferred implementation of the multi-band slot-strip antenna.

## DESCRIPTION OF PREFERRED EMBODIMENTS

**[0012]** Turning to Fig. 1, there is shown a sample handheld communications device 200 in accordance with the invention. Preferably, the handheld communications device 200 is a two-way wireless communications device having at least voice and data communication capabilities, and is configured to operate within a wireless cellular network. Depending on the exact functionality provided, the wireless handheld communications device 200 may be referred to as a data messaging device, a two-way pager, a wireless e-mail device, a cellular telephone with data messaging capabilities, a wireless Internet appliance, or a data communication device, as examples.

**[0013]** As shown, the handheld communications device 200 includes a display 222, a function key 246, and data processing means (not shown) disposed within a common housing 201. The display 222 comprises a backlit LCD display. The data processing means is in communication with the display 222 and the function key 246. In one implementation, the backlit display 222 comprises a transmissive LCD display, and the function key 246 operates as a power on/off switch. Alternately, in another implementation, the backlit display 222 comprises a reflective or trans-reflective LCD display, and the function key 246 operates as a backlight switch.

**[0014]** In addition to the display 222 and the function key 246, the handheld communications device 200 includes user data input means for inputting data to the data processing means. As shown, preferably the user data input means includes a keyboard 232, a thumbwheel 248 and an escape key 260. The keyboard 232 includes alphabetic and numerical keys, and preferably also includes a "Send" key and an "End" key to respectively initiate and terminate voice communication. However, the data input means is not limited to these forms of data input. For instance, the data input means may include a trackball or other pointing device instead of (or in addition to) the thumbwheel 248.

**[0015]** Fig. 2 depicts functional details of the handheld communications device 200. As shown, the handheld communications device 200 incorporates a motherboard that includes a communication subsystem 211, and a microprocessor 238. The communication subsystem 211 performs communication functions, such as data and voice communications, and includes a primary transmitter/receiver 212, a secondary transmitter/receiver 214, a primary internal antenna 216 for the primary transmitter/receiver 212, a secondary internal antenna 300 for the secondary transmitter/receiver 214, and local oscillators (LOs) 213 and one or more digital signal processors (DSP) 220 coupled to the transmitter/receivers 212, 214.

**[0016]** Typically, the communication subsystem 211 sends and receives wireless communication signals over a wireless cellular network via the primary transmitter/receiver 212 and the primary internal antenna 216. Further, typically the communication subsystem 211 sends and receives wireless communication signals over a local

area wireless network via the secondary transmitter/receiver 214 and the secondary internal antenna 300.

**[0017]** Preferably, the primary internal antenna 216 is configured for use within a Global System for Mobile Communications (GSM) cellular network or a Code Division Multiple Access (CDMA) cellular network. Further, preferably the secondary internal antenna 300 is configured for use within a Universal Mobile Telecommunications Service (UMTS) or WLAN WiFi (IEEE 802.11x) network. More preferably, the secondary internal antenna 300 is a multi-band slot-strip antenna that is configured for use with networks whose operational frequencies are at/near 2GHz and 5 GHz, and whose low frequency bandwidth is suitable for 3G communications and high frequency band for WLAN 802.11 j/a applications. Although the handheld communications device 200 is depicted in Fig. 2 with two antennas, it should be understood that the handheld communications device 200 may instead comprise only a single antenna, with the multi-band slot-strip antenna 300 being connected to both the primary transmitter/receiver 212 and the secondary transmitter/receiver 214. Further, although Fig. 2 depicts the multi-band antenna 300 incorporated into the handheld communications device 200, the multi-band antenna 300 is not limited to mobile applications, but may instead be used with a stationary communications device. The preferred structure of the multi-band antenna 300 will be discussed in detail below, with reference to Figs. 3 to 8.

**[0018]** Signals received by the primary internal antenna 216 from the wireless cellular network are input to the receiver section of the primary transmitter/receiver 212, which performs common receiver functions such as frequency down conversion, and analog to digital (A/D) conversion, in preparation for more complex communication functions performed by the DSP 220. Signals to be transmitted over the wireless cellular network are processed by the DSP 220 and input to transmitter section of the primary transmitter/receiver 212 for digital to analog conversion, frequency up conversion, and transmission over the wireless cellular network via the primary internal antenna 216.

**[0019]** Similarly, signals received by the secondary internal antenna 300 from the local area wireless network are input to the receiver section of the secondary transmitter/receiver 214, which performs common receiver functions such as frequency down conversion, and analog to digital (A/D) conversion, in preparation for more complex communication functions performed by the DSP 220. Signals to be transmitted over the local area wireless network are processed by the DSP 220 and input to transmitter section of the secondary transmitter/receiver 214 for digital to analog conversion, frequency up conversion, and transmission over the local area wireless network via the secondary internal antenna 300. If the communication subsystem 211 includes more than one DSP 220, the signals transmitted and received by the secondary transmitter/receiver 214 would preferably be processed by a different DSP than the primary transmitter/receiver

212.

**[0020]** The communications device 200 also includes a SIM interface 244 if the handheld communications device 200 is configured for use within a GSM network, and/or a RUIM interface 244 if the handheld communications device 200 is configured for use within a CDMA network. The SIM/RUIM interface 244 is similar to a card-slot into which a SIM/RUIM card can be inserted and ejected like a diskette or PCMCIA card. The SIM/RUIM card holds many key configurations 251, and other information 253 including subscriber identification information, such as the International Mobile Subscriber Identity (IMSI) that is associated with the handheld communications device 200, and subscriber-related information.

**[0021]** The microprocessor 238, in conjunction with the flash memory 224 and the RAM 226, comprises the aforementioned data processing means and controls the overall operation of the device. The data processing means interacts with device subsystems such as the display 222, flash memory 224, RAM 226, auxiliary input/output (I/O) subsystems 228, data port 230, keyboard 232, speaker 234, microphone 236, short-range communications subsystem 240, and device subsystems 242. The data port 230 may comprise a RS-232 port, a Universal Serial Bus (USB) port or other wired data communication port.

**[0022]** As shown, the flash memory 224 includes both computer program storage 258 and program data storage 250, 252, 254 and 256. Computer processing instructions are preferably also stored in the flash memory 224 or other similar non-volatile storage. Other computer processing instructions may also be loaded into a volatile memory such as RAM 226. The computer processing instructions, when accessed from the memory 224, 226 and executed by the microprocessor 238 define an operating system, computer programs, operating system specific applications. The computer processing instructions may be installed onto the handheld communications device 200 upon manufacture, or may be loaded through the cellular wireless network, the auxiliary I/O subsystem 228, the data port 230, the short-range communications subsystem 240, or the device subsystem 242.

**[0023]** The operating system allows the handheld communications device 200 to operate the display 222, the auxiliary input/output (I/O) subsystems 228, data port 230, keyboard 232, speaker 234, microphone 236, short-range communications subsystem 240, and device subsystems 242. Typically, the computer programs include communication software that configures the handheld communications device 200 to receive one or more communication services. For instance, preferably the communication software includes internet browser software, e-mail software and telephone software that respectively allow the handheld communications device 200 to communicate with various computer servers over the internet, send and receive e-mail, and initiate and receive telephone calls.

**[0024]** Fig. 3 depicts the preferred structure for the mul-

ti-band slot-strip antenna 300. The secondary antenna 300 comprises a planar conductive layer 302. Preferably, the planar conductive layer 302 is disposed on a substrate layer (not shown). As shown, the conductive layer 302 has a substantially rectangular shape having two opposing pairs of substantially parallel edges. Preferably, the multi-band slot-strip antenna 300 is implemented as a printed circuit board, with the planar conductive layer 302 comprising copper or other suitable conductive metal.

**[0025]** The conductive layer 302 comprises a conductive region 308 and three non-conductive regions (discussed below). In contrast to the conductive region 308, the non-conductive region is devoid of conductive metal. Typically, the non-conductive region is implemented via suitable printed circuit board etching techniques. As shown, the non-conductive regions, together with the surrounding conductive region 308, define a first slot-strip structure 312, a second slot-strip structure 314 that is electrically coupled to the first slot-strip structure 312, and a third slot-strip structure 316 that is electrically coupled to the second slot-strip structure 314.

**[0026]** The conductive-region 308 comprises a first L-shaped arm 318 (comprising a first linear (straight) minor arm portion 318a and a first linear (straight) major arm portion 318b); a second L-shaped arm 320 (comprising a second linear (straight) minor arm portion 320a and a second linear (straight) major arm portion 320b); a first linear (straight) arm 322 and a second linear (straight) arm 324. The conductive-region 308 also comprises a first rectangular base portion 326 that extends substantially perpendicularly between the first major arm portion 318 and the second major arm portion 320b of the L-shaped arms 318, 320; a second rectangular base portion 328 that extends substantially perpendicularly between the second major arm portion 320b and the first linear arm 322; and a third rectangular base portion 330 that extends substantially perpendicularly between the first and second linear arms 322, 324.

**[0027]** The non-conductive region comprises a first non-conductive slot 332 (comprising first minor slot portion 332a and first major slot portion 332b), a second non-conductive slot 334 (comprising second minor slot portion 334a and second major slot portion 334b), and a third non-conductive slot 336.

**[0028]** The first non-conductive slot 332 has a substantially L-shape, and extends between the first and second L-shaped arms 318, 320, terminating at the first base portion 326. The second non-conductive slot 334 also has a substantially L-shape, and extends between the second L-shaped arm 320, the third base portion 330 and the first linear arm 322, terminating at the second base portion 332. The third non-conductive slot 336 has a substantially linear (straight) shape, and extends between the first and second linear arms 322, 324, terminating at the third base portion 330.

**[0029]** The first slot-strip structure 312 comprises the first L-shaped arm 318, the first base portion 326, the

second base portion 328 and the first non-conductive slot 332. The second slot-strip structure 314 comprises the second L-shaped arm 320, the second base portion 328, the first linear arm 322, and the second non-conductive slot 334. The third slot-strip structure 316 comprises the first linear arm 322, the third base portion 330, the second linear arm 324, and the third non-conductive slot 336.

**[0030]** With this configuration, the first and second slot-strip structures 312, 314 are commonly coupled by the second L-shaped arm 320. Also, the second and third slot-strip structures 314, 316 are commonly coupled by the first linear arm 322. Further, the first, second and third slot-strip structures 312, 314, 316 are substantially U-shaped.

**[0031]** As shown, the multi-band slot-strip antenna 300 also includes a signal feed pin 304, and first and second signal grounding pins 306a, 306b. The signal feed pin 304 is connected to the first minor arm portion 318a of the first slot-strip structure 312, 314, in close proximity to the open end of the first non-conductive slot 332. The first signal ground pin 306a is connected to the second minor arm portion 320a of the first and second slot-strip structures 312, 314, in close proximity to the signal feed pin 304 and the open end of the first non-conductive slot 332. The first signal ground pin 306a is also proximate the third base portion 330 of the third slot-strip structure 316.

**[0032]** The second signal ground pin 306b is connected to the second linear arm 324 of the third slot-strip structure 316, in close proximity to the open end of the third non-conductive slot 336. As will become apparent, this second signal ground pin 306b extends the bandwidth of the lower frequency band of the multi-band slot-strip antenna 300 to cover most of the application bands at/near 2 GHz.

**[0033]** Preferably, the first minor arm portion 318a is substantially parallel to the second minor arm portion 320a; and the first major arm portion 318b is substantially parallel to the second major arm portion 320b. Further, preferably the first linear arm 322 is substantially parallel to the second major arm portion 320b, and the second linear arm 324 is substantially parallel to the first linear arm 322.

**[0034]** Similarly, the first minor slot portion 332a is substantially parallel to the second minor slot portion 334a. Similarly, preferably the first major slot portion 332b is substantially parallel to the second major slot portion 334b. Further, the second non-conductive slot 334 opens in substantially the same direction as the first non-conductive slot 332.

**[0035]** The third non-conductive slot 336 is preferably substantially parallel to the second major slot portion 334b of the second non-conductive slot 334. However, the third non-conductive slot 336 opens in a direction that is substantially opposite to that of the second non-conductive slot 334.

**[0036]** Further, preferably the first and second minor arm portions 318a, 320a, the first and second minor slot

portions 332a, 334a, and the rectangular base portions 326, 328, 330 are parallel to one pair of opposing edges of the conductive layer 302. In addition, preferably the first and second major arm portions 318b, 320b, the first and second linear arms 322, 324 and the rectangular base portions 326, 328, 330 are parallel to the other pair of opposing edges of the conductive layer 302.

**[0037]** Fig. 4 to 8 are computer simulations of the return loss for the multi-band slot-strip antenna 300. In these simulations:

$L_a$  is the length of the first major slot portion 332b  
 $L_b$  is the length of the second major slot portion 334b  
 $L_c$  is the length of the third non-conductive slot 336  
 $h_a$  is the width of the first major slot portion 332b  
 $h_b$  is the width of the second major slot portion 334b  
 $h_c$  is the width of the third non-conductive slot 336

**[0038]** Fig. 4 depicts the variation in return loss of the multi-band slot-strip antenna 300 with length  $L_a$ . In this simulation,  $L_b = 28.5\text{mm}$ ;  $L_c = 6.5\text{mm}$ ;  $h_a = 1\text{mm}$ ;  $h_b = 2\text{mm}$ ;  $h_c = 2\text{mm}$ ; and  $L_{a3} > L_{a2} > L_{a1}$ . This simulation reveals that the length of the first major slot portion 332b has a preferential impact on the centre frequency and impedance of the lower frequency band, in comparison to the higher frequency band. This result is advantageous since it reveals that the frequency and impedance of the lower frequency band can be adjusted by varying the length of the first slot-strip structure 312, without significantly impacting the characteristics of the upper frequency band.

**[0039]** Fig. 5 depicts the variation in return loss with length  $L_b$ . In this simulation,  $L_a = 13.5\text{mm}$ ;  $L_c = 6.5\text{mm}$ ;  $h_a = 1\text{mm}$ ;  $h_b = 2\text{mm}$ ;  $h_c = 2\text{mm}$ ; and  $L_{b4} > L_{b3} > L_{b2} > L_{b1}$ . This simulation reveals that the centre frequency, impedance and bandwidth of the upper and lower frequency bands are sensitive to variations in the length of the second major slot portion 334b.

**[0040]** Fig. 6 depicts the variation in return loss with  $L_c$ . In this simulation,  $L_a = 13.5\text{mm}$ ;  $L_b = 28.5\text{mm}$ ;  $h_a = 1\text{mm}$ ;  $h_b = 2\text{mm}$ ;  $h_c = 2\text{mm}$ ; and  $L_{c1} > L_{c2} > L_{c3} > L_{c4}$ . This simulation reveals that the impedance of the upper and lower frequency bands is sensitive to variations in the length of the third non-conductive slot 336. This result is advantageous since it reveals that the impedance of both bands can be adjusted independently of the centre frequency and bandwidth of the upper and lower frequency bands.

**[0041]** Fig. 7 is a computer simulation of the return loss for a preferred implementation of the multi-band slot-strip antenna 300, in comparison to a structure which has the same shape and dimensions but lacks the second signal grounding pin 306b. In this simulation,  $L_a = 13.5\text{mm}$ ;  $L_b = 28.5\text{mm}$ ;  $L_c = 6.5\text{mm}$ ;  $h_a = 1\text{mm}$ ;  $h_b = 2\text{mm}$ ;  $h_c = 2\text{mm}$ . This simulation reveals that the second signal grounding pin 306b adds two closely-spaced resonant frequencies to the simulated spectrum around 2GHz, which significantly increases the bandwidth of the low frequency

range from about 250MHz to about 500MHz.

**[0042]** Fig. 8 depicts the computer simulated and actual performance of a secondary multi-band slot-strip antenna 300 having the following dimensions:  $L_a = 13.5\text{mm}$ ;  $L_b = 28.5\text{mm}$ ;  $L_c = 6.5\text{mm}$ ;  $h_a = 1\text{mm}$ ;  $h_b = 2\text{mm}$ ;  $h_c = 2\text{mm}$ . This graph reveals that the multi-band slot-strip antenna 300 has an actual low frequency range that extends from 1.67 GHz to 2.34 GHz. Since the GSM1800 band (1710-1880MHz), the GSM1900 band (1850-1990MHz), the DCS band (1710-1880MHz), the PCS band (1880-1990MHz), and the UMTS band (1900-2200MHz) all fall within this enhanced low frequency range of the multi-band slot-strip antenna 300, the introduction of the second signal grounding pin 306b significantly enhances the multi-band performance of the multi-band slot-strip antenna 300. The graph also reveals that the multi-band slot-strip antenna 300 has a higher frequency (5GHz) range that is suitable for WLAN 802.11 a/j applications.

**[0043]** As will be appreciated from the foregoing discussion, the multi-band antenna 300 offers enhanced low frequency bandwidth around 2 GHz suitable for 3G communications. This result is obtained in a structure whose size is suitable for incorporation into small handheld communications devices.

**[0044]** The scope of the monopoly desired for the invention is defined by the claims appended hereto, with the foregoing description being merely illustrative of the preferred embodiment of the invention. Persons of ordinary skill may envisage modifications to the described embodiment which, although not explicitly suggested herein, do not depart from the scope of the invention, as defined by the appended claims.

## Claims

### 1. A multi-band slot-strip antenna comprising:

a planar conductive layer comprising a conductive region and a non-conductive region, the conductive region and the non-conductive region together defining a first slot-strip structure comprising a signal feed portion; a second slot-strip structure coupled to the first slot-strip structure, the second slot-strip structure comprising a first signal grounding portion; and a third slot-strip structure coupled to the second slot-strip structure, the third slot-strip structure comprising a second signal grounding portion.

### 2. The multi-band antenna according to Claim 1, wherein the slot-strip structures each have a substantially U-shape, each said U-shaped slot-strip structure comprising a pair of substantially parallel arms, a base portion joining together the arms, and a slot extending between the arms, the slot of the third slot-strip structure opening in a direction oppo-

site to that of the second slot-strip structure.

3. The multi-band antenna according to Claim 2, wherein the slot of the second slot-strip structure opens in a direction substantially the same as that of the first slot-strip structure.
4. The multi-band antenna according to Claim 2 or Claim 3, wherein the signal feed portion and the grounding portions are disposed proximate an end of one arm of the respective slot-strip structures, and the first grounding portion is disposed proximate the signal feed portion.
5. The multi-band antenna according to any one of Claims 2 to 4, wherein the first grounding portion is disposed proximate the base portion of the third slot-strip structure.
6. The multi-band antenna according to Claim 2, wherein the signal feed portion and the grounding portions are disposed proximate an end of one arm of the respective slot-strip structures, and the first grounding portion is disposed proximate the signal feed portion.
7. The multi-band antenna according to Claim 6, wherein the first grounding portion is disposed proximate the base portion of the third slot-strip structure.
8. The multi-band antenna according to any one of Claims 2 to 7, wherein the slot-strip structures are coupled together at their respective arms.
9. The multi-band antenna according to Claim 8, wherein the arms of the first slot-strip structure have a substantially L-shape.
10. The multi-band antenna according to Claim 9, wherein one arm of the second slot-strip structure has a substantially L-shape, and the other arm of the second slot-strip structure has a substantially linear shape.
11. A wireless communications device comprising:
  - a radio transceiver section; and
  - a multi-band slot-strip antenna according to any one of Claims 1 to 10, the multi-band slot-strip antenna being coupled to the radio transceiver section.
12. A multi-band slot-strip antenna comprising:
  - a planar conductive layer comprising a conductive region and a central non-conductive region, the conductive region and the non-conductive region together defining at least three mutually-

coupled slot-strip structures;  
 a feed signal pin connected to one of the slot-strip structures; and  
 a ground pin connected to the other slot-strip structures.

5

**Amended claims in accordance with Rule 137(2) EPC.**

1. A multi-band slot-strip antenna (300) comprising:

a planar conductive layer (302) comprising a conductive region (308) and defining a non-conductive region, the conductive region (308) and the non-conductive region together defining a first slot-strip structure (312) comprising a signal feed portion (304); a second slot-strip structure (314) coupled to the first slot-strip structure (312), the second slot-strip structure (314) comprising a first signal grounding portion (306a); and a third slot-strip structure (316) coupled to the second slot-strip structure (314), the third slot-strip structure (316) comprising a second signal grounding portion (306b), the second signal grounding portion (306b) being distinct from the first signal grounding portion (306a).

10

15

20

25

2. The multi-band antenna (300) according to Claim 1, wherein the slot-strip structures (312, 314, 316) each have a substantially U-shape, each said U-shaped slot-strip structure (312, 314, 316) comprising a pair of substantially parallel arms (318, 320, 322, 324), a base portion (326, 328, 330) joining together the arms (318, 320, 322, 324), and a slot (332, 334, 336) extending between the arms (318, 320, 322, 324), the slot (336) of the third slot-strip structure (316) opening in a direction opposite to that of the second slot-strip structure (314).

30

35

3. The multi-band antenna (300) according to Claim 2, wherein the slot (334) of the second slot-strip structure (314) opens in a direction substantially the same as that of the first slot-strip structure (312).

40

4. The multi-band antenna (300) according to Claim 2 or Claim 3, wherein the signal feed portion (304) and the grounding portions (306a, 306b) are disposed proximate an end of one arm (318, 320, 324) of the respective slot-strip structures (312, 314, 316), and the first grounding portion (306a) is disposed proximate the signal feed portion (304).

45

50

5. The multi-band antenna (300) according to any one of Claims 2 to 4, wherein the first grounding portion (306a) is disposed proximate the base portion (330) of the third slot-strip structure (316).

55

6. The multi-band antenna (300) according to any one of Claims 2 to 5, wherein the slot-strip structures (312, 314, 316) are coupled together at their respective arms (318, 320, 322).

7. The multi-band antenna (300) according to Claim 6, wherein the arms (318, 320) of the first slot-strip structure (312) have a substantially L-shape.

8. The multi-band antenna (300) according to Claim 7, wherein one arm (320) of the second slot-strip structure (314) has a substantially L-shape, and the other arm (322) of the second slot-strip structure (314) has a substantially linear shape.

9. The multi-band antenna (300) according to Claim 1, wherein the slot-strip structures (312, 314, 316) each comprise a pair of arms (318, 320, 322, 324), a base portion joining together the arms (318, 320, 322, 324), and a slot extending between the arms (318, 320, 322, 324), the signal feed portion (304) being provided on one of the arms (318) of the first slot-strip structure (312), another arm (320) of the first slot-strip structure (312) being common with one of the arms (320) of the second slot-strip structure (314), the first signal grounding portion (306a) being provided on the common arm (320).

10. The multi-band antenna (300) according to Claim 9, wherein another arm (322) of the second slot-strip structure (314) is common with one of the arms (322) of the third slot-strip structure (316), and the second signal grounding portion (306b) being provided on another arm (324) of the third slot-strip structure (316).

11. The multi-band antenna (300) according to Claim 10, wherein the signal feed portion (304) and the signal ground portions (306a, 306b) are provided adjacent an end of the respective arms (318, 320, 324) opposite the respective base portions (326, 328, 330).

12. A wireless communications device (200) comprising:

a radio transceiver section (214); and  
 a multi-band slot-strip antenna (300) according to any one of Claims 1 to 11, the multi-band slot-strip antenna (300) being coupled to the radio transceiver section (214).

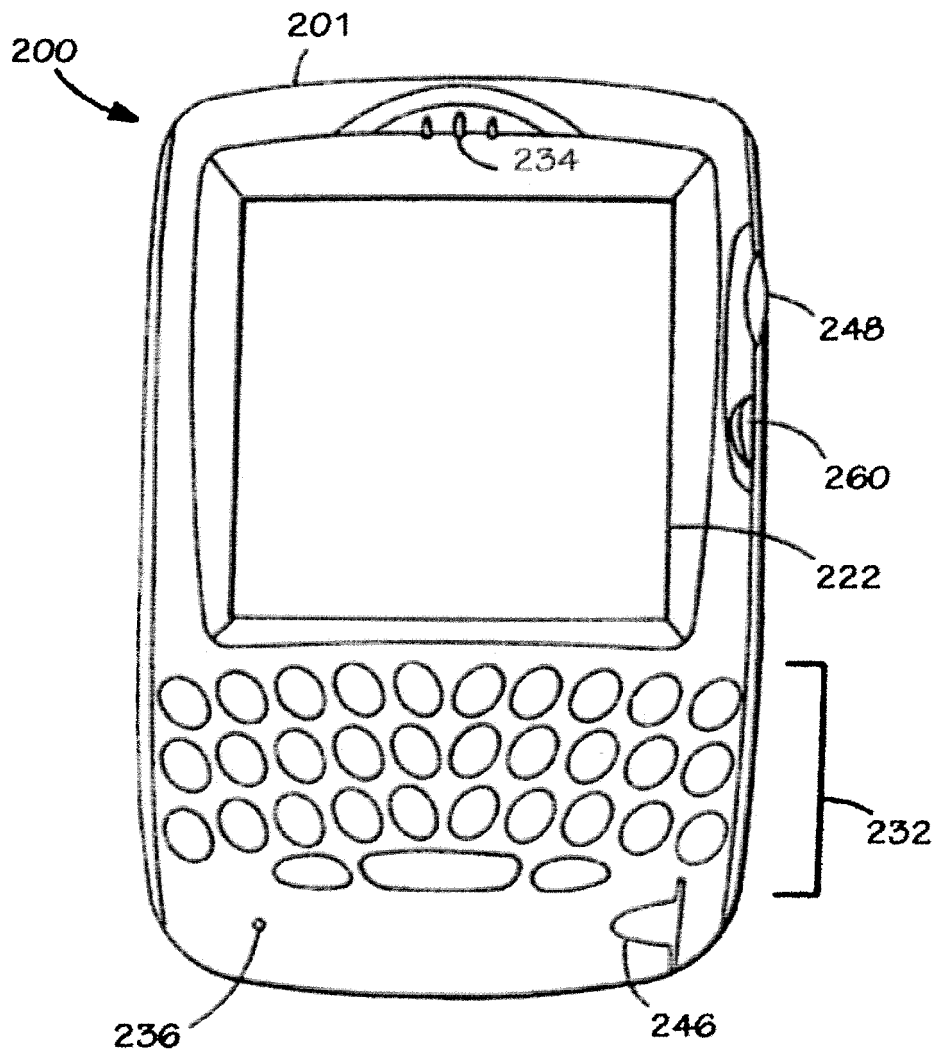

FIG. 1

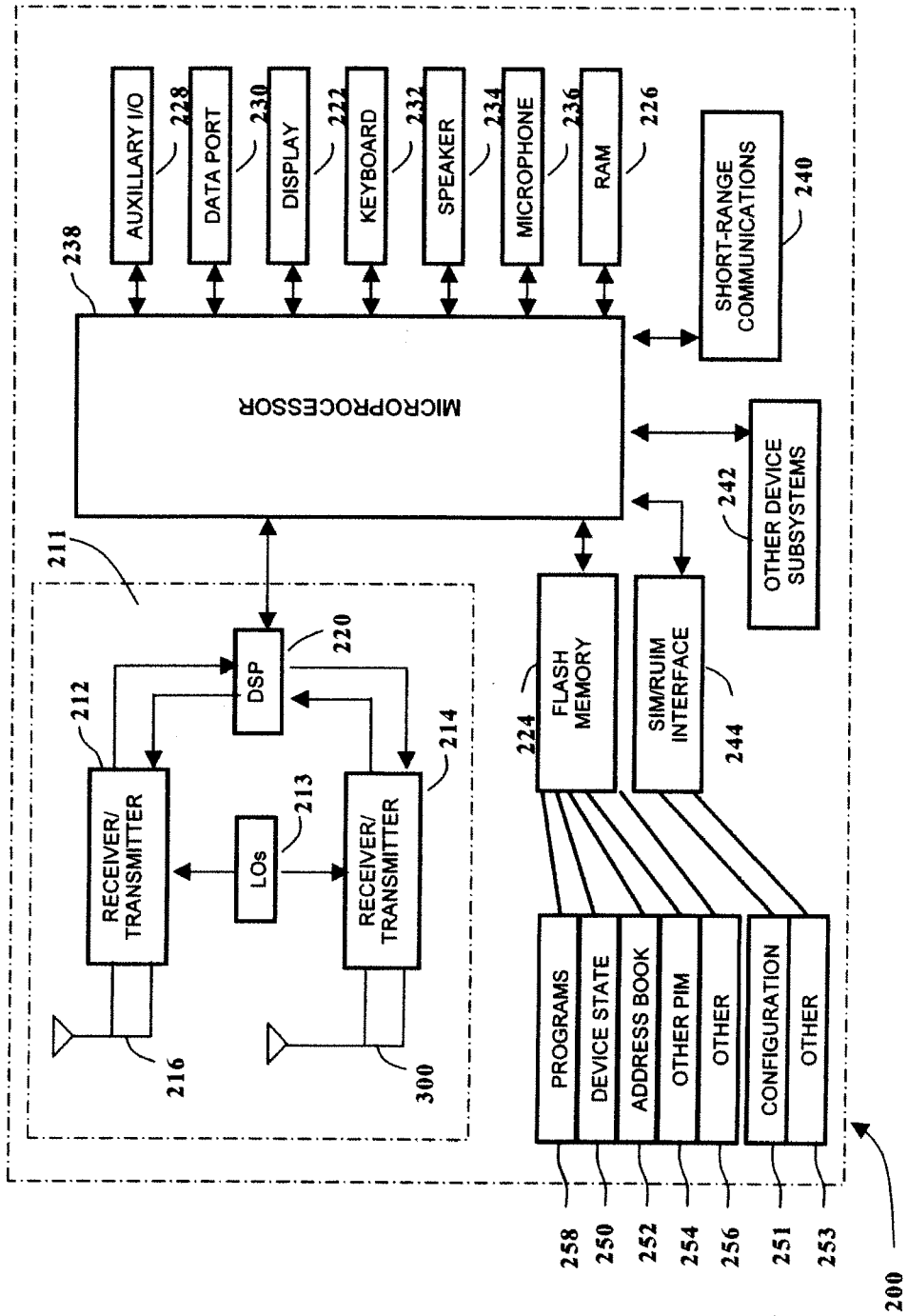

FIG. 2



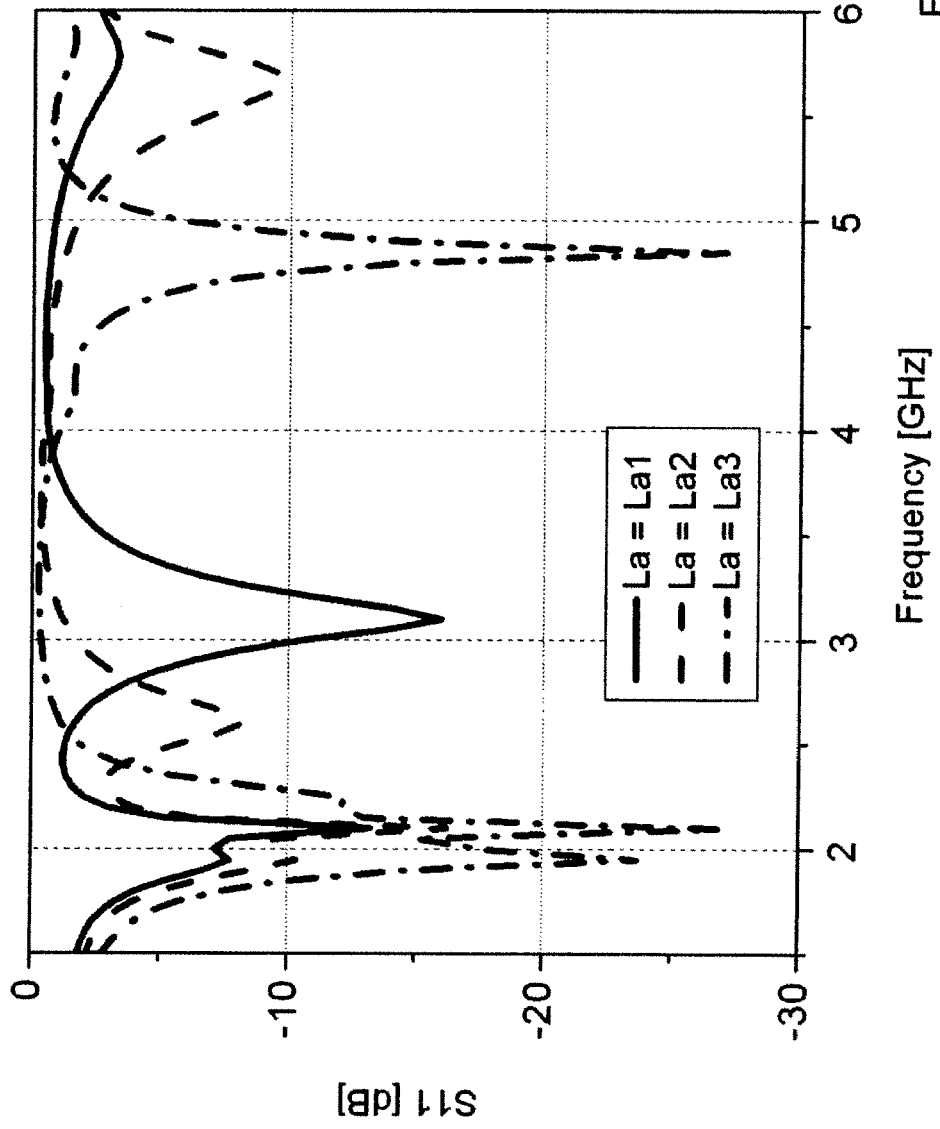

FIG. 4

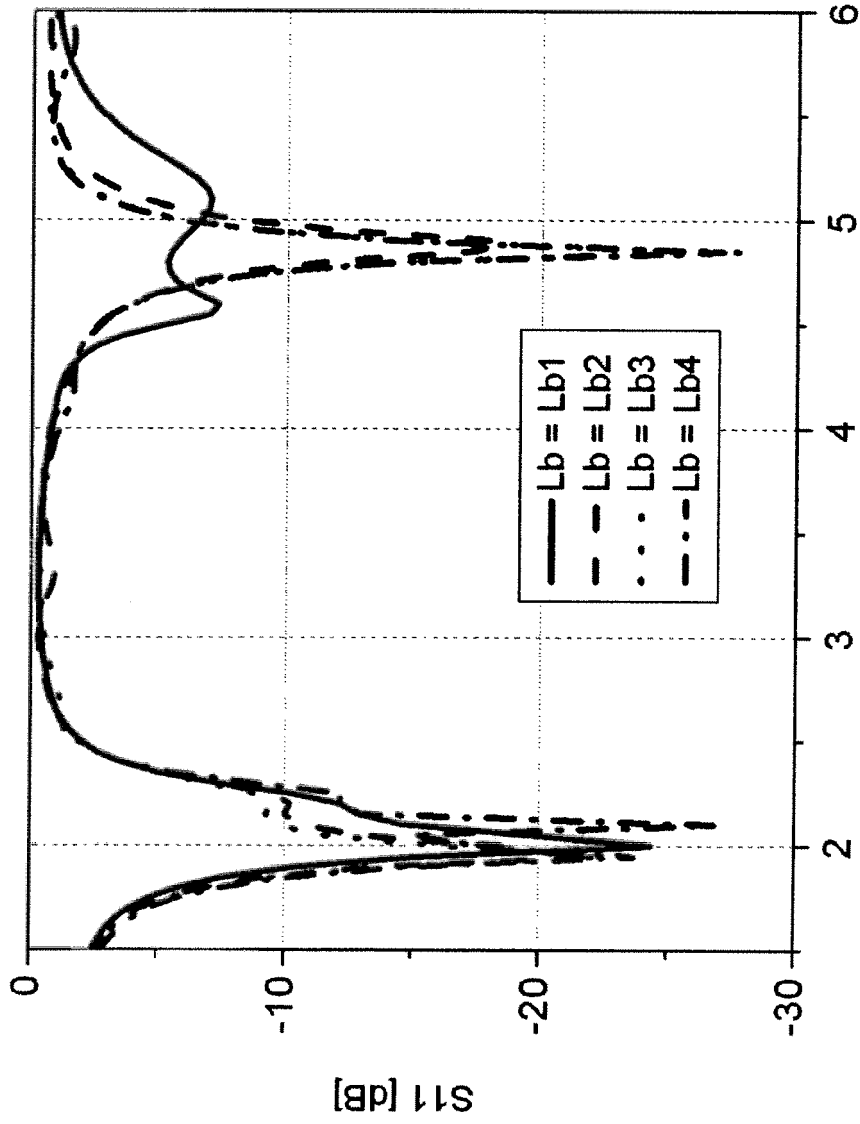

FIG. 5

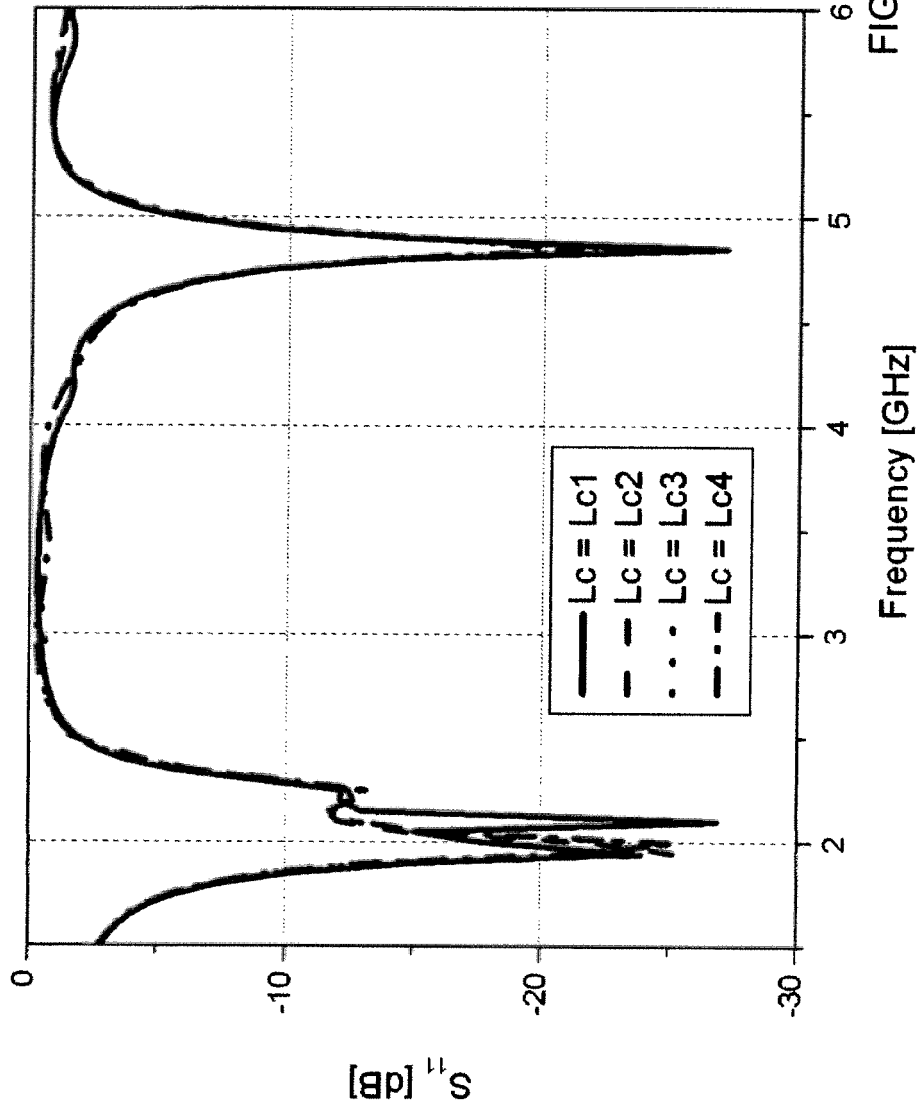

FIG. 6

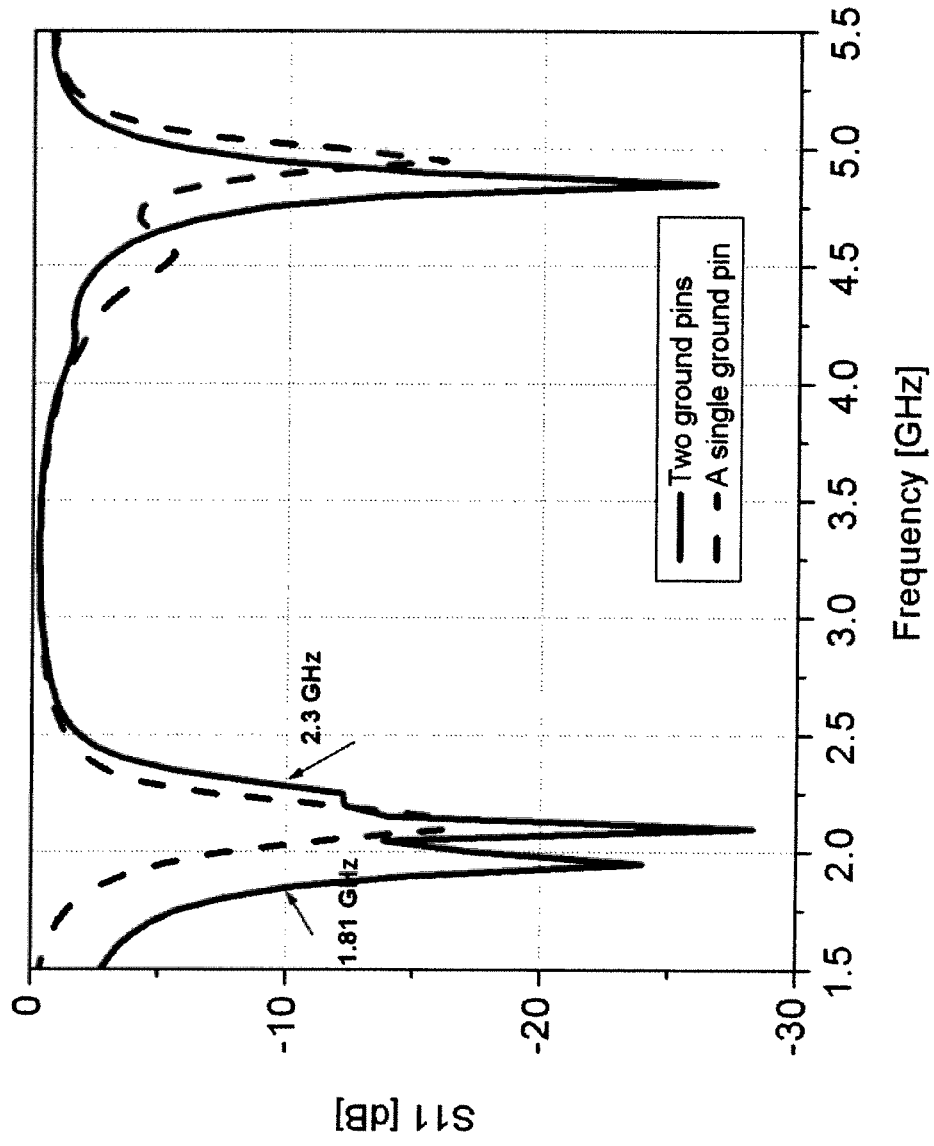

FIG. 7

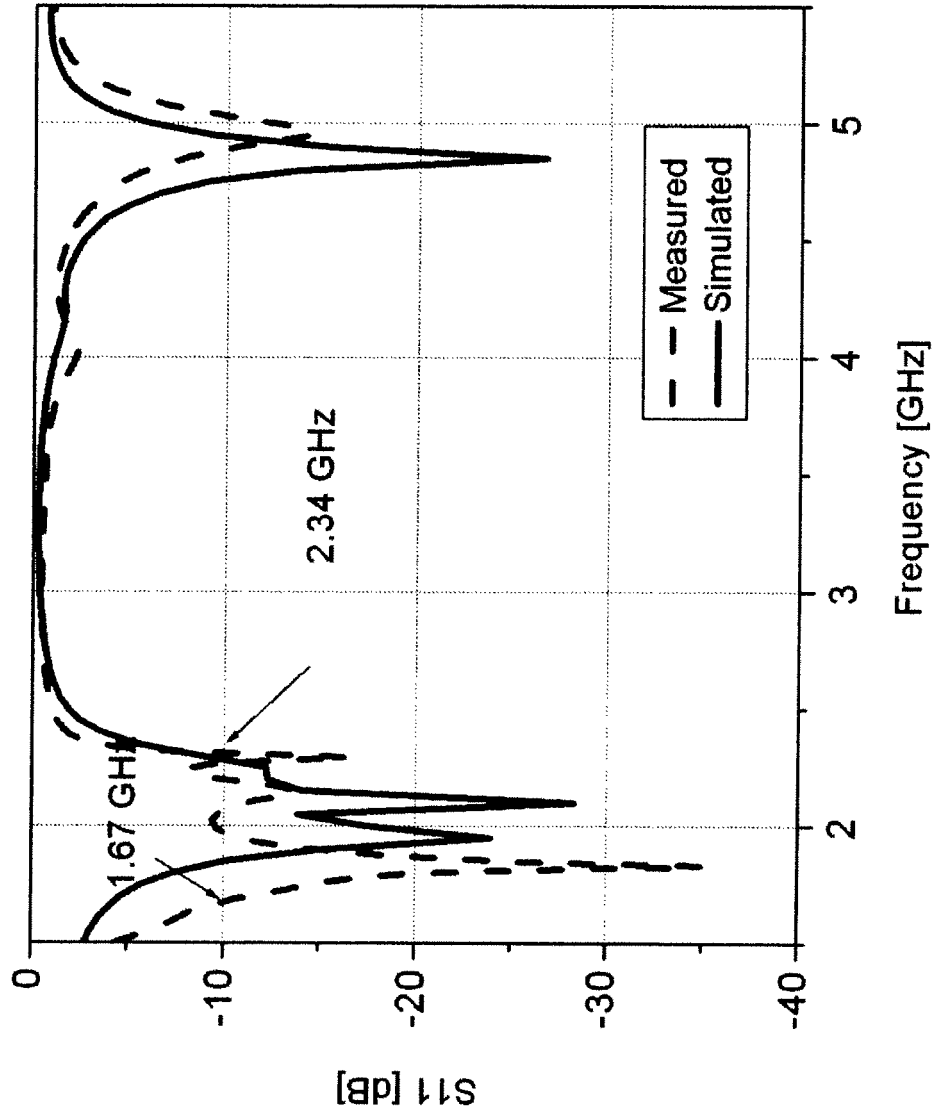

FIG. 8



DOCUMENTS CONSIDERED TO BE RELEVANT			
Category	Citation of document with indication, where appropriate, of relevant passages	Relevant to claim	CLASSIFICATION OF THE APPLICATION (IPC)
X	EP 0 923 156 A1 (CIT ALCATEL [FR]) 16 June 1999 (1999-06-16) * column 7, line 43 - column 14, line 56 * * figures 1-4 * * abstract *	1-8,11, 12	INV. H01Q9/04
X	US 2004/085244 A1 (KADAMBI GOVIND RANGASWAMY [US] ET AL) 6 May 2004 (2004-05-06) * page 9, paragraph 157 - page 10, paragraph 183 * * figures 3a,3b,3c * * abstract *	1,11,12	ADD. H01Q1/38 H01Q5/00 H01Q1/24
Y	WO 2004/049501 A (RES IN MOTION LTD [CA]; WEN GEYI [CA]; JARMUSZEWSKI PERRY [CA]; STEVEN) 10 June 2004 (2004-06-10) * page 5, line 2 - page 8, line 12 * * figure 1 * * abstract *	2-10	
Y	EP 1 304 765 A2 (FILTRONIC LK OY [FI] LK PRODUCTS OY [FI]) 23 April 2003 (2003-04-23) * page 3, column 3, line 29 - page 4, column 5, line 24 * * figures 2a-4 * * abstract *	2-10	
A		1-12	TECHNICAL FIELDS SEARCHED (IPC) H01Q
The present search report has been drawn up for all claims			
Place of search Munich		Date of completion of the search 19 July 2007	Examiner von Walter, Sven-Uwe
CATEGORY OF CITED DOCUMENTS X : particularly relevant if taken alone Y : particularly relevant if combined with another document of the same category A : technological background O : non-written disclosure P : intermediate document		T : theory or principle underlying the invention E : earlier patent document, but published on, or after the filing date D : document cited in the application L : document cited for other reasons ..... & : member of the same patent family, corresponding document	

3  
EPO FORM 1503 03-02 (P04C01)



DOCUMENTS CONSIDERED TO BE RELEVANT			
Category	Citation of document with indication, where appropriate, of relevant passages	Relevant to claim	CLASSIFICATION OF THE APPLICATION (IPC)
A	<p>KADAMBI G R ET AL: "Applications of annular and L-shaped slot in PIFA design" IEEE ANTENNAS AND PROPAGATION SOCIETY INTERNATIONAL SYMPOSIUM. 2003 DIGEST. APS. COLUMBUS, OH, JUNE 22 - 27, 2003, NEW YORK, NY : IEEE, US, vol. VOL. 4 OF 4, 22 June 2003 (2003-06-22), page 86, XP010747200 ISBN: 0-7803-7846-6 * the whole document *</p> <p style="text-align: center;">-----</p>	1-12	
			TECHNICAL FIELDS SEARCHED (IPC)
The present search report has been drawn up for all claims			
Place of search <b>Munich</b>		Date of completion of the search <b>19 July 2007</b>	Examiner <b>von Walter, Sven-Uwe</b>
<p>CATEGORY OF CITED DOCUMENTS</p> <p>X : particularly relevant if taken alone Y : particularly relevant if combined with another document of the same category A : technological background O : non-written disclosure P : intermediate document</p>		<p>T : theory or principle underlying the invention E : earlier patent document, but published on, or after the filing date D : document cited in the application L : document cited for other reasons ..... &amp; : member of the same patent family, corresponding document</p>	

3

EPO FORM 1503 03.82 (P04C01)

ANNEX TO THE EUROPEAN SEARCH REPORT  
ON EUROPEAN PATENT APPLICATION NO.

EP 07 10 4442

This annex lists the patent family members relating to the patent documents cited in the above-mentioned European search report. The members are as contained in the European Patent Office EDP file on  
The European Patent Office is in no way liable for these particulars which are merely given for the purpose of information.

19-07-2007

Patent document cited in search report		Publication date	Patent family member(s)	Publication date
EP 0923156	A1	16-06-1999	AT 258720 T	15-02-2004
			AU 743872 B2	07-02-2002
			AU 9610198 A	01-07-1999
			CA 2254263 A1	11-06-1999
			CN 1226093 A	18-08-1999
			DE 69821327 D1	04-03-2004
			DE 69821327 T2	18-11-2004
			ES 2210690 T3	01-07-2004
			FR 2772518 A1	18-06-1999
			JP 11284430 A	15-10-1999
			SG 77208 A1	19-12-2000
			TW 404081 B	01-09-2000
			US 6133880 A	17-10-2000
-----				
US 2004085244	A1	06-05-2004	NONE	
-----				
WO 2004049501	A	10-06-2004	AU 2002347147 A1	18-06-2004
			CA 2507520 A1	10-06-2004
			CN 1695268 A	09-11-2005
			EP 1573856 A1	14-09-2005
			US 2004201530 A1	14-10-2004
-----				
EP 1304765	A2	23-04-2003	AT 320089 T	15-03-2006
			CN 1414809 A	30-04-2003
			DE 60209686 T2	16-11-2006
			FI 20012045 A	23-04-2003
			US 2003076268 A1	24-04-2003
-----				

**REFERENCES CITED IN THE DESCRIPTION**

*This list of references cited by the applicant is for the reader's convenience only. It does not form part of the European patent document. Even though great care has been taken in compiling the references, errors or omissions cannot be excluded and the EPO disclaims all liability in this regard.*

**Patent documents cited in the description**

- US 7006048 B [0003]
- US 6677909 B [0003]