

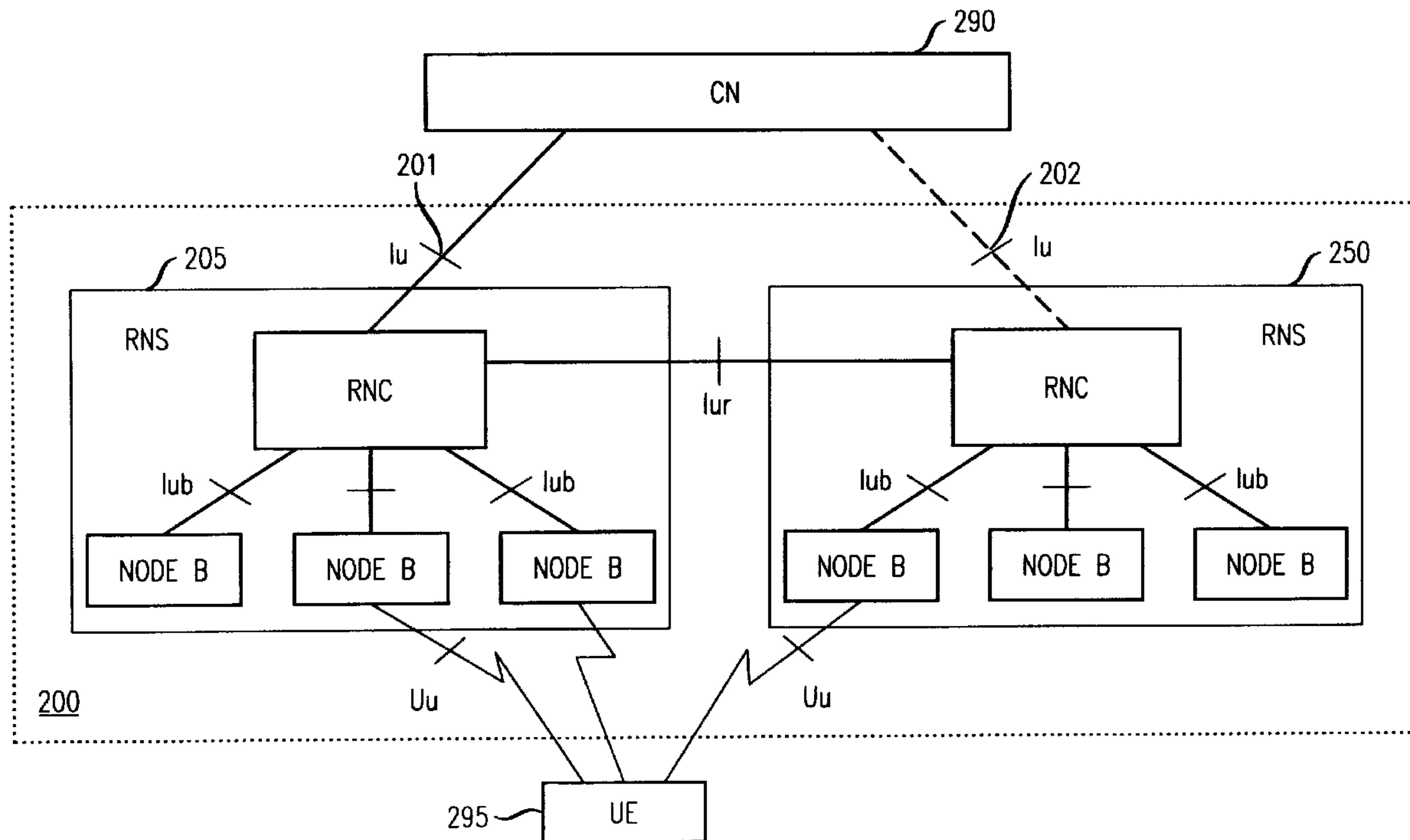

(22) Date de dépôt/Filing Date: 2001/08/30
 (41) Mise à la disp. pub./Open to Public Insp.: 2002/03/21
 (45) Date de délivrance/Issue Date: 2006/06/06
 (30) Priorité/Priority: 2000/09/21 (US09/666,809)

(51) Cl.Int./Int.Cl. *H04L 12/66* (2006.01),
H04Q 7/36 (2006.01), *H04L 29/06* (2006.01),
H04L 12/56 (2006.01), *H04L 29/08* (2006.01)
 (72) Inventeurs/Inventors:
 ABRAHAM, SANTOSH P., US;
 CHUAH, MOOI CHOO, US;
 MEDAPALLI, KAMESWARA RAO, US;
 SAMPATH, ASHWIN, US
 (73) Propriétaire/Owner:
 LUCENT TECHNOLOGIES INC., US
 (74) Agent: KIRBY EADES GALE BAKER

(54) Titre : AMELIORATION DE LA STRUCTURE DE TRAME DU PROTOCOLE DE VERROUILLAGE DE TRAMES
 POUR APPUYER LA QUALITE DE SERVICE
 (54) Title: ENHANCEMENT OF FRAMING PROTOCOL FRAME FORMAT TO SUPPORT QUALITY OF SERVICE



(57) **Abrégé/Abstract:**

In a UMTS (universal mobile telecommunications system) Terrestrial Radio Access Network (UTRAN) based wireless system, a wireless network element (e.g., a base station) exchanges information with another wireless network element (e.g., a radio network controller) via data frames (uplink or downlink). Each data frame comprising a header portion and a payload portion, which comprises a QoS class indicator field. Illustratively, the eight bit spare extension field of a UTRAN data frame (uplink or downlink) is used to convey a four bit payload type indicator and a four bit QoS class indicator.

ENHANCEMENT OF FRAMING PROTOCOL FRAME FORMAT TO SUPPORT QUALITY OF SERVICE

ABSTRACT

In a UMTS (universal mobile telecommunications system) Terrestrial Radio Access Network (UTRAN) based wireless system, a wireless network element (e.g., a base station) exchanges information with another wireless network element (e.g., a radio network controller) via data frames (uplink or downlink). Each data frame comprising a header portion and a payload portion, which comprises a QoS class indicator field. Illustratively, the eight bit spare extension field of a UTRAN data frame (uplink or downlink) is used to convey a four bit payload type indicator and a four bit QoS class indicator.

ENHANCEMENT OF FRAMING PROTOCOL FRAME FORMAT TO SUPPORT QUALITY OF SERVICE

FIELD OF THE INVENTION

This invention relates generally to communications and, more particularly, to
5 packet communications systems.

BACKGROUND OF THE INVENTION

The wireless market is continuing to grow, and is now beginning to support a
diverse set of applications (e.g., in addition to cellular telephones, it is now possible to
purchase small hand-held devices such as the Palm VII™, which provide access to the
10 Internet via a wireless connection to a service provider.) As part of the ongoing wireless
development, the 3rd Generation Partnership Project (3GPP) is working on a UMTS
(universal mobile telecommunications system) Terrestrial Radio Access Network
(UTRAN). (3GPP is a standards body comprising the European Telecommunication
Standards Institution (ETSI) and several other international standards bodies.

15

Currently, in UTRAN, data transmissions between a "Node B" (NB) (also referred
to herein as a base station) and a radio network controller (RNC)) are defined by
dedicated transport channel (DCH) frame protocol (FP) procedures (referred to in
UTRAN as the *Iub* interface). (As used herein, both the NB and the RNC are also
20 representative of wireless network elements.) In particular, the FP procedures define
uplink (from an NB to an RNC) and downlink (from an RNC to an NB) data frames.
Each data frame (uplink or downlink) comprises a header portion and a payload portion
(also referred to as a protocol data unit (PDU)), and supports multiplexing a number of
DCHs in the payload portion. Each DCH comprises transport blocks (TBs), which are the
25 basic units used to convey data. The size and number of TBs in each DCH of a data frame
is identified by an associated transport format indicator (TFI) in the header portion of the
data frame. It should also be noted that these DCH FP procedures also apply to
communications between RNCs (referred to in UTRAN as the *Iur* interface).

SUMMARY OF THE INVENTION

In accordance with one aspect of the present invention there is provided a method for use in a node of a UMTS (universal mobile telecommunications system) Terrestrial Radio Access Network (UTRAN) based network for exchanging data with another node of the UTRAN based network, the method comprising the steps of: formatting data into a UTRAN data frame, the UTRAN data frame comprising a header portion, and a payload portion comprising a payload indicator type field and a quality of service (QoS) field associated with the payload portion, wherein the payload type indicator field is used in conjunction with the QoS field to indicate a type of quality of service to be provided for the data; and transmitting the UTRAN data frame to the other node.

In accordance with another aspect of the present invention there is provided a system for use in a node of a UMTS (universal mobile telecommunications system) Terrestrial Radio Access Network (UTRAN) based network for exchanging data with another node of the UTRAN based network, the system comprising: a formatter operable to format data into a UTRAN data frame, the UTRAN data frame comprising a header portion, and a payload portion comprising a payload type indicator field and a quality of service (QoS) field associated with the payload portion, wherein the payload type indicator field is used in conjunction with the QoS field to indicate a type of quality of service to be provided for the data; and a transmitter operable to transmit the UTRAN data frame to the other node.

Notwithstanding the association of a TFI field with each DCH in a UTRAN data frame for specifying, effectively, the size of each DCH in the payload portion of the data frame, we have realized that it is also advantageous to further associate each payload of a data frame with a Quality of Service (QoS). Therefore, and in accordance with embodiments of the invention, a node of a UTRAN based network formats data into a UTRAN data frame comprising a header portion, a payload portion and a quality of service field associated with the payload portion for transmission to another node of the UTRAN-based network.

In other embodiments of the invention, a wireless network element (e.g., a base station) exchanges information with another wireless network element (e.g., a radio network controller) via data frames (uplink or downlink). Each data frame comprising a header portion and a payload portion, which comprises a QoS field (or QoS indicator).

In other embodiments of the invention, the eight bit spare extension field of a UTRAN data frame (uplink or downlink) is used to convey a four bit payload type indicator and a four bit QoS class indicator.

5

BRIEF DESCRIPTION OF THE DRAWING

FIGs. 1 and 2 show prior art UTRAN data frames (uplink and downlink);

FIGs. 3 and 4 show illustrative UTRAN data frames (uplink and downlink) in accordance with the principles of the invention;

10 FIG. 5 shows a portion of a UTRAN based wireless system in accordance with the principles of the invention;

FIG. 6 illustrates a protocol layer of use in accordance with the principles of the invention; and

15 FIG. 7 shows an illustrative high-level block diagram of a wireless network element for use in accordance with the principles of the invention.

DETAILED DESCRIPTION

The inventive concept is described in the context of a UMTS (universal mobile telecommunications system) Terrestrial Radio Access Network (UTRAN) based wireless
20 network but is not so limited. Other than the inventive concept, the details of a UTRAN

based wireless network are well known and are not described herein. Further, the inventive concept is implemented using conventional programming techniques, which as such, will not be described herein.

5 As reference, two prior art UTRAN data frames are shown in FIGs. 1 and 2 (e.g., see Technical Specification (TS) 25.427 V.3.3.0: UTRAN Iub/Iur Interface User Plane Protocol for DCH Data Streams for more information about the fields shown in FIGs. 1 and 2). FIG. 1 shows an illustrative UTRAN uplink data frame 11. The latter comprises a header portion 12 and a payload portion 14. The header portion 12 further comprises a
10 header cyclic redundancy check (CRC) field (7 bits), a frame type (FT) field (1 bit), a connection frame number (CFN) field (8 bits), and at least one transport format indicator (TFI) field (8 bits) associated with a respective DCH conveyed in the payload portion 14. A particular value of each TFI field describes, effectively, the size of the associated DCH, i.e., transport block (TB) length and TB set size. As noted earlier, the payload portion 14
15 supports multiplexing a number of DCHs. This is illustrated by FIG. 1 by the "first DCH" and the "last DCH" portions of payload 14. (For reference purposes, each DCH portion comprises a number of transport blocks (TBs) as illustrated in FIG. 1 for the first DCH of FIG. 1. It may be necessary to insert padding at the end of each TB, as represented by the P field (which although shown as a single bit in FIG. 1, is any number of bits necessary to
20 make a TB an integer number of octets).) Following the DCHs is a quality estimate field (QE) (8 bits), a group of CRC indicator (CRCI) bits (there is one CRCI bit for each TB), a spare extension field (8 bits) and, optionally, a payload checksum field (16 bits).

In a similar fashion, FIG. 2 shows an illustrative UTRAN downlink data frame 21. The latter comprises a header portion 22 and a payload portion 24. The header portion 22
25 further comprises a header cyclic redundancy check (CRC) field (7 bits), a frame type (FT) field (1 bit), a connection frame number (CFN) field (8 bits), and at least one transport format indicator (TFI) field (8 bits) associated with a respective DCH conveyed in the payload portion 24. Like downlink frame 11, the payload portion 24 supports multiplexing a number of DCHs. Following the DCHs is a spare extension field (8 bits)
30 and, optionally, a payload checksum field (16 bits).

Notwithstanding the association of a TFI field with each DCH in a UTRAN data frame for specifying, effectively, the size of each DCH in the payload portion of the data frame, we have realized that it is also advantageous to further associate each payload of a data frame with a Quality of Service (QoS). Therefore, and in accordance with the invention, a node of a UTRAN based network formats data into a UTRAN data frame comprising a header portion and a payload portion, which comprises a quality of service field associated with the payload portion for transmission to another node of the UTRAN-based network.

Illustrative uplink and downlink UTRAN data frames modified in accordance with the principles of the invention are shown in FIGs. 3 and 4 for use over either the *Iub* or the *Iur* interface. Other than the inventive concept, the structure of these uplink and downlink UTRAN data frames is similar to the data frames shown in FIGs. 1 and 2, and, as such, this structure will not be described again. FIG. 3 illustrates a UTRAN uplink data frame 401 comprising a header portion 412 and a payload portion 414. The payload portion includes, in accordance with the invention, a payload type indicator (PTI) field (4 bits) and a QoS field (4 bits). Thus, a value of each PTI field represents the type of payload and a value of the QoS field indicates a type of QoS to be provided by wireless network elements for that payload. Turning now to FIG. 4, this figure illustrates a UTRAN downlink data frame 501 comprising a header portion 512 and a payload portion 514. Similar to uplink payload portion 414, the payload portion 514 includes a payload type indicator (PTI) field (4 bits) and a QoS field (4 bits). Thus, a value of each PTI field represents the type of payload and a value of the QoS field indicates a type of QoS to be provided by wireless network elements for that payload.

A portion of a UTRAN based wireless system in accordance with the principles of the invention is shown in FIG. 5. Other than the inventive concept, the elements and interfaces shown in FIG. 5 are well-known and will not be described in detail (e.g., see Technical Specification (TS) 25.401 V.3.3.0: UTRAN Overall Description for more information). UTRAN 200 is coupled to a core network (CN) 290 via an *Iu* interface. (It should be noted that the core network may be split into separate domains, e.g., a circuit switched core network and a packet switched core network. In this case, there is one *Iu*

interface for each domain. The core network represents, e.g., other servers and gateways for providing access to the public switched telephone network and/or packet networks (like the Internet.) UTRAN 200 is also coupled to user equipment (UE) (e.g., a wireless mobile endpoint like a telephone and/or computer), as represented by UE 295, via interface *Uu*. UTRAN 200 comprises, e.g., a number of radio network subsystems (RNS) as represented by RNS 205 and RNS 250, which are coupled together via an *Iur* interface. Each RNS comprises at least one radio network controller (RNC), and at least one Node B (NB). A Node B (as noted above also referred to as a base station) is coupled to an RNC through an *Iub* interface and is coupled to a UE through a *Uu* interface. For each connection between user equipment and the UTRAN, one RNS is the Serving RNS (here, illustratively, RNS 205, which communicates via *Iu* 201 with CN 290). Another RNS could be what is referred to as a Drift RNS (here, illustratively, RNS 250, which, if necessary, communicates via *Iu* 202 with CN 290). In accordance with the inventive concept, communications over the *Iub* interface and/or the *Iur* interface utilize an modified FP PDU as illustrated in FIG. 3 for uplink communications and FIG. 4 for downlink communications wherein at least a QoS field is associated with each payload type. (It should be observed from FIGs. 3 and 4 that although considered part of the payload portion of the data frame, the QoS field could instead be included in another part of the data frame, e.g., the header portion.) It should also be noted that the inclusion of a QoS field in an FP PDU facilitates scheduling at not only the *Iub* interface, but also the *Iur* interface.

Illustratively, the QoS field is four bits wide. However, not all of the sixteen possible values need be defined. For example, UMTS allows definition of four QoS classes: conversational, streaming, interactive and background. With respect to the payload type indicator field (also illustratively defined herein as four bits wide), this field is useful to associate different payload types with a particular QoS. As such, an RNS can now utilize QoS information for multiplexing those dedicated transport channels having the same QoS into the same FP PDU.

Turning now to FIG. 6, it should be observed than an FP PDUs can be multiplexed within an IP (Internet protocol) packet. In particular, this figure illustrates an AAL2/IP

(Internet Protocol) multiplexing sublayer of a UTRAN wireless system. (An ATM Adaptation Layer (AAL) maps the services offered by a network to the services required by the application. There are a number of industry standards and proposed standards covering various AALs. In particular, "B-ISDN ATM Adaptation Layer Type 2 Specification," draft Recommendation I.363.2, November 1996, of ITU-T (herein referred to as AAL2).) As such, an IP multiplexing sublayer can decide whether or not to multiplex the FP PDUs within an IP packet and decide also on the IP Diffserv CodePoints to carry the encapsulated FP PDUs. (Information on Expedited Forwarding (EF) Service, Assured Forwarding (AF) Service, differential service codepoints can be found in, e.g., "An Architecture for Differentiated Services," RFC2475, December 1998 by S. Blake, et al.; "An Expedited Forwarding PHB", draft-ietf-diffserv-phb-ef-01.txt, Nov 1998, by V. Jacobson, et al., and "Assured Forwarding PHB Group", draft-ietf-diffserv-af-03.txt, Dec 1998, by J. Heinanen, et al.) For example, an FP QoS class can be set to a value of 0 to indicate "conversational," a value of 1 to indicate "Streaming audio," a value of 2 to indicate "streaming video," a value of 3 to indicate "interactive," and a value of 4 to indicate "Background." Then, the IP multiplexing sublayer can decide to mark the PTI field of the encapsulated FP PDU packet (which is an IP packet) with an EF code point if it is conversational class, or with an appropriate AF codepoint if it is interactive class etc. Alternatively, the FP QoS can be set to class 0 to be raw voice, class 1 to be compressed RTP/UDP/IP packets carrying voice, class 2 to streaming audio, class 3 to streaming video, class 4-6 for interactive, class 7 to background etc. Then, the appropriate multiplexed header is used for raw voice, compressed RTP/UDP/IP packets that carry conversational voice, streaming audio or streaming video.

Turning briefly to FIG. 7, a high-level block diagram of a representative wireless network element 605 for use in accordance with the principles of the invention is shown. Wireless network element 605 is a stored-program-control based processor architecture and includes processor 650, memory 660 (for storing program instructions and data, e.g., for forming the above-described data frames illustrated in FIGs. 3 and 4, etc.) and communications interface(s) 665 for coupling to one or more packet communication paths as represented by path 666 (e.g., 665 represents a transmitter and a receiver). In the

context of this invention, e.g., processor 650 and memory 660 represent a formatter for forming the data frames illustrated in FIGs. 3 and 4 for transmission via communications interface 665, representative of a radio frequency transmitter.

5 The foregoing merely illustrates the principles of the invention and it will thus be appreciated that those skilled in the art will be able to devise numerous alternative arrangements which, although not explicitly described herein, embody the principles of the invention and are within its spirit and scope. For example, although illustrated in the context of a UTRAN-based wireless system, the inventive concept is applicable to any system (e.g., wired, etc.) that addresses QoS.

CLAIMS:

1. A method for use in a node of a UMTS (universal mobile telecommunications system) Terrestrial Radio Access Network (UTRAN) based network for exchanging data with another node of the UTRAN based network, the method
5 comprising the steps of:

formatting data into a UTRAN data frame, the UTRAN data frame comprising a header portion, and a payload portion comprising a payload indicator type field and a quality of service (QoS) field associated with the payload portion, wherein the payload type indicator field is used in conjunction with the QoS field to indicate a type of quality of
10 service to be provided for the data; and

transmitting the UTRAN data frame to the other node.

2. The method of claim 1 wherein the payload portion comprises a number of dedicated channels (DCHs), each dedicated channel comprising a number of transport blocks (TBs), and wherein the header portion comprises a number of transport format indicators (TFI) fields each associated with one of the number of DCHs, each TFI indicating
15 a size of one of the number of DCHs.

3. A system for use in a node of a UMTS (universal mobile telecommunications system) Terrestrial Radio Access Network (UTRAN) based network for exchanging data with another node of the UTRAN based network, the system
20 comprising:

a formatter operable to format data into a UTRAN data frame, the UTRAN data frame comprising a header portion, and a payload portion comprising a payload type indicator field and a quality of service (QoS) field associated with the payload portion, wherein the payload type indicator field is used in conjunction with the QoS field to indicate
25 a type of quality of service to be provided for the data; and

a transmitter operable to transmit the UTRAN data frame to the other node.

FIG. 1

PRIOR ART

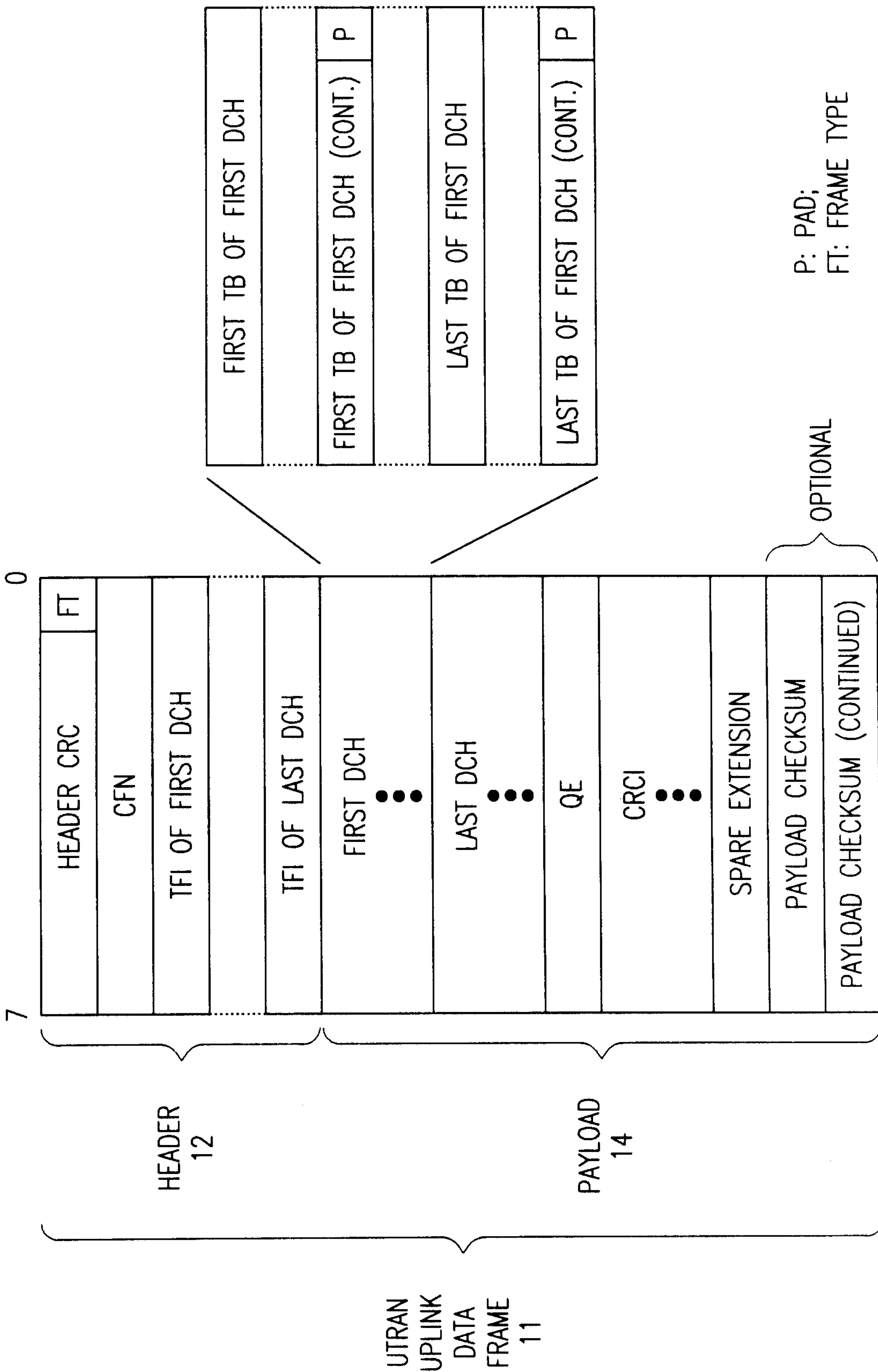

FIG. 2

PRIOR ART

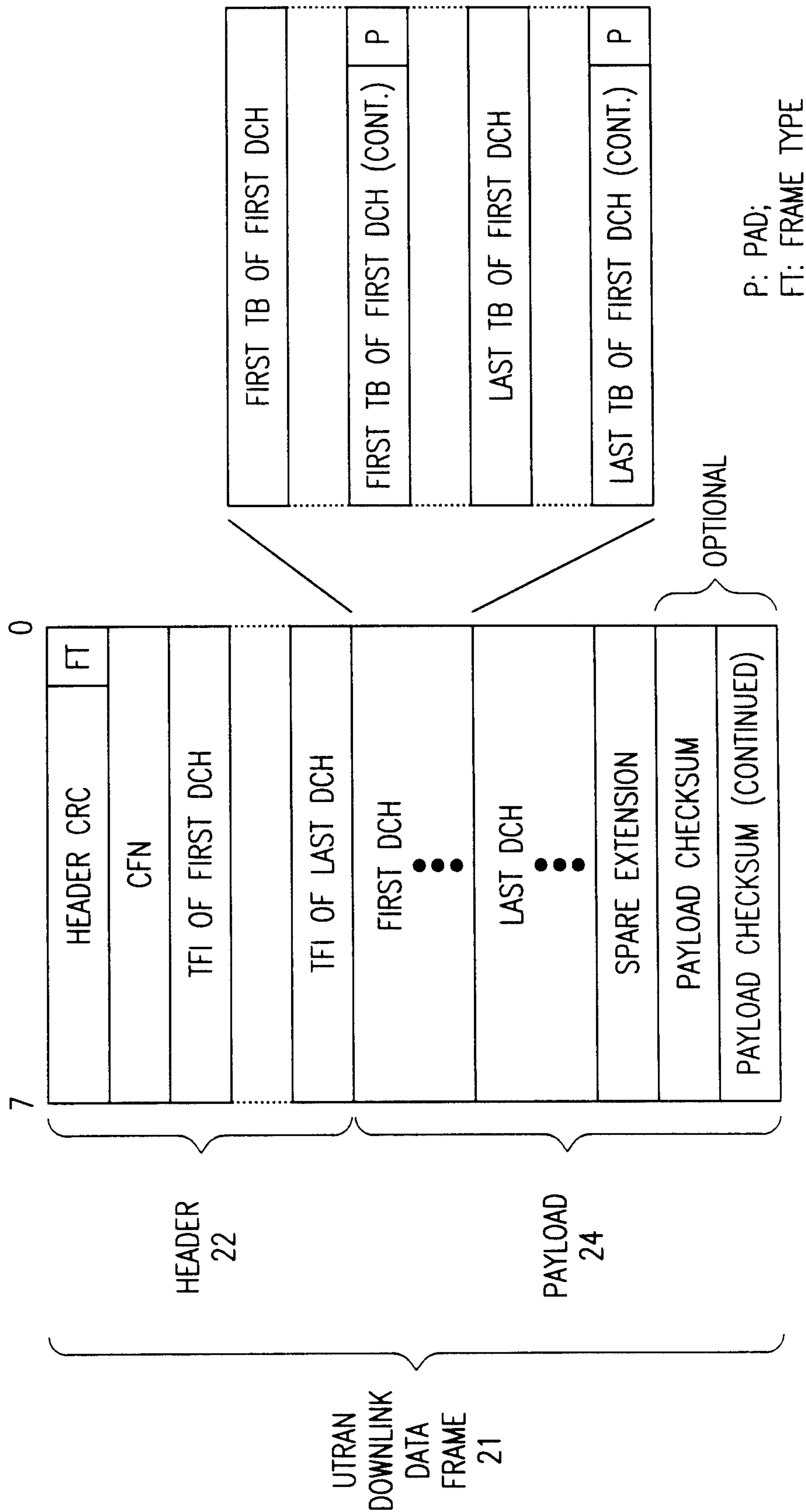

FIG. 3

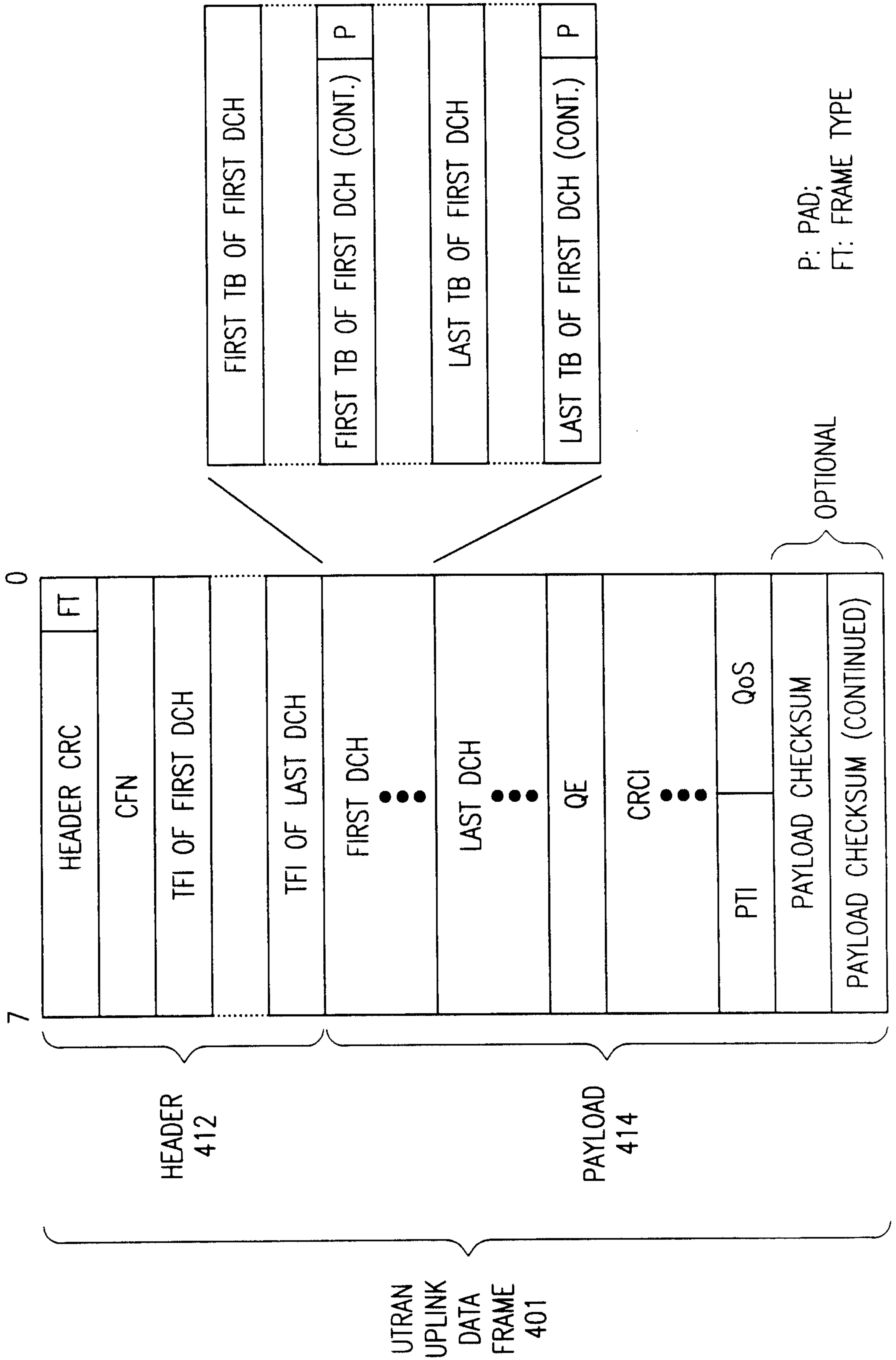

FIG. 4

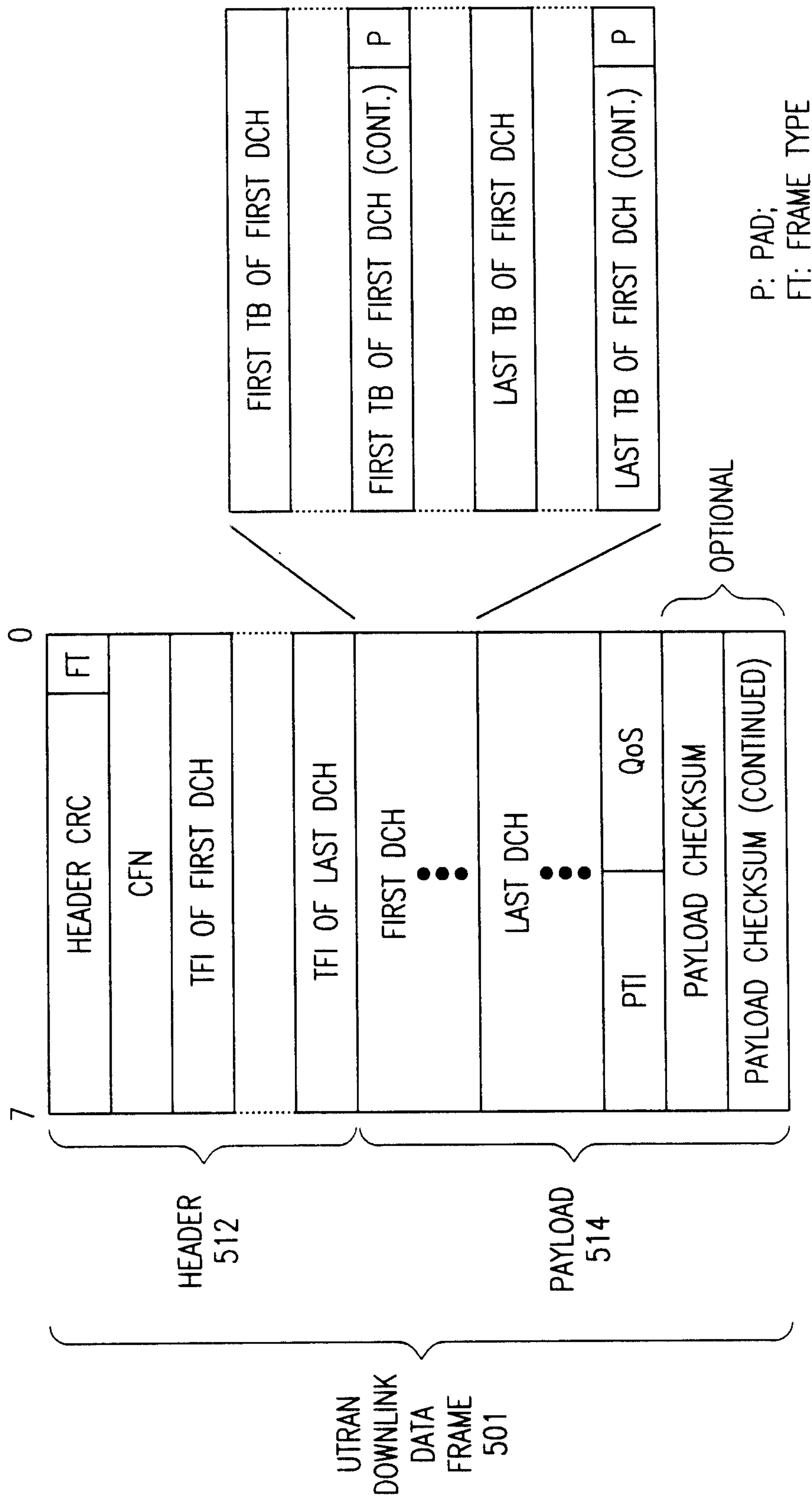
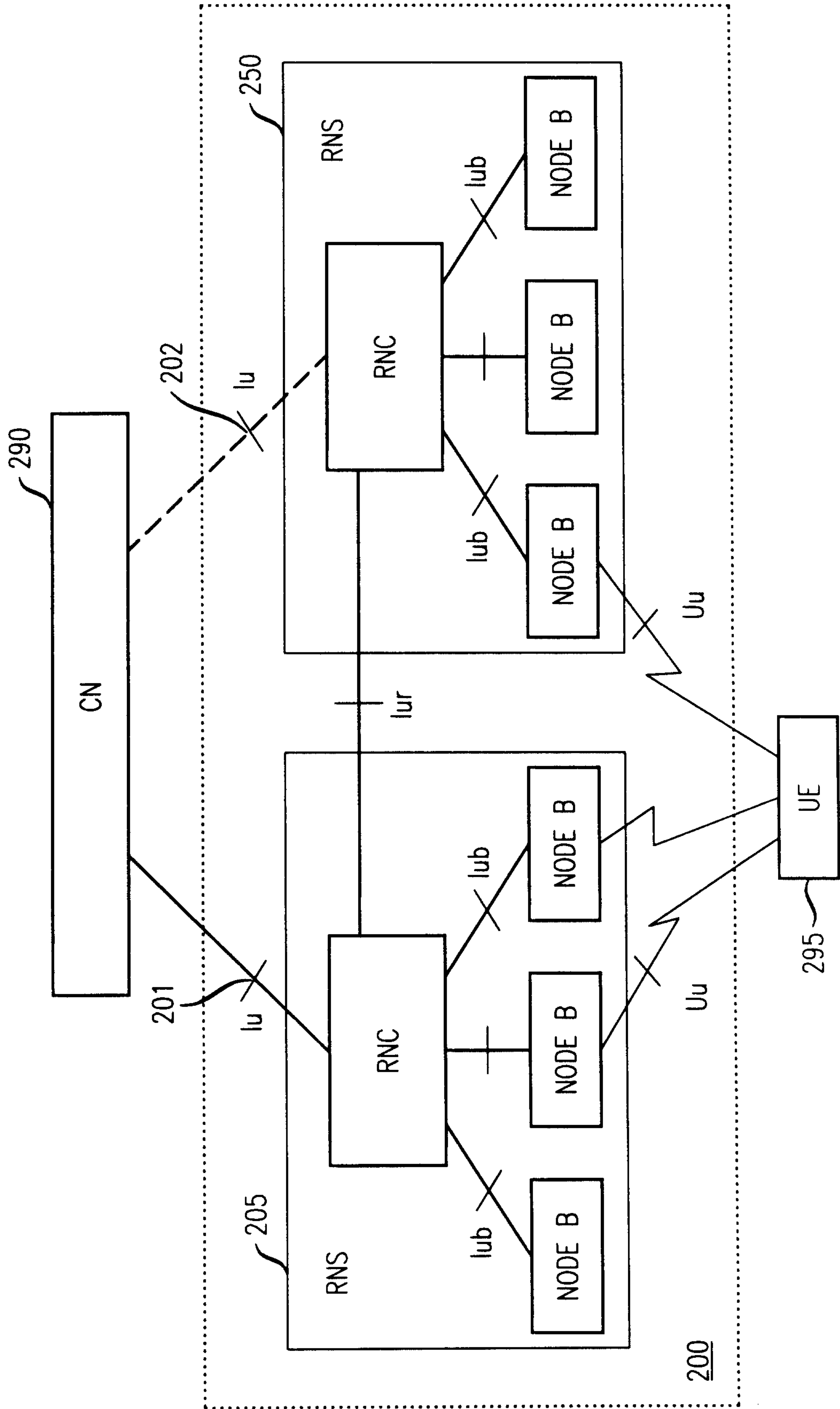

FIG. 5



S.P. ABRAHAM 3-52-2-6

6/6

FIG. 6

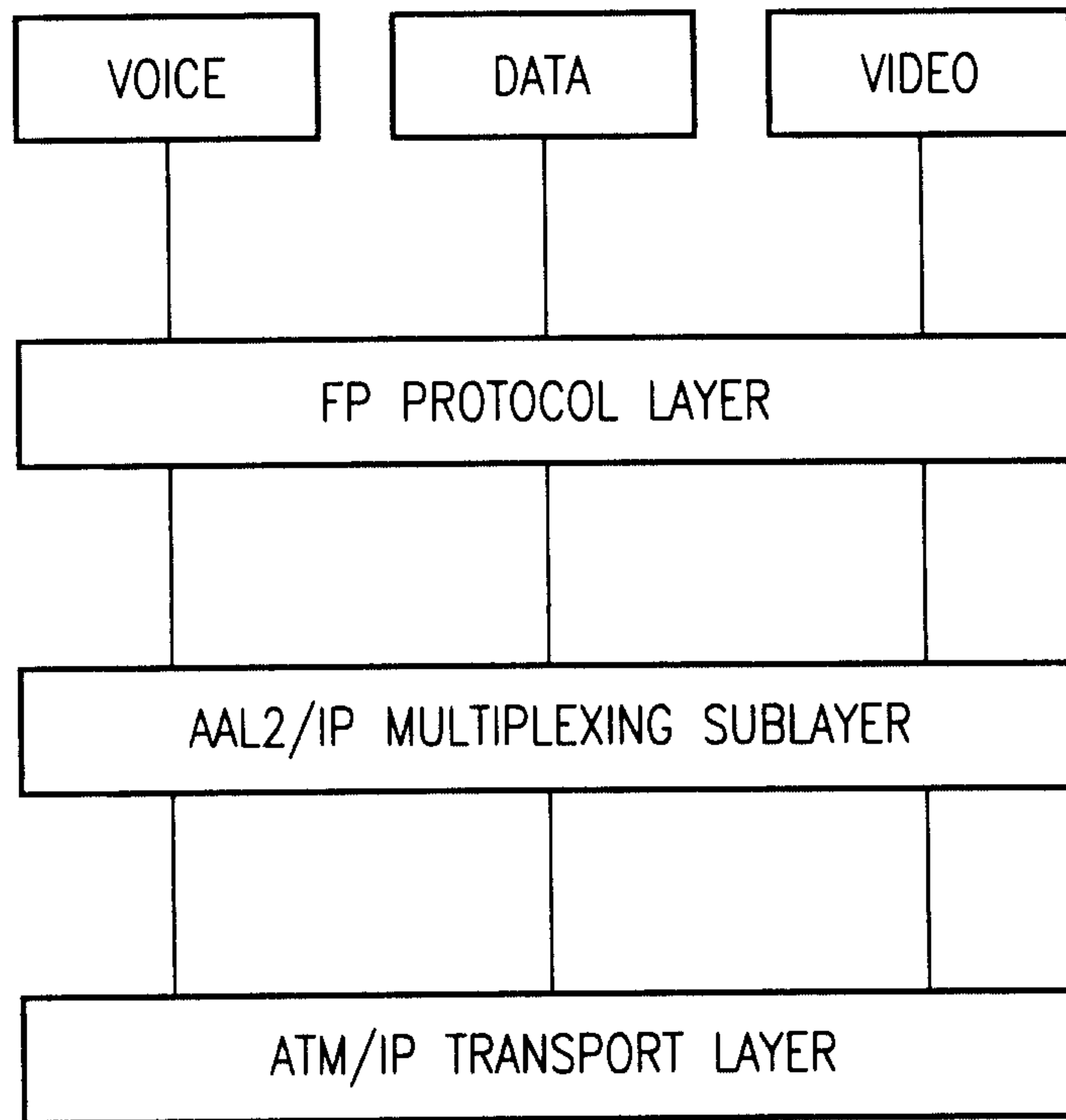

FIG. 7

