



(86) Date de dépôt PCT/PCT Filing Date: 2008/10/31
 (87) Date publication PCT/PCT Publication Date: 2009/05/07
 (85) Entrée phase nationale/National Entry: 2010/01/14
 (86) N° demande PCT/PCT Application No.: US 2008/082157
 (87) N° publication PCT/PCT Publication No.: 2009/059252
 (30) Priorité/Priority: 2007/10/31 (US11/933,264)

(51) Cl.Int./Int.Cl. *H04L 5/00* (2006.01)
 (71) Demandeur/Applicant:
 QUALCOMM INCORPORATED, US
 (72) Inventeurs/Inventors:
 LING, FUYUN, US;
 CHARI, MURALI RAMASWAMY, US;
 MANTRAVADI, ASHOK, US;
 KRISHNAMOORTHY, RAGHURAMAN, US
 (74) Agent: SMART & BIGGAR

(54) Titre : MULTIPLEXAGE ET TRANSMISSION DE FLUX DE DONNEES MULTIPLES DANS UN SYSTEME DE COMMUNICATION SANS FIL A ONDES PORTEUSES MULTIPLES
 (54) Title: MULTIPLEXING AND TRANSMISSION OF MULTIPLE DATA STREAMS IN A WIRELESS MULTI-CARRIER COMMUNICATION SYSTEM

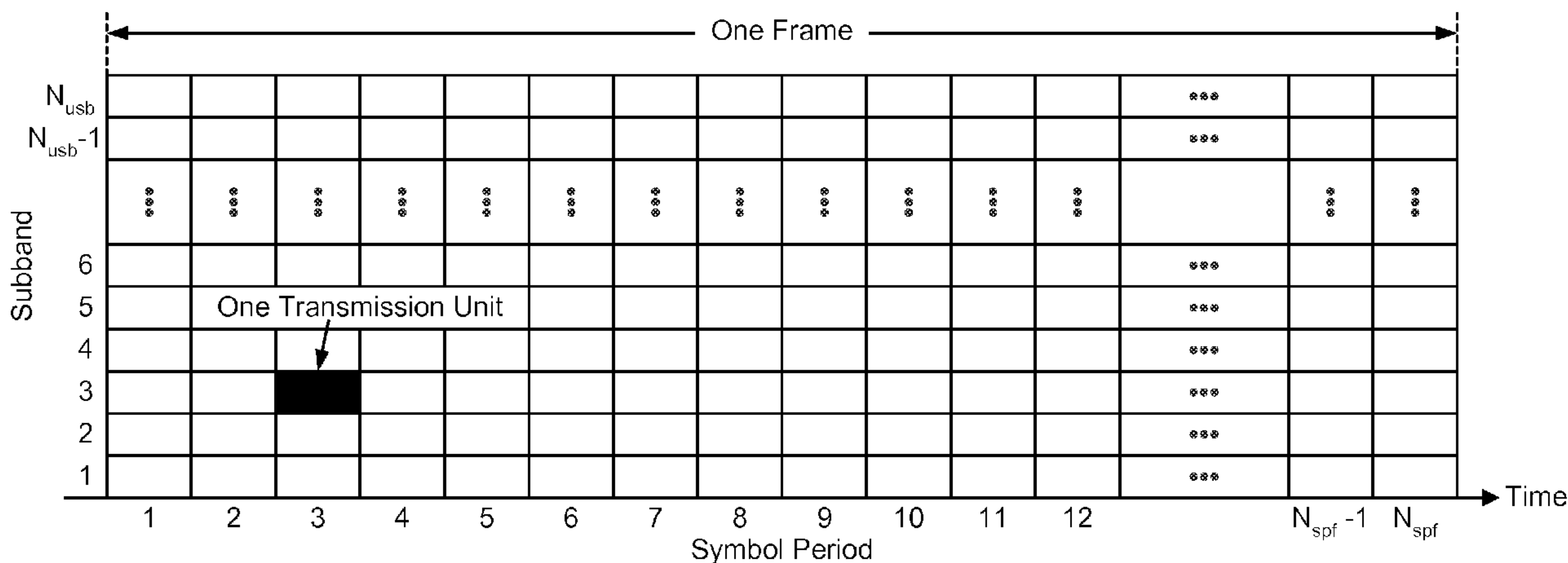

FIG. 4

(57) **Abrégé/Abstract:**

Techniques for multiplexing and transmitting multiple data streams are described. Transmission of the multiple data streams occurs in 'super-frames'. Each super-frame has a predetermined time duration and is further divided into multiple (e.g., four) frames. Each data block for each data stream is outer encoded to generate a corresponding code block. Each code block is partitioned into multiple subblocks, and each data packet in each code block is inner encoded and modulated to generate modulation symbols for the packet. The multiple subblocks for each code block are transmitted in the multiple frames of the same super-frame, one subblock per frame. Each data stream is allocated a number of transmission units in each super-frame and is assigned specific transmission units to achieve efficient packing. A wireless device can select and receive individual data streams.

(12) INTERNATIONAL APPLICATION PUBLISHED UNDER THE PATENT COOPERATION TREATY (PCT)

(19) World Intellectual Property Organization
International Bureau(43) International Publication Date
7 May 2009 (07.05.2009)

PCT

(10) International Publication Number
WO 2009/059252 A3(51) International Patent Classification:
H04L 5/00 (2006.01)

(21) International Application Number:

PCT/US2008/082157

(22) International Filing Date: 31 October 2008 (31.10.2008)

(25) Filing Language: English

(26) Publication Language: English

(30) Priority Data:

11/933,264 31 October 2007 (31.10.2007) US

(71) Applicant (for all designated States except US): **QUALCOMM Incorporated** [US/US]; ATTN: International IP Administration, 5775 Morehouse Drive, San Diego, California 92121-1714 (US).

(72) Inventors; and

(75) Inventors/Applicants (for US only): **LING, Fuyun** [US/US]; 5775 Morehouse Drive, San Diego, California 92121-1714 (US). **CHARI, Murali Ramaswamy** [US/US]; 5775 Morehouse Drive, San Diego, California 92121-1714 (US). **MANTRAVADI, Ashok** [IN/US]; 5775 Morehouse Drive, San Diego, California 92121-1714 (US). **KRISHNAMOORTHY, Raghuraman** [IN/US]; 5775 Morehouse Drive, San Diego, California 92121-1714 (US).(74) Agent: **BRADEN, Stanton C.**; ATTN: International IP Administration, 5775 Morehouse Drive, San Diego, California 92121-1714 (US).

(81) Designated States (unless otherwise indicated, for every kind of national protection available): AE, AG, AL, AM, AO, AT, AU, AZ, BA, BB, BG, BH, BR, BW, BY, BZ, CA, CH, CN, CO, CR, CU, CZ, DE, DK, DM, DO, DZ, EC, EE, EG, ES, FI, GB, GD, GE, GH, GM, GT, HN, HR, HU, ID, IL, IN, IS, JP, KE, KG, KM, KN, KP, KR, KZ, LA, LC, LK, LR, LS, LT, LU, LY, MA, MD, ME, MG, MK, MN, MW, MX, MY, MZ, NA, NG, NI, NO, NZ, OM, PG, PH, PL, PT, RO, RS, RU, SC, SD, SE, SG, SK, SL, SM, ST, SV, SY, TJ, TM, TN, TR, TT, TZ, UA, UG, US, UZ, VC, VN, ZA, ZM, ZW.

(84) Designated States (unless otherwise indicated, for every kind of regional protection available): ARIPO (BW, GH, GM, KE, LS, MW, MZ, NA, SD, SL, SZ, TZ, UG, ZM, ZW), Eurasian (AM, AZ, BY, KG, KZ, MD, RU, TJ, TM), European (AT, BE, BG, CH, CY, CZ, DE, DK, EE, ES, FI, FR, GB, GR, HR, HU, IE, IS, IT, LT, LU, LV, MC, MT, NL, NO, PL, PT, RO, SE, SI, SK, TR), OAPI (BF, BJ, CF, CG, CI, CM, GA, GN, GQ, GW, ML, MR, NE, SN, TD, TG).

Declarations under Rule 4.17:

- as to applicant's entitlement to apply for and be granted a patent (Rule 4.17(ii))
- as to the applicant's entitlement to claim the priority of the earlier application (Rule 4.17(iii))

Published:

- with international search report

[Continued on next page]

(54) Title: MULTIPLEXING AND TRANSMISSION OF MULTIPLE DATA STREAMS IN A WIRELESS MULTI-CARRIER COMMUNICATION SYSTEM

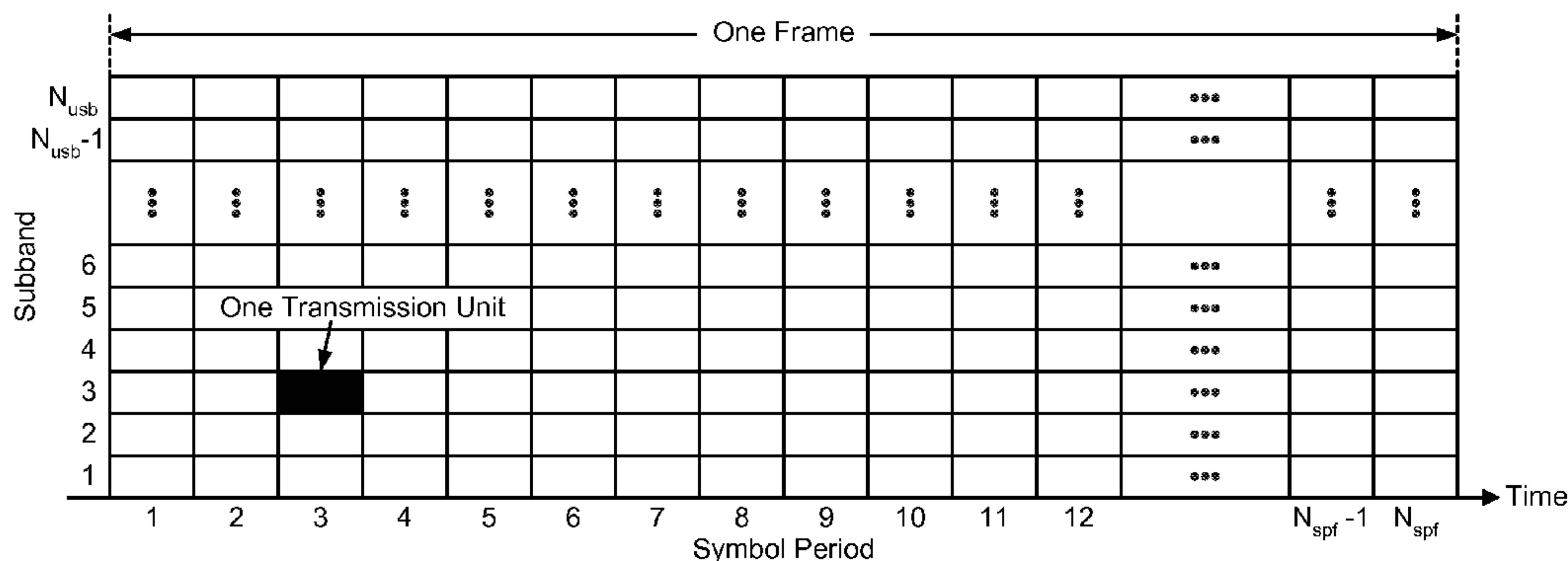

FIG. 4

(57) **Abstract:** Techniques for multiplexing and transmitting multiple data streams are described. Transmission of the multiple data streams occurs in 'super-frames'. Each super-frame has a predetermined time duration and is further divided into multiple (e.g., four) frames. Each data block for each data stream is outer encoded to generate a corresponding code block. Each code block is partitioned into multiple subblocks, and each data packet in each code block is inner encoded and modulated to generate modulation symbols for the packet. The multiple subblocks for each code block are transmitted in the multiple frames of the same super-frame, one subblock per frame. Each data stream is allocated a number of transmission units in each super-frame and is assigned specific transmission units to achieve efficient packing. A wireless device can select and receive individual data streams.

WO 2009/059252 A3

WO 2009/059252 A3



— *before the expiration of the time limit for amending the claims and to be republished in the event of receipt of amendments*

(88) Date of publication of the international search report:
9 July 2009

MULTIPLEXING AND TRANSMISSION OF MULTIPLE DATA STREAMS IN A WIRELESS MULTI-CARRIER COMMUNICATION SYSTEM

BACKGROUND

I. Field

[0001] The present disclosure relates generally to communication, and more specifically to techniques for multiplexing and transmitting multiple data streams in a wireless multi-carrier communication system.

II. Background

[0002] A multi-carrier communication system utilizes multiple carriers for data transmission. These multiple carriers may be provided by orthogonal frequency division multiplexing (OFDM), some other multi-carrier modulation techniques, or some other construct. OFDM effectively partitions the overall system bandwidth into multiple orthogonal subbands. These subbands are also referred to as tones, carriers, subcarriers, bins, and frequency channels. With OFDM, each subband is associated with a respective subcarrier that may be modulated with data.

[0003] A base station in a multi-carrier system may simultaneously transmit multiple data streams for broadcast, multicast, and/or unicast services. A data stream is a stream of data that may be of independent reception interest to a wireless device. A broadcast transmission is sent to all wireless devices within a designated coverage area, a multicast transmission is sent to a group of wireless devices, and a unicast transmission is sent to a specific wireless device. For example, a base station may broadcast a number of data streams for multimedia (e.g., television) programs via a terrestrial radio link for reception by wireless devices. This system may employ a conventional multiplexing and transmission scheme such as, for example, Digital Video Broadcasting-Terrestrial (DVB-T) or Integrated Services Digital Broadcasting-Terrestrial (ISDB-T). Such a scheme would first multiplex all of the data streams to be transmitted onto a single high-rate composite stream and then process (e.g., encode, modulate, and up-convert) the composite stream to generate a modulated signal for broadcast via the radio link.

[0004] A wireless device within the coverage area of the base station may be interested in receiving only one or few specific data streams among the multiple data streams carried by the composite stream. The wireless device would need to process (e.g., down-convert, demodulate, and decode) a received signal to obtain a high-rate decoded data stream and then demultiplex this stream to obtain the one or few specific data streams of interest. This type of processing may not be a problem for receiver units intended to be powered on all the time, such as those used in homes. However, many wireless devices are portable and powered by internal batteries. Continuous demodulation and decoding of the high-rate composite stream to recover just one or few data streams of interest consumes significant amounts of power. This can greatly shorten the “ON” time for the wireless devices, which is undesirable.

[0005] There is therefore a need in the art for techniques to transmit multiple data streams in a multi-carrier system such that they can be received by wireless devices, with minimal power consumption. Furthermore, there is a need to efficiently transmit data streams within OFDM systems with various amounts of subbands (i.e., FFT sizes), thereby providing flexibility for a wide range of radio frequencies and network deployments

SUMMARY

[0006] Techniques for multiplexing and transmitting multiple data streams in a manner to facilitate power-efficient and robust reception of individual data streams by wireless devices are described herein. Each data stream is processed separately based on a coding and modulation scheme (e.g., an outer code, an inner code, and a modulation scheme) selected for that stream to generate a corresponding data symbol stream. This allows the data streams to be individually recovered by the wireless devices. Each data stream is also allocated certain amount of resources for transmission of that stream. The allocated resources are given in “transmission units” on a time-frequency plane, where each transmission unit corresponds to one subband in one symbol period and may be used to transmit one data symbol. The data symbols for each data stream are mapped directly onto the transmission units allocated to the stream. This allows the wireless devices to recover each data stream independently, without having to process the other data streams being transmitted simultaneously.

[0007] In an aspect, transmission of the multiple data streams occurs in “super-frames”, with each super-frame having predetermined time duration (e.g., on the order

of a second or few seconds). Each super-frame is further divided into multiple (e.g., two, four, or some other number of) frames. For each data stream, each data block is processed (e.g., outer encoded) to generate a corresponding code block. Each code block is partitioned into multiple subblocks, and each subblock is further processed (e.g., inner encoded and modulated) to generate a corresponding subblock of modulation symbols. Each code block is transmitted in one super-frame, and the multiple subblocks for the code block are transmitted in the multiple frames of the super-frame, one subblock per frame. The partitioning of each code block into multiple subblocks, the transmission of these subblocks over multiple frames, and the use of block coding across the subblocks of the code block provide robust reception performance in slowly time-varying fading channels.

[0008] Each data stream may be “allocated” a variable number of transmission units in each super-frame depending on the stream’s payload in the super-frame, the availability of transmission units in the super-frame, and possibly other factors. Each data stream is also “assigned” specific transmission units within each super-frame using an assignment scheme that attempts to (1) pack the transmission units for all data streams as efficiently as possible, (2) reduce the transmission time for each data stream, (3) provide adequate time-diversity, and (4) minimize the amount of signaling to indicate the specific transmission units assigned to each data stream. Overhead signaling for various parameters of the data streams (e.g., the coding and modulation scheme used for each data stream, the specific transmission units assigned to each data stream, and so on) may be transmitted prior to each super-frame and may also be embedded within the data payload of each data stream. This allows a wireless device to determine the time-frequency location of each desired data stream in the upcoming super-frame. The wireless device may power on only when the desired data stream is transmitted, using the embedded overhead signaling, and thereby minimize power consumption.

[0009] In addition, aspects of the present disclosure are capable of operation using FFT sizes of, for example, 1K, 2K and 8K to complement the existing 4K FFT size. Different FFT sizes could be used in different RF frequency bands, in order to support different cell sizes & Doppler frequency requirements. It is noted, however, that the aforementioned FFT sizes are merely illustrative examples of various OFDM systems, and the present disclosure is not limited to only 1K, 2K, 4K and 8K FFT sizes. It is noted, however, that the aforementioned FFT sizes are merely illustrative examples of

various OFDM systems, and the present disclosure is not limited to only 1K, 2K, 4K and 8K FFT sizes.

[0010] Various aspects of the disclosure are described in further detail below.

BRIEF DESCRIPTION OF THE DRAWINGS

[0011] The features and nature of the present disclosure will become more apparent from the detailed description set forth below when taken in conjunction with the drawings in which like reference characters identify correspondingly throughout and wherein:

[0012] FIG. 1 shows a wireless multi-carrier system;

[0013] FIG. 2 shows an exemplary super-frame structure;

[0014] FIGS. 3A and 3B illustrate transmission of one data block and multiple data blocks, respectively, on a physical layer channel (PLC) in a super-frame;

[0015] FIG. 4 shows a frame structure in a time-frequency plane;

[0016] FIG. 5A shows a burst-TDM (time division multiplex) scheme;

[0017] FIG. 5B shows a cycled-TDM scheme;

[0018] FIG. 5C shows a burst-TDM/FDM (frequency division multiplex) scheme;

[0019] FIG. 6 shows an interlaced subband structure;

[0020] FIG. 7A shows assignment of slots to PLCs in rectangular patterns;

[0021] FIG. 7B shows assignment of slots to PLCs in “zigzag” segments;

[0022] FIG. 7C shows assignment of slots to two joint PLCs in rectangular patterns;

[0023] FIG. 8 illustrates coding of a data block with an outer code;

[0024] FIGS. 9A and 9B show assignment of slots for one data block using one subband group and a maximum allowable number of subband groups, respectively;

[0025] FIG. 9C shows assignment of slots for six data blocks;

[0026] FIGS. 9D and 9E show assignment of slots to two joint PLCs with rectangular patterns stacked horizontally and vertically, respectively;

[0027] FIG. 10 shows a process for broadcasting multiple data streams;

[0028] FIG. 11 shows a block diagram of a base station;

[0029] FIG. 12 shows a block diagram of a wireless device;

[0030] FIG. 13 shows a block diagram of a transmit (TX) data processor, a channelizer, and an OFDM modulator at the base station; and

[0031] FIG. 14 shows a block diagram of a data stream processor for one data stream.

DETAILED DESCRIPTION

[0032] The word “exemplary” is used herein to mean “serving as an example, instance, or illustration.” Any aspect or design described herein as “exemplary” is not necessarily to be construed as preferred or advantageous over other aspects or designs.

[0033] The multiplexing and transmission techniques described herein may be used for various wireless multi-carrier communication systems. These techniques may also be used for broadcast, multicast, and unicast services. For clarity, these techniques are described for an exemplary multi-carrier broadcast system.

[0034] **FIG. 1** shows a wireless multi-carrier broadcast system 100. System 100 includes a number of base stations 110 that are distributed throughout the system. A base station is generally a fixed station and may also be referred to as an access point, a transmitter, or some other terminology. Neighboring base stations may broadcast the same or different content. Wireless devices 120 are located throughout the coverage area of the system. A wireless device may be fixed or mobile and may also be referred to as a user terminal, a mobile station, user equipment, or some other terminology. A wireless device may also be a portable unit such as a cellular phone, a handheld device, a wireless module, a personal digital assistant (PDA), and so on.

[0035] Each base station 110 may broadcast multiple data streams simultaneously to wireless devices within its coverage area. These data streams may be for multimedia content such as video, audio, tele-text, data, video/audio clips, and so on. For example, a single multimedia (e.g., television) program may be sent in three separate data streams for video, audio, and data. A single multimedia program may also have multiple audio data streams, e.g., for different languages. For simplicity, each data stream is sent on a separate physical layer channel (PLC). There is thus a one-to-one relationship between data streams and PLCs. A PLC may also be called a data channel, a traffic channel, or some other terminology.

[0036] **FIG. 2** shows an exemplary super-frame structure that may be used for broadcast system 100. Data transmission occurs in units of super-frames 210. Each super-frame has a predetermined time duration, which may be selected based on various factors such as, for example, the desired statistical multiplexing for the data streams, the desired amount of time diversity, acquisition time for the data streams, buffer requirements for the wireless devices, and so on. A larger super-frame size provides more time diversity and better statistical multiplexing of the data streams being transmitted, so that less buffering may be required for individual data streams at the

base station. However, a larger super-frame size also results in a longer acquisition time for a new data stream (e.g., at power-on or when switching between data streams), requires larger buffers at the wireless devices, and also has longer decoding latency or delay. A super-frame size of approximately one second may provide good tradeoff between the various factors described above. However, other super-frame sizes (e.g., a quarter, a half, two, or four seconds) may also be used. Each super-frame is further divided into multiple equal-sized frames 220. For the aspect shown in FIG. 2, each super-frame is divided into four frames.

[0037] The data stream for each PLC is encoded and modulated based on a coding and modulation scheme selected for that PLC. In general, a coding and modulation scheme comprises all of the different types of encoding and modulation to be performed on a data stream. For example, a coding and modulation scheme may comprise a particular coding scheme and a particular modulation scheme. The coding scheme may comprise error detection coding (e.g., a cyclic redundancy check (CRC)), forward error correction coding, and so on, or a combination thereof. The coding scheme may also indicate a particular code rate of a base code. In an aspect that is described below, the data stream for each PLC is encoded with a concatenated code comprised of an outer coder and an inner code and is further modulated based on a modulation scheme. As used herein, a “mode” refers to a combination of an inner code rate and a modulation scheme.

[0038] FIG. 3A illustrates the transmission of a data block on a PLC in a super-frame. The data stream to be sent on the PLC is processed in data blocks. Each data block contains a particular number of information bits and is first encoded using an outer code to obtain a corresponding code block. Each code block is partitioned into four subblocks, and the bits in each subblock are further encoded using an inner code and then mapped to modulation symbols, based on the mode selected for the PLC. The four subblocks of modulation symbols are then transmitted in the four frames of one super-frame, one subblock per frame. The transmission of each code block over four frames provides time diversity and robust reception performance in a slowly time-varying fading channel.

[0039] FIG. 3B illustrates the transmission of multiple (N_{bl}) data blocks on a PLC in a super-frame. Each of the N_{bl} data blocks is encoded separately using the outer code to obtain a corresponding code block. Each code block is further partitioned into four subblocks, which are inner encoded and modulated based on the mode selected for the

PLC and then transmitted in the four frames of one super-frame. For each frame, N_{bl} subblocks for the N_{bl} code blocks are transmitted in a portion of the frame that has been allocated to the PLC.

[0040] Each data block may be encoded and modulated in various manners. An exemplary concatenated coding scheme is described below. To simplify the allocation and assignment of resources to the PLCs, each code block may be divided into four equal-sized subblocks that are then transmitted in the same portion or location of the four frames in one super-frame. In this case, the allocation of a super-frame to the PLCs is equivalent to the allocation of a frame to the PLCs. Hence, resources can be allocated to the PLCs once every super-frame.

[0041] Each PLC may be transmitted in a continuous or non-continuous manner, depending on the nature of the data stream being carried by that PLC. Thus, a PLC may or may not be transmitted in any given super-frame. For each super-frame, an “active” PLC is a PLC that is being transmitted in that super-frame. Each active PLC may carry one or multiple data blocks in the super-frame.

[0042] Referring back to FIG. 2, each super-frame 210 is preceded by a pilot and overhead section 230. In an aspect, section 230 includes (1) one or more pilot OFDM symbols used by the wireless devices for frame synchronization, frequency acquisition, timing acquisition, channel estimation, and so on, and (2) one or more overhead OFDM symbols used to carry overhead signaling information for the associated (e.g., immediately following) super-frame. The overhead information indicates, for example, the specific PLCs being transmitted in the associated super-frame, the specific portion of the super-frame used to send the data block(s) for each PLC, the outer code rate and mode used for each PLC, and so on. The overhead OFDM symbol(s) carries overhead signaling for all PLCs sent in the super-frame. The transmission of the pilot and overhead information in a time division multiplexed (TDM) manner allows the wireless devices to process this section with minimal ON time. In addition, overhead information pertaining to each PLC’s transmission in the next super-frame may be embedded in one of the PLC’s transmitted data blocks in the current super-frame. The embedded overhead information allows the wireless device to recover the PLC’s transmission in the next super-frame without having to check the overhead OFDM symbol(s) sent in that super-frame. Thus, the wireless devices may initially use the overhead OFDM symbols to determine the time-frequency location of each desired data stream, and may subsequently power on only during the time that the desired data

stream is transmitted using the embedded overhead signaling. These signaling techniques may provide significant savings in power consumption and allow the wireless devices to receive content using standard batteries. Since the outer code rate and mode used for each PLC typically do not vary on a super-frame basis, the outer code rate and mode may be sent on a separate control channel and do need not be sent in every super-frame.

[0043] FIG. 2 shows a specific super-frame structure. In general, a super-frame may be defined to be of any time duration and may be divided into any number of frames. Pilot and overhead information may also be sent in other manners different from the manner shown in FIG. 2. For example, overhead information may be sent on dedicated subbands using frequency division multiplexing (FDM).

[0044] FIG. 4 shows the structure of one frame on a time-frequency plane. The horizontal axis represents time, and the vertical axis represents frequency. Each frame has a predetermined time duration, which is given in units of OFDM symbol periods (or simply, symbol periods). Each OFDM symbol period is the time duration to transmit one OFDM symbol (described below). The specific number of symbol periods per frame (N_{spf}) is determined by the frame duration and the symbol period duration, which in turn is determined by various parameters such as the overall system bandwidth, the total number of subbands (N_{tsb}), and the cyclic prefix length (described below). In an aspect, each frame has a duration of 297 symbol periods (or $N_{\text{spf}} = 297$). It is noted that the time unit for a frame consists of MAC Time Units at the MAC (or allocation) layer, and OFDM symbol periods at the PHY layer. Thus, “symbol period” in the rest of the description can either refer to the MAC time unit in the context of PLC allocation or OFDM symbol period in the context of subband allocation. As a result, the term “symbol period” should be interpreted based on the context.

[0045] Each frame also covers the N_{tsb} total subbands, which are given indices of 1 through N_{tsb} .

[0046] With OFDM, one modulation symbol may be sent on each subband in each symbol period, i.e., each transmission unit. Of the N_{tsb} total subbands, N_{dsb} subbands may be used for data transmission and are referred to as “data” subbands, N_{psb} subbands may be used for pilot and are referred to as “pilot” subbands, and the remaining N_{gsb} subbands may be used as “guard” subbands (i.e., no data or pilot transmission), where $N_{\text{tsb}} = N_{\text{dsb}} + N_{\text{psb}} + N_{\text{gsb}}$. The number of “usable” subbands is equal to the number of

data and pilot subbands, or $N_{usb} = N_{dsb} + N_{psb}$. In an aspect, broadcast system 100 utilizes an OFDM structure having 4096 total subbands ($N_{tsb} = 4096$), 3500 data subbands ($N_{dsb} = 3500$), 500 pilot subbands ($N_{psb} = 500$), and 96 guard subbands ($N_{gsb} = 96$). Other OFDM structures with different number of data, pilot, usable, and total subbands may also be used. In each OFDM symbol period, N_{dsb} data symbols may be sent on the N_{dsb} data subbands, N_{psb} pilot symbols may be sent on the N_{psb} pilot subbands, and N_{gsb} guard symbols are sent on the N_{gsb} guard subbands. As used herein, a “data symbol” is a modulation symbol for data, a “pilot symbol” is a modulation symbol for pilot, and a “guard symbol” is a signal value of zero. The pilot symbols are known *a priori* by the wireless devices. The N_{dsb} data symbols in each OFDM symbol may be for one or multiple PLCs.

[0047] In general, any number of PLCs may be transmitted in each super-frame. For a given super-frame, each active PLC may carry one or multiple data blocks. In one aspect, a specific mode and a specific outer code rate is used for each active PLC, and all data blocks for the PLC are encoded and modulated in accordance with this outer code rate and mode to generate corresponding code blocks and subblocks of modulation symbols, respectively. In another aspect, each data block may be encoded and modulated in accordance with a specific outer code rate and mode to generate a corresponding code block and subblocks of modulation symbols, respectively. In any case, each code block contains a specific number of data symbols, which is determined by the mode used for that code block.

[0048] Each active PLC in a given super-frame is allocated a specific amount of resources to transmit that PLC in the super-frame. The amount of resources allocated to each active PLC is dependent on (1) the number of code blocks to be sent on the PLC in the super-frame, (2) the number of data symbols in each code block, and (3) the number of code blocks, along with the number of data symbols per code block, to be sent on other PLCs. Resources may be allocated in various manners. Two exemplary allocation schemes are described below.

[0049] FIG. 5A shows a burst-TDM allocation scheme. For this scheme, each active PLC is allocated all N_{dsb} data subbands in one or more OFDM symbol periods. For the example shown in FIG. 5A, PLC 1 is allocated all data subbands in symbol periods 1 through 3, PLC 2 is allocated all data subbands in symbol periods 4 and 5, and PLC 3 is allocated all data subbands in symbol periods 6 through 9. For this scheme,

each OFDM symbol contains data symbols for only one PLC. The bursts of OFDM symbols for different PLCs are time division multiplexed within a frame.

[0050] If consecutive OFDM symbols are assigned to each active PLC, then the burst-TDM can minimize the transmission time for the PLCs. However, the short transmission time for each PLC also results in less time diversity. Since an entire OFDM symbol is allocated to one PLC, the granularity of the resource allocation (i.e., the smallest unit that may be allocated to a PLC) for each frame is one OFDM symbol. The number of information bits that may be sent in one OFDM symbol is dependent on the mode used to process the information bits. For the burst-TDM scheme, the granularity of the allocation is then dependent on mode. The granularity is larger for higher order modes that are capable of carrying more information bits per data symbol. In general, a larger granularity adversely impacts “packing” efficiency, which refers to the percentage of the frame that is actually used to carry data. If an active PLC does not require the data-carrying capacity of an entire OFDM symbol, then the excess capacity is wasted and reduces packing efficiency.

[0051] FIG. 5B shows a cycled-TDM allocation scheme. For this scheme, the active PLCs in the super-frame are arranged into L groups, where $L > 1$. A frame is also divided into L sections, and each PLC group is assigned to a respective section of the frame. For each group, the PLCs in the group are cycled through, and each PLC is allocated all N_{dsb} data subbands in one or more OFDM symbol periods in the assigned section. For the example shown in FIG. 5B, PLC 1 is allocated all data subbands in symbol period 1, PLC 2 is allocated all data subbands in symbol period 2, PLC 3 is allocated all data subbands in symbol period 3, PLC 1 is allocated all data subbands in symbol period 4, and so on. Compared to burst-TDM, the cycled-TDM scheme may provide more time diversity, reduce receiver buffering requirements and peak decoding rate, but increase the receiver on-time to receive a given PLC.

[0052] FIG. 5C shows a burst-TDM/FDM allocation scheme. For this scheme, each active PLC is allocated one or more data subbands in one or more symbol periods. For the example shown in FIG. 5C, PLC 1 is allocated data subbands 1 through 3 in symbol periods 1 through 8, PLC 2 is allocated data subbands 4 and 5 in symbol periods 1 through 8, and PLC 3 is allocated data subbands 6 through 9 in symbol periods 1 through 8. For the burst-TDM/FDM scheme, each OFDM symbol may contain data symbols for multiple PLCs. The bursts of data symbols for different PLCs are time and frequency division multiplexed within a frame.

[0053] Since the payload of each PLC may be distributed over time as well as frequency, the burst-TDM/FDM scheme may increase the transmission time for the PLC. However, this also provides more time diversity. The transmission time for each PLC may be reduced by allocating more subbands to the PLC. For the burst-TDM/FDM scheme, the granularity of the resource allocation may be selected based on a tradeoff between packing efficiency and overhead signaling. In general, smaller granularity results in better packing efficiency but also requires more overhead signaling to indicate the resources allocated to each PLC. The inverse is generally true with larger granularity. The description below assumes the use of the burst-TDM/FDM scheme.

[0054] In an aspect, the N_{usb} usable subbands are divided into N_{gr} groups of usable subbands. One of the N_{gr} groups may then contain the pilot subbands. For the remaining groups, the number of data subbands in one group determines the granularity of the resource allocation. The N_{usb} usable subbands may be arranged into the N_{gr} groups in various manners. In one subband grouping scheme, each group contains N_{spg} consecutive usable subbands, where $N_{usb} = N_{gr} \cdot N_{spg}$. In another subband grouping scheme, each group contains N_{spg} usable subbands that are pseudo-randomly distributed across the N_{usb} usable subbands. In yet another subband grouping scheme, each group contains N_{spg} usable subbands that are uniformly spaced across the N_{usb} usable subbands.

[0055] FIG. 6 shows an interlaced subband structure 600 that may be used for the burst-TDM/FDM scheme. The N_{usb} usable subbands are arranged into N_{gr} disjoint groups, which are labeled as subband groups 1 through N_{gr} . The N_{gr} subband groups are disjoint in that each of the N_{usb} usable subbands belongs to only one group. Each subband group contains N_{spg} usable subbands that are uniformly distributed across the N_{usb} total usable subbands such that consecutive subbands in the group are spaced apart by N_{sp} subbands. In an aspect, the 4000 usable subbands ($N_{usb} = 4000$) are arranged into eight groups ($N_{gr} = 8$), each group contains 500 usable subbands ($N_{spg} = 500$), and the usable subbands for each group are spaced apart by eight subbands ($N_{sp} = 8$). The usable subbands in each group are thus interlaced with the usable subbands in the other $N_{gr} - 1$ groups. Each subband group is also referred to as an “interlace”.

[0056] The interlaced subband structure provides various advantages. First, better frequency diversity is achieved since each group includes usable subbands from across the entire system bandwidth. Second, a wireless device may recover data symbols sent on each subband group by performing a “partial” (e.g., 512-point) fast Fourier transform (FFT) instead of a full (e.g., 4096-point) FFT, which may reduce the power consumed by the wireless device. Techniques for performing a partial FFT are described in commonly assigned U.S. Patent Application Serial No. 10/775,719, entitled “Subband-Based Demodulator for an OFDM-based Communication System,” filed February 9, 2004. The following description assumes the use of the interlaced subband structure shown in FIG. 6.

[0057] Each PLC may be allocated resources on a super-frame by super-frame basis. The amount of resources to allocate to each PLC in each super-frame is dependent on the payload of the PLC for that super-frame. A PLC may carry a fixed-rate data stream or a variable-rate data stream. In an aspect, the same mode is used for each PLC even if the data rate of the data stream carried by that PLC changes. This ensures that the coverage area for the data stream remains approximately constant regardless of data rate, so that reception performance is not dependent on data rate. The variable rate nature of a data stream is handled by varying the amount of resources allocated to the PLC in each super-frame.

[0058] Each active PLC is allocated resources from the time-frequency plane, as shown in FIG. 4. The allocated resources for each active PLC may be given in units of “transmission slots” (or simply, “slots”). A slot corresponds to one group of (e.g., 500) data subbands or, equivalently, one group of modulation symbols in one symbol period. N_{gr} slots are available in each symbol period and may be assigned slot indices 1 through N_{gr} . Each slot index may be mapped to one subband group in each symbol period based on a slot-to-interlace mapping scheme. One or more slot indices may be used for an FDM pilot, and the remaining slot indices may be used for the PLCs. The slot-to-interlace mapping may be such that the subband groups (or interlaces) used for the FDM pilot have varying distances to the subband groups used for each slot index. This allows all slot indices used for the PLCs to achieve similar performance.

[0059] Although forgoing aspects have assumed an FFT size of 4K, it is noted that aspects of the present disclosure are capable of multiplexing and transmitting multiple data streams in OFDM systems of various FFT sizes. For an OFDM system with a 4K

FFT size, a group of 500 modulation symbols, forming a slot, is mapped into one interlace.

[0060] It is noted, however, that a slot is fixed across different FFT sizes. Moreover, the size of an interlace is $1/8^{\text{th}}$ the number of active subbands, and a slot gets mapped into either a fractional or a multiple (including one) interlaces based on the FFT size. The interlace(s) assigned to a slot may reside in multiple OFDM symbol periods. For example, for a 2K FFT size, a slot (i.e., 500 modulation symbols) maps into 2 interlaces over 2 consecutive 2K OFDM symbols. Similarly, for a 1K FFT size, a slot maps into 4 interlaces over 4 consecutive 1K OFDM symbols. Further, as an example, the number of useable subbands for 1K, 2K, 4K and 8K FFT sizes, respectively, would be 1000, 2000, 4000 and 8000, since said useable subbands would not include, for example, guard subbands. That is, an FFT size of 1K contains 1024 subbands, where 24 of the subbands may be used as guard subbands, for example. The number of guard subbands may, for example, increase proportionally with FFT size.

[0061] It follows that for an 8K FFT size, a slot maps into half of an interlace over half of an 8K OFDM symbol. It is noted that, regardless of the FFT size, a MAC time unit comprises 8 slots. The following table shows the relationships between FFT sizes of 1K, 2K, 4K and 8K and their respective number of OFDM symbols per MAC time unit, number of subbands per interlace and number of interlaces per slot:

FFT Size	Number of OFDM Symbols per MAC time unit	Number of subbands per Interlace	Number of Interlaces per Slot
1024	4	125	4
2048	2	250	2
4096	1	500	1
8192	$\frac{1}{2}$	1000	$\frac{1}{2}$

MAC time units vs OFDM symbols; Slots vs Interlaces

[0062] Thus, relying on the relationships between MAC time units and OFDM symbols and the relationships between slots and interlaces it follows that aspects of the present disclosure are capable of MAC layer multiplexing over MAC time units and slots, regardless of the FFT size of the OFDM system. The physical layer maps MAC time units and Slots to OFDM symbols and interlaces, respectively, for various FFT sizes.

[0063] Although the examples above refer only to 1K, 2K, 4K and 8K FFT sizes, the present disclosure is not limited to these particular FFT sizes and other FFT sizes could be implemented without departing from the scope of the claimed invention.

[0064] Each active PLC is allocated at least one slot in a super-frame. Each active PLC is also assigned specific slot(s) in the super-frame. The “allocation” process provides each active PLC with the amount or quantity of resources, whereas the “assignment” process provides each active PLC with the specific resources within the super-frame. For clarity, allocation and assignment may be viewed as separate processes. In practice, allocation and assignment are typically performed jointly since allocation may be affected by assignment, and vice versa. In any case, the assignment may be performed in a manner to achieve the following goals:

1. Minimize the transmission time for each PLC to reduce ON time and power consumption by the wireless devices to recover the PLC;
2. Maximize time diversity for each PLC to provide robust reception performance;
3. Constrain each PLC to be within a specified maximum bit rate; and
4. Minimize buffering requirements for the wireless devices.

The maximum bit rate indicates the maximum number of information bits that may be transmitted in each OFDM symbol for one PLC. The maximum bit rate is typically set by the decoding and buffering capabilities of the wireless devices. Constraining each PLC to be within the maximum bit rate ensures that the PLC can be recovered by wireless devices having the prescribed decoding and buffering capabilities.

[0065] Some of the goals listed above conflict with one another. For example, goals 1 and 2 conflict, and goals 1 and 4 conflict. A resource allocation/assignment scheme attempts to achieve a balance between conflicting goals and may allow for flexibility in the setting of priority.

[0066] Each active PLC in a super-frame is allocated a certain number of slots based on the payload of the PLC. Different PLCs may be allocated different numbers of

slots. The specific slots to assign to each active PLC may be determined in various manners. Some exemplary slot assignment schemes are described below.

[0067] FIG. 7A shows assignment of slots to PLCs in rectangular patterns, in accordance with a first slot assignment scheme. Each active PLC is assigned slots arranged in a two-dimensional (2-D) rectangular pattern. The size of the rectangular pattern is determined by the number of slots allocated to the PLC. The vertical dimension (or height) of the rectangular pattern is determined by various factors such as the maximum bit rate. The horizontal dimension (or width) of the rectangular pattern is determined by the number of allocated slots and the vertical dimension.

[0068] To minimize transmission time, an active PLC may be assigned as many subband groups as possible while conforming to the maximum bit rate. The maximum number of information bits that may be sent in one OFDM symbol may be encoded and modulated with different modes to obtain different numbers of data symbols, which then require different numbers of data subbands for transmission. The maximum number of data subbands that may be used for each PLC may thus be dependent on the mode used for the PLC.

[0069] In an aspect, the rectangular pattern for each active PLC includes contiguous subband groups (in indices) and contiguous symbol periods. This type of assignment reduces the amount of overhead signaling needed to specify the rectangular pattern and further makes the slot assignments for the PLCs more compact, which then simplifies the packing of the PLCs within a frame. The frequency dimension of the rectangular pattern may be specified by the starting subband group and the total number of subband groups for the rectangular pattern. The time dimension of the rectangular pattern may be specified by the starting symbol period and the total number of symbol periods for the rectangular pattern. The rectangular pattern for each PLC may thus be specified with four parameters.

[0070] For the example shown in FIG. 7A, PLC 1 is assigned 8 slots in a 2×4 rectangular pattern 712, PLC 2 is assigned 12 slots in a 4×3 rectangular pattern 714, and PLC 3 is assigned 6 slots in a 1×6 rectangular pattern 716. The remaining slots in the frame may be assigned to other active PLCs. As shown in FIG. 7A, different rectangular patterns may be used for different active PLCs. To improve packing efficiency, the active PLCs may be assigned slots in a frame, one PLC at a time and in a sequential order determined by the number of slots allocated to each PLC. For example, slots in the frame may be assigned first to the PLC with the largest number of allocated

slots, then to the PLC with the next largest number of allocated slots, and so on, and then finally to the PLC with the smallest number of allocated slots. The slots may also be assigned based on other factors such as, for example, the priority of the PLCs, the relationship among the PLCs, and so on.

[0071] FIG. 7B shows assignment of slots to PLCs in “sinusoidal” or “zigzag” segments, in accordance with a second slot assignment scheme. For this scheme, a frame is divided into N_{st} “strips”. Each strip covers at least one subband group and further spans a contiguous number of symbol periods, up to the maximum number of symbol periods in a frame. The N_{st} strips may include the same or different numbers of subband groups. Each of the active PLCs is mapped to one of the N_{st} strips based on various factors. For example, to minimize transmission time, each active PLC may be mapped to the strip with the most number of subband groups allowed for that PLC.

[0072] The active PLCs for each strip are assigned slots in the strip. The slots may be assigned to the PLCs in a specific order, e.g., using a vertical zigzag pattern. This zigzag pattern selects slots from low to high subband group indices, for one symbol period at a time, and from symbol periods 1 to N_{spf} . For the example shown in FIG. 7B, strip 1 includes subband groups 1 through 3. PLC 1 is assigned a segment 732 containing 10 slots from subband group 1 in symbol period 1 through subband group 1 in symbol period 4. PLC 2 is assigned a segment 734 containing 4 slots from subband group 2 in symbol period 4 through subband group 2 in symbol period 5. PLC 3 is assigned a segment 736 containing 6 slots from subband group 3 in symbol period 5 through subband group 2 in symbol period 7. The remaining slots in strip 1 may be assigned to other active PLCs mapped to this strip.

[0073] The second slot assignment scheme effectively maps all of the slots in a two-dimensional (2-D) strip onto a one-dimensional (1-D) strip and then performs 2-D slot assignment using one dimension. Each active PLC is assigned a segment within the strip. The assigned segment may be specified by two parameters: the start of the segment (which may be given by the starting subband and symbol period) and the length of the segment. An additional parameter is used to indicate the specific strip to which the PLC is mapped. In general, the segment assigned to each active PLC may include any number of slots. However, less overhead signaling is required to identify the assigned segments if the segment sizes are constrained to be in multiple (e.g., 2 or 4) slots.

[0074] The second slot assignment scheme can assign slots to active PLCs in a simple manner. Also, tight packing may be achieved for each strip since the slots within the strip may be consecutively assigned to the PLCs. The vertical dimensions of the N_{st} strips may be defined to match the profile of all active PLCs in the super-frame so that (1) as many PLCs as possible are sent using the largest number of data subbands allowed for the PLCs and (2) the N_{st} strips are packed as fully as possible.

[0075] FIGS. 7A and 7B show two exemplary slot assignment schemes. These schemes facilitate efficient packing of PLCs in each frame. These schemes also reduce the amount of overhead signaling needed to indicate the specific slots assigned to each active PLC. Other slot assignment schemes may also be used, and this is within the scope of the disclosure. For example, a slot assignment scheme may partition a frame into strips, the active PLCs for the frame may be mapped to the available strips, and the PLCs for each strip may be assigned rectangular patterns within the strip. The strips may have different heights (i.e., different numbers of subband groups). The rectangular patterns assigned to the PLCs for each strip may have the same height as that of the strip but may have different widths (i.e., different number of symbol periods) determined by the number of slots allocated to the PLCs.

[0076] For simplicity, FIGS. 7A and 7B show the assignment of slots to individual PLCs. For some services, multiple PLCs may be jointly decoded by wireless devices and are referred to as “joint” PLCs. This may be the case, for example, if multiple PLCs are used for the video and audio components of a single multimedia program and are jointly decoded to recover the program. The joint PLCs may be allocated the same or different number of slots in each super-frame, depending on their payloads. To minimize the ON time, the joint PLCs may be assigned slots in consecutive symbol periods so that the wireless devices do not need to “wake up” multiple times within a frame to receive these PLCs.

[0077] FIG. 7C shows assignment of slots to two joint PLCs 1 and 2 based on the first slot assignment scheme. In a first aspect, the joint PLCs are assigned slots in rectangular patterns that are stacked horizontally or side-by-side. For the example shown in FIG. 7C, PLC 1 is allocated 8 slots in a 2×4 rectangular pattern 752, and PLC 2 is allocated 6 slots in a 2×3 rectangular pattern 754, which is located directly to the right of pattern 752. This aspect allows each PLC to be decoded as soon as possible, which may reduce buffering requirements at the wireless devices.

[0078] In a second aspect, the joint PLCs are assigned slots in rectangular patterns that are stacked vertically. For the example shown in FIG. 7C, PLC 3 is allocated 8 slots in a 2×4 rectangular pattern 762, and PLC 4 is allocated 6 slots in a 2×3 rectangular pattern 764, which is located directly above pattern 762. The total number of subband groups used for the joint PLCs may be such that these joint PLCs collectively conform to the maximum bit rate. For the second aspect, the wireless devices may store the received data symbols for the joint PLCs in separate buffers until they are ready for decoding. The second aspect may reduce the ON time for the joint PLCs relative to the first aspect.

[0079] In general, any number of PLCs may be jointly decoded. The rectangular patterns for the joint PLCs may span the same or different numbers of subband groups, which may be constrained by the maximum bit rate. The rectangular patterns may also span the same or different numbers of symbol periods. The rectangular patterns for some sets of joint PLCs may be stacked horizontally while the rectangular patterns for other sets of joint PLCs may be stacked vertically.

[0080] Joint PLCs may also be assigned zigzag segments. In one aspect, the multiple PLCs to be jointly decoded are assigned consecutive segments in the same strip. In another aspect, the multiple PLCs are assigned segments in different strips, and the segments overlap in time as much as possible in order to reduce the ON time to recover these PLCs.

[0081] In general, each data stream may be encoded in various manners. In an aspect, each data stream is encoded with a concatenated code comprised of an outer code and an inner code. The outer code may be a block code such as a Reed-Solomon (RS) code or some other code. The inner code may be a Turbo code (e.g., a parallel concatenated convolutional code (PCCC) or a serially concatenated convolutional code (SCCC)), a convolutional code, a low-density parity-check (LDPC) code, or some other code.

[0082] FIG. 8 shows an exemplary outer coding scheme using a Reed-Solomon code. A data stream for a PLC is partitioned into data packets. In an aspect, each data packet contains a predetermined number (L) of information bits. As a specific example, each data packet may contain 976 information bits. Other packet sizes and formats may also be used. The data packets for the data stream are written into rows of a memory, one packet per row. After K data packets have been written into K rows, block coding is performed column-wise, one column at a time. In an aspect, each column contains K

bytes (one byte per row) and is encoded with an (N, K) Reed-Solomon code to generate a corresponding codeword that contains N bytes. The first K bytes of the codeword are data bytes (which are also called systematic bytes) and the last $N - K$ bytes are parity bytes (which may be used by a wireless device for error correction). The Reed-Solomon coding generates $N - K$ parity bytes for each codeword, which are written to rows $K + 1$ through N in the memory after the K rows of data. An RS block contains K rows of data and $N - K$ rows of parity. In an aspect, $N = 16$ and K is a configurable parameter, e.g., $K \in \{12, 14, 16\}$. The Reed-Solomon code is disabled when $K = N$. A CRC value, e.g., 16-bits in length, is then appended to each data packet (or row) of the RS block followed by the addition of (e.g., 8) zero (tail) bits to reset the inner encoder to a known state. The resulting longer (e.g., 1000 bits) packet is subsequently encoded by the inner code to generate a corresponding inner coded packet. A code block contains N outer coded packets for the N rows of the RS block, where each outer coded packet may be a data packet or a parity packet. The code block is divided into four subblocks, and each subblock contains four outer coded packets if $N = 16$.

[0083] In an aspect, each data stream may be transmitted with or without layered coding, where the term “coding” in this context refers to channel encoding rather than source encoding at a transmitter. A data stream may be comprised of two substreams, which are called a base stream and an enhancement stream. In one aspect, the base stream may carry information sent to all wireless devices within the coverage area of the base station. The enhancement stream may carry additional information sent to wireless devices observing better channel conditions. With layered coding, the base stream is encoded and modulated in accordance with a first mode to generate a first modulation symbol stream, and the enhancement stream is encoded and modulated in accordance with a second mode to generate a second modulation symbol stream. The first and second modes may be the same or different. The two modulation symbol streams are then combined to obtain one data symbol stream.

[0084] Table 1 shows an exemplary set of eight modes that may be supported by the system. Let m denote the mode, where $m = 1, 2, \dots, 8$. Each mode is associated with a specific modulation scheme (e.g., QPSK or 16-QAM) and a specific inner code rate $R_{in}(m)$ (e.g., $1/3$, $1/2$, or $2/3$). The first five modes are for “regular” coding with only the base stream, and the last three modes are for layered coding with the base and

enhancement streams. For simplicity, the same modulation scheme and inner code rate are used for both the base and enhancement streams for each layered coding mode.

Table 1

Mode m	Modulation Scheme	Inner Code Rate $R_{in}(m)$	Number Slots/ Packet $N_{spp}(m)$	Number Slots/ Subblock $N_{sps}(m)$
1	QPSK	1/3	3	12
2	QPSK	1/2	2	8
3	16-QAM	1/3	1.5	6
4	16-QAM	1/2	1	4
5	16-QAM	2/3	0.75	3
6	QPSK/QPSK	1/3	3	12
7	QPSK/QPSK	1/2	2	8
8	QPSK/QPSK	2/3	1.5	6

[0085] Table 1 also shows various transmission parameters for each mode. The fourth column of Table 1 indicates the number of slots needed to transmit one packet for each mode, which assumes a packet size of approximately 1000 information bits and 500 data subbands per slot. The fifth column indicates the number of slots needed to transmit one subblock of four packets for each mode. Different numbers of subband groups may be used for a PLC for all of the modes. The use of more subband groups results in shorter transmission time but also provides less time diversity.

[0086] As an example for mode 1, one data block with K data packets may be encoded to generate 16 coded packets. Each data packet contains 1000 information bits. Since mode 1 uses code rate $R_{in}(1) = 1/3$, each coded packet contains 3000 code bits and may be transmitted on 1500 data subbands (or three subband groups) using QPSK, which can carry two code bits per data symbol. The four coded packets for each subblock may be sent in 12 slots. Each subblock may be transmitted in a rectangular pattern of, e.g., dimension 4×3 , 3×4 , 2×6 , or 1×12 , where the first value P in dimension $P \times Q$ is for the number of subband groups and the second value Q is for the number of symbol periods for the rectangular pattern.

[0087] Table 1 shows an exemplary design, which is provided to show various parameters that may impact subband allocation and assignment. In general, the system

may support any number of modes, and each mode may correspond to a different coding and modulation scheme. For example, each mode may correspond to a different combination of modulation scheme and inner code rate. To simplify the design of the wireless devices, the system may utilize a single inner code (e.g., with a base code rate of 1/3 or 1/5), and different code rates may be achieved by puncturing or deleting some of the code bits generated by the inner code. However, the system may also utilize multiple inner codes. The maximum allowable number of subband groups for each mode may be different and possibly based on the maximum bit rate.

[0088] In general, one or multiple data blocks may be sent on an active PLC in each super-frame. The number of data blocks to be sent per super-frame is dependent on the data rate of the data stream being sent on the PLC. The number of slots (N_{slot}) to allocate to the PLC per frame is equal to the number of data blocks (N_{bl}) being sent on the PLC in the super-frame times the number of slots required for one subblock, or $N_{\text{slot}} = N_{\text{bl}} \cdot N_{\text{sps}}(m)$, where $N_{\text{sps}}(m)$ is dependent on the mode (m) used for the PLC. If the PLC carries a large number of data blocks in one super-frame (for a high-rate data stream), then it is desirable to use as many subband groups as possible in order to minimize the transmission time for the PLC. For example, if the PLC carries 16 data blocks in one super-frame, then the transmission time per frame using mode 1 is $192 = 16 \cdot 12$ symbol periods using one subband group (which is 65% of the frame duration) and only $48 = 192/4$ symbol periods using four subband groups (which is 16.25% of the frame duration). The transmission time for the PLC may thus be substantially shortened by using more subband groups.

[0089] FIG. 9A shows assignment of slots in a super-frame for one code block ($N_{\text{bl}} = 1$) using one subband group, which is equivalent to assignment of slots in a frame for one subblock. For the aspect described above, each subblock contains four packets that are labeled 1, 2, 3, and 4 in FIG. 9A. Each packet is transmitted in a different number of slots for each of modes 1 through 5 in Table 1. The four packets 1 through 4 for one subblock may be transmitted on one subband group in 12 symbol periods for mode 1, 8 symbol periods for mode 2, 6 symbol periods for mode 3, 4 symbol periods for mode 4, and 3 symbol periods for mode 5. For modes 3 and 5, two packets may share the same slot. Each packet may be decoded as soon as the entire packet is received.

[0090] FIG. 9B shows assignment of slots in a super-frame for one code block ($N_{bl} = 1$) using 4, 4, 3, 2, and 1 subband group for modes $m = 1, 2, 3, 4,$ and 5, respectively. The four packets in one subblock may be sent in a 4×3 rectangular pattern 932 for mode 1, a 4×2 rectangular pattern 934 for mode 2, a 3×2 rectangular pattern 936 for mode 3, a 2×2 rectangular pattern 938 for mode 4, and a 1×4 rectangular pattern 940 for mode 5.

[0091] In one aspect, the four packets in one subblock are transmitted in a vertical zigzag pattern 942 within a rectangular pattern, as shown in FIG. 9B. This aspect reduces buffering requirements since each packet is transmitted in as few symbol periods as possible and there is only one partial packet in any given symbol period. In another aspect, the four packets are transmitted in a horizontal zigzag pattern 944. This aspect provides more time diversity since each packet is transmitted over as many symbol periods as possible. However, the maximum bit rate may restrict the number of subband groups that may be used, or additional buffering may be needed, since up to two packets may be received in full in the same symbol period using the horizontal zigzag pattern.

[0092] FIG. 9C shows assignment of slots in a super-frame for six code blocks ($N_{bl} = 6$) using four subband groups. In this example, mode 2 is used for the PLC, each packet is sent in two slots, 24 packets are sent in each frame for the six code blocks, and the PLC is allocated 48 slots in a 4×12 rectangular pattern 952 for each frame. The 24 packets may be sent in various manners within rectangular pattern 952.

[0093] In a first aspect, which is shown in FIG. 9C, the packets are sent in the rectangular pattern by cycling through the six code blocks. For each cycle through the six code blocks, one packet is selected from each code block, and the six packets for the six code blocks are sent using the vertical zigzag pattern. The six packets 1 for the code blocks are sent in a box 954a, the six packets 2 for the code blocks are sent in a box 954b, the six packets 3 for the code blocks are sent in a box 954c, and the six packets 4 for the code blocks are sent in a box 954d. The j -th packet for the i -th code block is labeled as $B_i P_j$ in FIG. 9C.

[0094] The first aspect provides more time diversity across each code block since the four packets for the code block are sent over more symbol periods. Packets sent in one symbol period are likely to suffer from correlated erasures. For example, a deep fade during a symbol period may cause all packets sent in that symbol period to be

decoded in error. By sending packets from different code blocks in the same symbol period, the correlated (packet) erasures will be distributed over multiple code blocks. This enhances the ability of the block decoder to correct these erasures. The first aspect also spaces the four packets for each code block as far apart in time as possible, which improves time diversity across the code block. For example, the four packets for code block 1 are sent in symbol periods 1, 4, 7, and 10, and are spaced apart by three symbol periods. The first aspect also reduces buffering requirements since each packet is sent over as few symbol periods as possible.

[0095] In a second aspect, which is not shown in the figures, the packets are selected by cycling through the N_{bl} code blocks, similar to the first aspect, but the N_{bl} packets for each cycle are sent using the horizontal zigzag pattern within box 954. This aspect may provide more time diversity across each packet. In a third aspect, the four packets for one code block are sent first, the four packets for another code block are sent next, and so on. This aspect allows for early recovery of some code blocks. Multiple code blocks may thus be sent on a PLC in various manners.

[0096] As noted above, multiple PLCs may be intended to be jointly decoded. Each of the joint PLCs may carry any number of code blocks per super-frame depending on the data rate of the data stream being sent on the PLC. The total number of subband groups to use for the joint PLCs may be limited by the maximum bit rate.

[0097] FIG. 9D shows assignment of slots in a super-frame to two joint PLCs using horizontally stacked rectangular patterns. In this example, PLC 1 carries two code blocks using mode 4 (e.g., for a video stream), and eight packets are sent in eight slots for each frame. PLC 2 carries one code block using mode 2 (e.g., for an audio stream), and four packets are sent in eight slots for each frame. The eight packets for PLC 1 are sent in a 2×4 rectangular pattern 962 by cycling through the two code blocks and using the vertical zigzag pattern, as described above for FIG. 9C. The four packets for PLC 2 are sent in a 2×4 rectangular pattern 964 using the vertical zigzag pattern. Pattern 964 is stacked to the right of pattern 962.

[0098] FIG. 9E shows assignment of slots in a super-frame to two joint PLCs using vertically stacked rectangular patterns. The eight packets for PLC 1 are sent in a 1×8 rectangular pattern 972 by cycling through the two code blocks and using the vertical zigzag pattern, albeit with only one subband group. The four packets for PLC 2 are sent in a 2×4 rectangular pattern 974 using the vertical zigzag pattern. Pattern 974 is stacked on top of pattern 972. The use of the 1×8 rectangular pattern for PLC 1

ensures that only two packets are sent in each symbol period, which may be a restriction imposed by the maximum bit rate. A 2×4 rectangular pattern may be used for PLC 1, if allowed by the maximum bit rate, to reduce the total transmission time for both PLCs 1 and 2.

[0099] The examples shown in FIGS. 9D and 9E may be extended to cover any number of joint PLCs, any number of code blocks for each PLC, and any mode for each PLC. Slots may be assigned to the joint PLCs such that the total transmission time for these PLCs is minimized while conforming to the maximum bit rate.

[00100] For the outer coding scheme shown in FIG. 8, the first K packets of each code block are for data, and the last $N - K$ packets are for parity bits. Since each packet includes a CRC value, a wireless device can determine whether each packet is decoded correctly or in error by re-computing the CRC value using the received information bits of the packet and comparing the recomputed CRC value to the received CRC value. For each code block, if the first K packets are decoded correctly, then the wireless device does not need to process the last $N - K$ packets. For example, if $N = 16$, $K = 12$, and the last four packets of a code block are sent in the fourth frame, then the wireless device does not need to wake up in the last frame if the 12 data packets sent in the first three frames are decoded correctly. Furthermore, any combination of up to $N - K$ incorrectly (inner) decoded packets may be corrected by the Reed-Solomon decoder.

[00101] For clarity, the description above is based on a concatenated coding scheme comprised of an outer code and an inner code and for the parameters given in Table 1. Other coding schemes may also be used for the system. Furthermore, the same or different parameters may be used for the system. The subband allocation and assignment may be performed using the techniques described herein and in accordance with the specific coding scheme and parameters applicable to the system.

[00102] **FIG. 10** shows a flow diagram of a process 1000 for broadcasting multiple data streams using the multiplexing and transmission techniques described herein. Process 1000 may be performed for each super-frame.

[00103] Initially, the active PLCs for the current super-frame are identified (block 1012). For each active PLC, at least one data block is processed in accordance with the outer code (and rate) selected for the PLC to obtain at least one code block, one code block for each data block (block 1014). Each active PLC is allocated a specific number of transmission units based on the PLC's payload for the current super-frame (block

1016). In general, the transmission units in the current super-frame may be allocated to the active PLCs with any level of granularity. For example, the transmission units may be allocated to the active PLCs in slots, with each slot containing 500 transmission units. Specific transmission units in each frame of the current super-frame are then assigned to each active PLC (block 1018). Block 1016 determines the resource quantity allocated for each active PLC. Block 1018 provides the specific resource allocation for each active PLC and may be performed based on an assignment scheme. For example, the scheme that assigns rectangular patterns or the scheme that assign zigzag segments within strips may be used for block 1018. The allocation and assignment of transmission units may also be performed jointly since the allocation may be dependent on the packing efficiency achieved by the assignment.

[00104] Each code block for each active PLC is partitioned into multiple subblocks, one subblock for each frame (block 1020). Each packet in each subblock is then encoded by the inner code and mapped to modulation symbols (block 1022). The inner code rate and modulation scheme used for each PLC is determined by the mode selected for that PLC. The multiple subblocks for each code block are then sent in the multiple frames of the current super-frame to achieve time diversity. For each frame of the current super-frame, the data symbols in the subblock(s) to be sent in that frame for each active PLC are mapped onto the transmission units assigned to the PLC (block 1024). A composite symbol stream is then formed with (1) the multiplexed data symbols for all of the active PLCs and (2) pilot, overhead, and guard symbols (block 1026). The composite symbol stream is further processed (e.g., OFDM modulated and conditioned) and broadcast to wireless devices in the system.

[00105] The multiplexing and transmission techniques described herein allow the multiple data streams sent in each super-frame to be independently recoverable by a wireless device. A given data stream of interest may be recovered by (1) performing OFDM demodulation on all subbands or just the subbands used for the data stream, (2) demultiplexing the detected data symbols for the data stream, and (3) decoding the detected data symbols for the data stream. The other data streams need not be completely or partially decoded in order to receive the desired data stream. Depending on the allocation and assignment scheme selected for use, the wireless device may perform partial demodulation and/or partial decoding of another data stream in order to recover the data stream of interest. For example, if multiple data streams share the same

OFDM symbol, then the demodulation of a selected data stream may result in partial demodulation of an unselected data stream.

[00106] FIG. 11 shows a block diagram of a base station 110x, which is one of the base stations in system 100. At base station 110x, a transmit (TX) data processor 1110 receives multiple (N_{plc}) data streams (denoted as $\{d_1\}$ through $\{d_{N_{\text{plc}}}\}$) from one or more data sources 1108, e.g., multiple data sources for different services, where each service may be carried in one or more PLCs. TX data processor 1110 processes each data stream in accordance with the mode selected for that stream to generate a corresponding data symbol stream and provides N_{plc} data symbol streams (denoted as $\{s_1\}$ through $\{s_{N_{\text{plc}}}\}$) to a symbol multiplexer (Mux)/channelizer 1120. TX data processor 1110 also receives overhead data (which is denoted as $\{d_o\}$) from a controller 1140, processes the overhead data in accordance with the mode used for overhead data, and provides an overhead symbol stream (denoted as $\{s_o\}$) to channelizer 1120. An overhead symbol is a modulation symbol for overhead data.

[00107] Channelizer 1120 multiplexes the data symbols in the N_{plc} data symbol streams onto their assigned transmission units. Channelizer 1120 also provides pilot symbols on the pilot subbands and guard symbols on the guard subbands. Channelizer 1120 further multiplexes pilot symbols and overhead symbols in the pilot and overhead section preceding each super-frame (see FIG. 2). Channelizer 1120 provides a composite symbol stream (denoted as $\{s_c\}$) that carries data, overhead, pilot, and guard symbols on the proper subbands and symbol periods. An OFDM modulator 1130 performs OFDM modulation on the composite symbol stream and provides a stream of OFDM symbols to a transmitter unit (TMTR) 1132. Transmitter unit 1132 conditions (e.g., converts to analog, filters, amplifies, and frequency upconverts) the OFDM symbol stream and generates a modulated signal that then is transmitted from an antenna 1134.

[00108] FIG. 12 shows a block diagram of a wireless device 120x, which is one of the wireless devices in system 100. At wireless device 120x, an antenna 1212 receives the modulated signal transmitted by base station 110x and provides a received signal to a receiver unit (RCVR) 1214. Receiver unit 1214 conditions, digitizes, and processes the received signal and provides a sample stream to an OFDM demodulator 1220. OFDM demodulator 1220 performs OFDM demodulation on the sample stream and

provides (1) received pilot symbols to a channel estimator 1222 and (2) received data symbols and received overhead symbols to a detector 1230. Channel estimator 1222 derives a channel response estimate for the radio link between base station 110x and wireless device 120x based on the received pilot symbols. Detector 1230 performs detection (e.g., equalization or matched filtering) on the received data and overhead symbols with the channel response estimate. Detector 1230 provides to a symbol demultiplexer (Demux)/dechannelizer 1240 “detected” data and overhead symbols, which are estimates of the transmitted data and overhead symbols, respectively. The detected data/overhead symbols may be represented by log-likelihood ratios (LLRs) for the code bits used to form the data/overhead symbols, or by other representations. Channel estimator 1222 may also provide timing and frequency information to OFDM demodulator 1220.

[00109] A controller 1260 obtains an indication of (e.g., user selection for) one or more specific data streams/PLCs to be recovered. Controller 1260 then determines the resource allocation and assignment for each selected PLC. If wireless device 120x is acquiring the signal for the first time (e.g., initial acquisition), then the signaling information is obtained from the overhead OFDM symbols decoded by a receive (RX) data processor 1250. If wireless device 120x is successfully receiving data blocks in super-frames, then the signaling information may be obtained through the embedded overhead signaling that is part of at least one data block sent in each super-frame. This embedded overhead signaling indicates the allocation and assignment of the corresponding data stream/PLC in the next super-frame. Controller 1260 provides a MUX_RX control to dechannelizer 1240. Dechannelizer 1240 performs demultiplexing of the detected data or overhead symbols for each symbol period based on the MUX_RX control and provides one or more detected data symbol streams or a detected overhead symbol stream, respectively, to RX data processor 1250. In the case of the overhead OFDM symbols, RX data processor 1250 processes the detected overhead symbol stream in accordance with the mode used for overhead signaling and provides the decoded overhead signaling to controller 1260. For the data symbol stream(s), RX data processor 1250 processes each detected data symbol stream of interest, in accordance with the mode used for that stream, and provides a corresponding decoded data stream to a data sink 1252. In general, the processing at wireless device 120x is complementary to the processing at base station 110x.

[00110] Controllers 1140 and 1260 direct the operation at base station 110x and wireless device 120x, respectively. Memory units 1142 and 1262 provide storage for program codes and data used by controllers 1140 and 1260, respectively. Controller 1140 and/or a scheduler 1144 allocate resources to the active PLCs and further assign transmission units to each active PLC.

[00111] FIG. 13 shows a block diagram of an aspect of TX data processor 1110, channelizer 1120, and OFDM modulator 1130 at base station 110x. TX data processor 1110 includes N_{plc} TX data stream processors 1310a and 1310p for the N_{plc} data streams and a data stream processor 1310q for the overhead data. Each TX data stream processor 1310 independently encodes, interleaves, and modulates a respective data stream $\{d_i\}$ to generate a corresponding data symbol stream $\{s_i\}$.

[00112] FIG. 14 shows a block diagram of a TX data stream processor 1310i, which may be used for each of TX data stream processors 1310 in FIG. 13. TX data stream processor 1310i processes one data stream for one PLC. Data stream processor 1310i includes a base stream processor 1410a, an enhancement stream processor 1410b, and a bit-to-symbol mapping unit 1430. Processor 1410a processes a base stream for the PLC, and processor 1410b processes an enhancement stream (if any) for the PLC.

[00113] Within base stream processor 1410a, an outer encoder 1412a encodes each data block of base stream data in accordance with, e.g., a Reed-Solomon code to generate an RS code block. An RS code block consists of N outer coded packets. Encoder 1412a also appends a CRC value to each outer coded packet. This CRC value may be used by a wireless device for error detection (i.e., to determine whether the packet is decoded correctly or in error). An outer interleaver 1414a partitions each code block into subblocks, interleaves (i.e., reorders) the packets among the different subblocks that are transmitted in each frame, and buffers the subblocks transmitted in the different frames of a super-frame. An inner encoder 1416a then encodes each outer coded packet of a subblock in accordance with, e.g., a Turbo code to generate an inner coded packet. An inner bit interleaver 1418a interleaves the bits within each inner coded packet to generate a corresponding interleaved packet. The encoding by the outer encoder 1412a and inner encoder 1416a increases the reliability of the transmission for the base stream. The interleaving by outer interleaver 1414a and inner interleaver 1418a provides time and frequency diversity, respectively, for the base stream transmission. A scrambler 1420a randomizes the bits in each encoded and bit

interleaved packet with a PN sequence and provides scrambled bits to mapping unit 1430.

[00114] Enhancement stream processor 1410b similarly performs processing on the enhancement stream (if any) for the PLC. Processor 1410b may use the same inner code, outer code, and modulation scheme as those used for processor 1410a, or different ones. Processor 1410b provides scrambled bits for the enhancement stream to mapping unit 1430.

[00115] Mapping unit 1430 receives the scrambled bits for the base and enhancement streams, a gain G_{bs} for the base stream, and a gain G_{es} for the enhancement stream. The gains G_{bs} and G_{es} determine the amount of transmit power to use for the base and enhancement streams, respectively. Different coverage areas may be achieved for the base and enhancement streams by transmitting these streams at different power levels. Mapping unit 1430 maps the received scrambled bits to data symbols based on a selected mapping scheme and the gains G_{bs} and G_{es} . The symbol mapping may be achieved by (1) grouping sets of B scrambled bits to form B -bit binary values, where $B \geq 1$, and (2) mapping each B -bit binary value to a data symbol, which is a complex value for a point in a signal constellation for the selected modulation scheme. If layered coding is not used, then each data symbol corresponds to a point in a signal constellation such as M -PSK or M -QAM, where $M = 2^B$. If layered coding is used, then each data symbol corresponds to a point in a complex signal constellation, which may or may not be formed by the superposition of two scaled signal constellations. For the aspect described above, the base and enhancement streams carry the same number of code blocks for each super-frame. The code blocks for the base and enhancement streams may be transmitted simultaneously, as shown in FIG. 14, or transmitted using TDM and/or FDM.

[00116] Referring back to FIG. 13, channelizer 1120 is implemented with a multiplexer 1320 that receives the N_{plc} data symbol streams, the overhead symbol stream, pilot symbols, and guard symbols. Multiplexer 1320 provides the data symbols, overhead symbols, pilot symbols, and guard symbols onto the proper subbands and symbol periods based on a MUX_TX control from controller 1140 and outputs the composite symbol stream, $\{s_c\}$. In assigning modulation symbols to the subband groups, a further level of (symbol) interleaving can be performed by assigning modulation symbols in a pseudo-random fashion to the subbands within each subband

group. To simplify the assignment of subbands, the PLCs may be assigned slots, as described above. The slots may then be mapped to different subband groups, e.g., in a pseudo-random fashion from one symbol period to the next. This slot to subband group mapping ensures that the modulation symbols associated with a specific slot index have different distances from the pilot subbands for different symbol periods, which may improve performance.

[00117] OFDM modulator 1130 includes an inverse fast Fourier transform (IFFT) unit 1330 and a cyclic prefix generator 1332. For each symbol period, IFFT unit 1330 transforms each set of N_{tsb} symbols for the N_{tsb} total subbands to the time domain with an N_{tsb} -point IFFT to obtain a “transformed” symbol that contains N_{tsb} time-domain chips. To combat intersymbol interference (ISI), which is caused by frequency selective fading, cyclic prefix generator 1332 repeats a portion of each transformed symbol to form a corresponding OFDM symbol. The repeated portion is often called a cyclic prefix or guard interval. Cyclic prefix generator 1332 provides a stream of data chips (denoted as $\{c\}$) for the composite symbol stream, $\{s_c\}$.

[00118] The multiplexing and transmission techniques described herein may be implemented by various means. For example, these techniques may be implemented in hardware, software, or a combination thereof. For a hardware implementation, the processing units used to perform multiplexing and/or transmission at a base station may be implemented within one or more application specific integrated circuits (ASICs), digital signal processors (DSPs), digital signal processing devices (DSPDs), programmable logic devices (PLDs), field programmable gate arrays (FPGAs), processors, controllers, micro-controllers, microprocessors, other electronic units designed to perform the functions described herein, or a combination thereof. The processing units used to perform the complementary processing at a wireless device may also be implemented within one or more ASICs, DSPs, and so on.

[00119] For a software implementation, the techniques described herein may be implemented with modules (e.g., procedures, functions, and so on) that perform the functions described herein. The software codes may be stored in a memory unit (e.g., memory unit 1142 or 1262 in FIG. 11) and executed by a processor (e.g., controller 1140 or 1260). The memory unit may be implemented within the processor or external to the processor, in which case it can be communicatively coupled to the processor via various means as is known in the art.

[00120] The previous description of the disclosed aspects is provided to enable any person skilled in the art to make or use the present disclosure. Various modifications to these aspects will be readily apparent to those skilled in the art, and the generic principles defined herein may be applied to other aspects without departing from the scope of the disclosure. Thus, the present disclosure is not intended to be limited to the aspects shown herein but is to be accorded the widest scope consistent with the principles and novel features disclosed herein.

CLAIMS**WHAT IS CLAIMED IS:**

1. A method of broadcasting and multicasting data in a wireless multi-carrier communication system with various amounts of subbands, comprising:
 - processing a plurality of data streams to obtain a plurality of data symbol streams, one data symbol stream for each data stream;
 - allocating transmission units to each of the plurality of data streams, each transmission unit corresponding to one subband in one symbol period and being usable to transmit one data symbol;
 - mapping data symbols in each data symbol stream to respective transmission units allocated to the corresponding data stream; and
 - forming a composite symbol stream with data symbols, for the plurality of data streams, mapped to respective allocated transmission units, wherein a receiver determines which of the plurality of data streams to independently recover based on the data symbols included in the composite symbol stream for the data stream.
2. The method of claim 1, wherein said mapping comprises:
 - mapping, for a system with X useable subbands, a slot containing 500 useable subbands into $4000/X$ interlaces over $4000/X$ consecutive Y orthogonal frequency division multiplexing (OFDM) symbols.
3. The method of claim 1, wherein T total subbands are usable for transmitting data symbols in each symbol period used for broadcast and are allocable to multiple data streams, where $T > 1$.
4. The method of claim 3 wherein multiple data streams are allocated different groups of subbands in each symbol period used for broadcast and multicast.
5. The method of claim 4, wherein the subbands in each group are distributed across the T total subbands, and wherein the subbands in each group are interlaced with the subbands in other groups in same symbol period.

6. The method of claim 1, wherein each data stream is independently processed with a coding and modulation scheme selected for the data stream to obtain the corresponding data symbol stream.

7. The method of claim 1, wherein each of the plurality of data streams is independently encoded using a base inner code and a inner code rate selected for the data stream.

8. The method of claim 1, wherein transmission units are allocated to each data stream based on an information data rate of the data stream.

9. The method of claim 1, wherein transmission units are allocated to the plurality of data streams in each super-frame of a predetermined time duration.

10. The method of claim 1, wherein the multi-carrier communication system utilizes orthogonal frequency division multiplexing (OFDM).

11. The method of claim 1, further comprising:
selecting at least one data stream for recovery;
determining the transmission units used for each selected data stream;
obtaining by the receiver detected data symbols for each selected data stream, each detected data symbol being an estimate of a corresponding data symbol broadcast by a transmitter;

demodulating detected data symbols from transmission units used for each selected data stream onto a detected data symbol stream for the selected data stream, wherein at least one detected data symbol stream is obtained for the at least one data stream selected for recovery; and

processing each of the at least one detected data symbol stream to obtain a corresponding decoded data stream.

12. An apparatus in a wireless multi-carrier broadcast communication system using various amounts of subbands, comprising:

a data processor operative to process a plurality of data streams to obtain a plurality of data symbol streams, one data symbol stream for each data stream;

a controller operative to allocate transmission units to each of the plurality of data streams, each transmission unit corresponding to one subband in one symbol period and being usable to transmit one data symbol; and

a multiplexer operative to map data symbols in each data symbol stream to respective transmission units allocated to the corresponding data stream and to form a composite symbol stream with data symbols, for the plurality of data streams, mapped onto to respective allocated transmission units, wherein a receiver determines which of the plurality of data streams to independently recover based on the data symbols included in the composite symbol stream for the data stream.

13. The apparatus of claim 12, wherein said multiplexer is further operative to map, for a system with X useable subbands, a slot containing 500 useable subbands into $4000/X$ interlaces over $4000/X$ consecutive Y orthogonal frequency division multiplexing (OFDM) symbols.

14. The apparatus of claim 12, wherein T total subbands are usable for transmitting data symbols in each symbol period used for broadcast and are allocable to multiple data streams, where $T > 1$.

15. The apparatus of claim 14 wherein multiple data streams are allocated different groups of subbands in each symbol period used for broadcast and multicast.

16. The apparatus of claim 15, wherein the subbands in each group are distributed across the T total subbands, and wherein the subbands in each group are interlaced with the subbands in other groups in same symbol period.

17. The apparatus of claim 12, wherein each data stream is independently processed with a coding and modulation scheme selected for the data stream to obtain the corresponding data symbol stream.

18. The apparatus of claim 12, wherein each of the plurality of data streams is independently encoded using a base inner code and a inner code rate selected for the data stream.

19. The apparatus of claim 12, wherein transmission units are allocated to each data stream based on an information data rate of the data stream.

20. The apparatus of claim 12, wherein transmission units are allocated to the plurality of data streams in each super-frame of a predetermined time duration.

21. The apparatus of claim 12, wherein the multi-carrier communication system utilizes orthogonal frequency division multiplexing (OFDM).

22. The apparatus of claim 12, wherein the receiver is configured to:
select at least one data stream for recovery;
determine the transmission units used for each selected data stream;
obtain detected data symbols for each selected data stream, each detected data symbol being an estimate of a corresponding data symbol broadcast by a transmitter;
demodulate detected data symbols from transmission units used for each selected data stream onto a detected data symbol stream for the selected data stream, wherein at least one detected data symbol stream is obtained for the at least one data stream selected for recovery; and
process each of the at least one detected data symbol stream to obtain a corresponding decoded data stream.

23. An apparatus for broadcasting and multicasting data in a wireless multi-carrier communication system using various amounts of subbands, comprising:
means for processing a plurality of data streams to obtain a plurality of data symbol streams, one data symbol stream for each data stream;
means for allocating transmission units to each of the plurality of data streams, each transmission unit corresponding to one subband in one symbol period and being usable to transmit one data symbol;
means for mapping data symbols in each data symbol stream to respective transmission units allocated to the corresponding data stream; and
means for forming a composite symbol stream with data symbols, for the plurality of data streams, mapped to respective allocated transmission units, wherein a receiver determines which of the plurality of data streams to independently recover based on the data symbols included in the composite symbol stream for the data stream.

24. A computer-readable medium, in a wireless multi-carrier communication system using various amounts of subbands, storing instructions thereon, comprising:

instructions to process a plurality of data streams to obtain a plurality of data symbol streams, one data symbol stream for each data stream;

instructions to allocate transmission units to each of the plurality of data streams, each transmission unit corresponding to one subband in one symbol period and being usable to transmit one data symbol;

instructions to map data symbols in each data symbol stream to respective transmission units allocated to the corresponding data stream; and

instructions to form a composite symbol stream with data symbols, for the plurality of data streams, mapped to respective allocated transmission units, wherein a receiver determines which of the plurality of data streams to independently recover based on the data symbols included in the composite symbol stream for the data stream.

25. A processor executing instructions for broadcasting and multicasting data in a wireless multi-carrier communication system using various amounts of subbands, the instructions comprising:

processing a plurality of data streams to obtain a plurality of data symbol streams, one data symbol stream for each data stream;

allocating transmission units to each of the plurality of data streams, each transmission unit corresponding to one subband in one symbol period and being usable to transmit one data symbol;

mapping data symbols in each data symbol stream to respective transmission units allocated to the corresponding data stream; and

forming a composite symbol stream with data symbols, for the plurality of data streams, mapped to respective allocated transmission units, wherein a receiver determines which of the plurality of data streams to independently recover based on the data symbols included in the composite symbol stream for the data stream100.

1/15

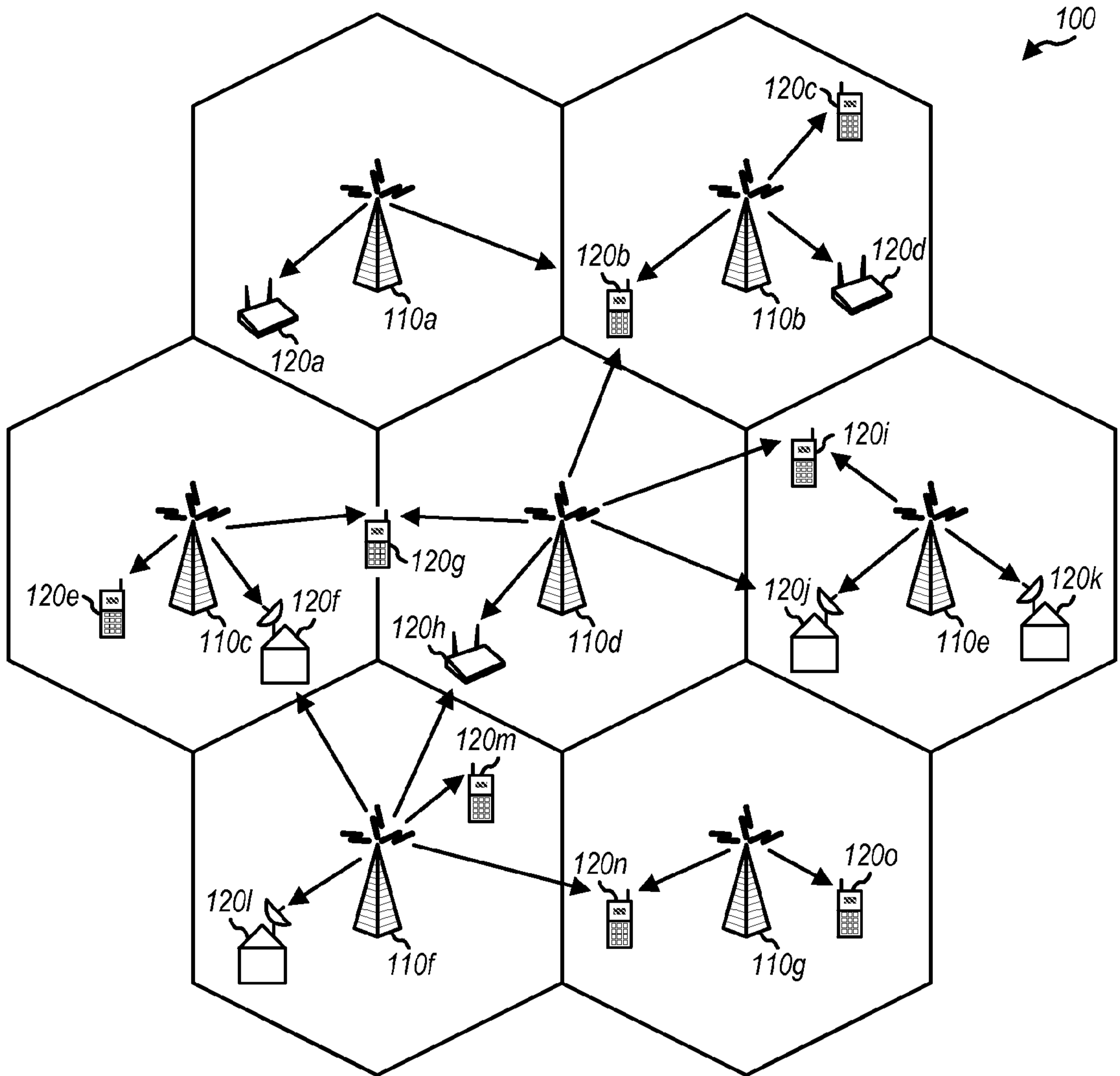

FIG. 1

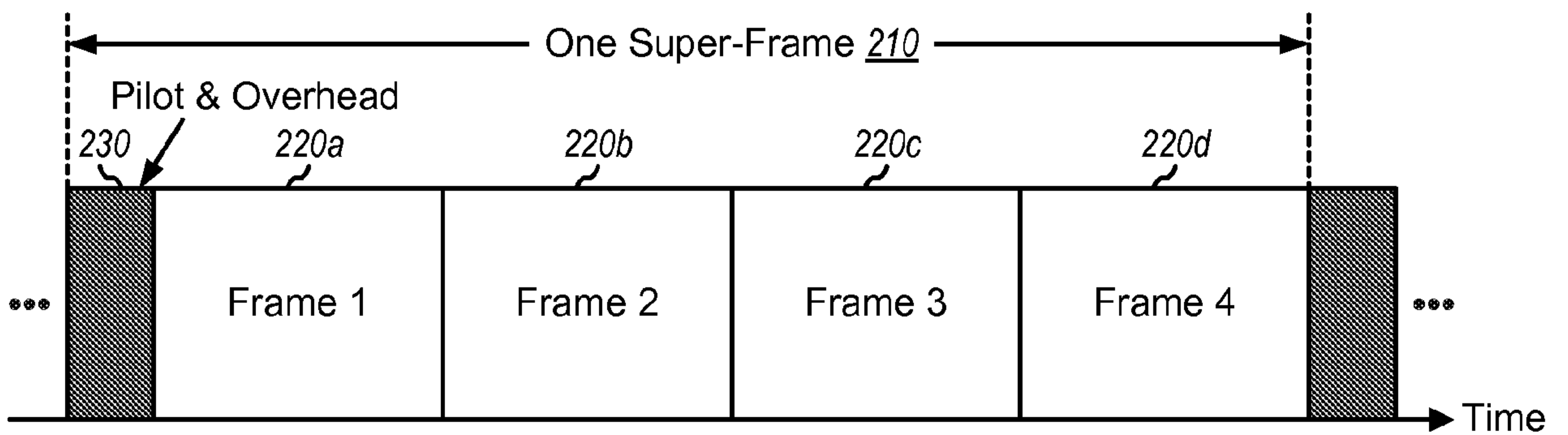

FIG. 2

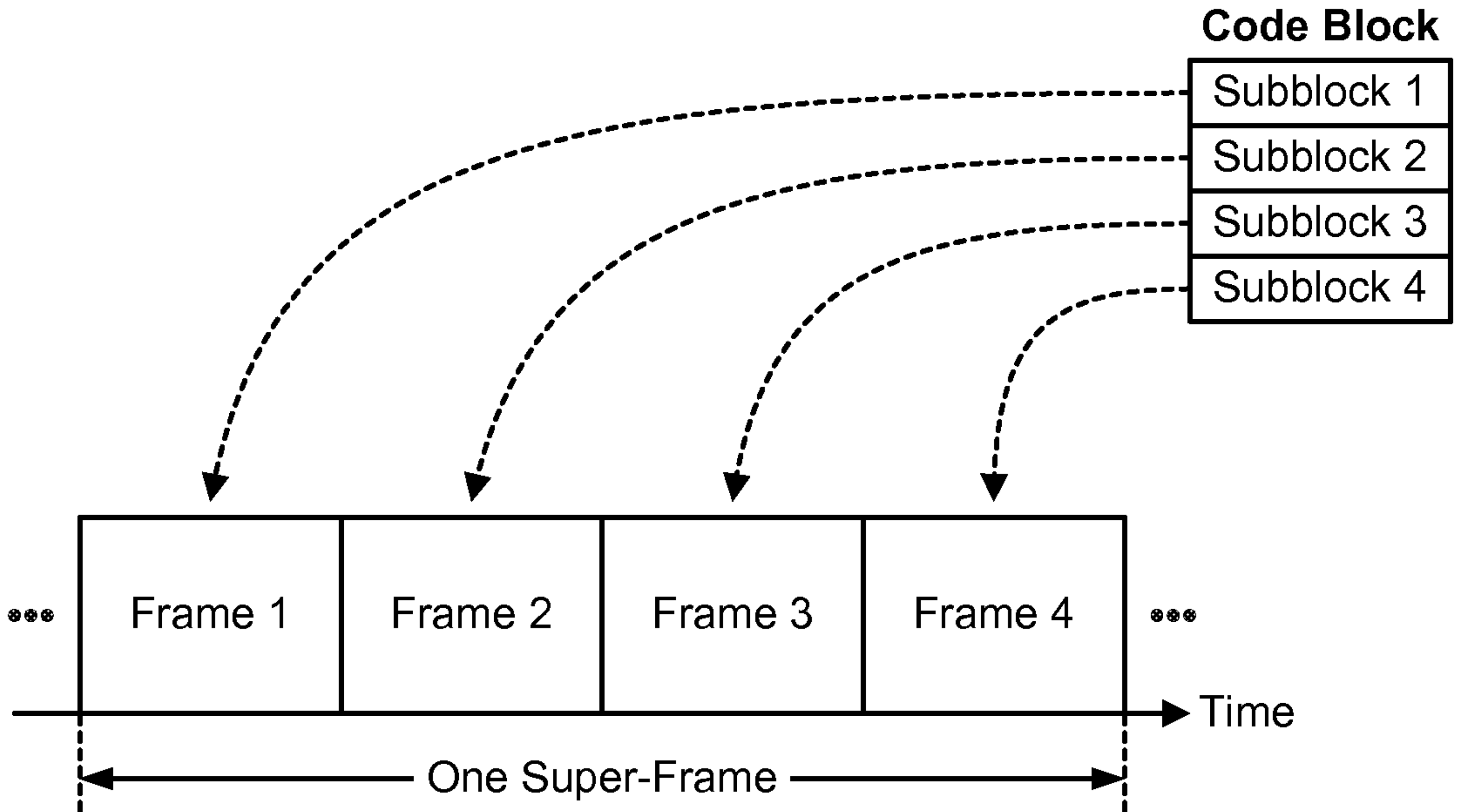

FIG. 3A

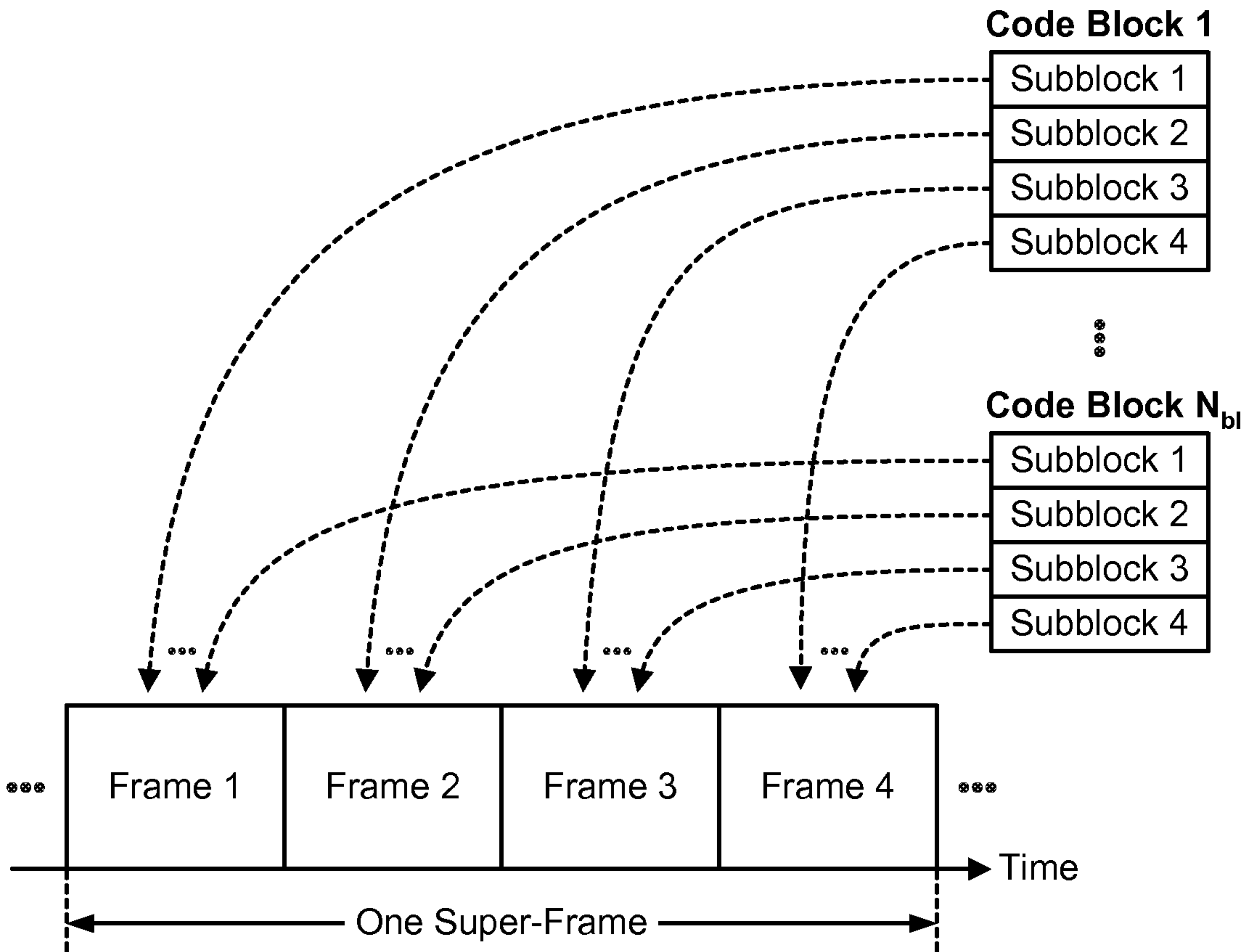

FIG. 3B

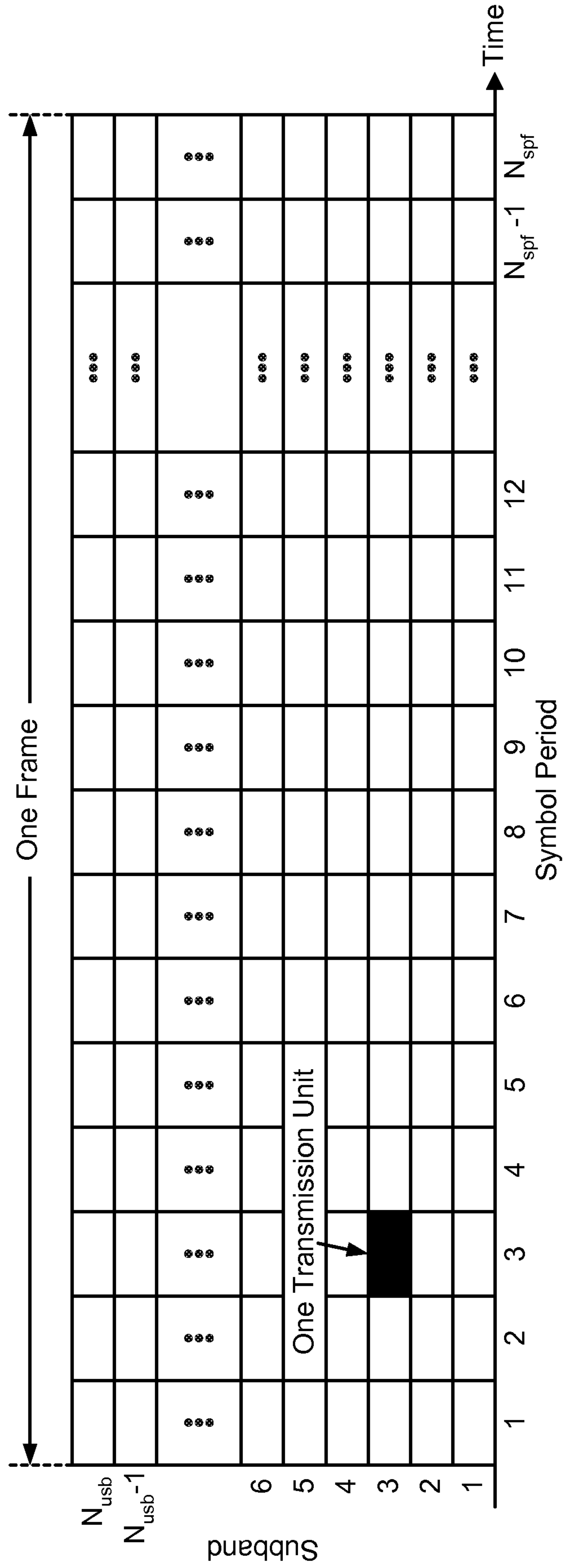

FIG. 4

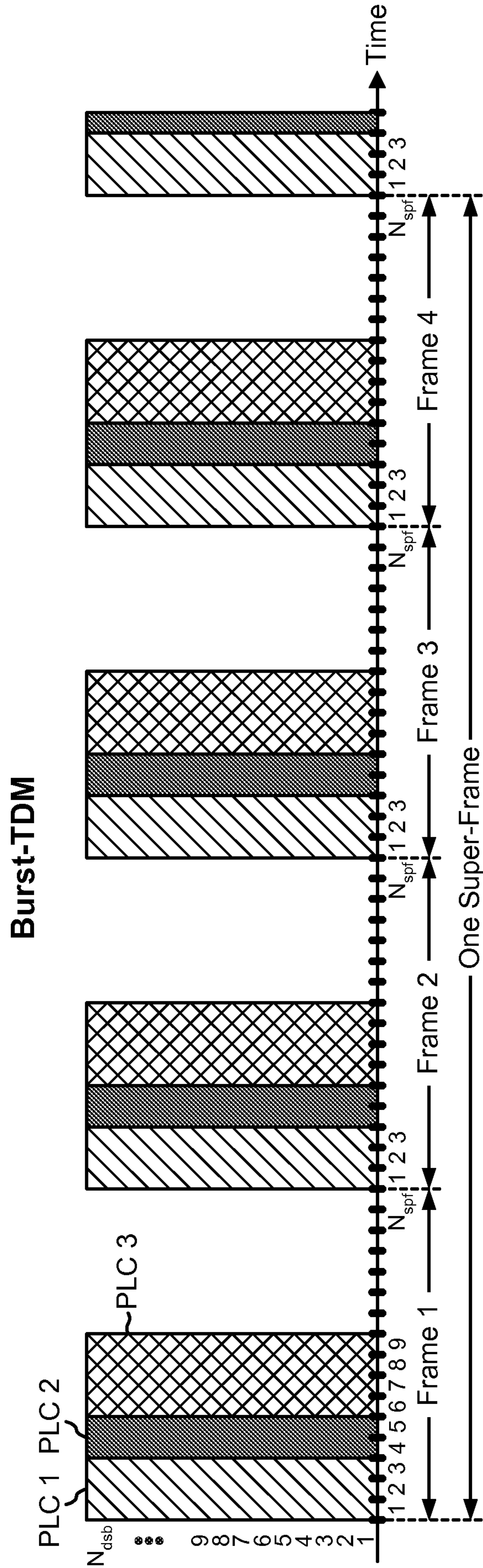

FIG. 5A

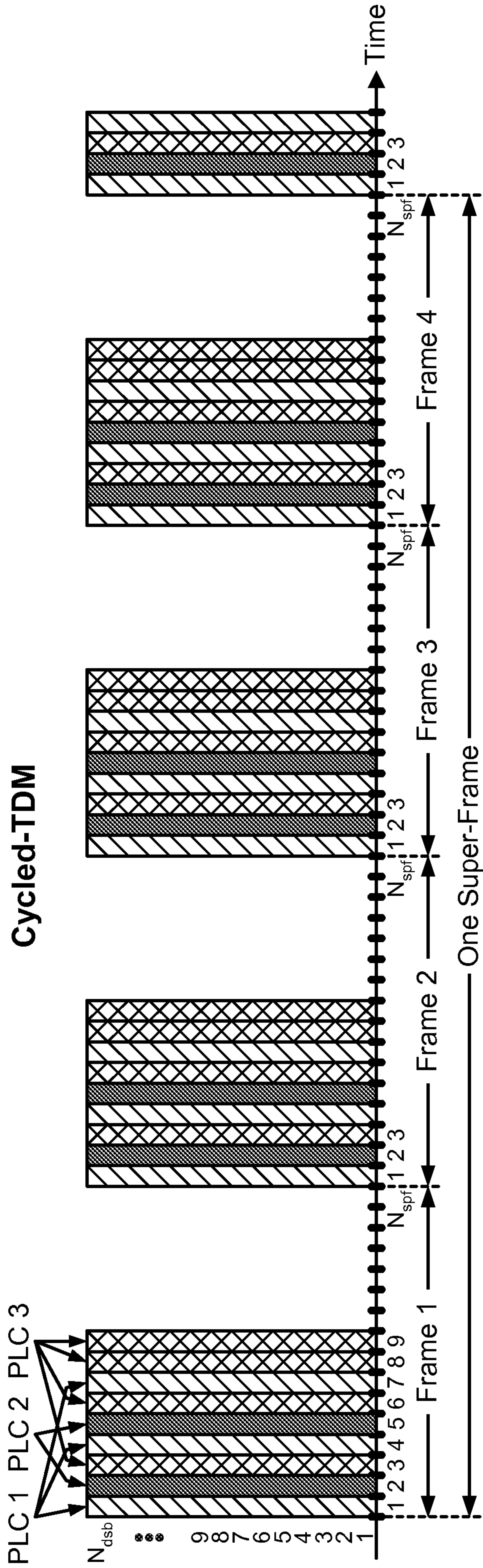

FIG. 5B

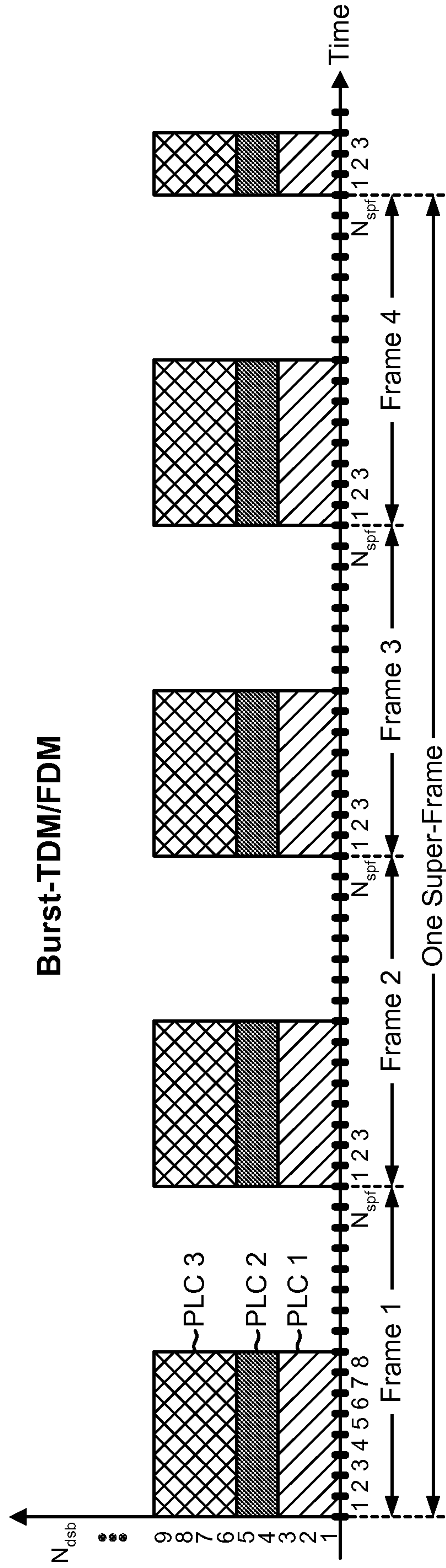

FIG. 5C

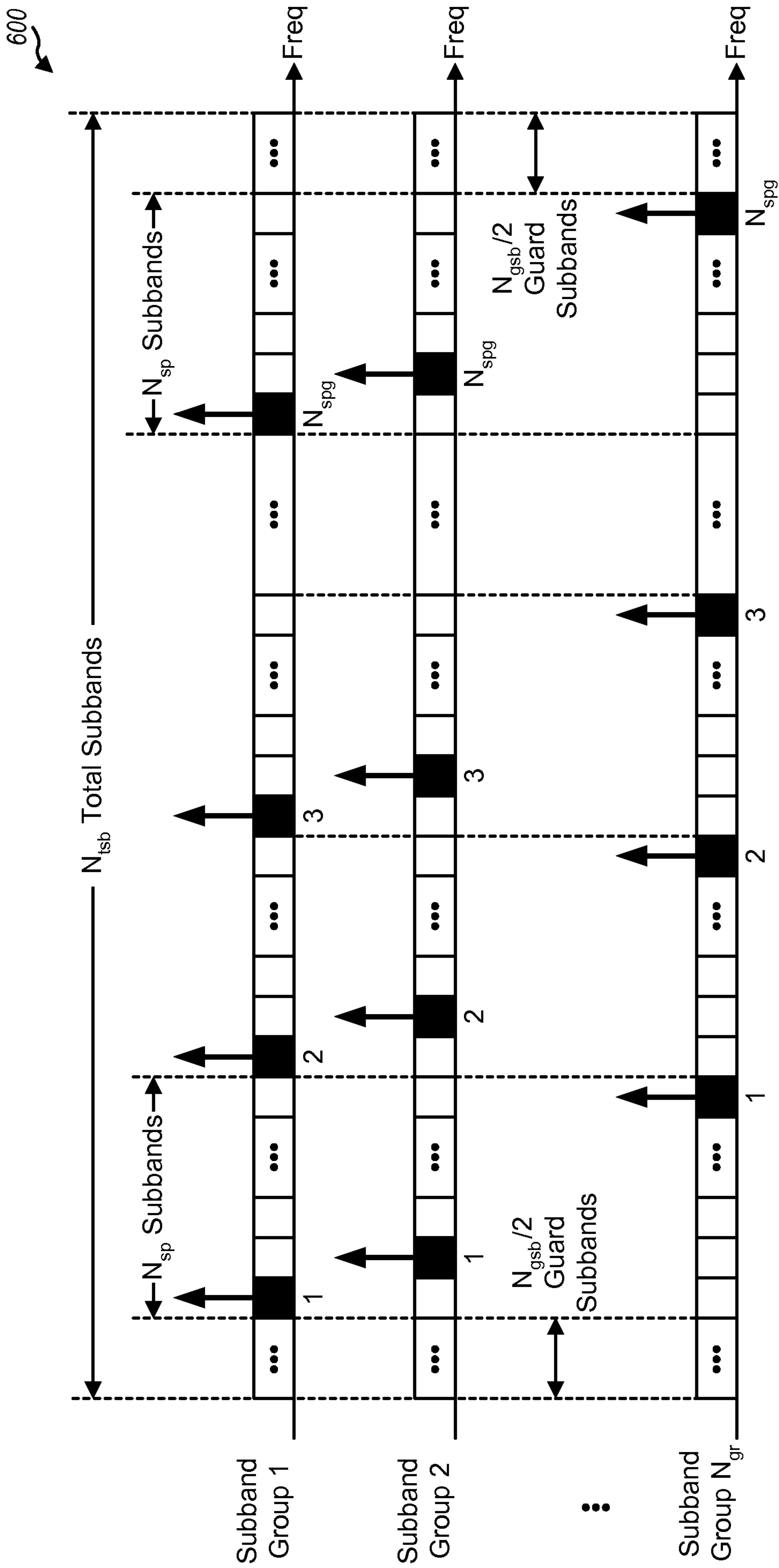

FIG. 6

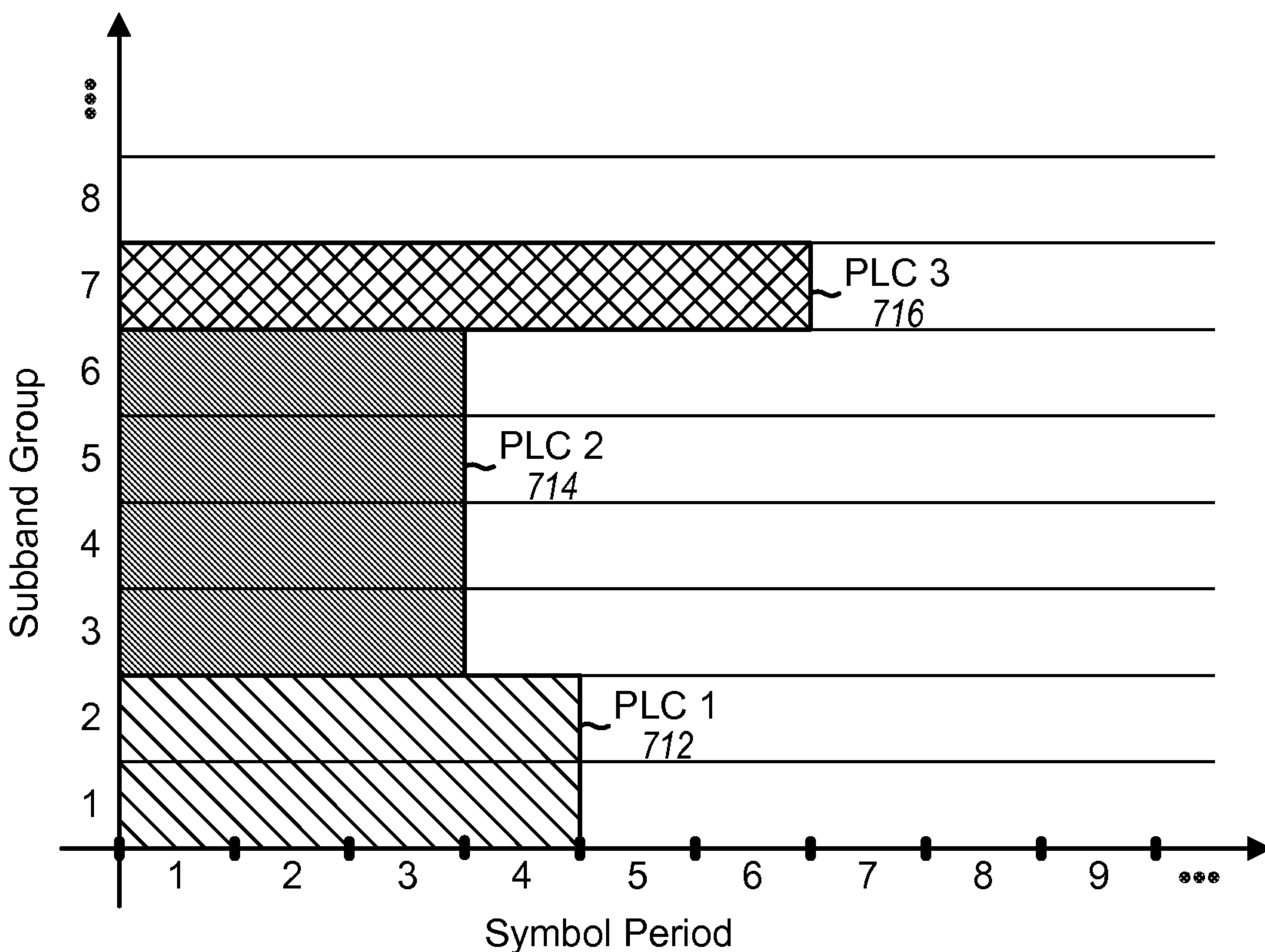

FIG. 7A

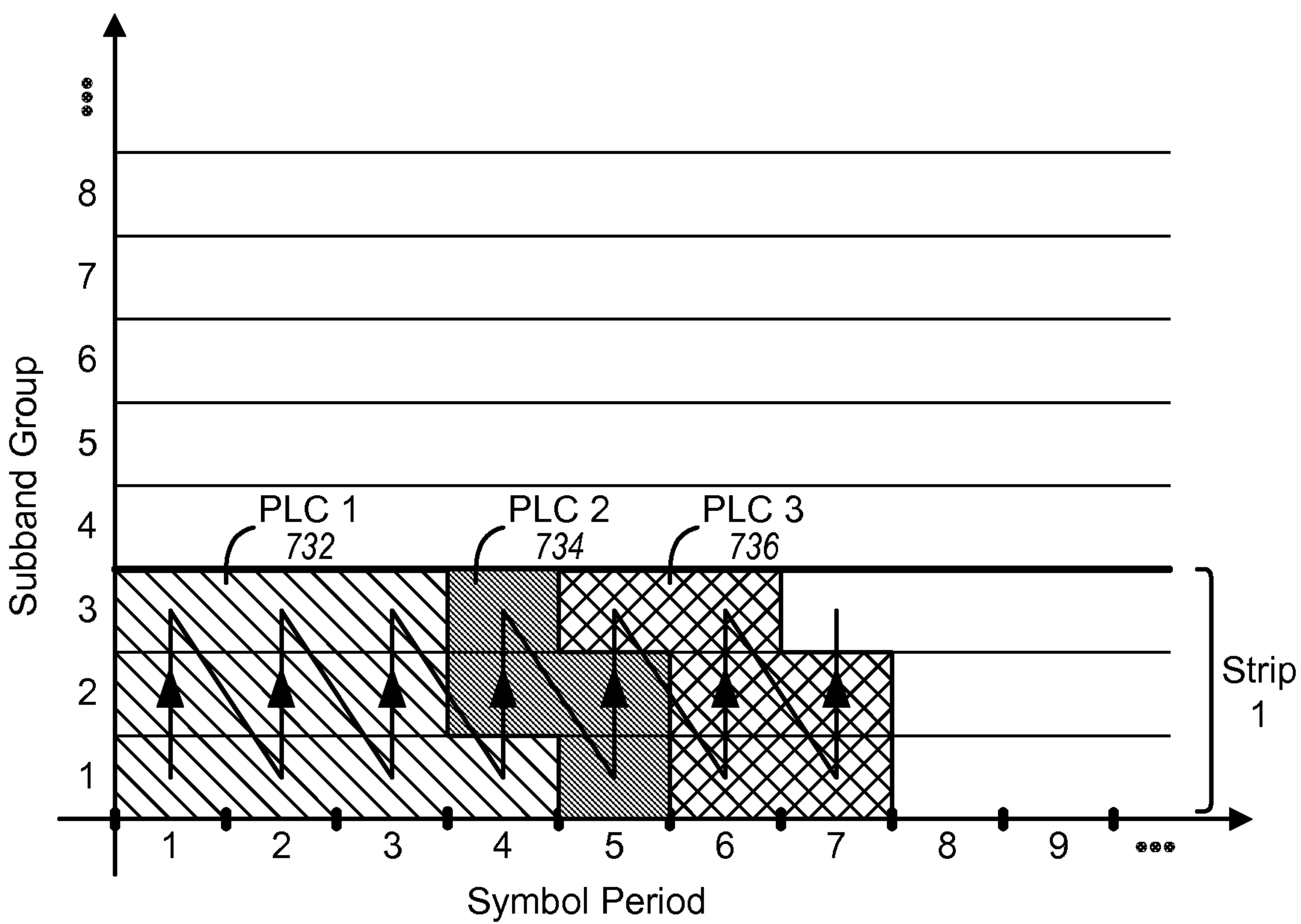

FIG. 7B

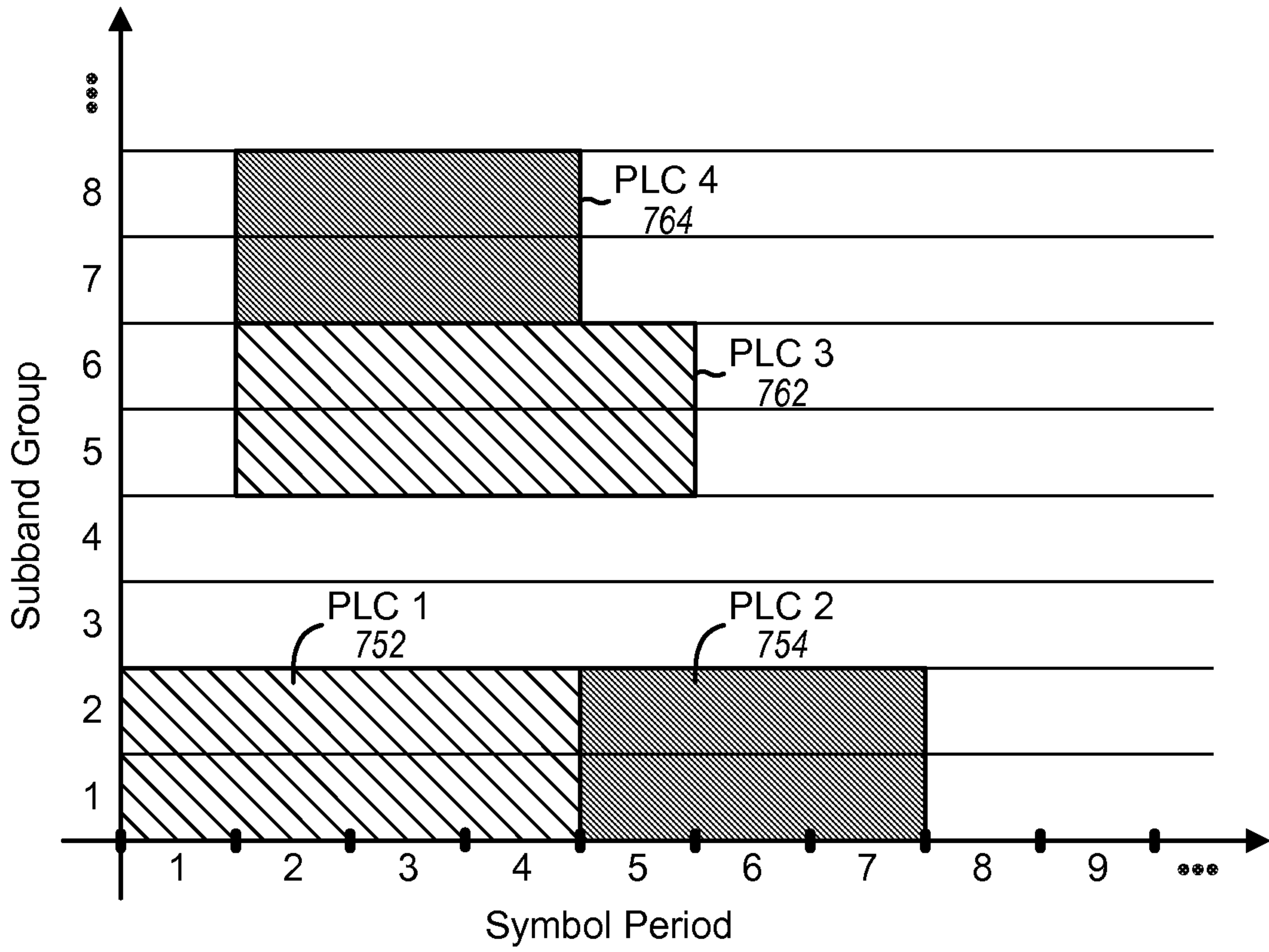

FIG. 7C

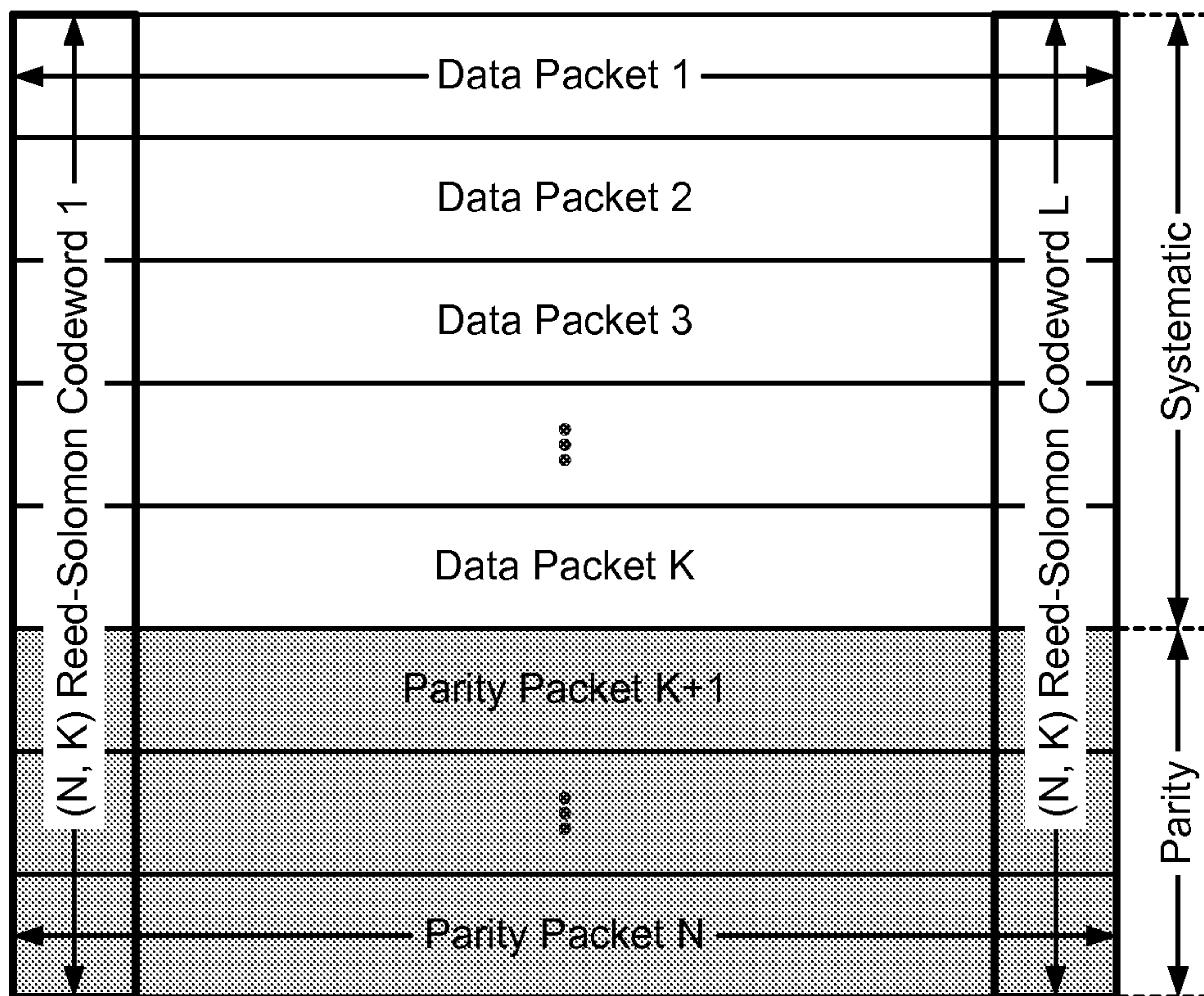

FIG. 8

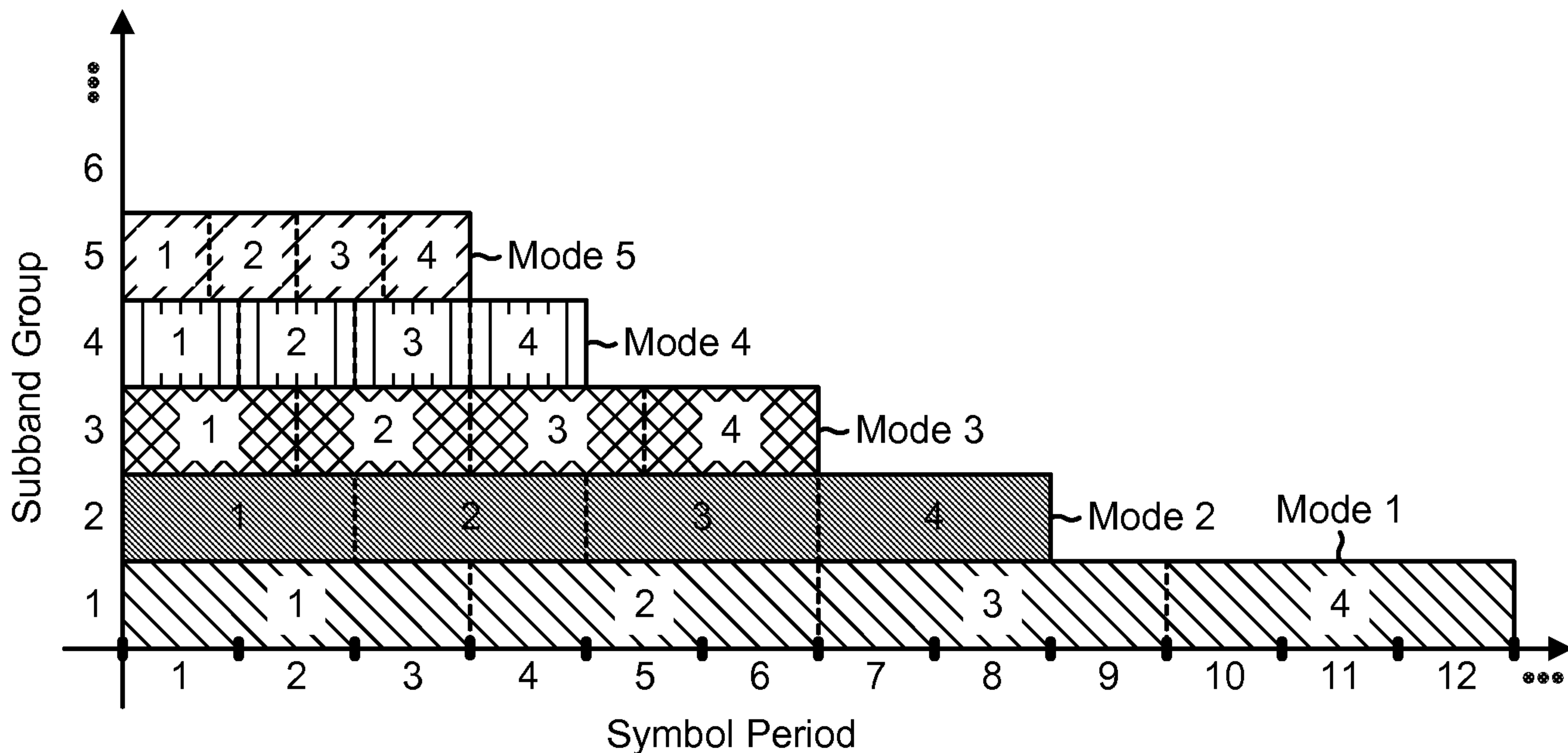

FIG. 9A

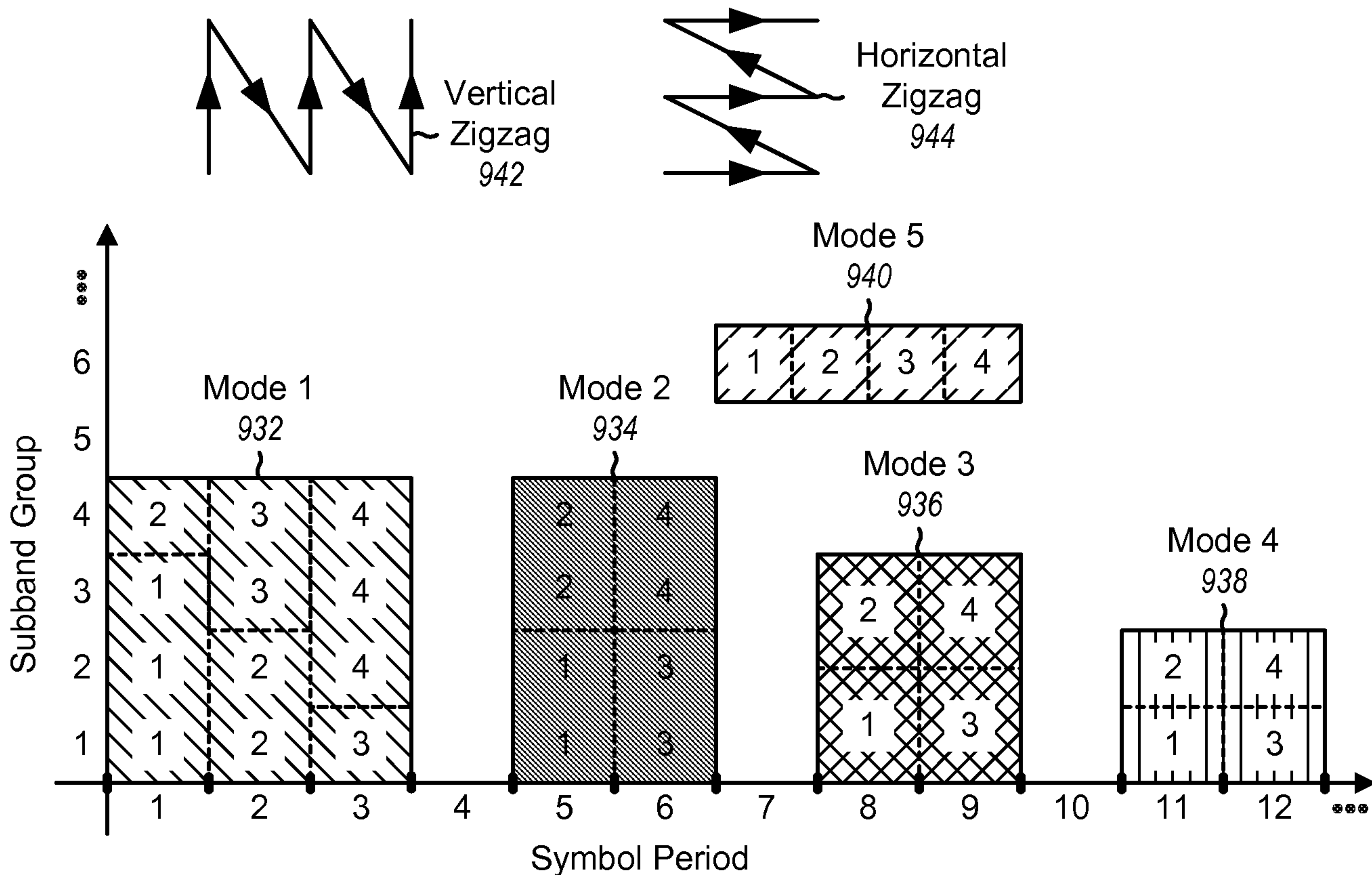

FIG. 9B

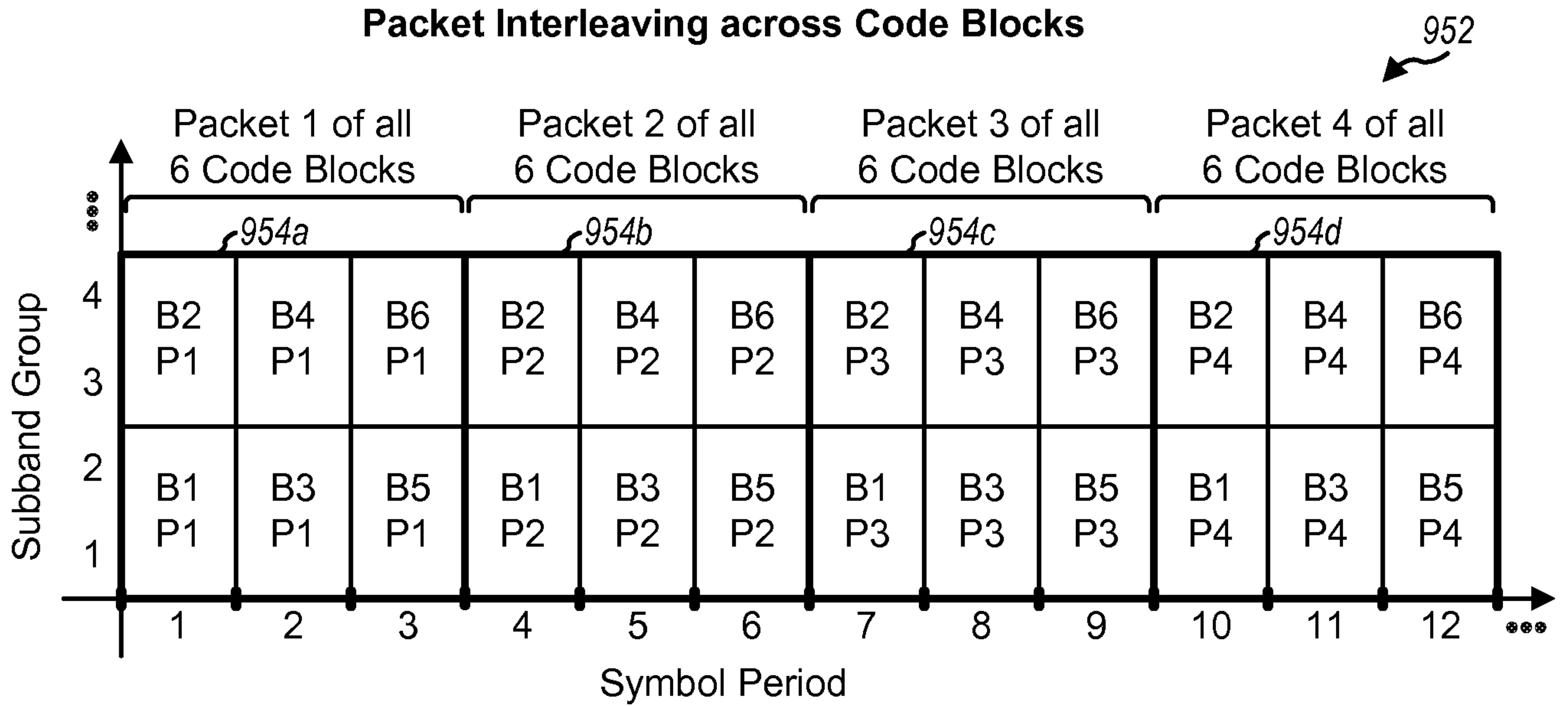

FIG. 9C

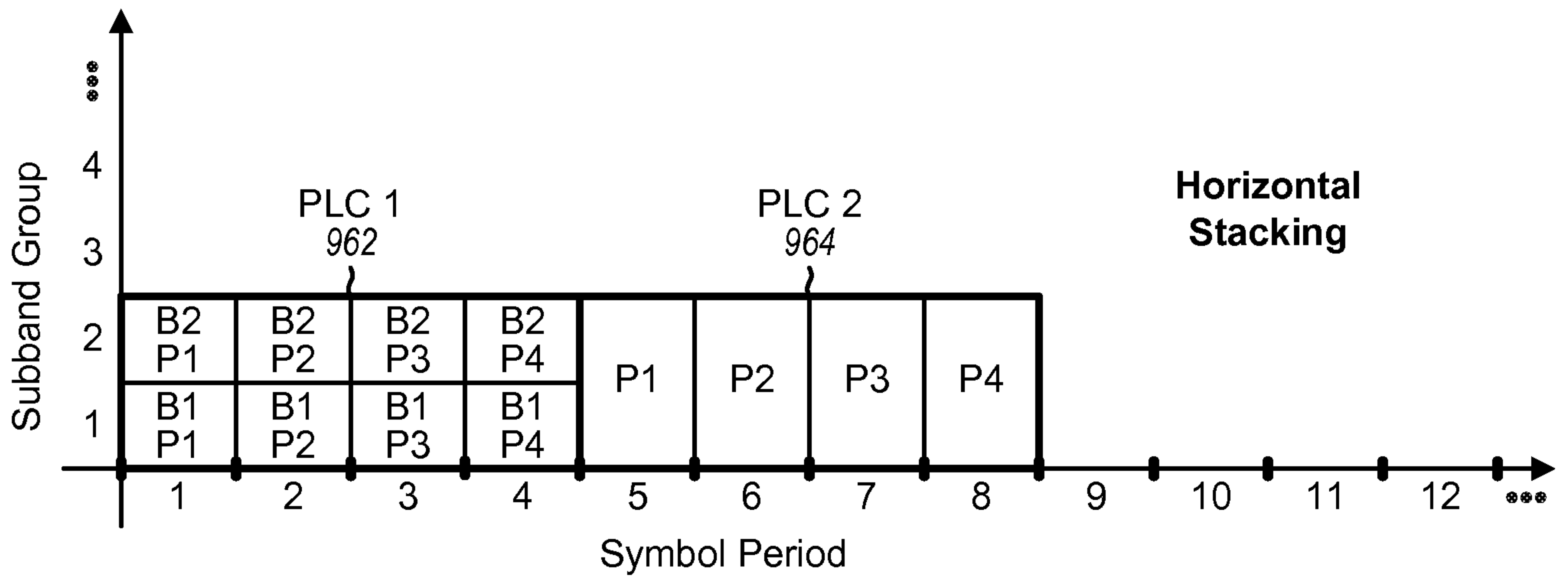

FIG. 9D

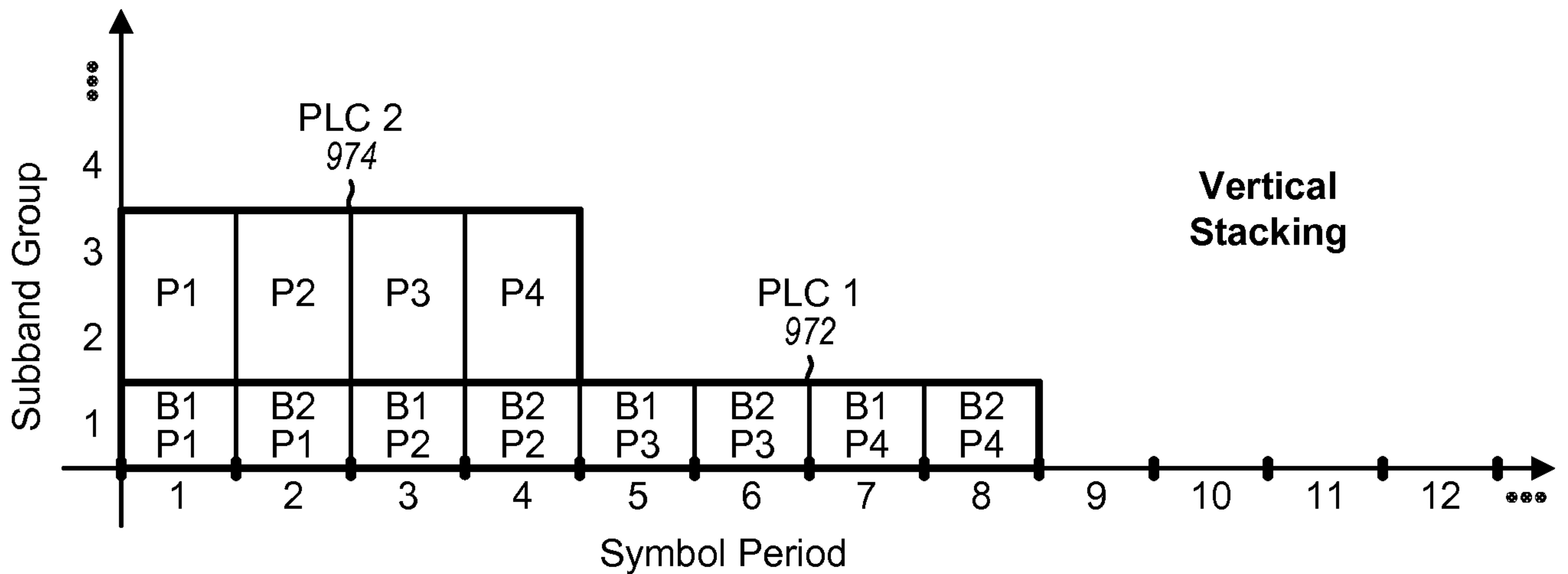

FIG. 9E

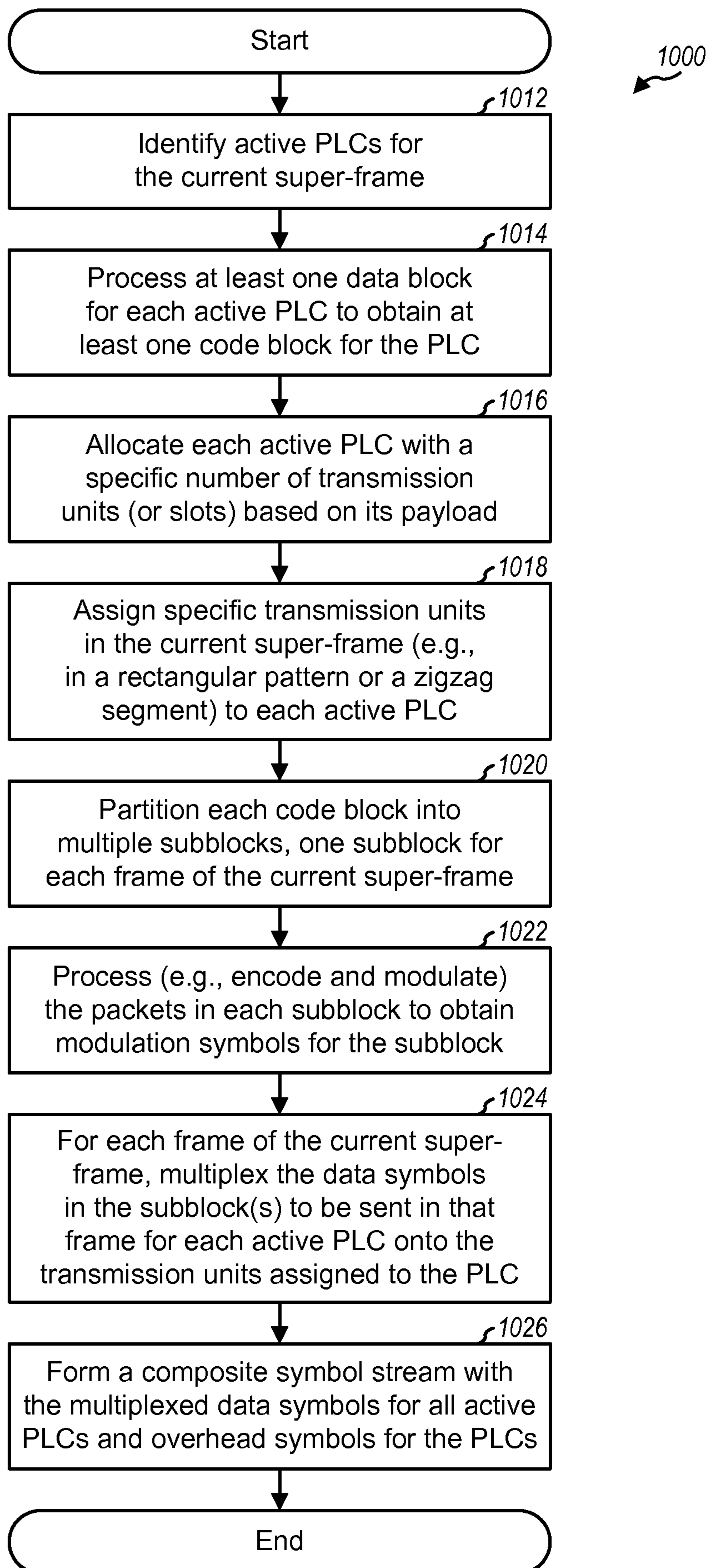

FIG. 10

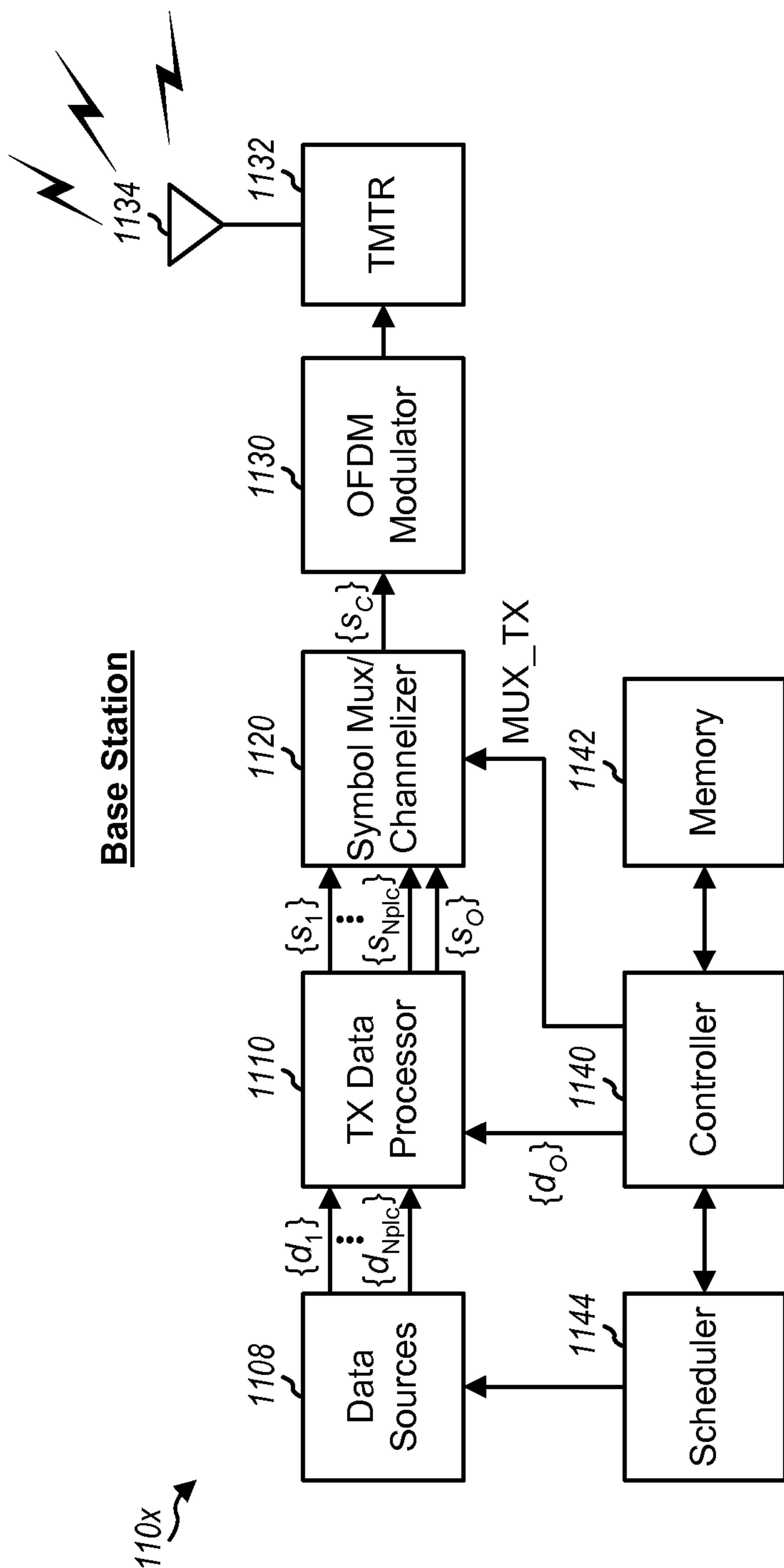

FIG. 11

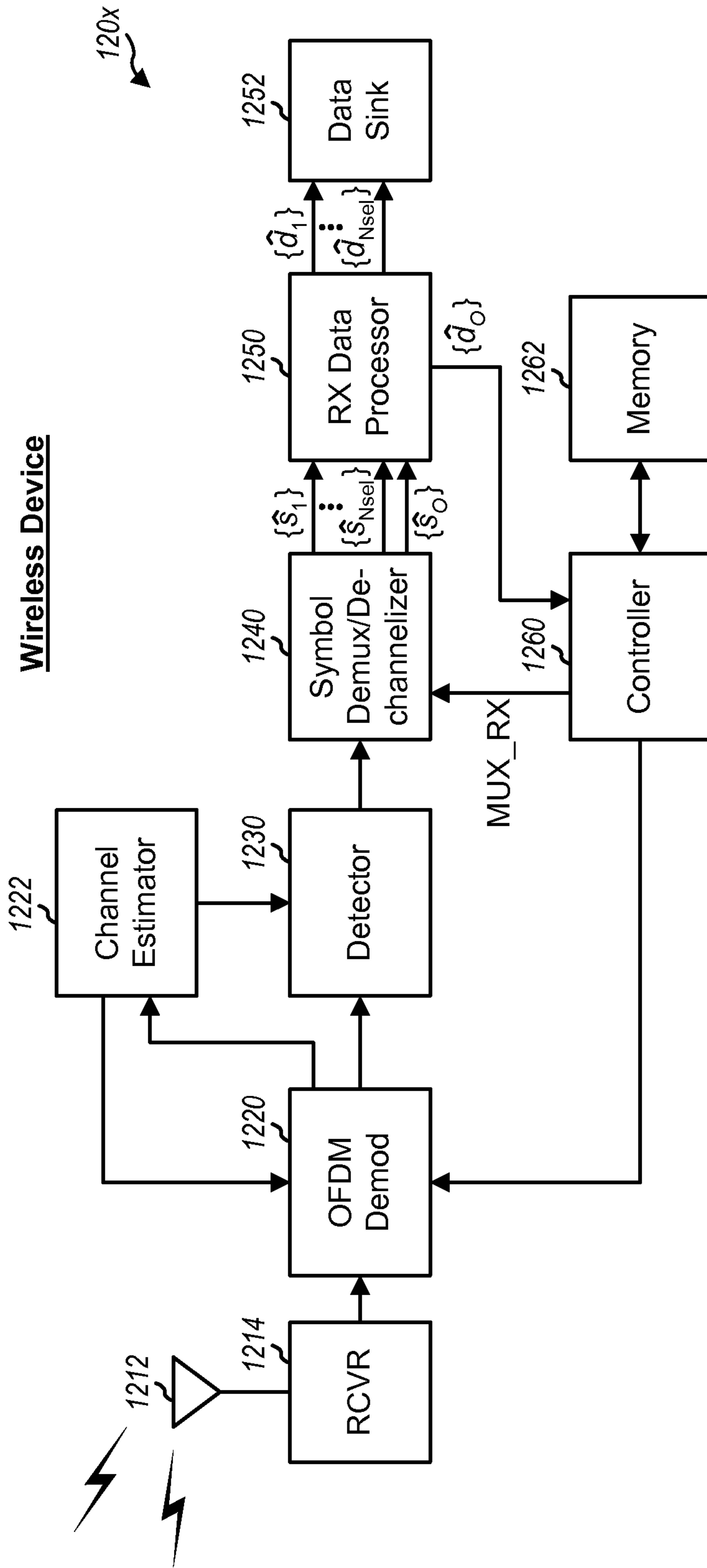

FIG. 12

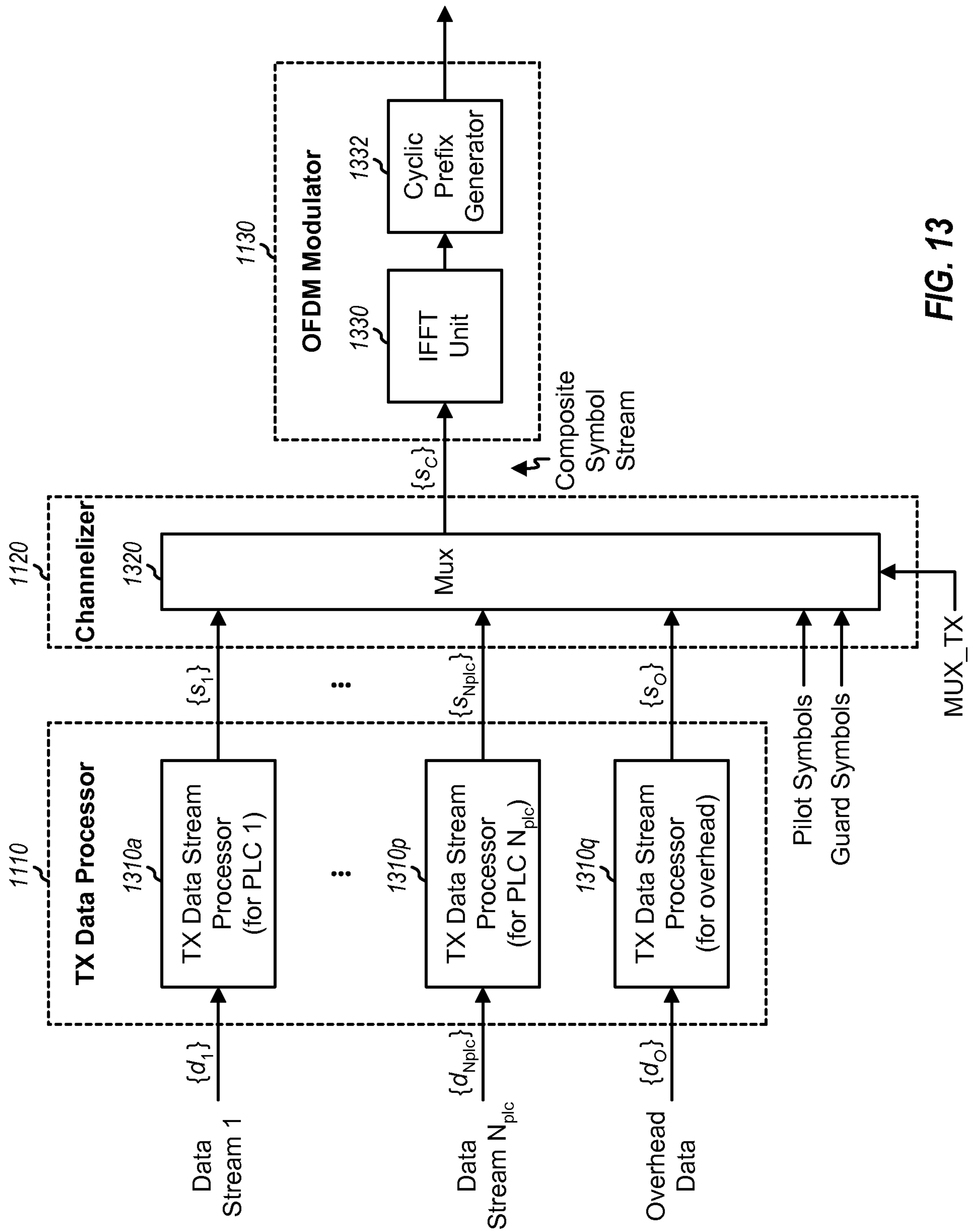

FIG. 13

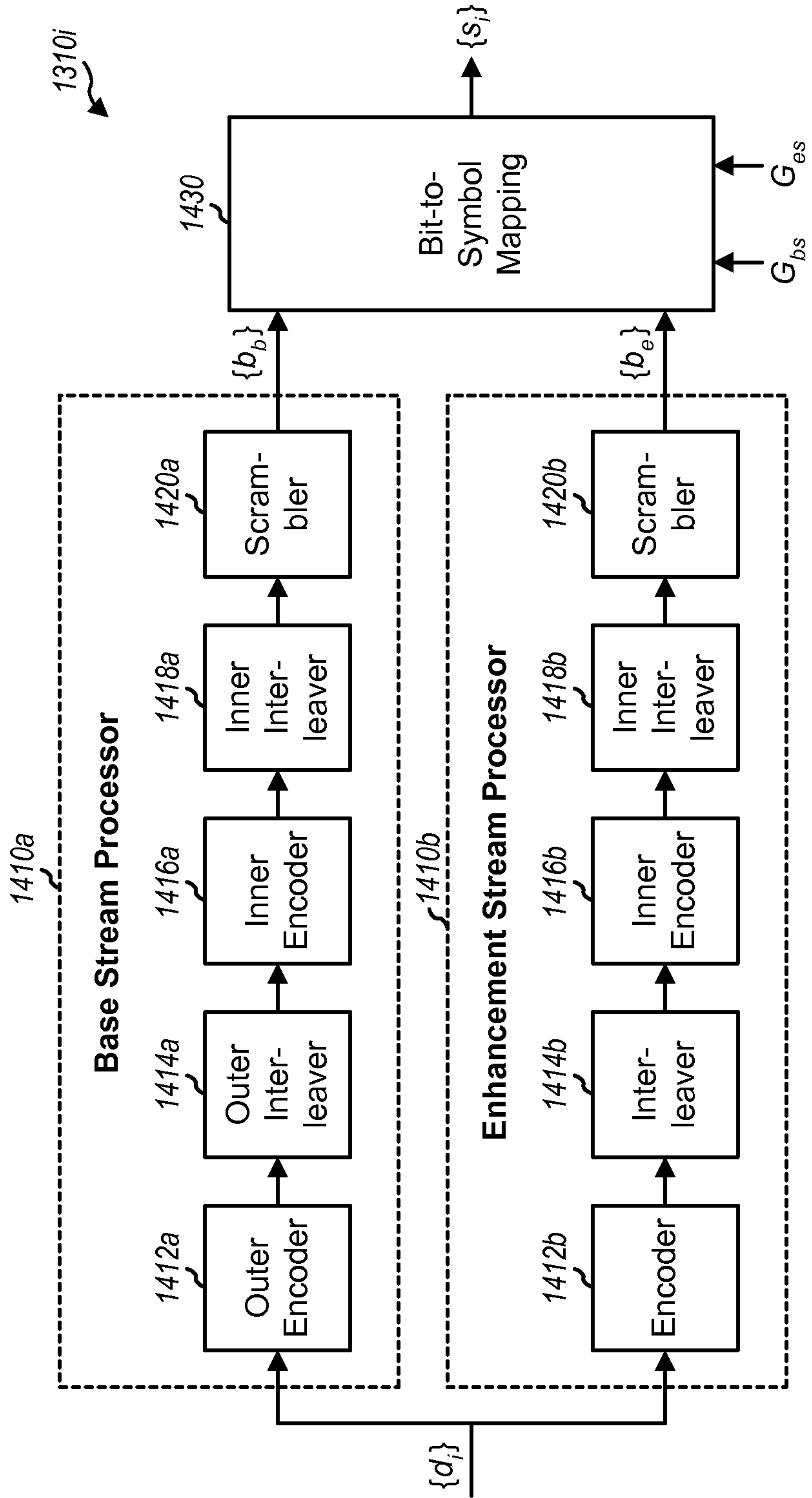

FIG. 14

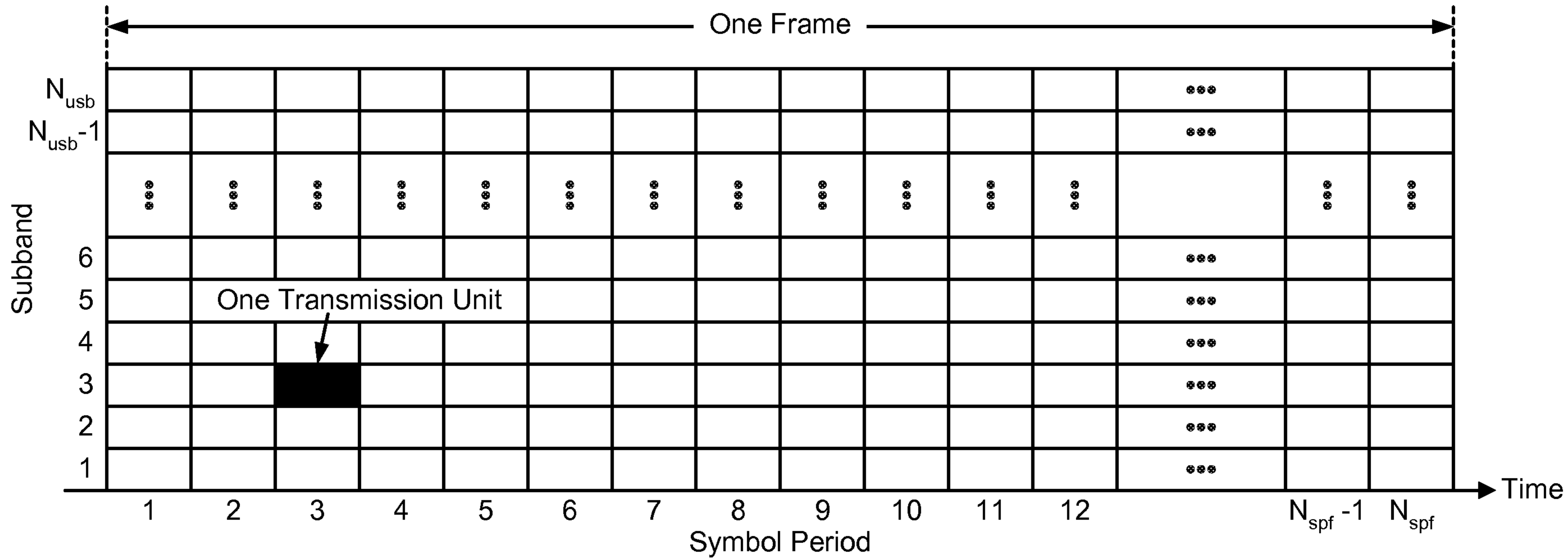

FIG. 4