



US00D888169S

(12) **United States Design Patent**
Chiu

(10) **Patent No.:** **US D888,169 S**

(45) **Date of Patent:** **** Jun. 23, 2020**

- (54) **TOE TRAINING APPARATUS**
- (71) Applicant: **Pei-Jung Chiu**, Lukang Township,
Changhua County (TW)
- (72) Inventor: **Pei-Jung Chiu**, Lukang Township,
Changhua County (TW)
- (**) Term: **15 Years**
- (21) Appl. No.: **29/683,428**
- (22) Filed: **Mar. 13, 2019**
- (51) **LOC (12) Cl.** **21-02**
- (52) **U.S. Cl.** **D21/685**
USPC **D21/685**
- (58) **Field of Classification Search**
USPC D21/662, 684, 685, 692, 694; 482/44,
482/47, 48, 49, 121, 122, 129;
73/379.01, 379.02; D29/113; D22/117
CPC A61H 1/0288; B43K 23/012; G09B 15/06;
A63B 23/16
See application file for complete search history.

5,445,582	A *	8/1995	Brown	A63B 23/16	482/124
D365,622	S *	12/1995	Edwards	D22/117	482/124
D416,594	S *	11/1999	Sardina	D21/684	482/124
D445,856	S *	7/2001	McCraw	D21/662	482/124
6,817,967	B1 *	11/2004	Ott	A63B 21/0004	482/47
D793,495	S *	8/2017	Ffrench	D21/684	482/47
D809,614	S *	2/2018	Chiu	D21/684	482/47
D829,286	S *	9/2018	Bae	D21/662	482/47
D858,661	S *	9/2019	Wang	D21/684	482/47
D865,085	S *	10/2019	Ishibashi	D21/685	482/47
10,512,590	B2 *	12/2019	Harrison	A63B 21/055	482/47
2007/0129216	A1 *	6/2007	Ott	A63B 21/055	482/47
2007/0254780	A1 *	11/2007	Findeisen	A63B 23/10	482/48
2008/0300112	A1 *	12/2008	Crout	A63B 21/0004	482/48
2011/0281688	A1 *	11/2011	Harris, Jr.	A63B 21/0428	482/48

(Continued)

Primary Examiner — Cynthia Ramirez
Assistant Examiner — Michael A Maharajh
(74) *Attorney, Agent, or Firm* — Alan D. Kamrath; Mayer & Williams PC

(56) **References Cited**
U.S. PATENT DOCUMENTS

2,546,118	A *	3/1951	Wright	A45D 29/22	132/73
3,360,261	A *	12/1967	Smolensky	A63H 33/00	482/44
3,612,521	A *	10/1971	Wendeborn	A63B 23/16	482/48
4,033,580	A *	7/1977	Paris	A63B 21/0004	482/122
4,828,249	A *	5/1989	Keating	A63B 23/16	482/121
5,062,625	A *	11/1991	Vonk	A63B 21/0004	482/48
D325,611	S *	4/1992	Lewis	D21/684	482/48
5,136,911	A *	8/1992	Wyss	A61H 1/0288	482/48

(57) **CLAIM**

The ornamental design for a toe training apparatus, as shown and described.

DESCRIPTION

FIG. 1 is a perspective view of a toe training apparatus showing my design;
FIG. 2 is a front elevational view thereof;
FIG. 3 is a rear elevational view thereof;
FIG. 4 is a left side elevational view thereof;
FIG. 5 is a right side elevational view thereof;
FIG. 6 is a top plan view thereof; and,
FIG. 7 is a bottom plan view thereof.

1 Claim, 7 Drawing Sheets

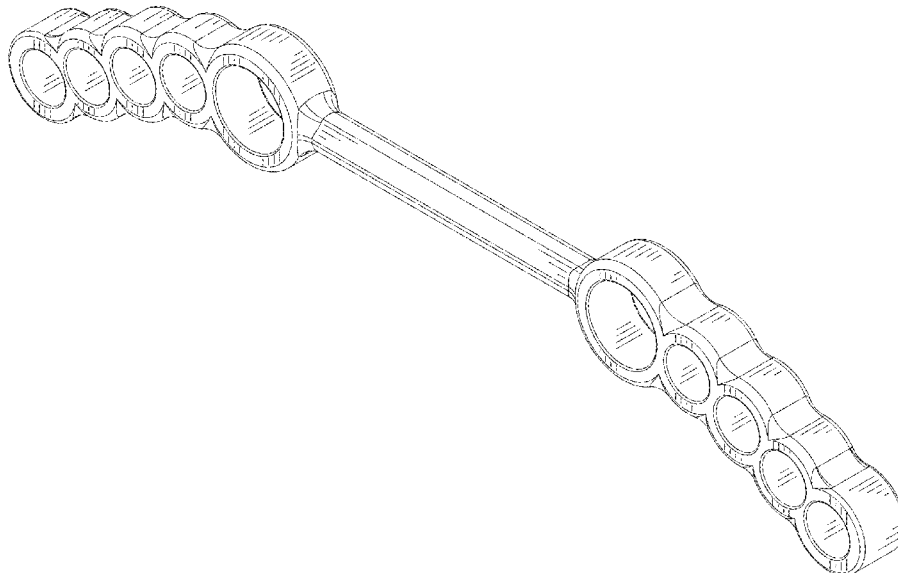

(56)

References Cited

U.S. PATENT DOCUMENTS

2012/0065027 A1* 3/2012 Zachary A63B 21/0004
482/48
2013/0303336 A1* 11/2013 Goldberg A63B 23/16
482/44
2018/0240354 A1* 8/2018 Carrick G09B 15/06

* cited by examiner

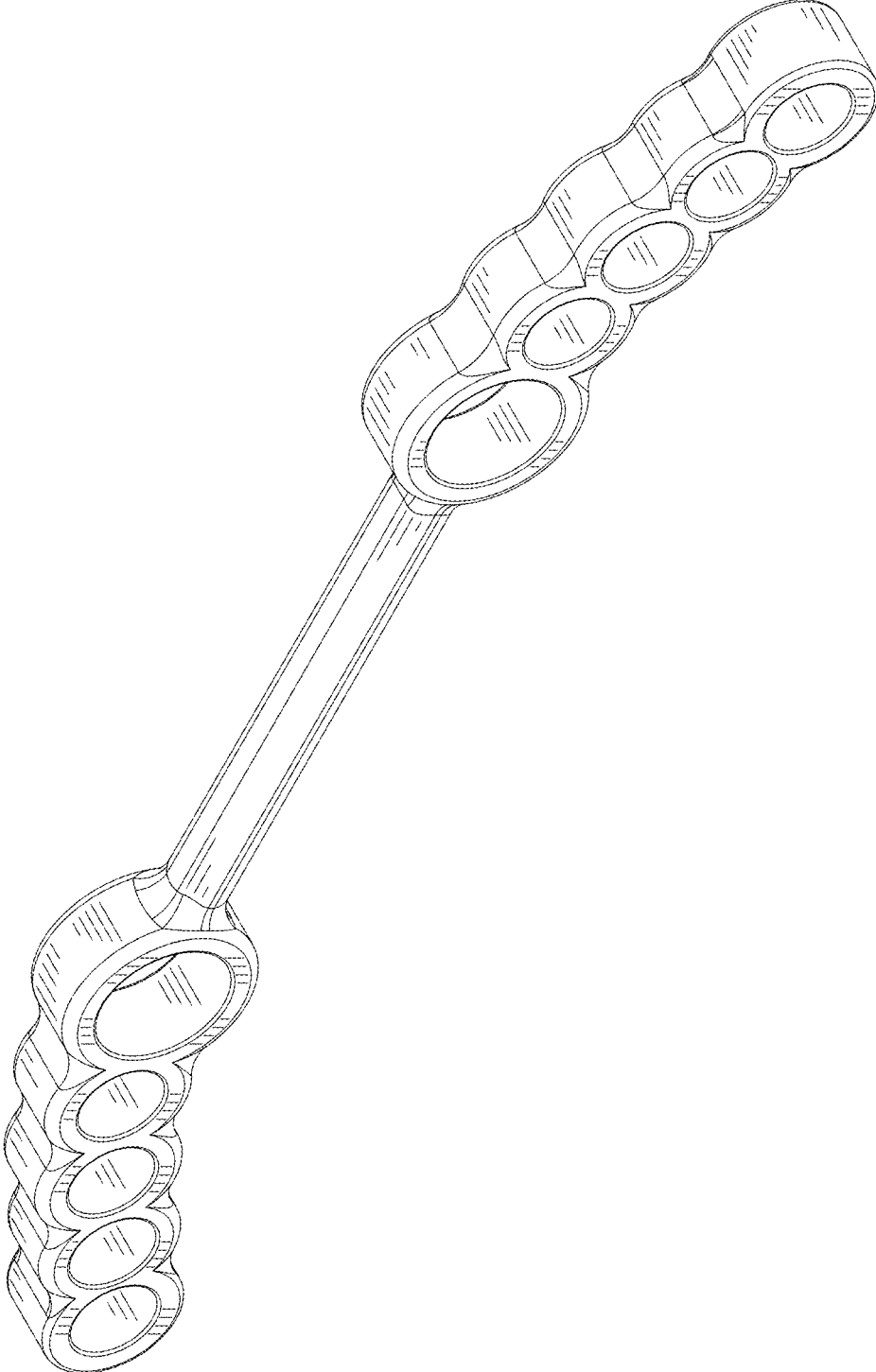

FIG. 1

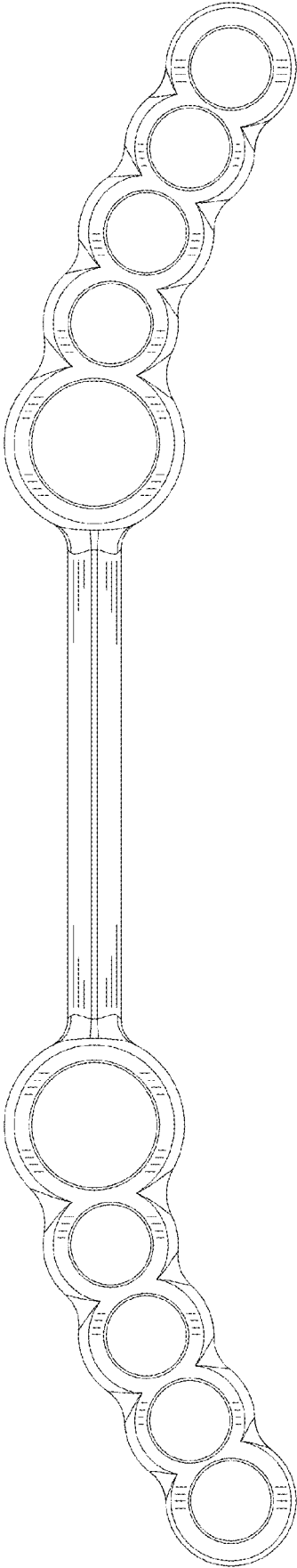

FIG. 2

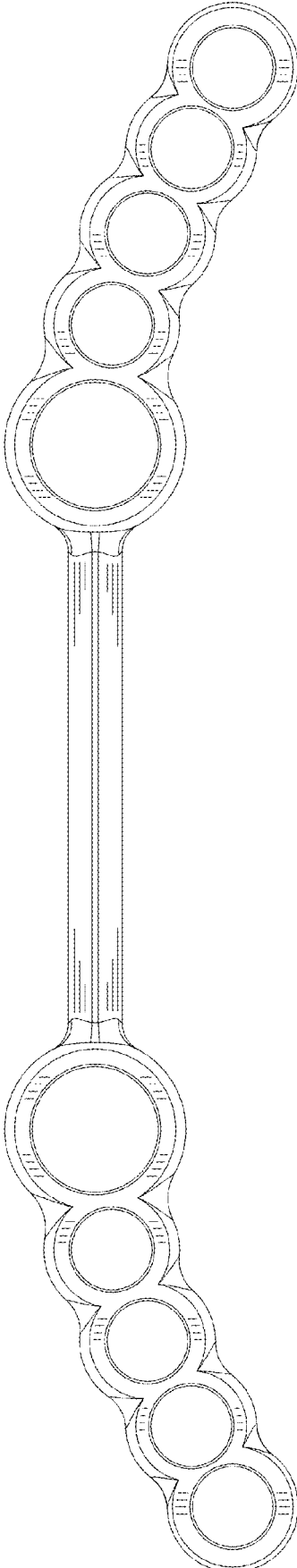

FIG. 3

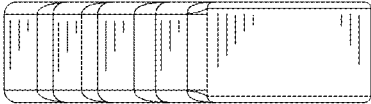

FIG. 4

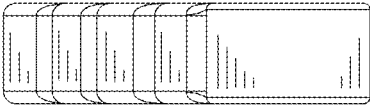

FIG. 5

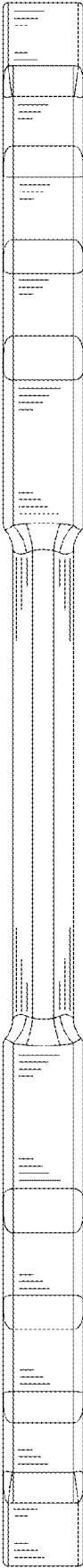

FIG. 6



FIG. 7