



- (51) **International Patent Classification:**
H04B 7/04 (2006.01) *H04W 74/00* (2009.01)
- (21) **International Application Number:**
PCT/KR2011/009107
- (22) **International Filing Date:**
28 November 2011 (28.11.2011)
- (25) **Filing Language:** English
- (26) **Publication Language:** English
- (30) **Priority Data:**
61/418,417 1 December 2010 (01.12.2010) US
61/423,589 16 December 2010 (16.12.2010) US
10-2011-0072845 22 July 2011 (22.07.2011) KR
- (71) **Applicant (for all designated States except US):** **LG ELECTRONICS INC.** [KR/KR]; 20 Yeouido-dong, Yeongdeungpo-gu, Seoul 150-721 (KR).
- (72) **Inventors; and**
- (75) **Inventors/Applicants (for US only):** **LEE, Dae Won** [KR/KR]; LG R&D Complex, 533 Hoge 1-dong, Dongan-gu, Anyang-si, Gyeonggi-do 431-749 (KR). **SOHN, Ill Soo** [KR/KR]; LG R&D Complex, 533 Hoge 1-dong, Dongan-gu, Anyang-si, Gyeonggi-do 431-749 (KR). **SEOK, Yong Ho** [KR/KR]; LG R&D Complex, 533 Hoge 1-dong, Dongan-gu, Anyang-si, Gyeonggi-do 431-749 (KR).
- (74) **Agent:** **YANG, Moon Ock**; Essen Patent & Law Firm, 2F, Samheung Yeoksam Bldg., 735-10 Yeoksam-dong, Gangnam-gu, Seoul 135-080 (KR).

- (81) **Designated States (unless otherwise indicated, for every kind of national protection available):** AE, AG, AL, AM, AO, AT, AU, AZ, BA, BB, BG, BH, BR, BW, BY, BZ, CA, CH, CL, CN, CO, CR, CU, CZ, DE, DK, DM, DO, DZ, EC, EE, EG, ES, FI, GB, GD, GE, GH, GM, GT, HN, HR, HU, ID, IL, IN, IS, JP, KE, KG, KM, KN, KP, KZ, LA, LC, LK, LR, LS, LT, LU, LY, MA, MD, ME, MG, MK, MN, MW, MX, MY, MZ, NA, NG, NI, NO, NZ, OM, PE, PG, PH, PL, PT, QA, RO, RS, RU, RW, SC, SD, SE, SG, SK, SL, SM, ST, SV, SY, TH, TJ, TM, TN, TR, TT, TZ, UA, UG, US, UZ, VC, VN, ZA, ZM, ZW.
- (84) **Designated States (unless otherwise indicated, for every kind of regional protection available):** ARIPO (BW, GH, GM, KE, LR, LS, MW, MZ, NA, RW, SD, SL, SZ, TZ, UG, ZM, ZW), Eurasian (AM, AZ, BY, KG, KZ, MD, RU, TJ, TM), European (AL, AT, BE, BG, CH, CY, CZ, DE, DK, EE, ES, FI, FR, GB, GR, HR, HU, IE, IS, IT, LT, LU, LV, MC, MK, MT, NL, NO, PL, PT, RO, RS, SE, SI, SK, SM, TR), OAPI (BF, BJ, CF, CG, CI, CM, GA, GN, GQ, GW, ML, MR, NE, SN, TD, TG).

Published:

- with international search report (Art. 21(3))
- before the expiration of the time limit for amending the claims and to be republished in the event of receipt of amendments (Rule 48.2(h))

(54) **Title:** METHOD FOR CHANNEL SOUNDING IN WIRELESS LOCAL AREA NETWORK AND APPARATUS FOR THE SAME

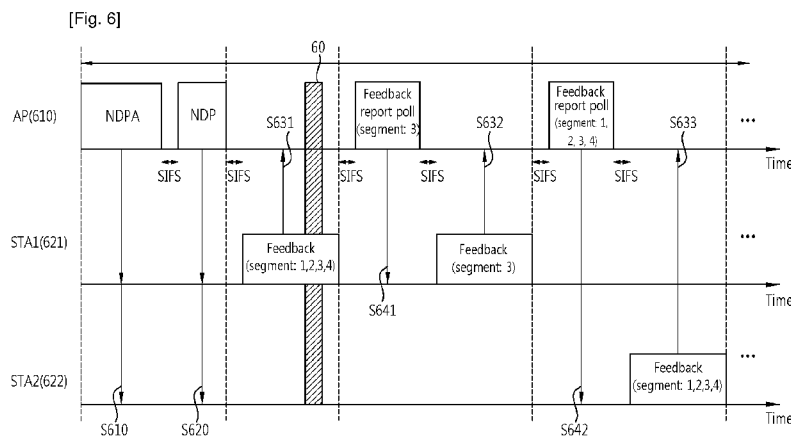

(57) **Abstract:** A channel sounding method in a wireless local area network (WLAN) system is provided. The method, performed by a transmitter, includes transmitting a null data packet announcement (NDPA) frame to a receiver to initiate a channel sounding procedure; transmitting a null data packet (NDP) to the receiver and receiving a feedback frame. The feedback frame includes a plurality of segment frames and a channel feedback report. The channel feedback report is split into a plurality of feedback segments. Each of the plurality of feedback segments is respectively included in each of the plurality of segment frames. The each of the plurality of segment frames includes a first-segment subfield indicating whether the each of the plurality of feedback segment included is a first segment and a remaining-segment subfield indicating the number of remaining feedback segments.

WO 2012/074251 A1

Description

Title of Invention: METHOD FOR CHANNEL SOUNDING IN WIRELESS LOCAL AREA NETWORK AND APPARATUS FOR THE SAME

Technical Field

[0001] The present invention relates to a wireless local area network (WLAN) system, and more particularly, to a channel sounding procedure between stations (STAs) in the WLAN system and an apparatus for supporting the procedure.

Background Art

[0002] With the advancement of information communication technologies, various wireless communication technologies have recently been developed. Among the wireless communication technologies, a wireless local area network (WLAN) is a technology whereby Internet access is possible in a wireless fashion in homes or businesses or in a region providing a specific service by using a portable terminal such as a personal digital assistant (PDA), a laptop computer, a portable multimedia player (PMP), etc.

[0003] The IEEE 802.11n is a technical standard relatively recently introduced to overcome a limited data rate which has been considered as a drawback in the WLAN. The IEEE 802.11n is devised to increase network speed and reliability and to extend an operational distance of a wireless network. More specifically, the IEEE 802.11n supports a high throughput (HT), i.e., a data processing rate of up to above 540 Mbps, and is based on a multiple input and multiple output (MIMO) technique which uses multiple antennas in both a transmitter and a receiver to minimize a transmission error and to optimize a data rate.

[0004] With the widespread use of the WLAN and the diversification of applications using the WLAN, there is a recent demand for a new WLAN system to support a higher throughput than a data processing rate supported by the IEEE 802.11n. A next-generation WLAN system supporting a very high throughput (VHT) is a next version of the IEEE 802.11n WLAN system, and is one of IEEE 802.11 WLAN systems which have recently been proposed to support a data processing rate of above 1 Gbps in a MAC service access point (SAP).

[0005] The next-generation WLAN system supports the transmission of a Multi-User Multiple Input Multiple Output (MU-MIMO) scheme in which a plurality of non-AP STAs accesses a radio channel at the same time in order to efficiently use the radio channel. According to the MU-MIMO transmission scheme, an AP can transmit a frame to one or more MIMO-paired STAs at the same time.

[0006] The AP and the plurality of MU-MIMO paired STAs may have different capabilities.

In this case, a supportable bandwidth, modulation coding scheme (MCS), forward error correction (FEC), etc., may vary depending on an STA type, usage, channel environment, etc.

[0007] In the WLAN system, an AP and/or an STA can acquire information on a channel to be used to transmit a frame to a reception target AP and/or STA. This can be performed by using a channel sounding procedure. That is, a process in which a transmitter requests a receiver to send channel information to be used for frame transmission and reception and the receiver estimates a channel and feeds back channel information thereof to the transmitter can be performed before transmitting and receiving a data frame. Meanwhile, since the next generation WLAN system employs a wider channel bandwidth and a MU-MIMO transmission scheme, a more amount of channel information can be received from a transmission target AP and/or STA. In order to transmit a more amount of feedback information, the transmission target AP and/or STA needs to access to a channel for a longer period of time. When interference occurs in a part of the feedback information transmitted and received during this period, there is a need to discard whole feedback information and thus new feedback information is necessary. This may cause deterioration in terms of efficiency of resource usage and reliability of a channel sounding procedure. Accordingly, there is a need for a channel sounding method capable of solving the aforementioned problem in a next generation WLAN system.

Summary of Invention

Technical Problem

[0008] The present invention provides a sounding method performed by a station (STA) in a next generation wireless local area network (WLAN) system supporting a multi user-multiple input multiple output (MU-MIMO) transmission scheme.

Solution to Problem

[0009] In an aspect, a channel sounding method in a wireless local area network (WLAN) system is provided. The method, performed by a transmitter, includes transmitting a null data packet announcement (NDPA) frame to a receiver to initiate a channel sounding procedure; transmitting a null data packet (NDP) to the receiver and receiving a feedback frame. The feedback frame includes a plurality of segment frames and a channel feedback report. The channel feedback report is split into a plurality of feedback segments. Each of the plurality of feedback segments is respectively included in each of the plurality of segment frames. The each of the plurality of segment frames includes a first-segment subfield indicating whether the each of the plurality of feedback segment included is a first segment and a remaining-segment subfield indicating the number of remaining feedback segments.

- [0010] The method may further include determining whether at least one feedback segment is missed on the basis of the first-segment subfield and the remaining-segment subfield and transmitting retransmission request information for the missed feedback segment, when a missed feedback segment is detected.
- [0011] The plurality of feedback segments may be equal in size except for a last feedback segment.
- [0012] The feedback frame may be an aggregate medium access control (MAC) protocol data unit (A-MPDU) transported as a data unit managed in a physical layer, and the segment frame is a MAC protocol data unit (MPDU) which is mutually exchanged in a MAC entity of the WLAN system.
- [0013] If a size of the channel feedback report is greater than or equal to a specific value, the channel feedback report may be split into the plurality of feedback segments.
- [0014] The channel feedback report may include feedback information used by the transmitter to determine a steering matrix.
- [0015] The channel feedback report may further include feedback information for a signal to ratio (SNR) for each spatial stream.
- [0016] The retransmission request information may be a bitmap sequence in which a bit value corresponding to an index of the missed feedback segment is set to 1.
- [0017] The method may further include receiving the missed feedback segment from the receiver.
- [0018] In another aspect, a channel sounding method in a WLAN system is provided. The method, performed by a receiver, includes receiving an NDPA frame transmitted by a transmitter to initiate a channel sounding procedure, generating a feedback frame including a channel feedback report and transmitting the feedback frame to the transmitter. The NDPA frame includes an identifier of the receiver. The generating of the feedback frame includes splitting the channel feedback report into a plurality of feedback segments and generating the feedback frame by including a plurality of segment frames in the feedback frame. Each of the plurality of segment frames respectively includes each of the plurality of feedback segments, a first-segment subfield indicating whether the each of the plurality of feedback segments included is a first segment and a remaining-segment subfield indicating the number of remaining feedback segment.
- [0019] In still another aspect, a wireless apparatus is provided. The apparatus includes a transceiver transmitting and receiving a frame and a processor operationally coupled to the transceiver. The processor is configured for: transmitting a null data packet announcement (NDPA) frame to a receiver to initiate a channel sounding procedure; transmitting a null data packet (NDP) to the receiver; and receiving a feedback frame. The feedback frame includes a plurality of segment frames and a channel feedback

report. The channel feedback report is split into a plurality of feedback segments. Each of the plurality of feedback segments is respectively included in each of the plurality of segment frames. The each of the plurality of segment frames includes a first-segment subfield indicating whether the each of the plurality of feedback segment included is a first segment and a remaining-segment subfield indicating the number of remaining feedback segments.

Advantageous Effects of Invention

[0020] According to a channel sounding procedure of the present invention, a channel bandwidth of a wideband and channel information increased due to the support of a multi user-multiple input multiple output (MU-MIMO) transmission scheme are separately transmitted. In doing so, even if a part of full channel information to be fed back is lost, the remaining parts can be utilized as normal channel information, thereby increasing reliability of frame transmission.

[0021] In addition, when the part of the full channel information to be fed back is lost, retransmission can be requested for the channel information and thus retransmission can be performed in response thereto. In doing so, a time required for unnecessarily accessing to a channel for the channel sounding procedure can be reduced, thereby increasing efficiency of a channel sounding method and improving a throughput of an overall wireless location area network (WLAN).

Brief Description of Drawings

[0022] FIG. 1 is a diagram showing the configuration of a WLAN system to which embodiments of the present invention may be applied.

[0023] FIG. 2 shows an example of a PPDU format according to an embodiment of the present invention.

[0024] FIG. 3 is a diagram showing a channel sounding method using an NDP in a next generation WLAN system.

[0025] FIG. 4 shows an example of corruption occurrence in a part of receiving signal.

[0026] FIG. 5 shows an example of a feedback frame applicable to an embodiment of the present invention.

[0027] FIG. 6 shows an example of a channel sounding method according to an embodiment of the present invention.

[0028] FIG. 7 is a diagram showing a format of a feedback control field that can be included in a segment feedback frame according to an embodiment of the present invention.

[0029] FIG. 8 is a diagram showing a channel information field format that can be included in a segment feedback frame according to an embodiment of the present invention.

[0030] FIG. 9 shows a conceptual location of a subcarrier tone to be fed back according to an embodiment of the present invention.

[0031] FIG. 10 shows an example of an NDPA frame format according to an embodiment of the present invention.

[0032] FIG. 11 is a block diagram showing a wireless apparatus to which an embodiment of the present invention is applicable.

Mode for the Invention

[0033] FIG. 1 is a diagram showing the configuration of a WLAN system to which embodiments of the present invention may be applied.

[0034] Referring to FIG. 1, A WLAN system includes one or more Basic Service Set (BSSs). The BSS is a set of stations (STAs) which can communicate with each other through successful synchronization. The BSS is not a concept indicating a specific area

[0035] An infrastructure BSS includes one or more non-AP STAs STA1, STA2, STA3, STA4, and STA5, an AP (Access Point) providing distribution service, and a Distribution System (DS) connecting a plurality of APs. In the infrastructure BSS, an AP manages the non-AP STAs of the BSS.

[0036] On the other hand, an Independent BSS (IBSS) is operated in an Ad-Hoc mode. The IBSS does not have a centralized management entity for performing a management function because it does not include an AP. That is, in the IBSS, non-AP STAs are managed in a distributed manner. In the IBSS, all STAs may be composed of mobile STAs. All the STAs form a self-contained network because they are not allowed to access the DS.

[0037] An STA is a certain functional medium, including Medium Access Control (MAC) and wireless-medium physical layer interface satisfying the Institute of Electrical and Electronics Engineers (IEEE) 802.11 standard. Hereinafter, the STA refers to both an AP and a non-AP STA.

[0038] A non-AP STA is an STA which is not an AP. The non-AP STA may also be referred to as a mobile terminal, a wireless device, a wireless transmit/receive unit (WTRU), a user equipment (UE), a mobile station (MS), a mobile subscriber unit, or simply a user. For convenience of explanation, the non-AP STA will be hereinafter referred to the STA.

[0039] The AP is a functional entity for providing connection to the DS through a wireless medium for an STA associated with the AP. Although communication between STAs in an infrastructure BSS including the AP is performed via the AP in principle, the STAs can perform direct communication when a direct link is set up. The AP may also be referred to as a central controller, a base station (BS), a node-B, a base transceiver system (BTS), a site controller, etc.

[0040] A plurality of infrastructure BSSs including the BSS shown in FIG. 1 can be interconnected by the use of the DS. An extended service set (ESS) is a plurality of BSSs

connected by the use of the DS. APs and/or STAs included in the ESS can communicate with each another. In the same ESS, an STA can move from one BSS to another BSS while performing seamless communication.

- [0041] In a WLAN system based on IEEE 802.11, a basic access mechanism of a medium access control (MAC) is a carrier sense multiple access with collision avoidance (CSMA/CA) mechanism. The CSMA/CA mechanism is also referred to as a distributed coordinate function (DCF) of the IEEE 802.11 MAC, and basically employs a "listen before talk" access mechanism. In this type of access mechanism, an AP and/or an STA senses a wireless channel or medium before starting transmission. As a result of sensing, if it is determined that the medium is in an idle status, frame transmission starts by using the medium. Otherwise, if it is sensed that the medium is in an occupied status, the AP and/or the STA does not start its transmission but sets and waits for a delay duration for medium access.
- [0042] The CSMA/CA mechanism also includes virtual carrier sensing in addition to physical carrier sensing in which the AP and/or the STA directly senses the medium. The virtual carrier sensing is designed to compensate for a problem that can occur in medium access such as a hidden node problem. For the virtual carrier sensing, the MAC of the WLAN system uses a network allocation vector (NAV). The NAV is a value transmitted by an AP and/or an STA, currently using the medium or having a right to use the medium, to another AP or another STA to indicate a remaining time before the medium returns to an available state. Therefore, a value set to the NAV corresponds to a period reserved for the use of the medium by an AP and/or an STA transmitting a corresponding frame.
- [0043] The AP and/or the STA may perform a procedure of exchanging a request to send (RTS) frame and a clear to send (CTS) frame to announce that it intends to access a medium. The RTS frame and the CTS frame include information indicating a time duration reserved for access of a radio medium required to transmit and receive an acknowledgement (ACK) frame when an actual data frame transmission and reception ACK is supported. Upon receiving an RTS frame transmitted from an AP and/or an STA intending to transmit a frame or upon receiving a CTS frame transmitted from a frame transmission target STA, another STA can be configured not to access to the medium for the time duration indicated by the information included in the RTS/CTS frame. This can be implemented by configuring an NAV for the time duration.
- [0044] Unlike the conventional WLAN system, the next generation WLAN system requires a higher throughput. This is called a very high throughput (VHT). For this, the next generation WLAN system intends to support 80MHz, contiguous 160MHz, non-contiguous 160MHz bandwidth transmission and/or higher bandwidth transmission. In addition, a multi user-multiple input multiple output (MU-MIMO) transmission

scheme is provided for the higher throughput. In the next generation WLAN system, an AP can transmit a data frame simultaneously to at least one or more MIMO-paired STAs. In the WLAN system of FIG. 1, an AP 10 can transmit data simultaneously to an STA group including at least one or more STAs among a plurality of STAs 21, 22, 23, 24, and 30 associated with the AP 10. In this case, data transmitted to each STA can be transmitted through different spatial streams. A data frame transmitted by the AP 10 can be referred to as a physical layer convergence procedure (PLCP) protocol data unit (PPDU) generated and transmitted in a physical layer (PHY) of the WLAN system. It is assumed in the embodiment of the present invention that a transmission target STA group which is MU-MIMO paired with the AP 10 is the STA1 21, the STA2 22, the STA3 23, and the STA4 24. In this case, the spatial stream may not be allocated to a specific STA in the transmission target STA group and thus data may not be transmitted. Meanwhile, it is assumed that the STAa 30 is an STA which is associated with the AP but is not included in the transmission target STA group.

[0045] FIG. 2 shows an example of a PPDU format according to an embodiment of the present invention.

[0046] Referring to FIG. 2, a PPDU 200 includes an L-STF field 210, an L-LTF field 220, an L-SIG field 230, a VHT-SIGA field 240, a VHT-STF field 250, a VHT-LTF field 260, a VHT-SIGB field 270, and a data field 280.

[0047] A PLCP sub-layer constituting a PHY converts a PLCP service data unit(PSDU) delivered from a MAC layer into the data field 280 by appending necessary information to the PSDU, generates the PPDU 200 by appending several fields such as the L-STF field 210, the L-LTF field 220, the L-SIG field 230, the VHT-SIGA field 240, the VHT-STF field 250, the VHT-LTF field 260, the VHT-SIGB field 270, or the like, and delivers the PPDU 200 to one or more STAs through a physical medium dependent (PMD) sub-layer constituting the PHY.

[0048] The L-STF field 210 is used for frame timing acquisition, automatic gain control (AGC) convergence, coarse frequency acquisition, etc.

[0049] The L-LTF field 220 is used for channel estimation for demodulation of the L-SIG field 230 and the VHT-SIGA field 240.

[0050] The L-SIG field 230 is used when an L-STA receives the PPDU to acquire data.

[0051] The VHT-SIGA field 240 includes control information for interpreting the received PPDU 200 as common control information required for VHT-STAs which are MIMO-paired with an AP. The VHT-SIGA field 240 includes information on a spatial stream for each of the plurality of MIMO-paired STAs, bandwidth information, identification information regarding whether space time block coding (STBC) is used, a group identifier for a transmission target STA group, information regarding a spatial stream allocated to an STA included in a transmission target group STA indicated by the

group identifier, information regarding a short guard interval (GI) of the transmission target STA, coding information, modulation and coding scheme (MCS) information, information indicating whether beamforming is performed, and CRC related information. Herein, the group identifier may include whether a currently used MIMO transmission method is MU-MIMO or SU-MIMO. The VHT-SIGA field 240 may be transmitted by using two OFDM symbols. In this case, a field related to a symbol that comes first can be referred to as a VHT-SIGA1, and a field related to a subsequent symbol can be referred to as a VHT-SIGA2 field.

- [0052] The VHT-STF field 250 is used to improve performance of AGC estimation in MIMO transmission.
- [0053] The VHT-LTF field 260 is used when the STA estimates a MIMO channel. Since the next generation WLAN system supports MU-MIMO, the VHT-LTF field 260 can be configured by the number of spatial streams on which the PPDU 200 is transmitted. In addition, when full channel sounding is supported and is performed, the number of VHT-LTFs may increase.
- [0054] The VHT-SIGB field 270 includes dedicated control information required when the plurality of MIMO-paired STAs receive the PPDU 200 to acquire data. Therefore, the STA may be designed such that the VHT-SIGB field 270 is decoded only when the common control information included in the VHT-SIGB field 270 indicates that the currently received PPDU 200 is transmitted using MU-MIMO transmission. On the contrary, the STA may be designed such that the VHT-SIGB field 270 is not decoded when the common control information indicates that the currently received PPDU 200 is for a single STA (including SU-MIMO).
- [0055] The VHT-SIGB field 270 includes length information of a PSDU included in the data field transmitted to each STA, MSC information, and tail related information included in the data field. Further, the VHT-SIGB field 270 includes information on encoding and rate-matching. A size of the VHT-SIGB field 270 may differ according to the MIMO transmission method (MU-MIMO or SU-MIMO) and a channel bandwidth used for PPDU transmission.
- [0056] The data field 280 includes data intended to be transmitted to the STA. The data field 280 includes a service field for initializing a scrambler and a PLCP service data unit (PSDU) to which a MAC protocol data unit (MPDU) of a MAC layer is delivered, a tail field including a bit sequence required to reset a convolution encoder to a zero state, and padding bits for normalizing a length of the data field.
- [0057] In the WLAN system of FIG. 1, if the AP 10 intends to transmit data to the STA1 21, the STA2 22, and the STA3 23, then a PPDU may be transmitted to an STA group including the STA1 21, the STA2 22, the STA3 23, and the STA4 24. In this case, as shown in FIG. 2, no spatial stream may be allocated to the STA4 24, and a specific

number of spatial streams may be allocated to each of the STA1 21, the STA2 22, and the STA3 23 and then data can be transmitted according thereto. In the example of FIG. 2, one spatial stream is allocated to the STA1 21, three spatial streams are allocated to the STA2 22, and two spatial streams are allocated to the STA3 23.

- [0058] One of the most significant features of the next generation WLAN system is that an overall system throughput can be improved according to a MU-MIMO transmission scheme in which several spatial streams are transmitted to a plurality of STAs by using multiple antennas. In a situation where the plurality of STAs are present, an AP intending to perform data transmission transmits a PPDU through a beamforming procedure to transmit data to a transmission target STA group. Therefore, since an AP and/or an STA intending to transmit the PPDU requires channel information for each transmission target STA, a channel sounding procedure is necessary to acquire the channel information.
- [0059] Two schemes are supported for the channel sounding procedure. One is a scheme based on a normal PPDU including a data field, and the other is a scheme based on a null data packet (NDP) not including the data field. Hereinafter, the NDP may also be referred to as a sounding frame.
- [0060] FIG. 3 is a diagram showing a channel sounding method using an NDP in a next generation WLAN system. In this embodiment, an AP performs channel sounding on three transmission target STAs in order to transmit data to the three transmission target STAs. However, the AP may perform channel sounding on one STA.
- [0061] Referring to FIG. 3, an AP 310 transmits an NDP announcement (NDPA) frame to an STA1 321, an STA2 322, and an STA3 323 (step S310). The NDPA frame is for announcing information for identifying an STA for transmitting a feedback frame in response to an NDP transmitted subsequently. The AP 310 transmits the NDPA frame by inserting an STA information field including information on a sounding target STA into the NDPA frame. One STA information field may be included for each sounding target STA. The NDPA frame can be referred to as a sounding announcement frame.
- [0062] As shown in FIG. 3, the AP 310 broadcasts the NDPA frame if the NDPA frame is transmitted to at least one sounding target STA for MU-MIMO channel sounding. On the other hand, if the NDPA frame is intended to be transmitted to one sounding target STA for SU-MIMO channel sounding, recipient address information included in the NDPA frame may be transmitted in a unicast manner by configuring it as a MAC address of the sounding target STA.
- [0063] Table 1 below shows an example of an STA information field format included in the NDPA frame.
- [0064]

[Table 1]

[Table]

AID	Contain AID of sounding target STA
Feedback Type	Indicate feedback request type for sounding target STA Set to 0 for SU-MIMO Set to 1 for MU-MIMO
Nc Index	Indicate requested feedback dimension In case of MU-MIMO: Set to 0 if Nc = 1 Set to 1 if Nc = 2 Set to 2 if Nc = 3 Set to 3 if Nc = 4 Set to 4 if Nc = 5 Set to 5 if Nc = 6 Set to 6 if Nc = 7 Set to 7 if Nc = 8 In case of SU-MIMO, used as a reserved subfield (set to 1)

[0065] In Table 1 above, Nc denotes the number of columns of beamforming feedback matrices among a plurality of pieces of feedback information transmitted by the sounding target STA to the AP in response to a received NDP.

[0066] Upon receiving the NDPA frame, STAs may confirm an AID subfield value included in the STA information field, and may determine whether the STAs are sounding target STAs. In the embodiment of FIG. 3, the NDPA frame may include an STA information field including an AID of the STA1 321, an STA information field including an AID of the STA2 322, and an STA information field including an AID of the STA3 323.

[0067] Subsequent to NDPA frame transmission, the AP 310 transmits an NDP to the sounding target STA (step S320). The NDP may have a format obtained by excluding a data field from the PPDU format of FIG. 2. The NDP frame is subjected to beamforming by the AP 310, and is transmitted to the sounding target STA by using at least one or more spatial streams. Therefore, sounding target STAs 321, 322, and 323 may estimate channels on the basis of a VHT-LTF of the NDP.

[0068] As control information included in the NDP in NDP transmission, length information indicating a length of a PSDU included in the data field or a length of an aggregate-MAC protocol data unit (A-MPDU) included in the PSDU is set to 0, and information

indicating the number of transmission target STAs is set to 1. A group ID indicating whether a transmission scheme used for NDP transmission is MU-MIMO or SU-MIMO and indicating a transmission target STA group is set to a value indicating SU-MIMO transmission. Information indicating the number of spatial streams allocated to the transmission target STA is set to a value corresponding to the number of spatial streams transmitted to the transmission target STA through MU-MIMO or SU-MIMO. Channel bandwidth information used for NDP transmission may be set to a bandwidth value used for transmission of the NDPA frame.

- [0069] The STA1 321 transmits a feedback frame to the AP 310 (step S331). The channel bandwidth information used for transmission of the feedback frame may be set to a value less than or equal to a channel bandwidth used for transmission of the NDPA frame.
- [0070] The AP 310 transmits a feedback poll frame to the STA2 322 after receiving the feedback frame from the STA1 321 (step S341). The feedback poll frame is a frame for requesting the receiving STA to transmit the feedback frame. The feedback poll frame is transmitted in a unicast manner to an STA to which transmission of the feedback frame will be requested. Upon receiving the feedback poll frame, the STA2 322 transmits the feedback frame to the AP 310 (step S332). Subsequently, the AP 310 transmits the feedback poll frame to the STA3 323 (step S342). The STA3 323 transmits the feedback frame to the AP 310 in response to the feedback poll frame (step S333).
- [0071] Various channel bandwidths may be used to transmit data in the WLAN system. In order to estimate channels for the various bandwidths, channel information for the various bandwidths may be fed back. The next generation WLAN system supports bandwidths of 20MHz, 40MHz, 80MHz, contiguous 160MHz, and non-contiguous 160(80+80)MHz. Therefore, since channel information for each bandwidth is fed back, an amount of channel feedback information may increase.
- [0072] In the present invention, channel information based on channel estimation performed by an STA is transmitted by being included in a feedback frame transmitted from the STA to an AP. The feedback frame includes a channel information field and a channel information control field. Table 2 and Table 3 below show formats of the channel information control field and the channel information field.
- [0073]

[Table 2]

[Table]

Subfield	Description
Nc Index	Indicate the number of columns of a beamforming feedback matrix 0 if $N_c = 1$ 1 if $N_c = 2$... 7 if $N_c = 8$
Nc Index	Indicate the number of rows of a beamforming feedback matrix 0 if $N_r = 1$ 1 if $N_r = 2$... 7 if $N_r = 8$
channel bandwidth	Indicate a bandwidth of an estimated channel 0 if 20MHz 1 if 40MHz 2 if 80MHz 3 if 160MHz or 80+80MHz
grouping, N_g	The number of carriers for grouping 0 if $N_g=1$ 1 if $N_g=2$ 2 if $N_g=4$ (3 is reserved)
codebook in-formation	Indicate a size of codebook entries
MU-scheme	Indicate whether beamforming feedback is for SU-MIMO or MU-MIMO
sounding sequence	A sequence number from an NDPA that requests feedback

[0074]

[0075]

[Table 3]

[Table]

Subfield	Description
SNR(signal to noise ratio) of spatial stream 1	average SNR on subcarriers in a recipient for a first spatial stream
...	...
SNR of spatial stream Nc	average SNR on subcarriers in a recipient for an Nc th spatial stream
beamforming feedback matrix (subcarrier index 0)	order of an angle of a beamforming feedback matrix for a corresponding subcarrier
beamforming feedback matrix (subcarrier index 1)	order of an angle of a beamforming feedback matrix for a corresponding subcarrier
...	...
beamforming feedback matrix (subcarrier index Ns)	order of an angle of a beamforming feedback matrix for a corresponding subcarrier

[0076] Information of the channel information field disclosed in Table 3 can be interpreted based on information included in the channel control field disclosed in Table 2.

[0077] In the next generation WLAN system, the MU-MIMO transmission scheme is supported and thus more channels are present between an AP and a plurality of MU-MIMO paired STAs. Further, since a channel bandwidth of a broader band is supported to increase a throughput, an amount of channel information to be fed back by the STA can be significantly increased. For example, an interference signal may be received in a part of time duration in a process of transmitting SNR information for 8 spatial streams and transmitting feedback information corresponding to 160MHz bandwidth, and corruption may occur in a part which is intended to be normally received in the time duration. An example thereof can be found in FIG. 4.

[0078] If all feedback frames are subjected to error detection by using the same checksum, there is no way for a recipient of the feedback frames to determine at which part an error occurs, which leads to a state where the whole feedback frame has to be discarded. In addition, a transmitter of the feedback frame transmits again the feedback frame by including large-sized channel information. For this, a channel is occupied, and thus overall throughput of the WLAN system may deteriorate.

[0079] If a great amount of channel information has to be fed back as described above, it is proposed to segment the channel information on a bandwidth or a spatial stream basis and transmit the segmentations by considering them as respective feedback units.

Although the channel information is segmented on the bandwidth basis in a method to be described hereinafter, the present invention is also applicable when the channel information is segmented on the spatial stream basis.

[0080] In a case where a data sequence to be transmitted becomes too long, the data sequence can be segmented and thus can be transmitted in a data unit. However, if channel information to be fed back is segmented on any bit basis, a specific feedback unit itself is not self-decodable, and can be decoded and utilized as understandable information only when previous bit information is known. To avoid such a problem, there is a need to perform segmentation on a specific bandwidth or spatial stream basis so that each segment itself is decodable. For example, when channel information per bandwidth is fed back, the channel information can be segmented and then can be included in a plurality of data units, and the plurality of data units can be generated in an aggregated MAC protocol data unit (A-MPDU) and then the A-MPDU can be transmitted. In this case, each channel information is included in a MAC protocol data unit (MPDU) which is a data unit exchanged by a MAC entity, and the A-MPDU has a structure including a plurality of MPDUs and can be transmitted or transported as one PSDU which is a service data unit managed in a physical layer.

[0081] FIG. 5 shows an example of a feedback frame applicable to an embodiment of the present invention.

[0082] Referring to FIG. 5, a feedback frame 500 according to the embodiment of the present invention has an A-MPDU format, and can be transmitted in a PPDU format by appending a preamble and a PLCP header. The feedback frame 500 includes four sub-feedback frames 510, 520, 530, and 540. However, a specific number of subframes shown in FIG. 5 is for exemplary purposes only, and thus the number of subframes may be greater than or equal to 4 according to a size of channel information. Each sub-feedback frame may have an MPDU format. Each sub-feedback frame includes segment feedback channel information. The segment feedback channel information may be channel information for a specific spatial stream or channel information for a specific bandwidth. In the present embodiment, the segment feedback channel information implies channel information for a specific channel bandwidth. A plurality of pieces of segment feedback channel information may be configured to have the same amount except for a last segment.

[0083] Referring to FIG. 5, since an interference signal is detected together at a time of receiving the sub-feedback frame #4 540, the AP is unable to normally acquire 4th segment feedback information. According to the conventional channel sounding method, retransmission is requested for whole feedback channel information when a part of the feedback channel information is not correctly received due to a reception signal interference. On the other hand, when a sounding target STA segments the

feedback channel information and transmits it in an A-MPDU format according to the embodiment of the present invention, even if a signal interference acts on a part of the feedback channel information, retransmission may be requested for segment feedback channel information including that part. This can be performed by a method of transmitting a report poll frame to an STA in order to retransmit specific segment feedback channel information.

[0084] FIG. 6 shows an example of a channel sounding method according to an embodiment of the present invention.

[0085] Referring to FIG. 6, an AP 610 transmits an NDPA frame to an STA1 621 and an STA2 622 (step S610). The NDPA frame is for announcing information identifying an STA for transmitting a feedback frame before NDP transmission. The AP 610 transmits the NDPA frame by inserting STA information field including information on sounding target STAs, i.e., STA1 621 and STA2 622, into the NDPA frame. A format of the STA information field included in the NDPA frame and included information are as shown in the STA information field described with reference to FIG. 3.

[0086] Subsequent to transmission of the NDPA frame, the AP 610 transmits an NDP frame to the STA1 621 and the STA2 622 (step S620). The NDP is subjected to be beamformed by the AP 610, and is transmitted to the STA1 621 and the STA2 622 by using at least one or more spatial streams. Therefore, the STA1 621 and the STA2 622 may estimate channels by using a VHT-LTF of the NDP. A plurality of pieces of control information included in the NDP are the same as those of the NDP described with reference to FIG. 3.

[0087] The STA1 621 transmits a feedback frame to the AP 610 (step S631). Channel bandwidth information used for transmission of the feedback frame can be configured to have a bandwidth narrower than or equal to a channel bandwidth used for transmission of the NDPA frame. A format of the feedback frame includes four sub-feedback frames including segment feedback information similarly to the feedback frame format of FIG. 5.

[0088] The sub-feedback frame to be transmitted by being included in the feedback frame is transmitted by including one piece of segment feedback channel information, and when transmitting feedback channel information for a wide bandwidth, it can be transmitted by using several pieces of segment feedback channel information. In this case, in order to make the segment feedback information self-understandable/decodable, the feedback information is transmitted by further including control information required to interpret the segment feedback channel information for each piece of segment feedback channel information. This will be described in greater detail with reference to FIG. 7 and FIG. 8.

- [0089] FIG. 7 is a diagram showing a format of a feedback control field that can be included in a segment feedback frame according to an embodiment of the present invention. A segment feedback control field includes control information required to interpret segment feedback information included in the segment feedback frame.
- [0090] Referring to FIG. 7, a feedback control field 700 includes an Nc index subfield 710, an Nr index subfield 720, a channel bandwidth subfield 730, a grouping subfield 740, a codebook information subfield 750, a multi user (MU)-type subfield 760, a segment information subfield 770, and a sounding sequence subfield 780. The subfields other than the segment information subfield 770 include information of Table 2, and can be configured depending on the information.
- [0091] The segment information subfield 770 includes information indicating to which segment the segment feedback information belongs. The segment information subfield includes a remaining-segment subfield 771 and a first-segment subfield 772.
- [0092] The remaining-segment subfield 771 includes information indicating the number of pieces of remaining-segment feedback channel information in an associated feedback frame. For example, if a currently confirmed remaining-segment subfield value is 5, five pieces of feedback channel information are more present. When a segmented feedback frame is transmitted or when a non-segmented feedback frame is transmitted, the remaining-segment subfield 771 is set to '0' when transmitted. When the segment feedback channel information is retransmitted, the remaining-segment subfield 771 can be set to the same value which is set for the segment feedback channel information in original transmission.
- [0093] The first-segment subfield 772 may be set to '1' if specific segment feedback channel information of the segmented feedback frame corresponds to a first segment or if a non-segmented feedback frame is transmitted, and may be set to '0' in other cases. When segment feedback channel information is retransmitted, the first-segment subfield 772 may be set to be equal to a value which is set for the segment feedback channel information in original transmission.
- [0094] Upon receiving a sub-feedback frame, the AP can know a specific order of segment feedback channel information included in the frame by using values which are set in the remaining-segment subfield 771 and the first-segment subfield 772, and can determine whether a specific segment feedback channel is normally received. For example, if a sub-feedback frame of which the first-segment subfield 772 is set to '1' is not successfully received, it can be determined that reception of first segment feedback channel information fails. In addition, values of the remaining-segment subfield 771 can be checked for to determine a presence or absence of missing segment feedback channel information according to whether the values are sequentially decreased from a specific number to zero.

- [0095] FIG. 8 is a diagram showing a channel information field format that can be included in a segment feedback frame according to an embodiment of the present invention. Segment feedback channel information transmitted by an STA is transmitted by being included in a channel information field.
- [0096] Referring to FIG. 8, a channel information field 800 includes a plurality of SNR subfields 810 indicating an average SNR value for a spatial stream and a feedback matrix subfield 820. Each SNR subfield indicates a recipient-side SNR value for a specific spatial stream or spatial stream set. The feedback matrix subfield 820 includes a feedback matrix related value as segment feedback information.
- [0097] Meanwhile, since one time transmission is enough for information indicating an SNR value for a spatial stream, it may be unnecessary to transmit the information by inserting it into each of a plurality of segment feedback frames. Therefore, a feedback frame can be configured such that a specific segment feedback frame includes an SNR subfield but other segment feedback frames do not include the SNR subfield. Alternatively, according to implementation, the SNR subframe can be included in all segment feedback frames when transmitted. This is because although the SNR subfield is included in one segment feedback frame when transmitted, a delay may occur until SNR information for each spatial stream is received again if an AP and/or a reception STA cannot normally receive the segment feedback frame.
- [0098] Referring back to FIG. 6, signal interference does not occur when the STA1 621 receives sub-feedback frames 1, 2, and 4, and thus decoding is normally performed and 1st, 2nd, and 4th pieces of segment feedback channel information are normally acquired. On the other hand, when receiving a sub-feedback frame 3, a signal interference 60 occurs and thus decoding cannot be normally performed on a 3rd sub-feedback frame, and eventually a 3rd piece of segment feedback channel information may not be acquired. Therefore, the AP 610 has to request the STA1 621 to retransmit the 3rd piece of segment feedback channel information which cannot be decoded since it fails to be received normally.
- [0099] The AP 610 transmits a feedback report poll frame to request the STA1 621 to retransmit the 3rd piece of segment channel feedback information (step S641). The feedback report poll frame transmitted by the AP 610 includes information indicating segment feedback channel information which is desired to be retransmitted. In particular, if indication information for requesting any segment feedback channel information among a plurality of pieces of segment feedback channel information is included, the indication information can be implemented in a bitmap format. For this, the feedback report poll frame may include a segment retransmission indication field. If a specific bit is set to '1' in a bit-stream constituting the segment retransmission indication field, it can be interpreted that retransmission of segment feedback channel in-

formation related to that bit is requested. However, it can be configured such that a value '0' implies a retransmission request. In the example of FIG. 6, the bit-stream constituting the segment retransmission indication field included in the feedback report poll frame transmitted by the AP 610 in step S641 can be set to '0 0 1 0'.

[0100] The STA1 621 may receive the feedback report poll frame and confirm a value of the segment retransmission indication field and thus may know that retransmission of the 3rd piece of segment feedback channel information is necessary. The STA1 621 transmits a feedback frame to the AP 610 in response to the feedback report poll frame (step S632). The feedback frame may include only the 3rd piece of segment feedback channel information which is retransmission target segment feedback channel information indicated by the segment retransmission indication field or may include all pieces of segment feedback channel information. The retransmitted feedback frame may include a feedback control field and a channel information field as shown in the format of FIG. 7 and FIG. 8.

[0101] The AP 610 receives the segment feedback channel information of which retransmission is requested from the STA1 621, and thereafter transmits a feedback report poll frame to the STA2 622 (step S642). Since the AP 610 has to request the STA2 622 to transmit the whole feedback channel information, the report poll frame may include a segment retransmission indication field which is configured to indicate the whole segment feedback channel information. As such, when performing a channel sounding method, if the AP 610 intends to acquire channel feedback information from an STA other than a target STA to which a feedback frame will be first transmitted, the feedback report poll frame including the segment retransmission indication field configured to indicate the entire segment feedback channel information can be transmitted to the STA.

[0102] The STA2 622 transmits to the AP 610 a feedback frame including channel estimation information in response to the report poll frame received from the AP 610 (step S633). The feedback frame transmitted by the STA2 622 may include the feedback control field and the channel information field as shown in the format of FIG. 7 and FIG. 8.

[0103] In the defining of the segment feedback information, the embodiment of the present invention proposes to additionally divide a bandwidth into 20MHz, 40MHz, or 80MHz.

[0104] FIG. 9 shows a conceptual location of a subcarrier tone to be fed back according to an embodiment of the present invention.

[0105] Referring to FIG. 9, feedback information of 80MHz may be divided by 20MHz to generate a plurality of pieces of segment feedback channel information, and a sub-feedback frame based on a MPDU format may be configured for each piece of segment

feedback channel information and then may be fed back in an A-MPDU format. A reference bandwidth used for segmentation may be not only 20MHz but also 40MHz or a specific bandwidth higher than 40MHz. When transmitting the feedback channel information by dividing the information in this manner, the segment feedback channel information needs to be indexed and indication information thereof needs to be provided.

- [0106] In addition, when an AP performs channel sounding on one STA, a report poll frame is not necessarily used to perform sounding, but a feedback matrix or feedback information such as a channel coefficient can be individually acquired by transmitting an NDPA frame and an NDP frame.
- [0107] In a case where specific segment feedback channel information is not normally received when receiving a feedback by attempting sounding one time, a method capable of selectively receiving the specific segment feedback channel information again by using the NDPA frame and the NDP frame is proposed.
- [0108] For this, information indicating that the specific segment feedback channel information will be selectively transmitted may be included in the NDPA frame when transmitted. As such, when retransmission of the segment feedback channel information is requested by reusing the NDPA frame and the NDP frame, since this is a case where retransmission is requested only for specific one STA, the STA information field of the NDPA frame may include only a field for one STA.
- [0109] In addition, when the AP performs channel sounding on a plurality of STAs, it is possible to request a specific STA to feed back only specific feedback channel information.
- [0110] FIG. 10 shows an example of an NDPA frame format according to an embodiment of the present invention.
- [0111] Referring to FIG. 10, an NDPA frame 1000 includes a frame control field 1010, a duration field 1020, a receiver address (RA) field 1030, a transmitter address (TA) field 1040, a sounding sequence field 1050, at least one or more STA information fields 1060, and an FCS field 1070.
- [0112] The frame control field 1010 includes control information for the NDPA frame 1000. The duration field 1020 includes length information of the NDPA frame 1000. The RA field 1030 can be set to a broadcast address, but if sounding is requested to one specific STA, can be set to a MAC address of the STA. The TA field 1040 can be set to a MAC address of an AP that transmits the NDPA frame 1000. The sounding sequence field 1050 is set to a sequence number for a current sounding sequence. The FCS field 1070 includes CRC related information for frame transmission and reception.
- [0113] An STA information field #1 1061 and an STA information field #2 1062 include AID subfields 1061a and 1062a indicating AIDs of sounding target STA1 and STA2,

feedback type subfields 1061b and 1062b indicating a feedback request type for the sounding target STA, and Nc index fields 1061c and 1062c indicating a feedback dimension. The number of STA information fields 1060 can change depending on the number of sounding target STAs, and sounding requested to two STAs in the present embodiment is for exemplary purposes only.

[0114] However, when the AP requests the STA1 to selectively retransmit segment feedback channel information, the STA information field 1060 for the STA1 may further include a segment retransmission indication subfield 1061d. The segment retransmission indication subfield 1061d can be configured similarly to the segment retransmission indication subfield included in the aforementioned report poll frame.

[0115] When the AP broadcasts an NDPA frame having the aforementioned frame format, the STA1 and the STA2 receive the NDPA frame 1000 and can know that it is an NDPA frame for the STA1 and the STA2 by using the AID subfields 1061a and 1062a of the STA information fields 1061 and 1062. Thereafter, when the AP sends the NDP frame, each feedback frame is transmitted to the AP, and in this case, the STA1 may feed back only segment feedback channel information indicated by the segment retransmission indication subfield 1061d included in the NDPA frame 1000.

[0116] FIG. 11 is a block diagram showing a wireless apparatus to which an embodiment of the present invention is applicable. The wireless apparatus may be an AP or an STA.

[0117] The wireless apparatus 1100 includes a processor 1110, memory 1120, and a transceiver 1130. The transceiver 1130 transmits and/or receives a radio signal and implements the physical layer of the IEEE 802.11 standard. The processor 1110 is operatively coupled to the transceiver 1130 and implements the MAC layer and the PHY layer of the IEEE 802.11 standard.

[0118] A processor 1110 can be configured to generate and transmit an NDPA frame, an NDP, and a feedback report poll frame proposed in the present invention, and can also be configured to receive the transmitted frame and interpret an included field value in order to acquire control information. In addition, the processor 1110 can be configured to transmit feedback channel information in association with request information included in the frame or can be configured to selectively transmit segment feedback channel information. The processor can be configured to implement the aforementioned embodiment of the present invention described with reference to FIG. 2 and FIG. 10.

[0119] The processor 1110 and/or the transceiver 1130 may include an application-specific integrated circuit (ASIC), a separate chipset, a logic circuit, and/or a data processing unit. When the embodiment of the present invention is implemented in software, the aforementioned methods can be implemented with a module (i.e., process, function, etc.) for performing the aforementioned functions. The module may be stored in the

memory 1120 and may be performed by the processor 1110. The memory 1120 may be located inside or outside the processor 1110, and may be coupled to the processor 1110 by using various well-known means.

[0120] Although the present invention has been particularly shown and described with reference to exemplary embodiments thereof, it will be understood by those skilled in the art that various changes in form and details may be made therein without departing from the spirit and scope of the invention as defined by the appended claims.

Claims

- [Claim 1] A channel sounding method in a wireless local area network (WLAN) system, the method comprising:
transmitting, by a transmitter, a null data packet announcement (NDPA) frame to a receiver to initiate a channel sounding procedure;
transmitting, by the transmitter, a null data packet (NDP) to the receiver; and
receiving, by the transmitter, a feedback frame ,
wherein the feedback frame includes a plurality of segment frames and a channel feedback report,
wherein the channel feedback report is split into a plurality of feedback segments,
wherein each of the plurality of feedback segments is respectively included in each of the plurality of segment frames,
wherein the each of the plurality of segment frames includes a first-segment subfield indicating whether the each of the plurality of feedback segment included is a first segment; and,
a remaining-segment subfield indicating the number of remaining feedback segments.
- [Claim 2] The method of claim 1, further comprising:
determining, by the transmitter, whether at least one feedback segment is missed on the basis of the first-segment subfield and the remaining-segment subfield; and,
transmitting, by the transmitter, retransmission request information for the missed feedback segment, when a missed feedback segment is detected.
- [Claim 3] The method of claim 2, wherein the plurality of feedback segments are equal in size except for a last feedback segment.
- [Claim 4] The method of claim 3, wherein the feedback frame is an aggregate medium access control (MAC) protocol data unit (A-MPDU) transported as a data unit managed in a physical layer, and the segment frame is a MAC protocol data unit (MPDU) which is mutually exchanged in a MAC entity of the WLAN system.
- [Claim 5] The method of claim 2, wherein if a size of the channel feedback report is greater than or equal to a specific value, the channel feedback report is split into the plurality of feedback segments.
- [Claim 6] The method of claim 2, wherein the channel feedback report includes

- feedback information used by the transmitter to determine a steering matrix.
- [Claim 7] The method of claim 6, wherein the channel feedback report further includes feedback information for a signal to ratio (SNR) for each spatial stream.
- [Claim 8] The method of claim 2, wherein the retransmission request information is a bitmap sequence in which a bit value corresponding to an index of the missed feedback segment is set to 1.
- [Claim 9] The method of claim 8, further comprising receiving, by the transmitter, the missed feedback segment from the receiver.
- [Claim 10] A channel sounding method in a WLAN system, the method comprising:
receiving, by a receiver, an NDPA frame transmitted by a transmitter to initiate a channel sounding procedure,
generating, by the receiver, a feedback frame including a channel feedback report; and
transmitting, by the receiver, the feedback frame to the transmitter, wherein the NDPA frame includes an identifier of the receiver;
wherein the generating of the feedback frame comprises:
splitting the channel feedback report into a plurality of feedback segments; and
generating the feedback frame by including a plurality of segment frames in the feedback frame,
wherein each of the plurality of segment frames respectively includes, each of the plurality of feedback segments;
a first-segment subfield indicating whether the each of the plurality of feedback segments included is a first segment; and,
a remaining-segment subfield indicating the number of remaining feedback segment.
- [Claim 11] A wireless apparatus comprising:
a transceiver transmitting and receiving a frame; and
a processor operationally coupled to the transceiver,
wherein the processor is configured for:
transmitting a null data packet announcement (NDPA) frame to a receiver to initiate a channel sounding procedure;
transmitting a null data packet (NDP) to the receiver; and
receiving a feedback frame ,
wherein the feedback frame includes a plurality of segment frames and

a channel feedback report,
wherein the channel feedback report is split into a plurality of feedback segments,
wherein each of the plurality of feedback segments is respectively included in each of the plurality of segment frames,
wherein the each of the plurality of segment frames includes a first-segment subfield indicating whether the each of the plurality of feedback segment included is a first segment; and,
a remaining-segment subfield indicating the number of remaining feedback segments.

[Fig. 1]

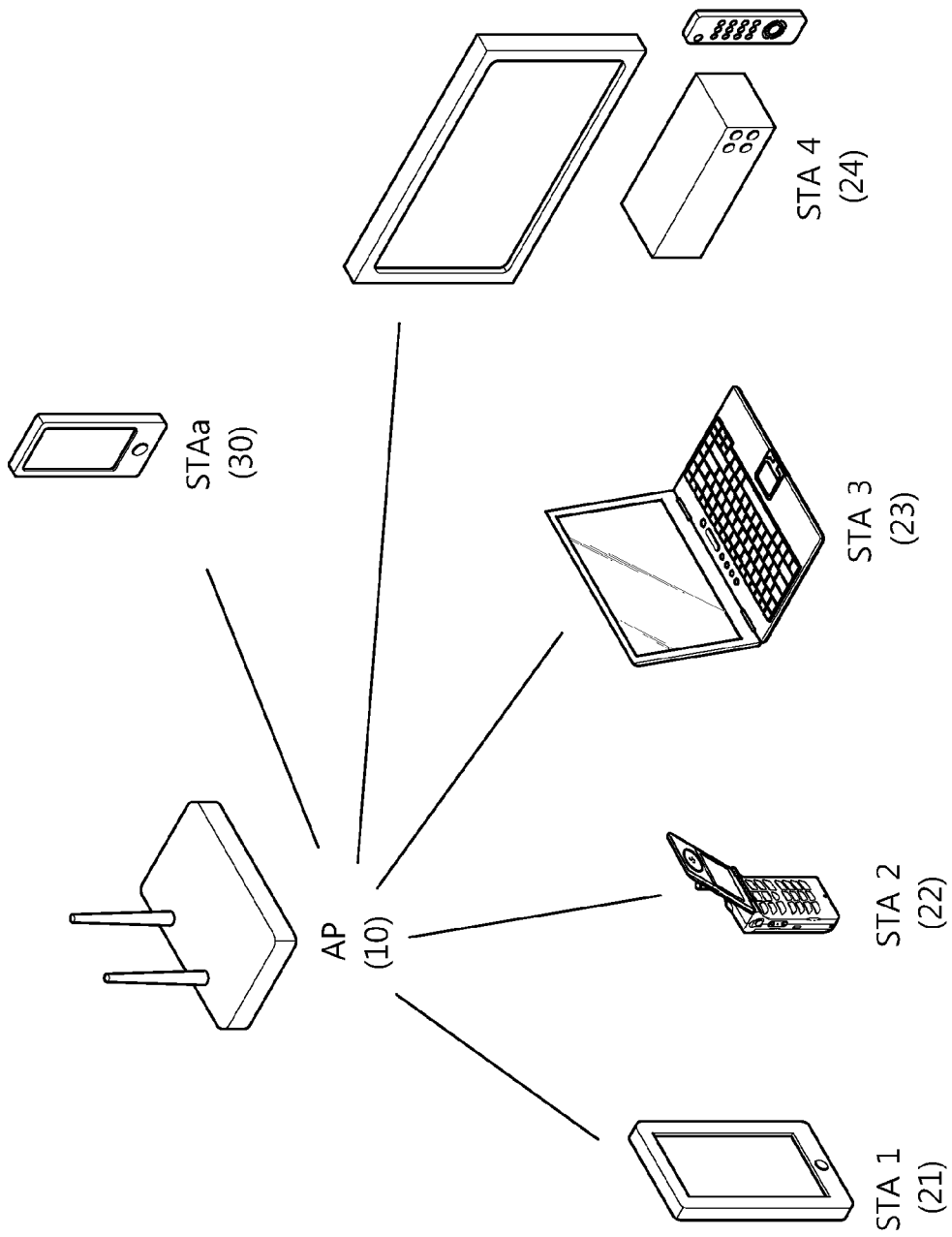

[Fig. 3]

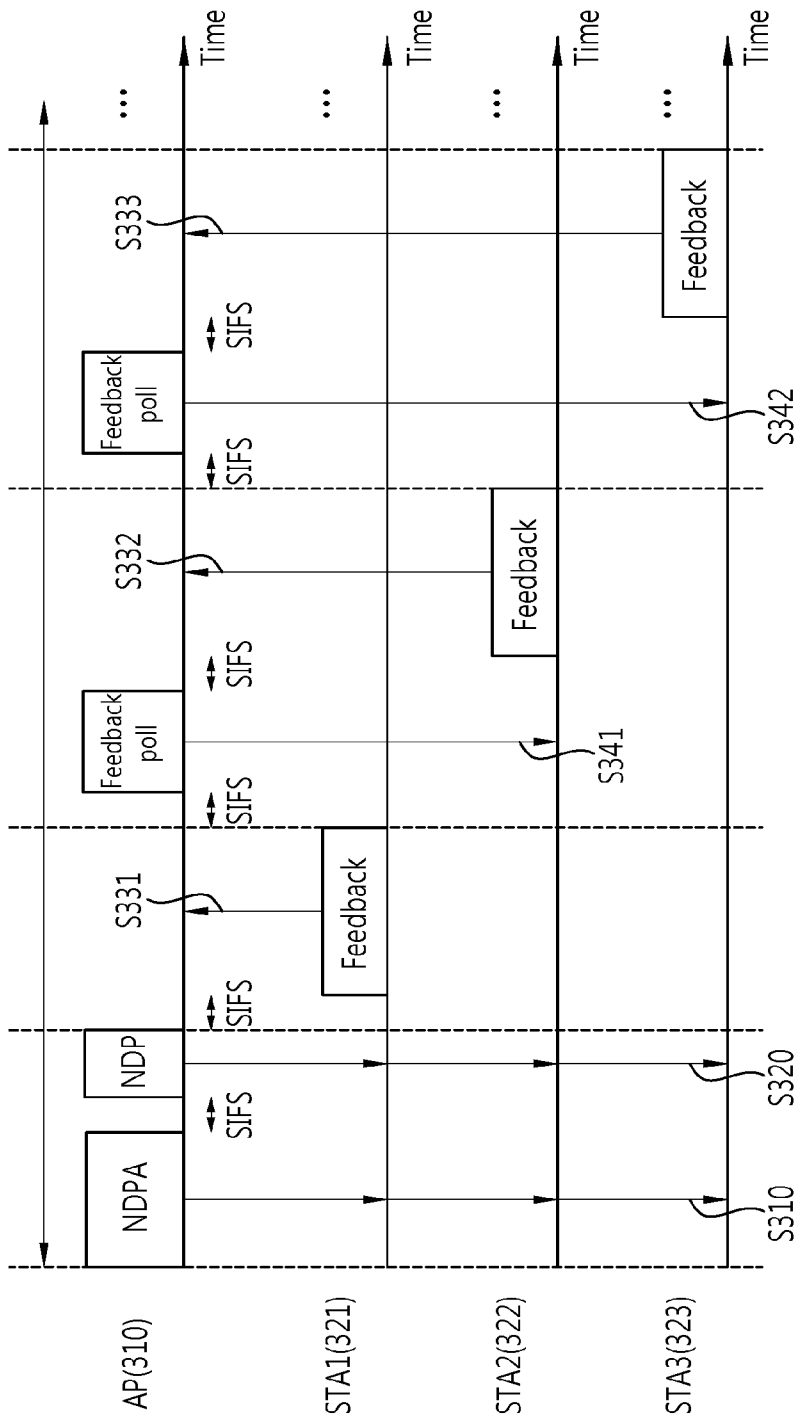

[Fig. 4]

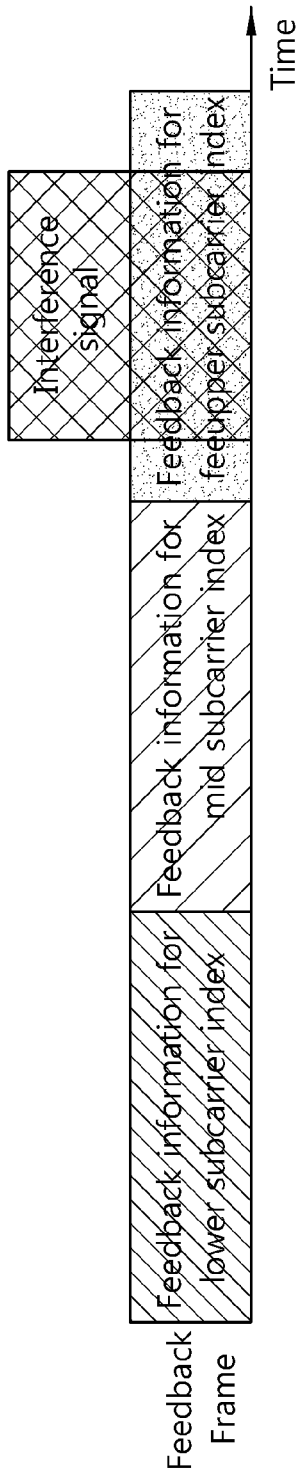

[Fig. 5]

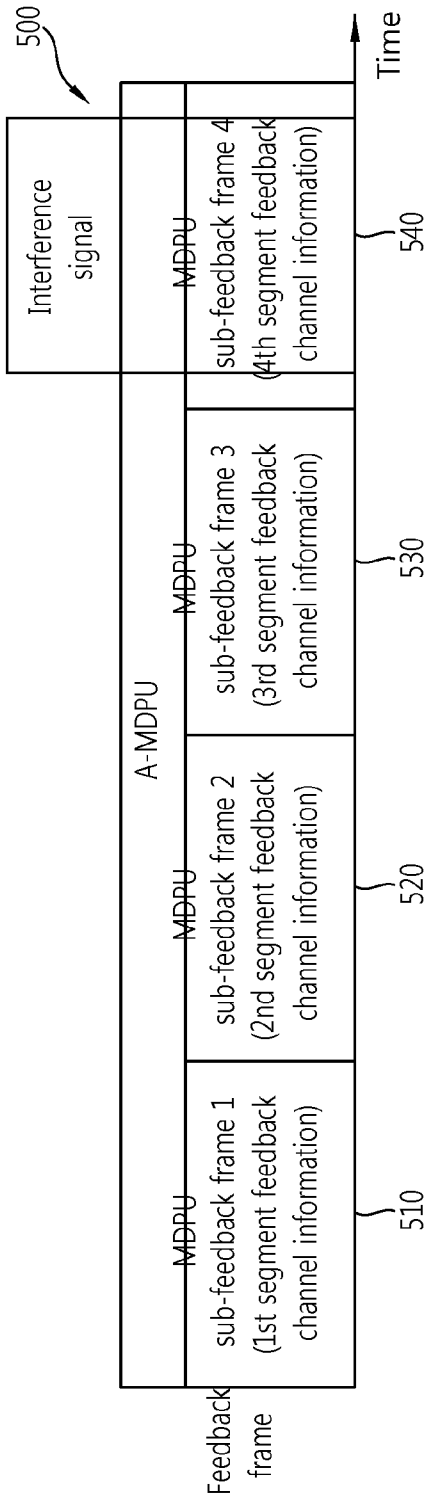

[Fig. 6]

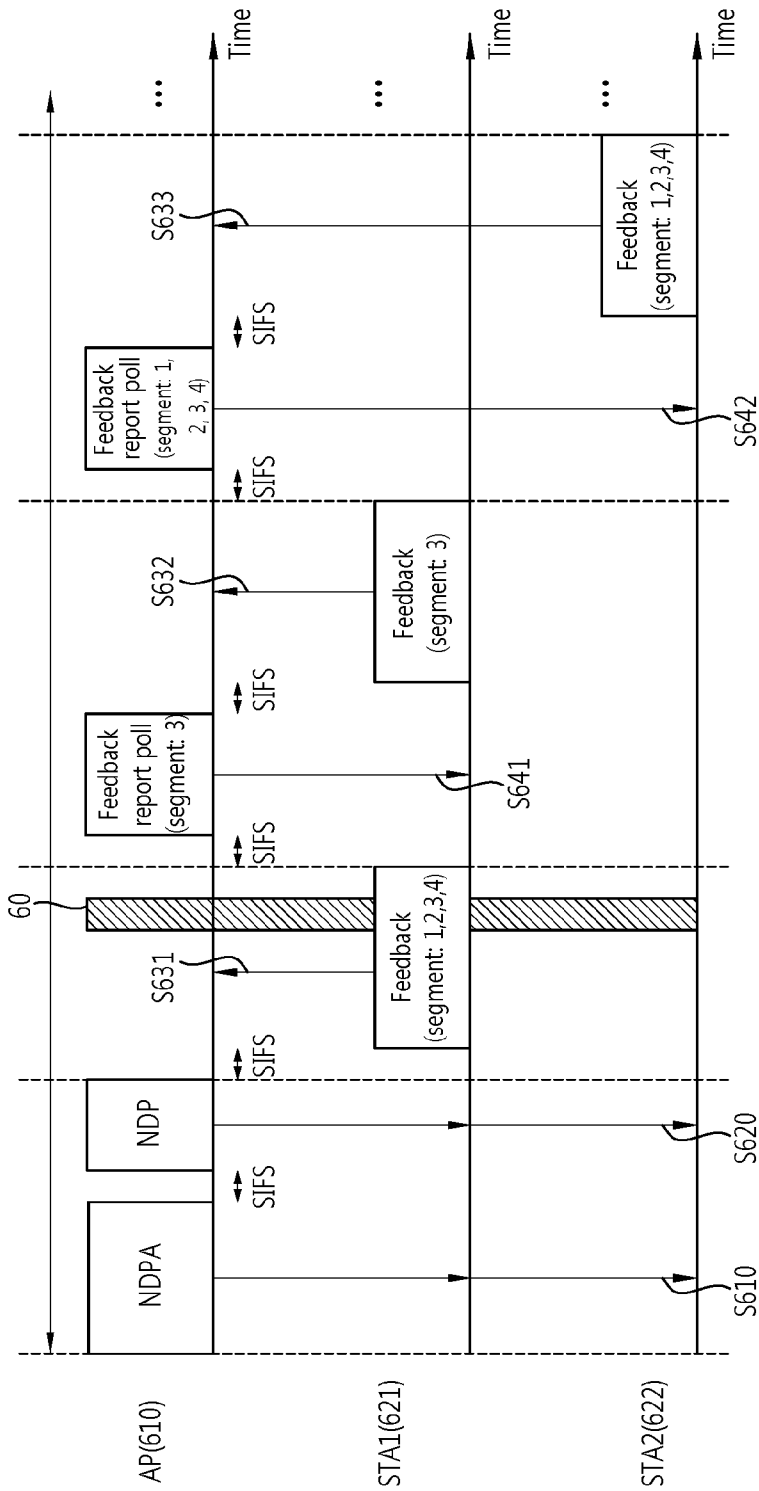

[Fig. 7]

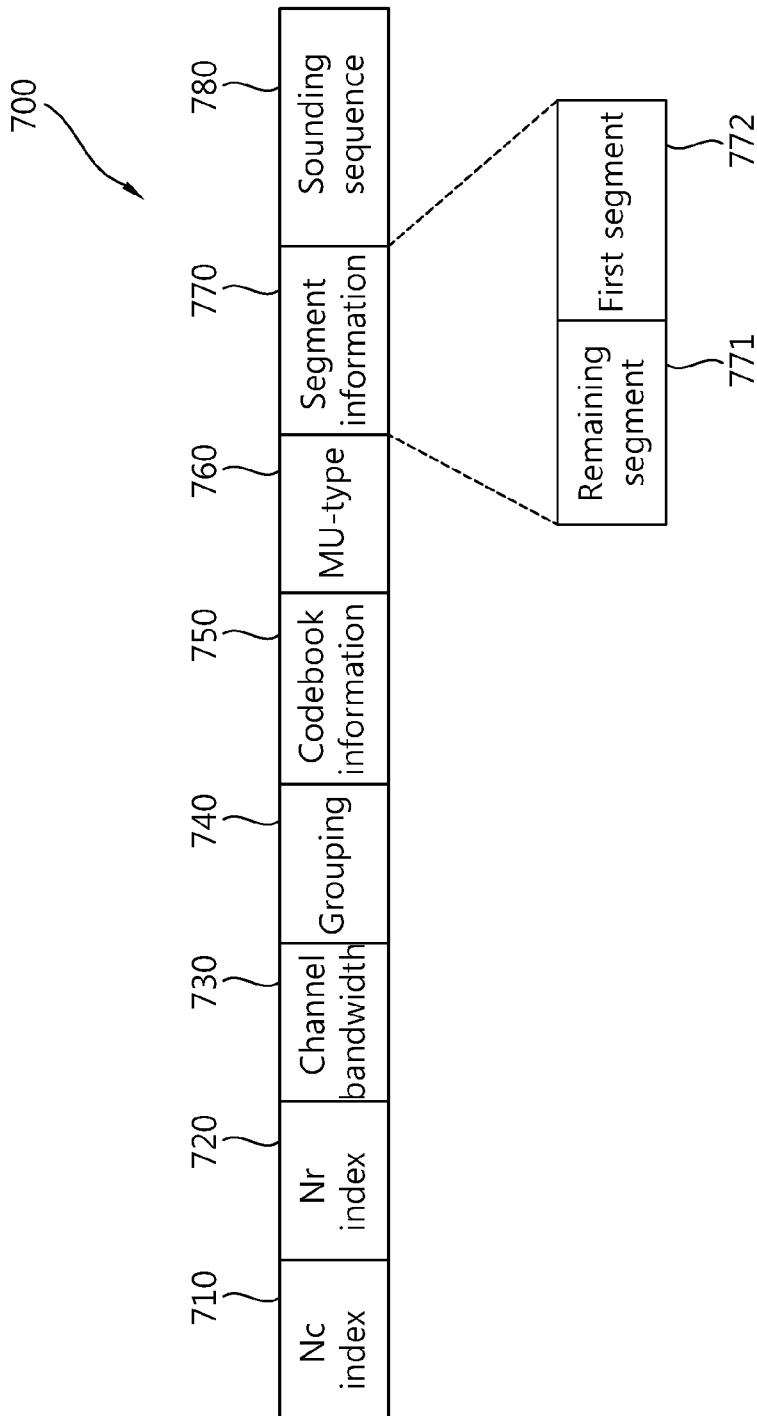

[Fig. 8]

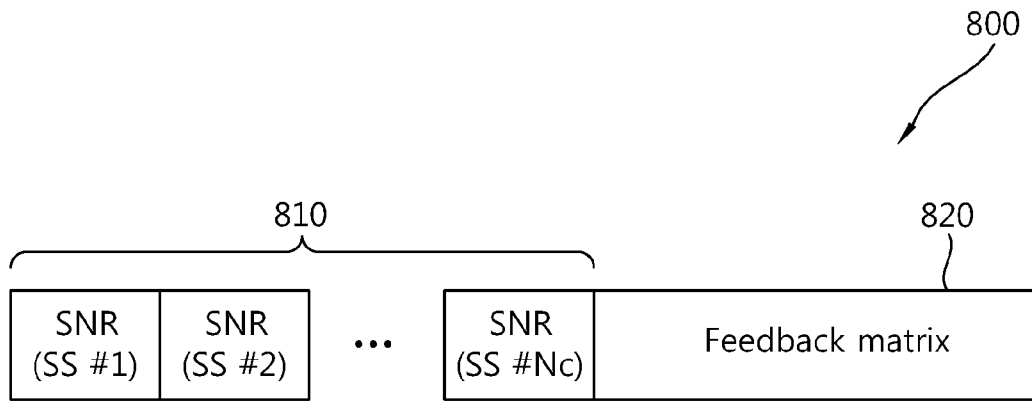

[Fig. 9]

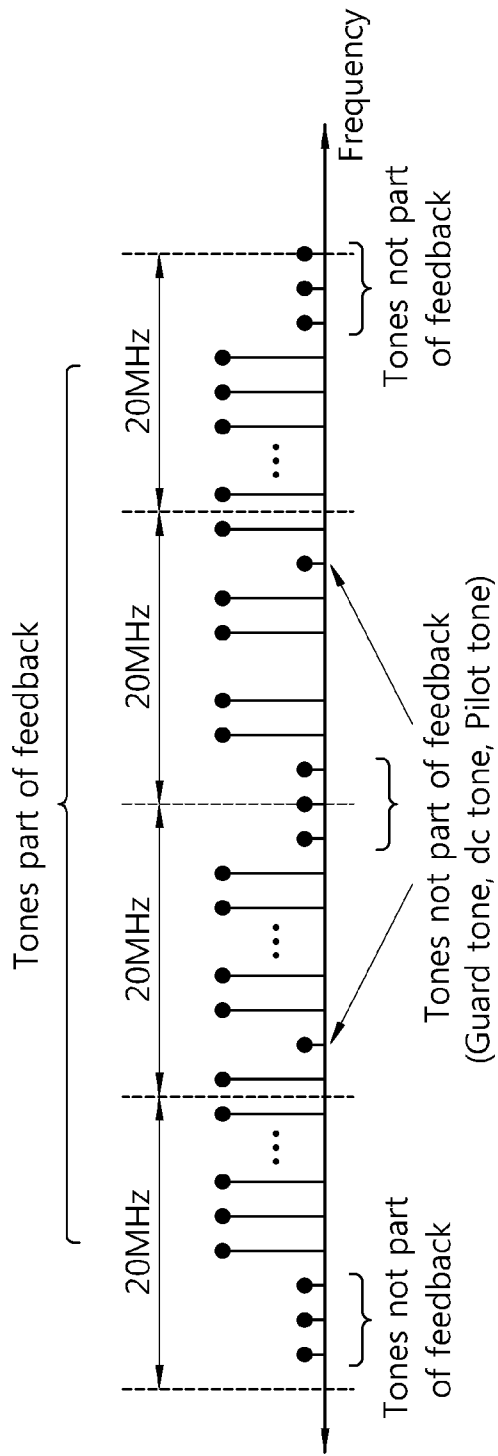

[Fig. 10]

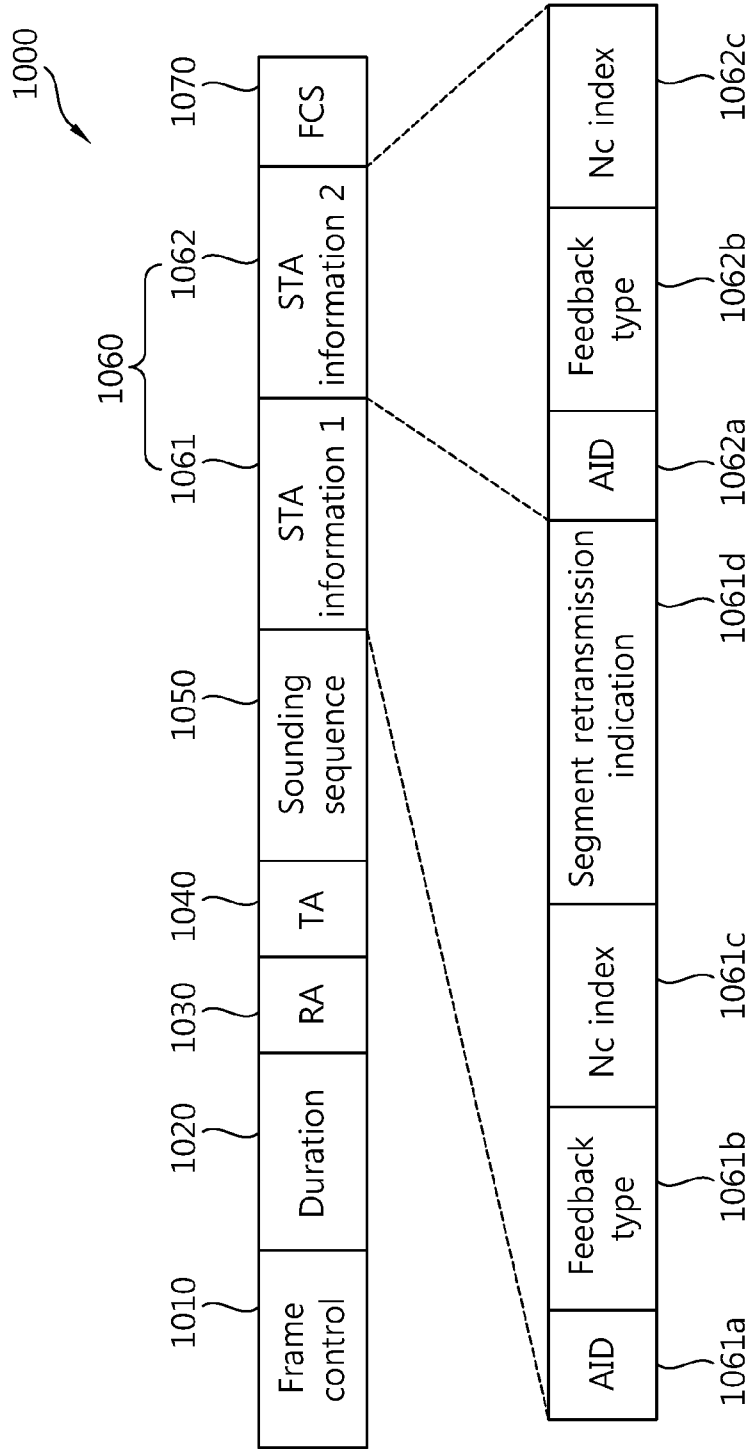

[Fig. 11]

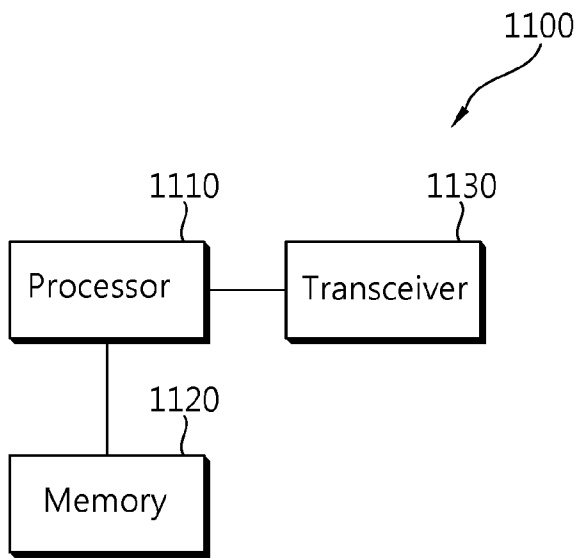

A. CLASSIFICATION OF SUBJECT MATTER**H04B 7/04(2006.01)i, H04W 74/00(2009.01)i**

According to International Patent Classification (IPC) or to both national classification and IPC

B. FIELDS SEARCHED

Minimum documentation searched (classification system followed by classification symbols)

H04B 7/04; H04B 7/00; H04B 1/18; H04L 12/28; H04W 74/00

Documentation searched other than minimum documentation to the extent that such documents are included in the fields searched

Korean utility models and applications for utility models

Japanese utility models and applications for utility models

Electronic data base consulted during the international search (name of data base and, where practicable, search terms used)

eKOMPASS(KIPO internal) & Keywords: WLAN, NDP, announcement, feedback, subfield, segment

C. DOCUMENTS CONSIDERED TO BE RELEVANT

Category*	Citation of document, with indication, where appropriate, of the relevant passages	Relevant to claim No.
A	US 2010-0271992 A1 (WENTINK MAARTEN MENZO et al.) 28 October 2010 See abstract; paragraph [66] - paragraph [71]; figures 2B,2C,3.	1-11
A	WO 2010-068065 A2 (LG ELECTRONICS INC. et al.) 17 June 2010 See abstract; paragraph [46] - paragraph [48]; figure 5.	1-11
A	US 2007-0298742 A1 (JOHN W. KETCHUM et al.) 27 December 2007 See abstract; paragraph [65] - paragraph [67]; figures 4-6.	1-11
A	IEEE802.11-10/1095r0, "Link Adaptation Subfield for VHT", 12 September 2010 See pages 2-4.	1-11

 Further documents are listed in the continuation of Box C. See patent family annex.

* Special categories of cited documents:

"A" document defining the general state of the art which is not considered to be of particular relevance

"E" earlier application or patent but published on or after the international filing date

"L" document which may throw doubts on priority claim(s) or which is cited to establish the publication date of citation or other special reason (as specified)

"O" document referring to an oral disclosure, use, exhibition or other means

"P" document published prior to the international filing date but later than the priority date claimed

"T" later document published after the international filing date or priority date and not in conflict with the application but cited to understand the principle or theory underlying the invention

"X" document of particular relevance; the claimed invention cannot be considered novel or cannot be considered to involve an inventive step when the document is taken alone

"Y" document of particular relevance; the claimed invention cannot be considered to involve an inventive step when the document is combined with one or more other such documents, such combination being obvious to a person skilled in the art

"&" document member of the same patent family

Date of the actual completion of the international search

26 APRIL 2012 (26.04.2012)

Date of mailing of the international search report

27 APRIL 2012 (27.04.2012)

Name and mailing address of the ISA/KR

Korean Intellectual Property Office
Government Complex-Daejeon, 189 Cheongsu-ro,
Seo-gu, Daejeon 302-701, Republic of Korea

Facsimile No. 82-42-472-7140

Authorized officer

KIM, Byoung Sung

Telephone No. 82-42-481-5652



INTERNATIONAL SEARCH REPORT

Information on patent family members

International application No.

PCT/KR2011/009107

Patent document cited in search report	Publication date	Patent family member(s)	Publication date
US 2010-0271992 A1	28.10.2010	KR 10-2012-0003492 A WO 2010-124232 A2 WO 2010-124232 A3	10.01.2012 28.10.2010 05.05.2011
WO 2010-068065 A2	17.06.2010	AU 2009-325247 A1 CA 2746583 A1 EP 2362580 A2 KR 10-2010-0067894 A US 2011-0243025 A1 WO 2010-068065 A3	17.06.2010 17.06.2010 31.08.2011 22.06.2010 06.10.2011 10.09.2010
US 2007-0298742 A1	27.12.2007	CA 2654573 A1 CN 101479958 A EP 2039022 A2 JP 2009-543471 A KR 10-2009-0031434 A RU 2009102533 A WO 2008-002972 A2 WO 2008-002972 A3	03.01.2008 08.07.2009 25.03.2009 03.12.2009 25.03.2009 10.08.2010 03.01.2008 02.05.2008