

(19) **DANMARK**



Patent- og
Varemærkestyrelsen

(10) **DK/EP 3091141 T3**

(12) **Oversættelse af
europæisk patentskrift**

-
- (51) Int.Cl.: ***E 04 F 15/02 (2006.01)*** ***B 32 B 3/06 (2006.01)*** ***B 32 B 3/30 (2006.01)***
B 32 B 21/08 (2006.01) ***E 04 F 15/04 (2006.01)*** ***E 04 F 15/10 (2006.01)***
- (45) Oversættelsen bekendtgjort den: **2018-08-13**
- (80) Dato for Den Europæiske Patentmyndigheds bekendtgørelse om meddelelse af patentet: **2018-06-13**
- (86) Europæisk ansøgning nr.: **16171336.7**
- (86) Europæisk indleveringsdag: **2013-07-01**
- (87) Den europæiske ansøgnings publiceringsdag: **2016-11-09**
- (30) Prioritet: **2012-07-02 US 201261667190 P** **2012-07-02 SE 1250750**
- (62) Stamansøgningsnr: **13813895.3**
- (84) Designerede stater: **AL AT BE BG CH CY CZ DE DK EE ES FI FR GB GR HR HU IE IS IT LI LT LU LV MC MK MT NL NO PL PT RO RS SE SI SK SM TR**
- (73) Patenthaver: **Ceraloc Innovation AB, Prästavägen 513, 263 65 Viken, Sverige**
- (72) Opfinder: **Pervan, Darko, Bygatan 30, 263 61 Viken, Sverige**
- (54) Benævnelse: **GULVPANELER MED REDUCERET VÆGT OG MATERIALEINDHOLD**
- (56) Fremdragne publikationer:
EP-A1- 2 339 092
EP-A2- 2 206 851
DE-B3- 10 300 451
JP-A- H0 347 366
JP-A- H10 299 231
Pervan Darko: "MECHANICAL LOCKING SYSTEM FOR FLOOR PANELS", , 13 September 2011 (2011-09-13), XP055191930, Retrieved from the Internet: URL:- [retrieved on 2015-05-28]

DESCRIPTION

Technical field

[0001] The disclosure generally relates to the field of forming of floor panels, e.g. LVT floor panels. More particular, the disclosure relates to a method of forming floor panels and floor panels produced by the method.

Field of Application of the Invention

[0002] Embodiments of the present invention are particularly suitable for use in floating floors, which are formed of floorboards which are joined mechanically with a locking system and are made up of one or more upper layers of laminated decorative material, an intermediate core of wood-fibre-based material and a lower balancing layer on the rear side of the core. The following description of known technique, problems of known systems and objects and features of the invention will therefore, as a non-restrictive example, be aimed at this field of application and in particular at paper or powder based laminated floorings formed as rectangular floorboards intended to be mechanically joined on both long sides and short sides.

Background of the Invention

[0003] Traditional laminated panels, intended to be used for, e.g. flooring or furniture components, are produced by the following steps as shown in figures 1a - 1d. A decorative paper 2b and a wear resistant transparent overlay paper 2a are impregnated with a thermosetting resin, such as melamine, and are applied on the upper part of a HDF core 3. A balancing paper 4 impregnated with a melamine resin, general called backing, is applied on the backside of a HDF core. The core 3 with the upper 2 and lower 4 layers is moved into a press 5 and pressed under heat and pressure such that the thermosetting resins are cured and the layers are attached to the core as shown in figure 1b.

[0004] Typical press parameters are 40 bar pressure and a temperature of 160-200 C° with a pressing time of 12-30 seconds.

[0005] This production method and product produced by such methods are generally referred to as the DPL process and DPL products (Direct Pressure Laminate) The upper and lower surface layers have generally at thickness of 0,1 - 0,2 mm

[0006] HDF (High density fibreboard) comprises wood fibre and a thermosetting resin that also is cured by heat and pressure to a board with a thickness of about 6 - 12 mm and a density of about 800 kg/m³.

[0007] The most common floor size is a rectangular panel of 1,3 * 0,2 m with a thickness of about 8 mm. The panels are packed and supplied in a packet that contains about 10 panels with a floor area of about 2 m². The weight of each packet is about 16 kg.

[0008] Recently new floor panels with a wood powder based surface and backing have been developed. The paper is replaced with a powder backing 4 comprising wood fibres and melamine particles that is scattered on one side of a core 3 and a powder based surface layer 2 comprising wood fibres, thermosetting resins, preferably melamine particles, aluminium oxide particles and colour pigments, is scattered on the other side of the core that generally is a HDF board. The scattering is made by rollers and brushes and very accurate layers of about 100 - 800 gr/m² may be scattered with high precision on the HDF core material that generally has a thickness of about 7-10 mm. The surface 2, the core 3 and the backing 4 are pressed under heat and pressure in a continuous or discontinuous press 5 to obtain a product with a paper free and solid surface layer and backing.

[0009] The pressed powder based layers may have a thickness of about 0,2 - 1,0 mm. Typical press parameters are similar to conventional laminate flooring and may be a pressure of 40 - 80 bar and a temperature of 160-200 C° with a pressing time of 10 - 40 seconds.

[0010] Such wood fibre based floors, generally referred to as WFF floors, have considerably better properties than traditional laminate floors since a thicker and more impact and wear resistant surface may be produced in a cost efficient way.

[0011] These two production methods may be combined.

[0012] A laminate floor with a paper based surface layer may have a powder based sub layer under the decorative paper in order to provide better impact resistance and deeper embossing. The paper backing may be replaced with a powder backing. The sub layer may be used to impregnate the decorative paper during pressing when the resins from the sub layer penetrate into the decorative paper.

[0013] WFF floor may also have several different layers on the upper side for example a high quality top layer 2a and a more cost efficient sub layer 2b under the top layer. The sub layer may comprise lower resin content and no aluminium oxide particles are needed.

[0014] A common feature for the paper or powder based surface layers, the paper or powder based backing layers and the HDF core is that all these materials comprise wood fibres and thermosetting binders, preferably melamine or urea, and that they are cured by heat and pressure. The wood fibres may be of the same type.

[0015] The layers are exposed to a first shrinking when the thermosetting resin in the upper and lower layer cures during pressing. The HDF core is also heated and becomes soft and easy to bend. The backing layer balances the tension that is created by the surface layer and

the panel is substantially flat with a small convex backward bending when it leaves the press. The second temperature shrinking, when the panels is cooled from about 160-200°C to room temperature, is also balanced by the backing layer and the panel 1 is essentially flat. A small convex backward bending is preferred since this counteracts upward bending of the edges in dry conditions when the relative humidity may go down to 20% or lower during wintertime.

[0016] This essentially flat pressed board comprises tension forces caused by the shrinking of the surface and balancing layers.

[0017] The board is generally cut and formed into several floor panels with locking systems on long and short edges as shown in figure 1c. The locking system comprises generally a tongue 10 and a tongue groove 9 for vertical locking and a strip 6 with a locking element 8 that cooperates with a locking groove 14 for horizontal locking.

[0018] The surface layer 2 has about the same length and width as the backing layer 4 as shown in figure 1d. The locking system may be formed in one piece with the core. Alternatively separate materials may be used to form for example the tongue 10 and/or the strip 6.

[0019] The prices for wood fibres and thermosetting resins are increasing and major increases are expected in the future due to shortage and the possibility to use wood fibres for energy production.

[0020] Several methods have been used to save material and to reduce costs. Such methods are mainly aiming to make thinner products that comprise a minimum of resins. Further cost savings are limited by minimum quality requirements related to the floor panel and the geometry of locking system.

[0021] The invention relates only to floor panels having an intermediate core, a surface layer and a backing layer all comprise thermoplastic material. Such floor panels are disclosed in EP2339092 A1, which represents the closest prior art. It would be a major advantage if it would be possible to reduce the weight and material content. The problem with the present laminate and WFF floors is that they must have a high density core such as HDF that is needed for the stability, impact resistance and the strength which is needed to resist the heat and pressure from the pressing operation. Another problem is that the panels must have a minimum thickness and a core with high shear strength in order to allow the forming of a locking system with sufficient strength and geometry that allows easy installation.

[0022] It is known that grooves may be formed on the rear side of solid wood floors mainly in order to increase the flexibility of the panel. Such panels are easier to glue down to the sub floor. Grooves at the rear side of the panels are not used in laminate and WFF floors, which are installed with mechanical locking systems. The main reason is that such groove will have a negative impact on the stability of the panel and on the locking system since material will be removed from the balancing layer and the lower parts of the locking system.

Definition of some terms

[0023] In the following text, the visible surface of the installed floorboard is called "*front side*" or "*surface*", while the opposite side of the floorboard, facing the subfloor, is called "*rear side*". The starting board material that is used as a base material is called "*core*". When the core is coated with a surface layer closest to the front side and preferably also a balancing layer closest to the rear side, it forms a semi manufacture, which is called "*a board*" that in a subsequent operation generally is divided and machined into a plurality of "*floor panels*".

[0024] By "*horizontal plane*" is meant a plane, which extends parallel to the outer part of the surface layer. Immediately juxtaposed upper parts of two neighbouring joint edges of two joined floorboards together define a "*vertical plane*" perpendicular to the horizontal plane.

[0025] The outer parts of the floorboard at the edge of the floorboard between the front side and the rear side are called "*joint edge*". As a rule, the joint edge has several "*joint surfaces*" which may be vertical, horizontal, angled, rounded, beveled etc.

[0026] By "*locking system*" is meant co-acting connecting means, which connect the floor panel vertically and/or horizontally. By "*mechanical locking system*" is meant that joining may take place without glue.

[0027] By "*up or upward*" means toward the surface and by "*down or downward*" means toward the rear side. By "*inwardly*" is meant towards the centre of the floorboard and by "*outwardly*" means in the opposite direction.

[0028] By "*carving*" is meant a method to form a groove or a protrusion on an edge of a panel by carving a part of the edge to its final shape by one or several carving tool configurations comprising several non-rotating and fixed chipremoving surfaces located along the feeding direction

Summary of the invention

[0029] An objective of embodiments of the present invention is to provide laminated floor panels comprising a thermoplastic material with the aim to reduce the weight and material content of such floor panels, and to combine such cost saving and material reducing methods with a high quality locking systems and a core that provides sufficient stability which is needed in the pressing operation and when the floor is used. A further objective of a presently non-claimed aspect of the invention is to provide solid wood floors with reduced weight and material content and increased stability.

[0030] A first aspect of the invention is floor panels having a surface layer on the front side, an

intermediate core and a backing layer on the rear side of the core, wherein the core and the layers all comprise a thermoplastic material. The panels are provided with a locking system for vertical and horizontal locking of a first edge of a first floor panel to an adjacent second edge of a second floor panel. The upper parts of the first and the second edge in a locked position together define a vertical plane perpendicular to a horizontal plane, which is parallel to the surface. Said locking system comprises a tongue and a tongue groove configured to cooperate for vertical locking, and a strip, which is provided with a locking element and configured to cooperate for horizontal locking with a downwardly open locking groove formed in an adjacent edge. The backing layer and the core comprise several vertically extending core grooves with an opening towards the rear side. The area of the backing layer is less than about 90% of the area of the surface layer.

[0031] The backing layer may comprise at least three core grooves spaced horizontally and inwardly from the locking system at one pair of opposite edges.

[0032] The area of the backing layer may be less than 80% of the area of the surface layer.

[0033] The entire parts of at least one core groove may be located inside the vertical plane VP at all edges.

[0034] The panels may be rectangular with long edges and short edges and the core grooves may be parallel with the long edges.

[0035] The core grooves may have a groove depth that is at least 0,3 times the floor thickness.

[0036] The core grooves may comprise an opening that is large than an inner part of the grooves.

[0037] The backing layer may comprise essentially the same fibres as the core.

[0038] A second aspect of the invention, not presently claimed, is a method to produce floor panels each having a surface layer on the front side, an intermediate core and a backing layer on the rear side of the core wherein the core and the layers all comprise wood fibres and thermosetting resins. The method comprises the steps of:

- creating wood fibre chips by forming core grooves in the rear side of previously produced panel;
- producing a mix by mixing the wood chips with thermosetting resin,
- scattering the mix of wood chips and thermosetting resin on the upper and/or lower side of the core,
- forming a board by curing the mix with heat and pressure,
- cutting the board into several floor panels, and
- forming a locking system at a first and a second panel edge, the locking system

comprises a strip, a locking element and a locking groove for horizontal locking and a tongue and a tongue groove for vertical locking.

[0039] The mix may be scattered on the lower side of the core.

[0040] The mix may be scattered on the upper and lower side of the core.

[0041] The core may be HDF.

[0042] The core grooves may be formed prior to the forming of the locking system on long or short edges.

[0043] The core grooves may be formed by a jumping tool comprising several rotating saw blades or a carving tool.

[0044] The pressed board may be more convex than the floor panel.

[0045] The core grooves are used to create wood fibre material that may be used in a second step to form the upper or lower layers of the floor panel. The material that is removed from the core when forming the core grooves, reduces the weight of the panel in spite of the fact that the original panel thickness is maintained and that a panel which is thicker than the original core may be formed by using the chips from the forming of the core grooves. The whole floor panel including the upper and lower layers may be formed by materials comprising the material from the core.

[0046] The core and the layers may, as an alternative, comprise a thermoplastic material, such as PVC, PET or vinyl, preferably provided with a filler, and the chips created are, for this alternative embodiment, plastic chips.

[0047] The locking system may, as an alternative, comprise a protruding strip at the first or the second panel edge and a recess on a lower side of the other of said first or second panel edge. An upper surface of the protruding strip or a lower surface of the recess is preferably provided with an adhesive, such as an adhesive tape, preferably provided with a removable strip.

[0048] A third aspect of the invention, not presently claimed, is a wood based floor panel having an upper and a lower layer of solid wood. The lower layer comprises cavities and that the upper layer form an upper part of the cavities.

[0049] The panels may have a mechanical locking system at two opposite edges.

[0050] A fourth aspect of the invention, not presently claimed, is a method to produce

essentially flat floor panels, each having a surface layer on a front side, a backing layer on a rear side, and an intermediate core, wherein the surface and backing layer comprise thermosetting resins and wherein the method comprises the steps of:

- forming a large board with convex pretension backwards by attaching the core, the surface layer and the backing layer with heat and pressure;
- dividing the board into several floor panels;
- forming core grooves at the rear side of the panels such that the convex pretension is at least partly released.

[0051] The core grooves may be formed after the dividing of the board into several floor panels.

[0052] The above objects are achieved wholly or partly by locking systems, floor panels and production methods according to embodiments of the invention.

Brief Description of the Drawings

[0053] The present invention will by way of example be described in more detail with reference to the appended schematic drawings, which shows embodiments of the present invention.

Figs 1a-d

illustrate known technology.

Figs 2a-d

illustrate a floor panel according an embodiment to the invention.

Figs 3a-e

illustrate alternative embodiments of the invention.

Figs 4a-d

illustrate forming of a floor panel according to an embodiment of the invention.

Figs 5a-e

illustrate embodiments of core grooves.

Figs 6a-e

illustrate balancing of a panel with core grooves and core grooves in a solid wood floor according to embodiments of the invention.

Figs 7a-c

illustrate embodiments of tools to form core grooves.

Figs 8a-c

illustrate embodiments of cost efficient locking systems that may be combined with core grooves.

Description of Embodiments of the Invention

[0054] A first embodiment of floorboards provided with a mechanical locking system according to the invention is shown in figures 2a - 2d. The floor panel comprises a locking system on long 1a, 1b and short 1c, 1d edges. Figure 2a shows the front side with the surface layer 2 and figure 2b shows the rear side with the backing layer 4. The area of the surface layer A' is essentially the same as the area A of the backing layer 4. Figure 2c shows that essentially vertical core grooves 19a, 19b, with an opening toward the rear side of the panel, may be formed on the rear side in the backing layer 4 and into the core 3 that may be a wood based board such as for example HDF, chipboard or plywood. The core may also comprise plastic material. Such forming may be made with rotating saw blades 20a as shown in figure 2d. Carving may also be used. The panels are generally machined with the surface layer 2 pointing downwards. The jumping saw blade is displaced towards the panel 20a from above, or below if the surface layer 2 is pointing upwards, and away from the panel 20c when the panel moves relative the rotating saw blades. Several core grooves 19a, 19b are formed that in this preferred embodiment are located inwardly from the edges and preferably also inwardly from the vertical plane VP such that they do not intersect any part of the locking systems on the long and short edges. The grooves 19 may also be formed with fixed or jumping non-rotation carving tools.

[0055] The forming of the grooves creates wood chips 21 that according to embodiments of the invention may be milled and sieved to wood powder that may be mixed with thermosetting resin and scattered on a core to form the surface and/or backing layer. The core grooves are mainly used to provide wood fibre material that may be used in the upper 2 or lower 4 layers in order to save material. They may also be used to decrease the weight of the floor panel.

[0056] Figure 3a-3e show that the core grooves 19 may be formed with many different geometries and patterns. The core grooves 19 may have different widths as shown in figure 3b and the groove length may be smaller than the length BL of the backing layer. They may be discontinuous as shown in figure 3c and 3d and they may extend from one edge to the other edge as shown in figure 3e. The grooves may also be located mainly at the outer parts of the backing layer and there may be a middle area MA without any grooves. This may be used to increase the stability of the panel and to reduce the negative impact on the backing layer when parts of the backing layer are removed. The grooves may be formed along the long sides and/or along the short sides. The panels may also be square.

[0057] The core grooves reduces the area A of the backing layer. The area A of the backing layer is in the shown embodiments about 60 % - 85 % of the area A' of the surface layer. This means that the balancing layer will lose 40 -15% of its strength. A thicker backing layer or increased resin content may compensate such reduced backing area.

[0058] It is possible to form core grooves that reduce the backing area A with more than 50%

compared to the initial area after pressing and the area A' of the surface layer.

[0059] Figure 4a- 4d show forming of a floor panel 1 according to embodiments of the invention. A wood powder based sub layer 2b is applied on a core 3. Figure 4b shows that a surface layer 2 comprising a top layer 2a of wood powder or a decorative paper and overlay may be applied on the sub layer 2b. A powder backing layer 4 may be applied on the rear side of the core 3. Figure 4c shows the forming of a core groove 19 that creates chips 21. Such chips may be milled, sieved and mixed with thermosetting binders. This material may be scattered on the core to form the wood based top layer and/or sublayer and/or backing layer as shown in figure 4b. Finally the locking system 10, 9, 6, 8, 14 is formed as shown in figure 4d.

[0060] The milling or carving of the core grooves may be formed after pressing and prior to the sawing the large board into individual panels, after sawing but prior to the forming of the locking system, after the forming of the locking system on two opposite edges for example the long edges or as a final operation after the forming of the locking system. Such production steps may be combined and some grooves made be formed in several production steps.

[0061] The core grooves may easily provide sufficient wood fibre material for the various layers described above. The cured thermosetting resins from the chips are compatible with the melamine powder that is mixed into the wood powder and no separation of fibres and cured resins is needed. The backing and the surface may comprise new virgin thermosetting resins and already cured resins.

[0062] Figures 5a - e show different preferred geometries of the core grooves that may comprise a vertically extending groove depth GD of for example 0,1 - 0,5 times the floor thickness T, a groove width GW of about 0,5 - 1 times the floor thickness T and there may be a horizontally extending space S between the core grooves of about 0, 2 - 1 times the floor thickness T as shown in figure 5a.

[0063] The core grooves may have different shapes and the inner core grooves 19b may be formed with a smaller groove depth GD than the outer grooves 19a in order to increase the stability of the panel. Core grooves 19c may also be formed with an undercut by for example a carving tool 20.

[0064] Core grooves with a groove depth GD of for example 0,8 times the panel thickness T may be formed in wall panels where the requirements on the impact resistance are much lower than in for floor panels.

[0065] Figures 5c - 5e show the core grooves 19 seen from the long edges. The panels have a fold down locking system on the short edges 1c, 1d with a flexible tongue 10 that allows locking with vertical folding. Figure 5c shows a core groove 19 with a groove length GL which is smaller than the distance between the locking systems at opposite short edges. Figure 5d shows that the core groove 10 is curved at one short edge 1d and parallel with the surface at

the other edge 1c such that it intersects a part of the locking groove 14. Such embodiments allows that the jumping tool have to be displaced during forming only when the forming of the core grooves 19 starts or ends. Figure 5e shows a core groove 19 that is formed with a fixed tool and that intersects the locking strip 6 and the locking groove 14.

[0066] The core grooves may provide sufficient material to for example produce a 0,5 mm backing layer and a 0,5 mm sub layer. A 7 mm HDF core may be used to produce an 8 mm floor panel by using the material from the core to form the backing layer and preferably at least parts of the surface layers. This may result in a material saving and weight reduction of about 15 %.

[0067] An even larger material saving and weight reduction of about 20% may be reached if core grooves are formed such that they reduce the backing layer with 50% of the floor surface and with a groove depth GD of 40% of the floor thickness T.

[0068] The core grooves may be filled with material that preferably is cheaper than wood and/or that gives the floor other properties such as for example an increased sound reduction.

[0069] The chips may of course also be used completely or partly to create thermal energy. Embodiments of the invention may therefore also be used in floors that comprises a wood based core and where the core grooves are used for weight reduction and the chips for energy or as filler in various applications.

[0070] Forming of core grooves after pressing provides the advantage that the backing layer counteracts the shrinking of the top layer during pressing and cooling and the pressed board is at this production stage not effected by the core grooves that are formed in the floor panel after the pressing operation.

[0071] However, the forming of the core grooves removes a part of the balancing layer and this may result in that tension is released and that the panel edges bend upward after the forming of the grooves. Such a panel will not be completely flat and may be slightly concave along the length and the width.

[0072] Figures 6a - 6c show that such problems may be counteracted and completely eliminated if the large board is formed with a pre tension backwards that is adapted to the dimensional changes caused by the forming of the core grooves as shown in figure 6a. The pretension may be accomplished for example by a thicker backing layer that may comprise more resins and that may be cured at a higher temperature than the surface layer. Such a production method is characterized in that the board, when pressed and cooled, has a larger backwards bending than the final floor panel with core grooves on the rear side. Even a mechanical bending directly after the pressing when the board is still hot may be used to accomplish a plastic deformation and to stretch the surface layer such that an "over bending" backwards may be created that partly springs back to an essentially flat position when the core grooves 19 are formed. Figure 6b shows that part of the tension is released when the core

grooves are formed and the floor panel may be essentially flat when the grooves and the edges are formed as shown in figure 6c.

[0073] Figure 6c shows that the core grooves may be covered with a separate covering layer 23 for example a paper, a plastic foil, foam, cork or a wood veneer. This may be used to hide the grooves, to provide a moisture sealing or to reduce sound. The core grooves according to embodiments of the invention may therefore also be used in veneered floors where an upper and lower wood veneer is glued to a wood based core such as plywood, HDF or a chipboard.

[0074] Figure 6d shows that the method to form core grooves 19 may also be used in solid wood floors where core grooves 19 are formed in the solid wood body 3, preferably along the fibres 24 in the length direction of the panel. A wood veneer or a wood sheet may be used as a covering layer 23 to cover the opening 25 of the core grooves 19. Such wood based covering layer 23, that may have a thickness of for example 0,5 -1,0 mm or more, may also provide stability and may counteract bending and warping. The moisture content of the veneer may be adapted to the moisture content of the solid wood body such that a tension is obtained when the veneer or the wood sheet shrinks.

[0075] Figure 6e shows a wood based floor panel having an upper 2 and a lower 4 layer of solid wood. The layer may be made of different wood types that are glued to each other. The lower layer 4 comprises cavities 26. The upper layer may form an upper part 27 of such cavities. The cavities may also be formed in the upper layer and the lower layer may form a lower part of such cavities.

[0076] The different wood types that are glued to each other may have about the same thickness. The locking system may be formed partly or completely in the lower layer 4. Core grooves 19 with an opening that points downwards may also be formed in the lower layer 4. The embodiment shown in fig 6e may comprise HDF boards, instead of the solid wood layers, that may be formed and glued together in the same manner as described above. Such a combination core may be laminated as a conventional solid HDF board. This method is particularly suitable to be used for thicker laminated panels of a thickness of about 8-12 mm.

[0077] Core grooves or cavities formed in solid wood provide the advantages that the weight of the solid wood floor may be reduced and increased stability may be obtained.

[0078] The chips from the core grooves or cavities may be used for thermal energy or to produce wood fibres for other powder based floors or fibre based boards such as particleboards. It is also possible to mix the wood chips with a binder and to produce an artificial wood veneer that may be handled as a separate layer and glued against the opening of the core grooves.

[0079] The same technology may be used in a floor with a plywood based core and a veneered surface layer.

[0080] Figure 7a shows a tool 20 comprising several rotating saw blades that may be used to form core grooves 19.

[0081] Figure 7b shows a carving tool 20 with several carving teeth 20a-d that are offset horizontally. The carving tool is preferably fixed in the horizontal direction and the panel is displaced against the carving tool in the feeding direction FD against the tool. Each tooth may carve about 0,3 -0,5 mm in HDF material. The groove may be V or U shaped or even undercut with an inner part that has a larger horizontal extension perpendicular to the groove length than the opening.

[0082] Figures 8a -8c show that further cost savings may be reached with locking systems that are adapted to be separated from the large board with overlapping edges OL and with a non liner cut that preferably is made with carving tools 20a, 20b. Figure 8a shows a locking system, which comprises a protruding tongue 10 and a protruding strip 6 on the same edge. Such joint geometry may be used to accomplish a considerable reduction of the material waste W that is caused when the panels are cut and when the locking systems are formed. Figure 8c shows that the rear side 6a of the strip 6 may be formed such that the rear side of the strip is inclined upwards and such that an outer part of the strip is closer to the surface than an inner part. All such forming and material waste may be used to provide wood fibres that may be used in in upper or lower layers of a panel.

[0083] Core grooves may be combined with non-linear separation and locking systems that make it possible to divide the board into several panels that have geometry such that they may be positioned in the same horizontal plane HP with overlapping edges.

[0084] It is possible to form the whole floor panel from the wood material obtained from the core of other floor panels. Only melamine powder has to be added into the mix. The upper layer may be harder than the core since a higher density may be created during the pressing of the powder mix. Such panels may be formed with embossed structures and may be painted, lacquered or digitally printed in the factory or panted and/or lacquered after installation.

REFERENCES CITED IN THE DESCRIPTION

This list of references cited by the applicant is for the reader's convenience only. It does not form part of the European patent document. Even though great care has been taken in compiling the references, errors or omissions cannot be excluded and the EPO disclaims all liability in this regard.

Patent documents cited in the description

- EP2339092A1 [0021]

PATENTKRAV

1. Gulvpaneler (1, 1'), der hvert har et overfladelag (2) på en forside, et bagsidelag (4) på en bagside og en midterkerne (3), hvor midterkernen og
5 overfladelaget og bagsidelaget alle omfatter et termoplastisk materiale, hvilke gulvpaneler er forsynet med et låsesystem til lodret og vandret låsning af en første kant af et første gulvpanel (1) til en hosliggende anden kant af et andet gulvpanel (1'), hvor øvre dele af den første kant og den anden kant i en låst position
10 tilsammen definerer et lodret plan (VP), der står vinkelret på et vandret plan (HP), som er parallelt med overfladelaget (2), hvilket låsesystem omfatter en tunge (10) og en tungerille (9), der er konfigureret til at samvirke til lodret låsning, og ved den første kant et bånd (6) udstyret med et låseelement (8), der er konfigureret til at samvirke til vandret låsning med en nedad åben låserille (14) udformet i den anden kant, **kendetegnet ved**, at bagsidelaget (4) og midterkernen (3) omfatter
15 mindst to lodret forløbende kerneriller (19) med en åbning mod bagsiden, og at bagsidelagets areal (A) er mindre end ca. 90% af overfladelagets areal (A').
2. Gulvpaneler ifølge krav 1, hvor bagsidelaget (4) omfatter mindst tre kerneriller (19), der er adskilt vandret og indad fra låsesystemet ved et par
20 modstående kanter.
3. Gulvpaneler ifølge krav 1 eller 2, hvor bagsidelagets (4) areal (A) er mindre end 80% af overfladelagets areal (A').
- 25 4. Gulvpaneler ifølge ethvert af kravene 1-3, hvor alle delene af mindst én kernerille (19) er anbragt inde i det lodrette plan (VP) ved alle kanter.
5. Gulvpaneler ifølge ethvert af de foregående krav, hvor gulvpanelerne er rektangulære med lange kanter (1a, 1b) og korte kanter (1c, 1d), og hvor
30 kernerillerne (19) er i det væsentlige parallelle med de lange kanter.
6. Gulvpaneler ifølge ethvert af de foregående krav, hvor kernerilledybden (GD) er mindst 0,3 gange en gulvtykkelse (T).

7. Gulvpaneler ifølge ethvert af de foregående krav, hvor kernerillerne (19) omfatter en åbning med en rillebredde (GW), der er større end en inderdel af rillen.
8. Gulvpaneler ifølge ethvert af de foregående krav, hvor det termoplastiske
5 materiale er PVC, PET eller vinyl.
9. Gulvpaneler ifølge ethvert af de foregående krav, hvor midterkernen, overfladelaget og bagsidelaget omfatter et fyldmateriale.
- 10 10. Gulvpaneler ifølge ethvert af de foregående krav, hvor gulvpanelerne har et sammenfoldningslåsesystem på de korte kanter (1c, 1d) med en bøjelig tunge (10), der tillader låsning med lodret foldning.
11. Gulvpaneler ifølge ethvert af de foregående krav, hvor kernerillerne (19)
15 har en rillelængde (GL), der er mindre end en afstand mellem låsesystemerne ved modstående, korte kanter.
12. Gulvpaneler ifølge ethvert af de foregående krav, hvor kernerillerne (19)
20 krydser banen (6) og låserillen (14).
13. Gulvpaneler ifølge ethvert af de foregående krav, hvor kernerillerne (19) strækker sig fra den ene kant til den anden kant af gulvpanelerne.
14. Gulvpaneler ifølge ethvert af de foregående krav, hvor en rillelængde er
25 mindre end en længde (BL) af bagsidelaget.
15. Gulvpaneler ifølge ethvert af de foregående krav, hvor kernerillerne (19) er diskontinuerlige.
-

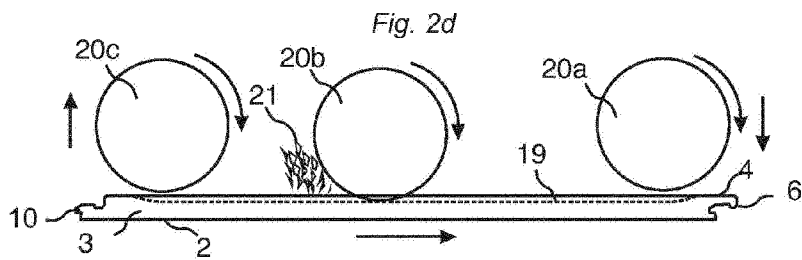
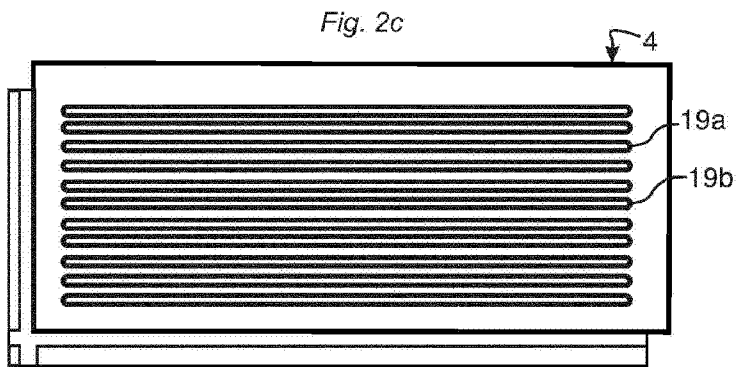
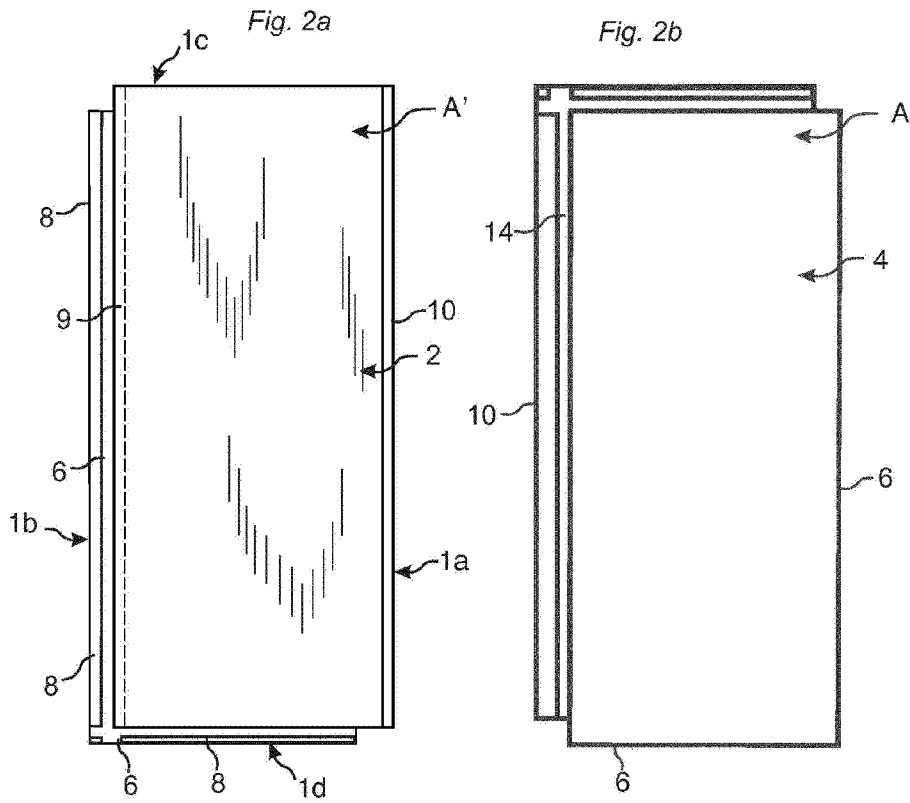

Fig. 3a

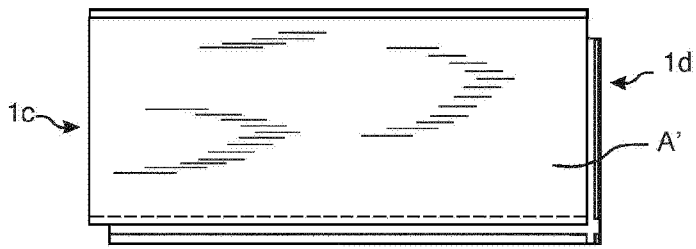

Fig. 3b

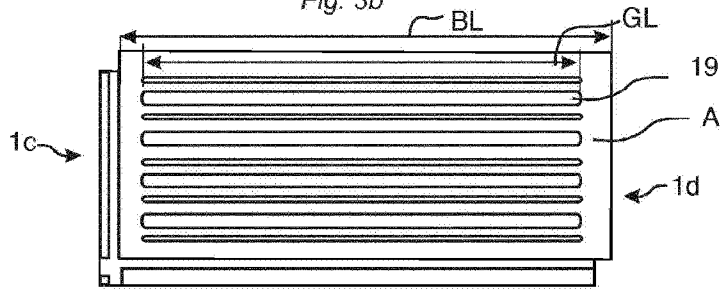

Fig. 3c

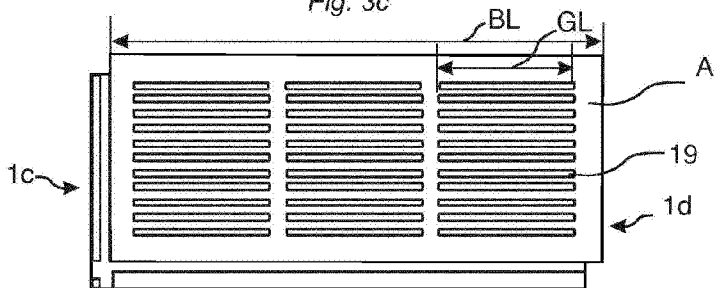

Fig. 3d

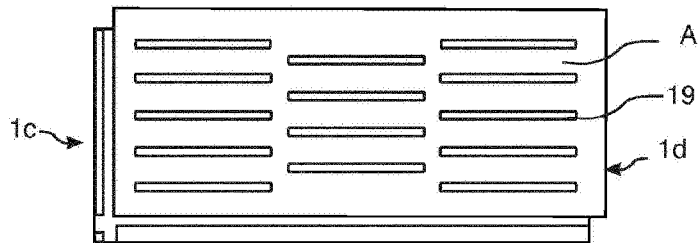

Fig. 3e

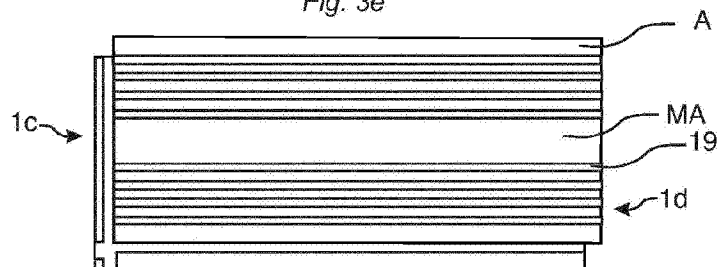

Fig. 4a

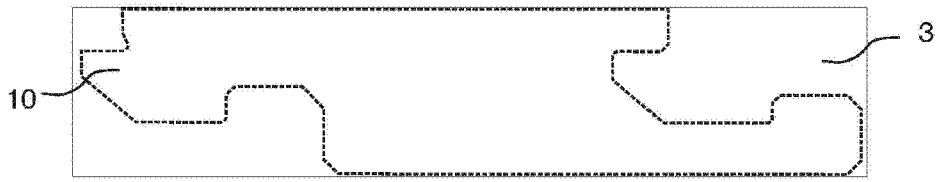

Fig. 4b

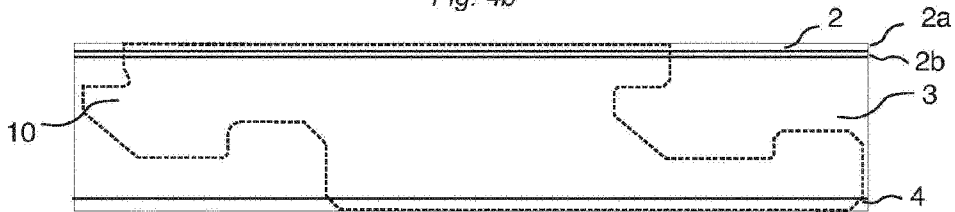

Fig. 4c

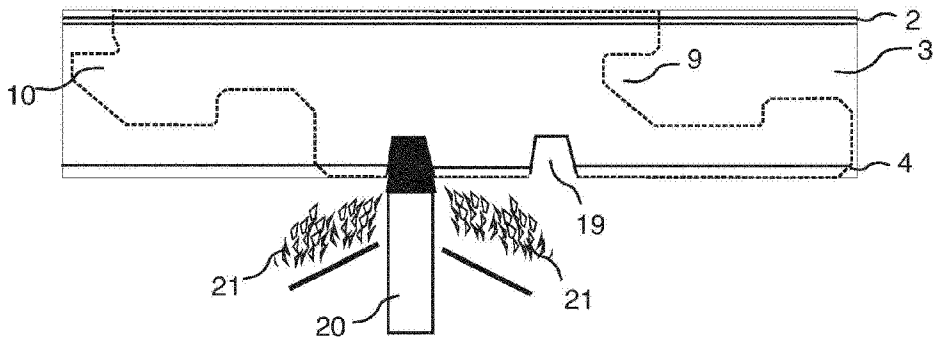
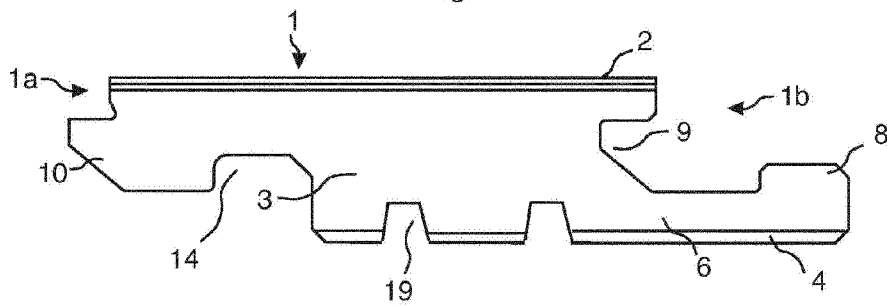

Fig. 4d



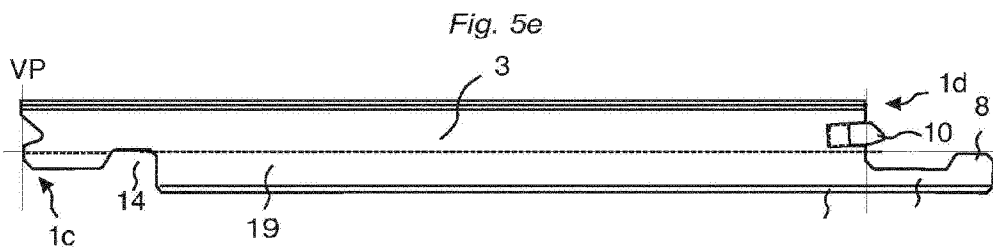
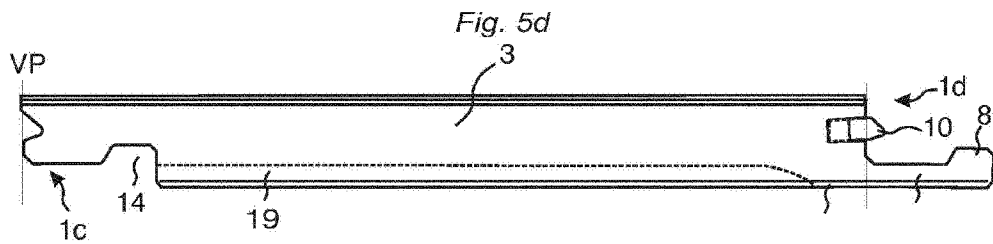
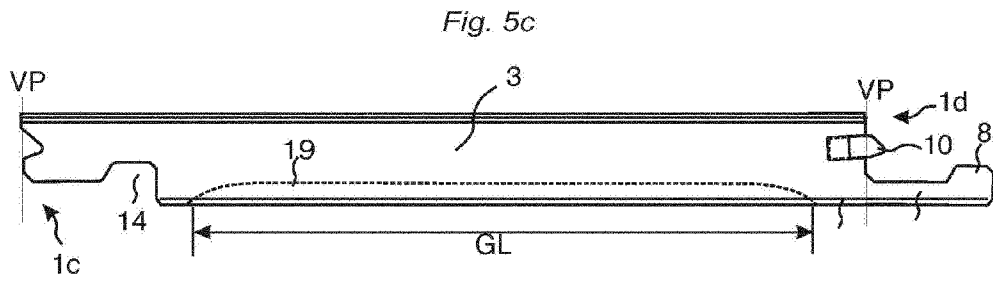
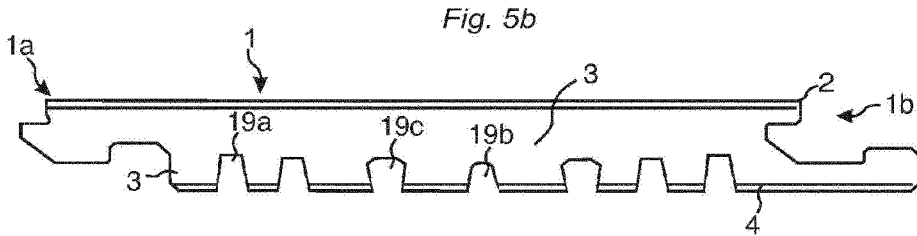
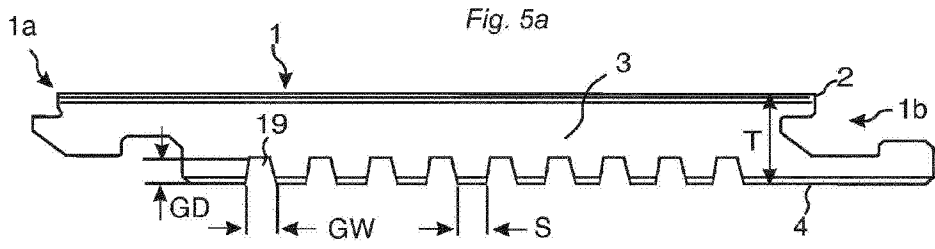

Fig. 6a

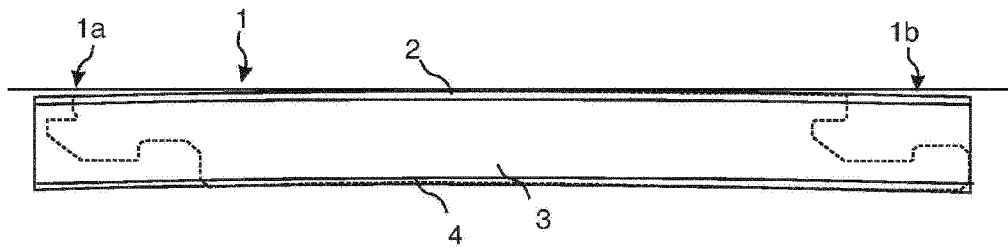

Fig. 6b

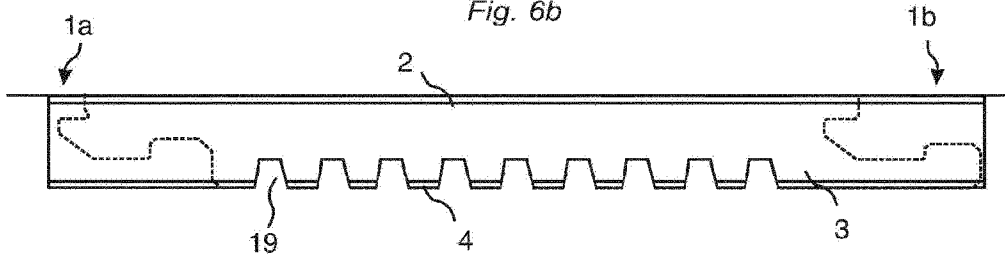

Fig. 6c

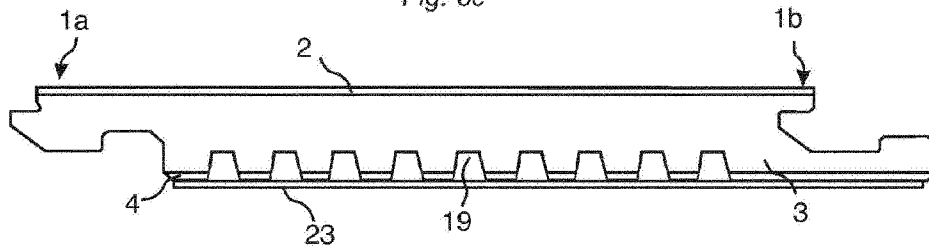

Fig. 6d

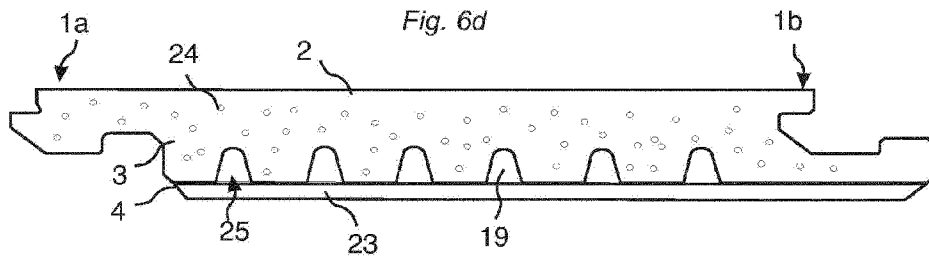

Fig. 6e

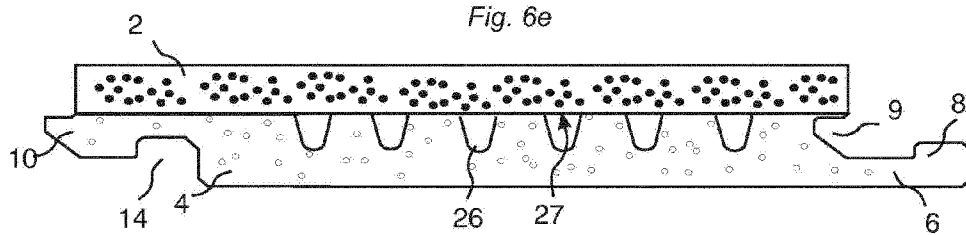

Fig.7a

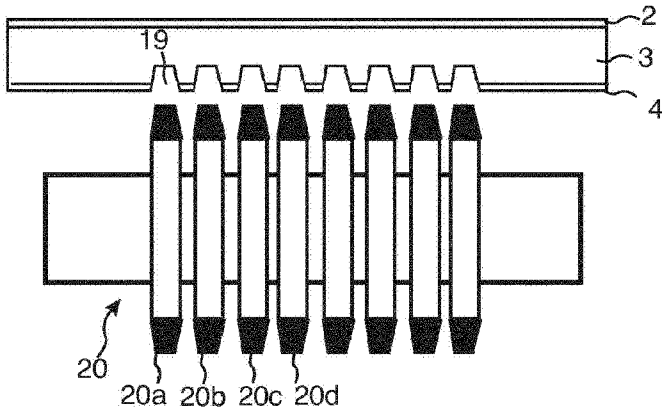

Fig.7b

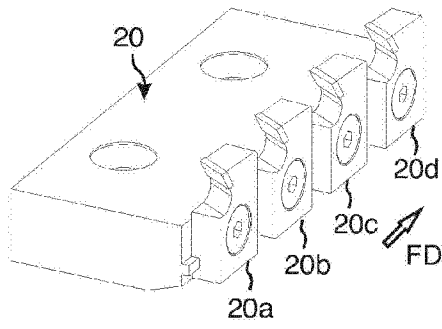

Fig.7c

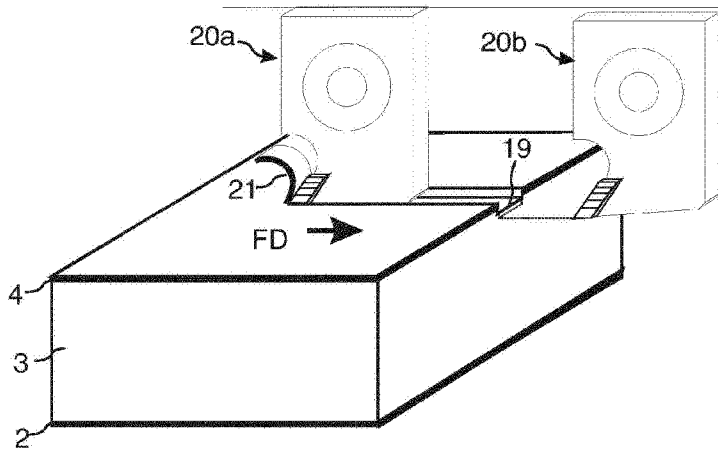

Fig. 8a

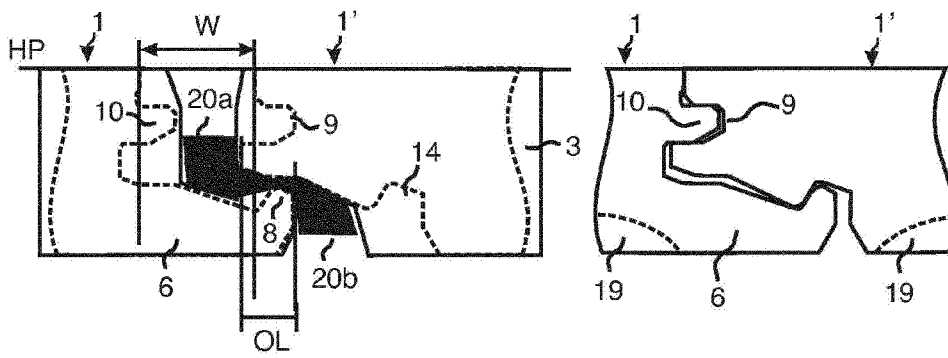

Fig. 8b

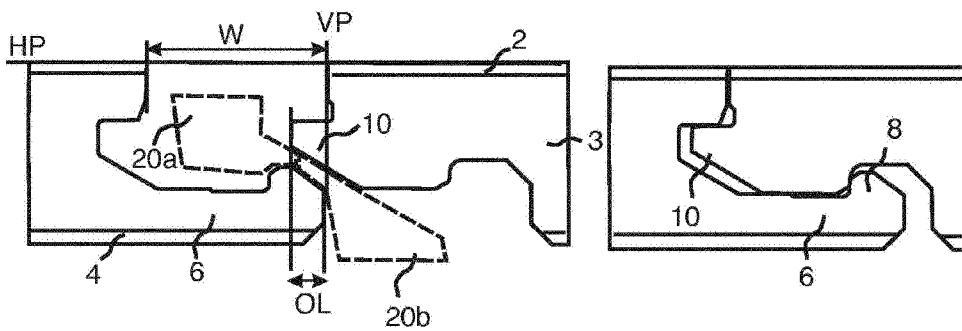

Fig. 8c

