



US00D545593S

(12) **United States Design Patent**  
**Wheeler**

(10) **Patent No.:** **US D545,593 S**

(45) **Date of Patent:** **\*\* Jul. 3, 2007**

(54) **CONSOLE**

(75) Inventor: **Giles Christopher Wheeler**, Solihull (GB)

(73) Assignee: **Sefour Limited**, Solihull (GB)

(\*\*) Term: **14 Years**

(21) Appl. No.: **29/251,979**

(22) Filed: **Jan. 17, 2006**

(51) **LOC (8) Cl.** ..... **06-04**

(52) **U.S. Cl.** ..... **D6/478**

(58) **Field of Classification Search** ..... D6/477-479,  
D6/436, 560, 409-411; 211/189-190, 194,  
211/188, 187; 312/111, 108; 217/36; D18/59  
See application file for complete search history.

(56) **References Cited**

**U.S. PATENT DOCUMENTS**

- D139,708 S \* 12/1944 Lapin ..... D6/336
- D285,852 S \* 9/1986 Clark ..... D34/21
- D311,291 S \* 10/1990 Ugalde ..... D6/474
- D365,709 S \* 1/1996 Leveen et al. .... D6/474
- D374,135 S \* 10/1996 Lladro Roig et al. .... D6/436

- D396,376 S \* 7/1998 Sze-Man ..... D6/630
- D414,069 S \* 9/1999 Fok ..... D6/630
- D425,727 S \* 5/2000 Ishikawa ..... D6/425
- 7,083,056 B2 \* 8/2006 Routhier ..... 211/90.04

\* cited by examiner

*Primary Examiner*—Cathron C. Brooks  
*Assistant Examiner*—Kelley A. Donnelly

(57) **CLAIM**

The ornamental design for the console, as shown and described.

**DESCRIPTION**

- FIG. 1 is a perspective view of my console;
- FIG. 2 is a back view of my console;
- FIG. 3 is a front view of my console;
- FIG. 4 is left side view of my console;
- FIG. 5 is a right side view of my console;
- FIG. 6 is a top view of my console; and,
- FIG. 7 is a bottom view of my console.

**1 Claim, 7 Drawing Sheets**

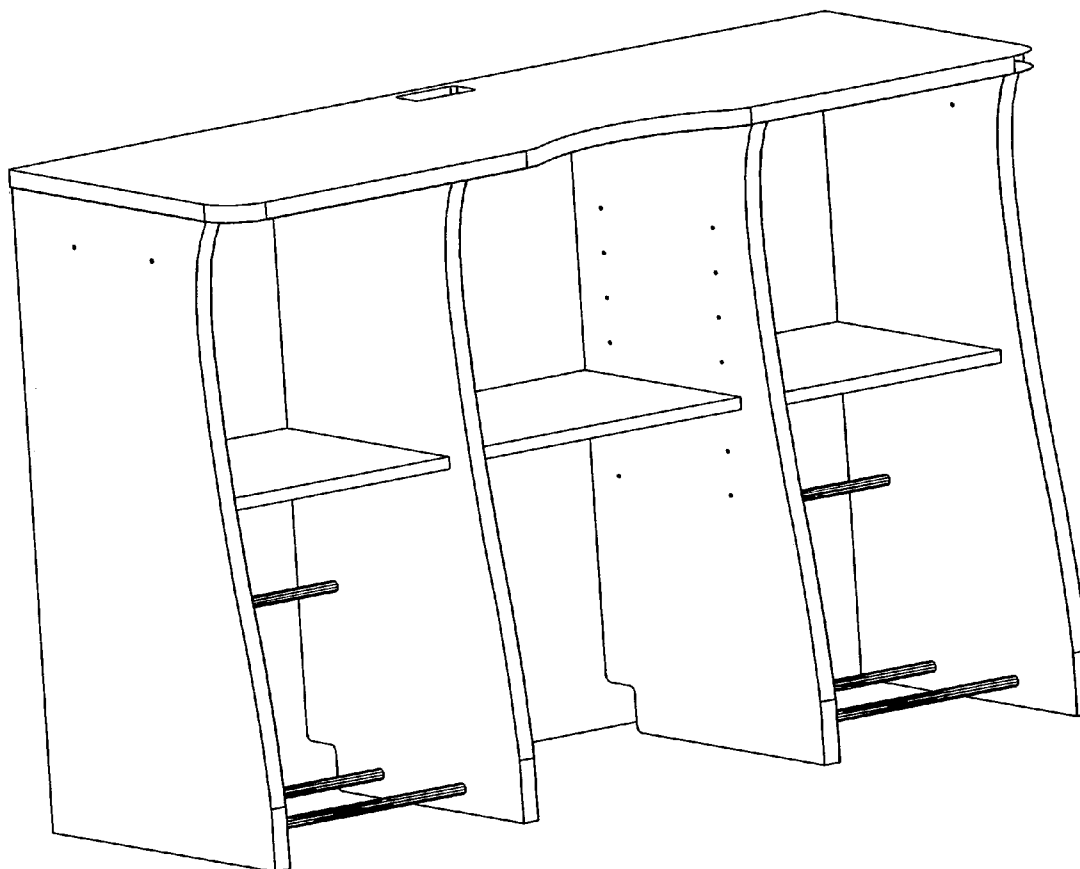

Figure 1

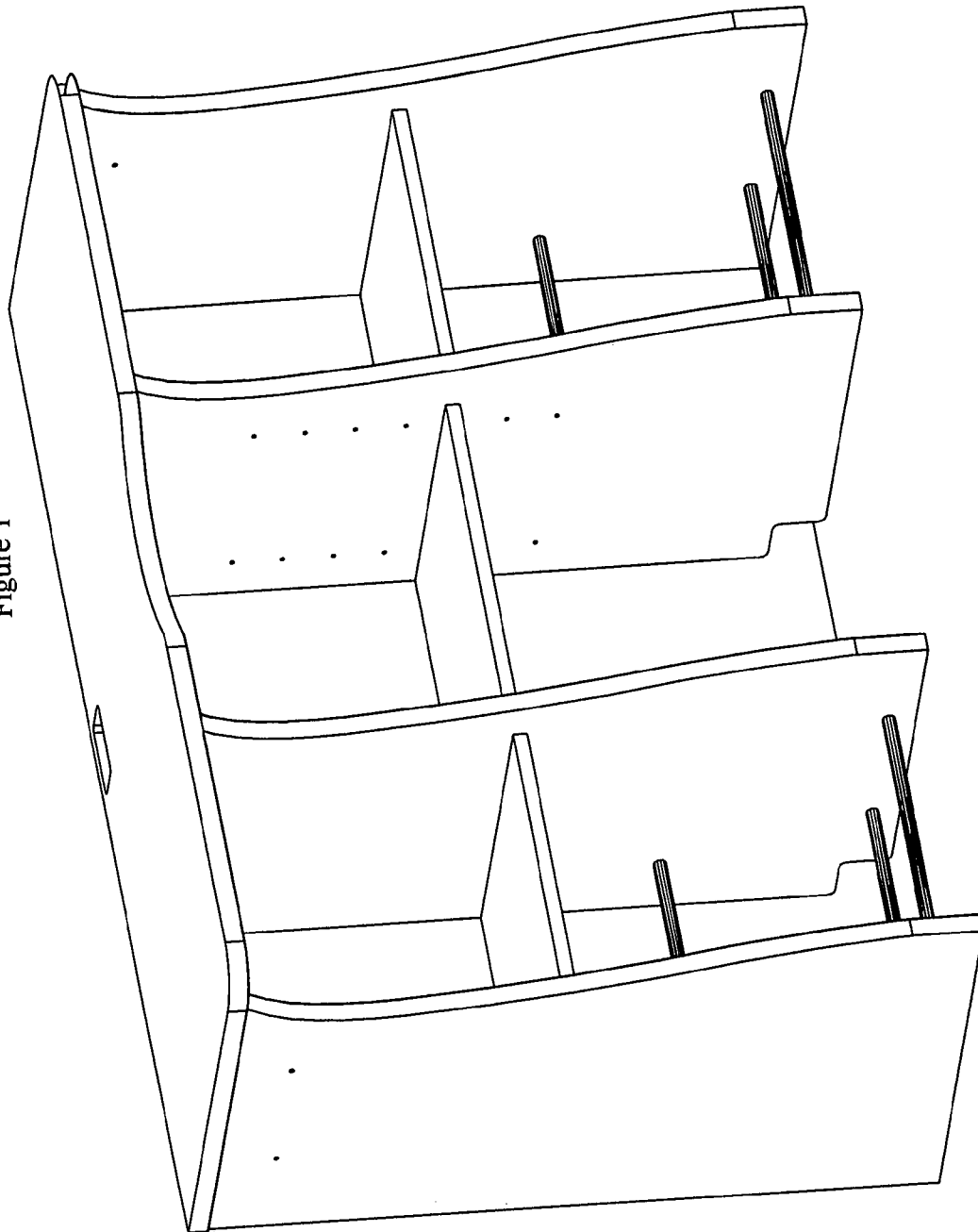

Figure 2

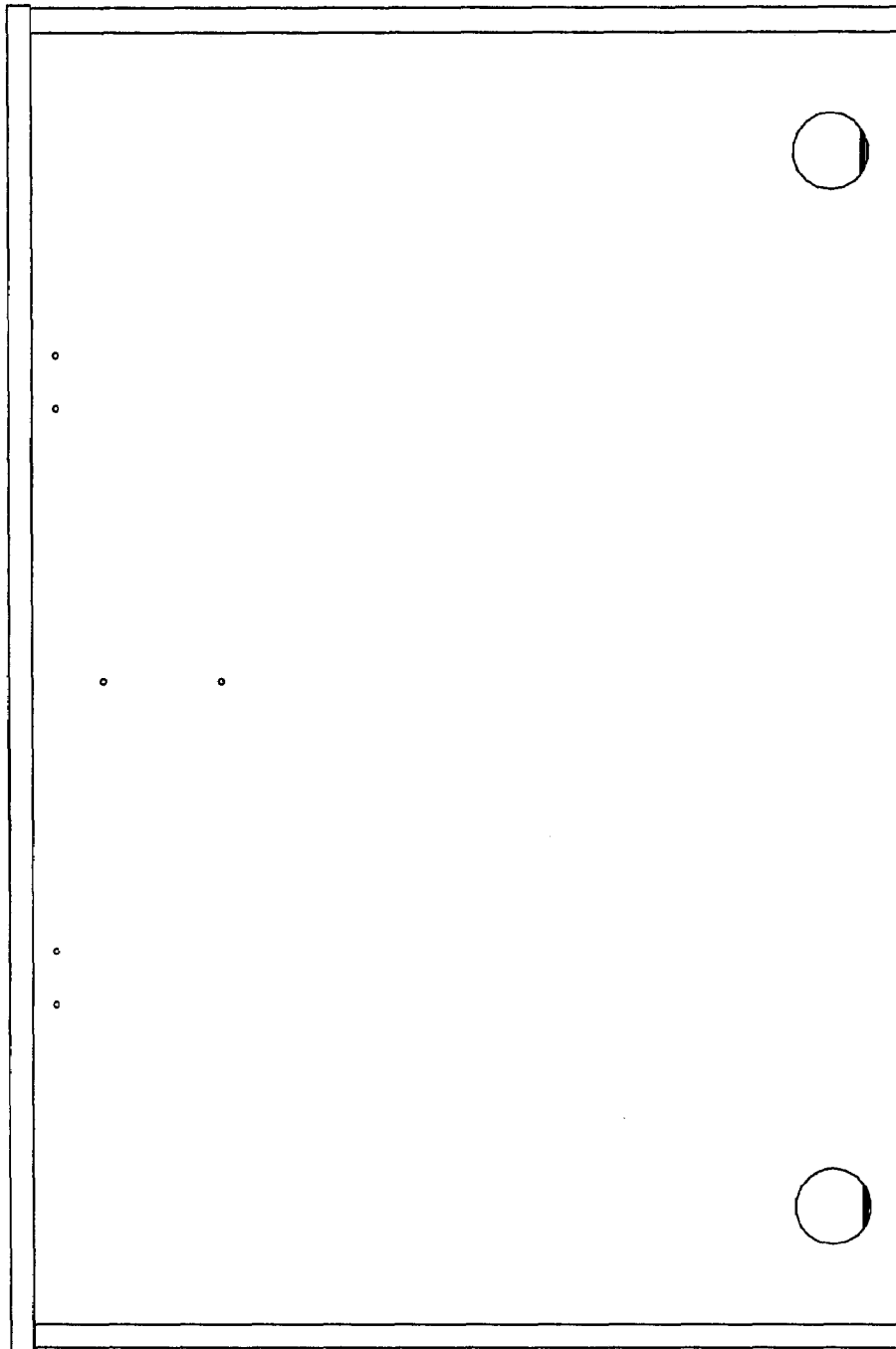

Figure 3

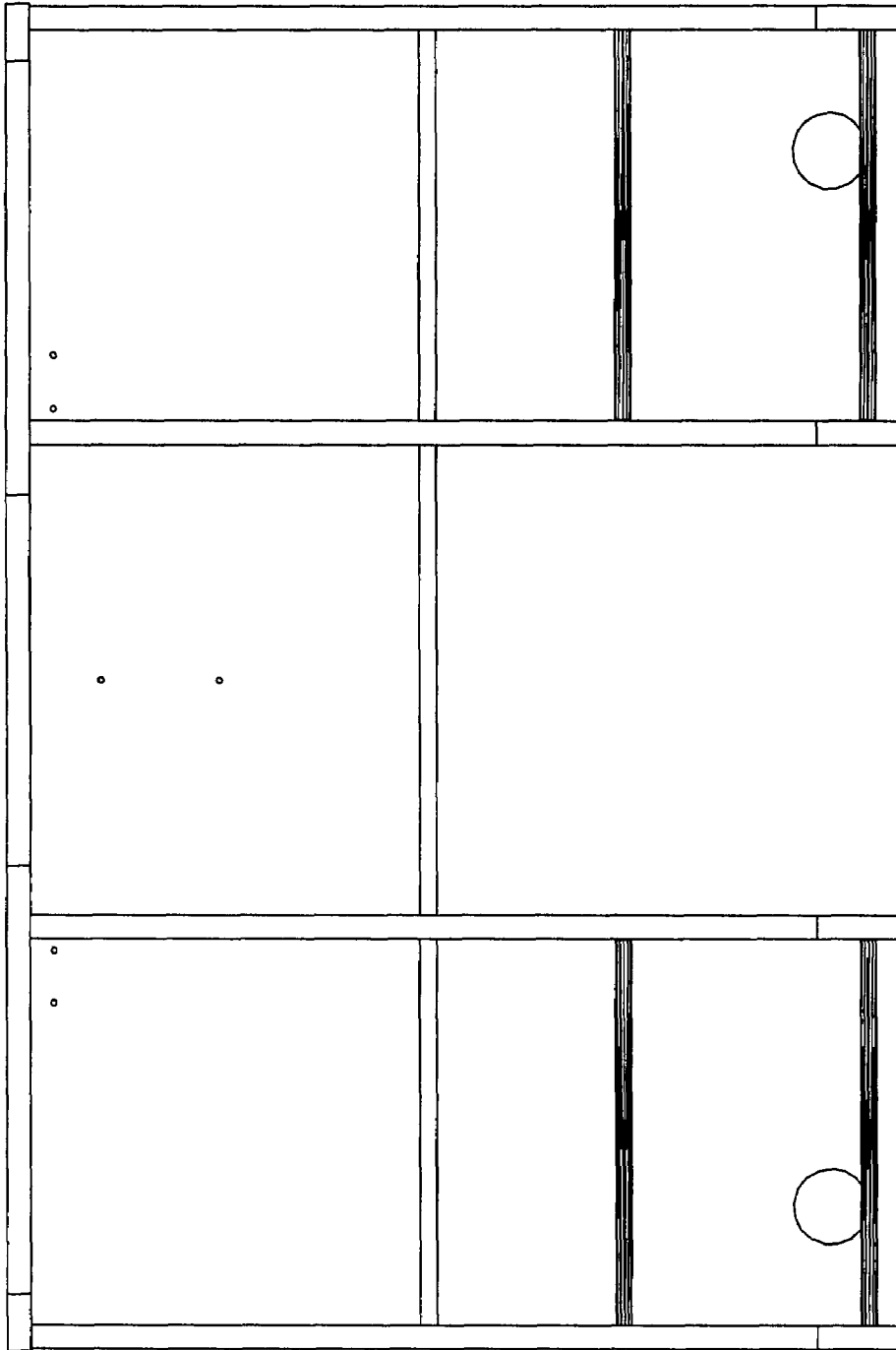

Figure 4

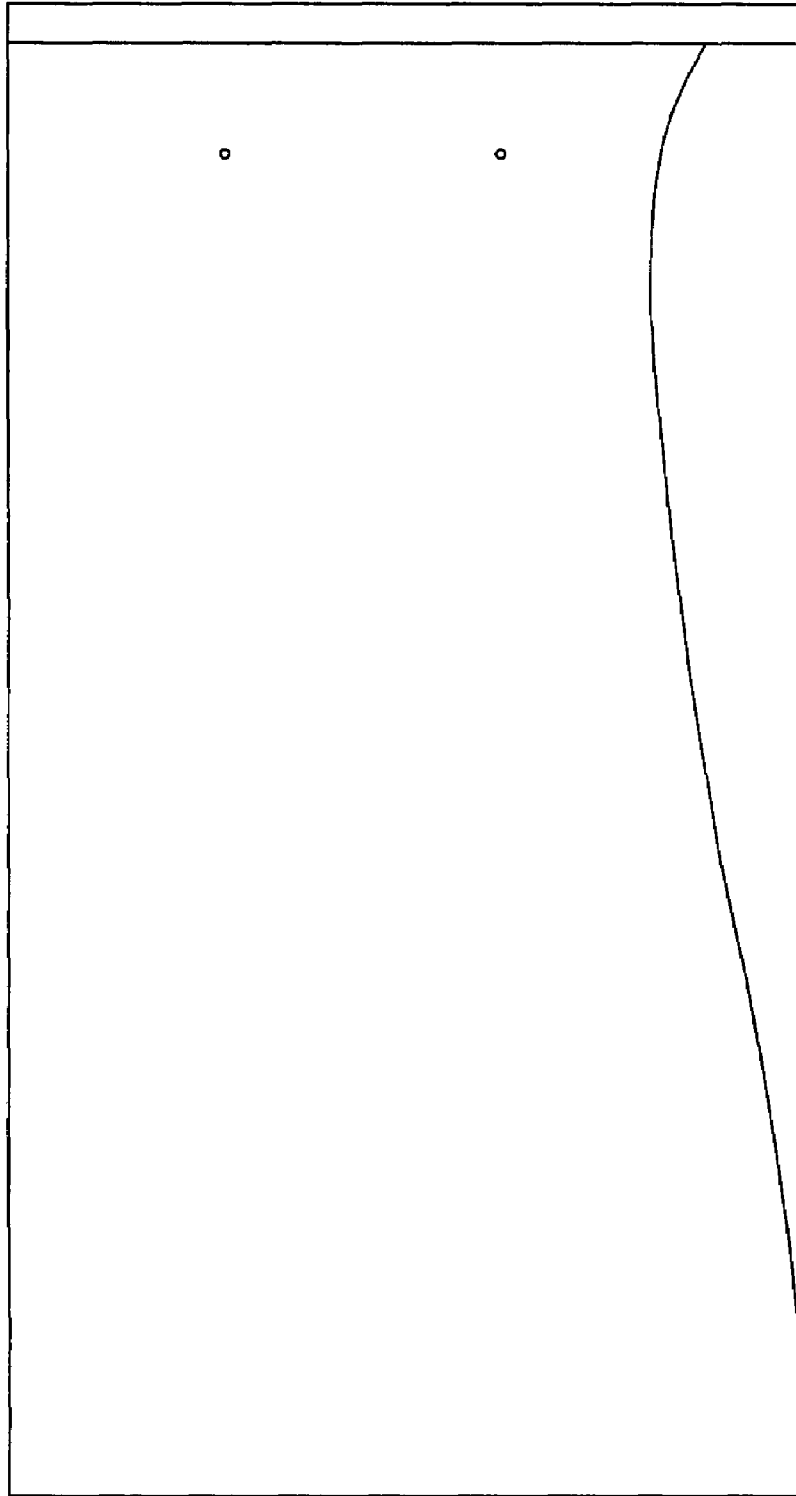

Figure 5

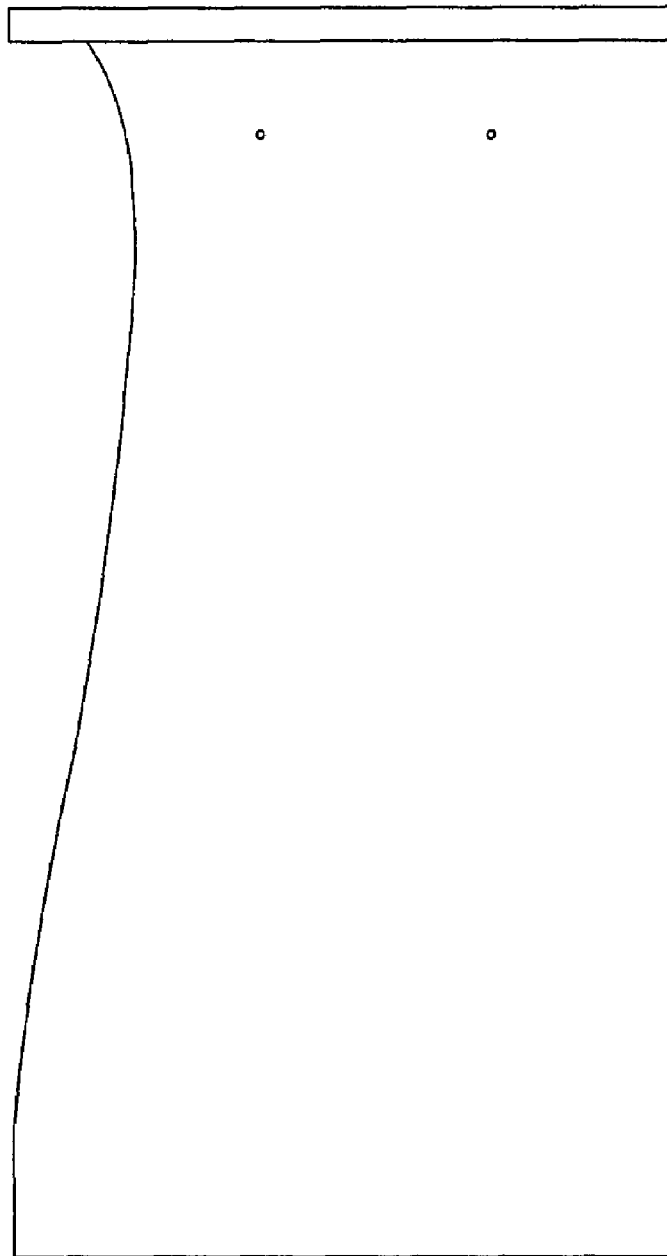

Figure 6

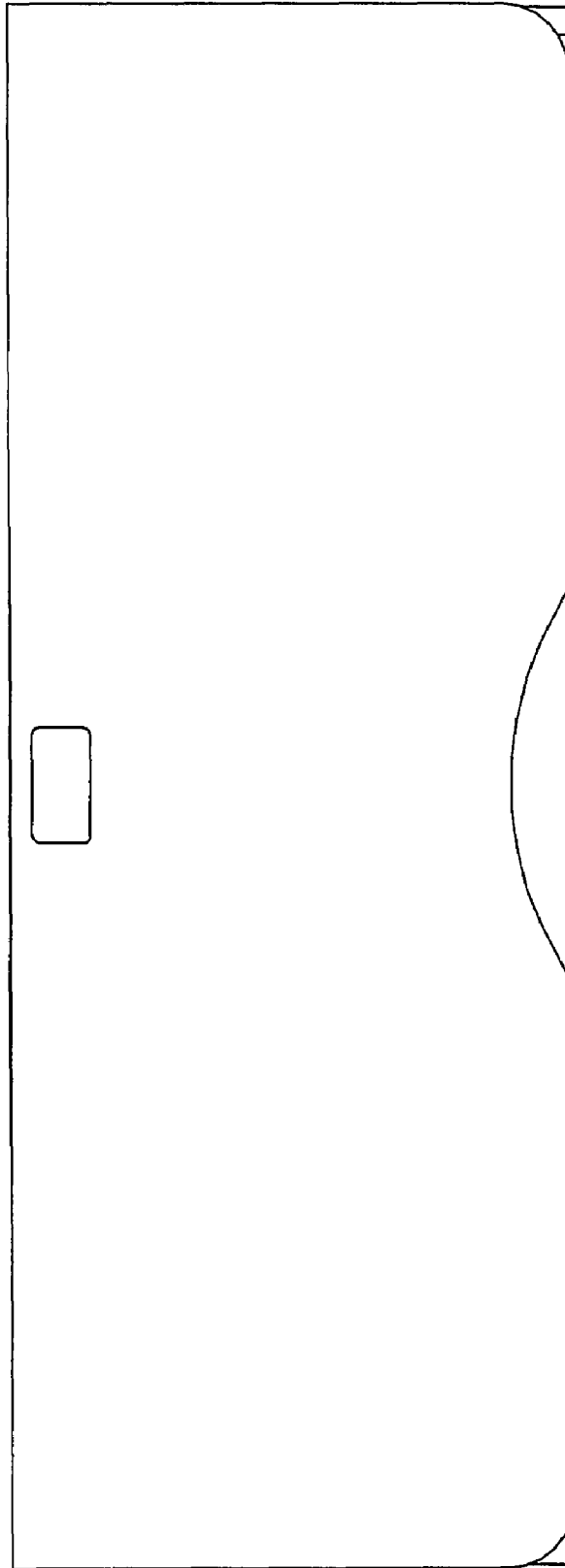

Figure 7

