



US00D744347S

(12) **United States Design Patent**
Llewellyn et al.

(10) **Patent No.:** **US D744,347 S**

(45) **Date of Patent:** **** Dec. 1, 2015**

(54) **BOTTLE**
(71) Applicant: **Robinsons Soft Drinks Limited**, Hemel Hempstead (GB)

(72) Inventors: **Tim Llewellyn**, London (GB); **Ines Sanchez-Calatrava**, London (GB)

(73) Assignee: **ROBINSONS SOFT DRINKS LIMITED**, Hemel Hempstead (GB)

(**) Term: **14 Years**

(21) Appl. No.: **29/434,085**

(22) Filed: **Oct. 9, 2012**

(30) **Foreign Application Priority Data**

May 4, 2012 (EP) 001325799

(51) **LOC (10) Cl.** **09-01**

(52) **U.S. Cl.**

USPC **D9/538**; D9/540; D9/550; D9/551; D9/552; D9/571; D9/449; D9/453; D9/454

(58) **Field of Classification Search**

USPC D9/516, 538, 539, 541, 551, 552, 558, D9/447, 449, 453, 454; D7/509, 510, 511; 215/382, 383, 384

See application file for complete search history.

(56) **References Cited**

U.S. PATENT DOCUMENTS

5,409,750	A	*	4/1995	Hamada et al.	428/35.7
D379,154	S	*	5/1997	Cox	D9/552 X
5,906,286	A	*	5/1999	Matsumo et al.	215/375
D427,071	S	*	6/2000	Williams et al.	D9/520
D453,686	S	*	2/2002	Petursdottir	D9/570
D466,415	S	*	12/2002	Reis	D9/552
D506,142	S	*	6/2005	Gauthier	D9/560
D515,427	S	*	2/2006	Schuller et al.	D9/516
D558,582	S	*	1/2008	Venkataraman et al.	D9/550
D561,598	S	*	2/2008	Dellevigne	D9/552 X

D570,691 S * 6/2008 Robbins et al. D9/516
D573,029 S * 7/2008 Venkataraman et al. D9/538
D601,906 S * 10/2009 Leruste D9/565 X

(Continued)

Primary Examiner — Carol P Rademaker

(74) *Attorney, Agent, or Firm* — Jean C. Edwards, Esq.;
Edwards Neils PLLC

(57) **CLAIM**

The ornamental design for a bottle, as shown and described.

DESCRIPTION

The patent or application file contains at least one drawing executed in color. Copies of this patent with color drawings will be provided by the Office upon request and payment of the necessary fee.

FIG. 1 is a front elevational view of a first embodiment of a bottle showing my new design;

FIG. 2 is a rear elevational view thereof;

FIG. 3 is a left side elevational view thereof;

FIG. 4 is a right side elevational view thereof;

FIG. 5 is a top plan view thereof;

FIG. 6 is a front elevational view of a second embodiment of the bottle showing my new design;

FIG. 7 is a rear elevational view thereof;

FIG. 8 is a left side elevational view thereof;

FIG. 9 is a right side elevational view thereof;

FIG. 10 is a top plan view thereof;

FIG. 11 is a front elevational view of a third embodiment of the bottle showing my new design;

FIG. 12 is a rear elevational view thereof;

FIG. 13 is a left side elevational view thereof;

FIG. 14 is a right side elevational view thereof;

FIG. 15 is a top plan view thereof;

FIG. 16 is a front elevational view of a fourth embodiment of the bottle showing my new design;

FIG. 17 is a rear elevational view thereof;

FIG. 18 is a left side elevational view thereof;

FIG. 19 is a right side elevational view thereof; and,

FIG. 20 is a top plan view thereof.

1 Claim, 20 Drawing Sheets
(20 of 20 Drawing Sheet(s) Filed in Color)

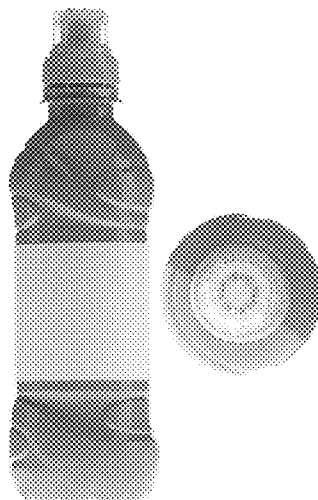

(56)

References Cited

U.S. PATENT DOCUMENTS

D612,733 S * 3/2010 Eugui et al. D9/516
D621,264 S * 8/2010 Williams D9/538 X
D623,951 S * 9/2010 Eugui et al. D9/516
D644,927 S * 9/2011 White et al. D9/516
D644,929 S * 9/2011 White et al. D9/540

D648,222 S * 11/2011 Snyder et al. D9/538
D682,700 S * 5/2013 White et al. D9/538
8,469,214 B2 * 6/2013 Boukobza 215/375
D699,580 S * 2/2014 Eaton et al. D9/537 X
D700,519 S * 3/2014 Eaton et al. D9/516
D719,449 S * 12/2014 Eaton et al. D9/516
8,905,253 B2 * 12/2014 Mooney 215/381

* cited by examiner

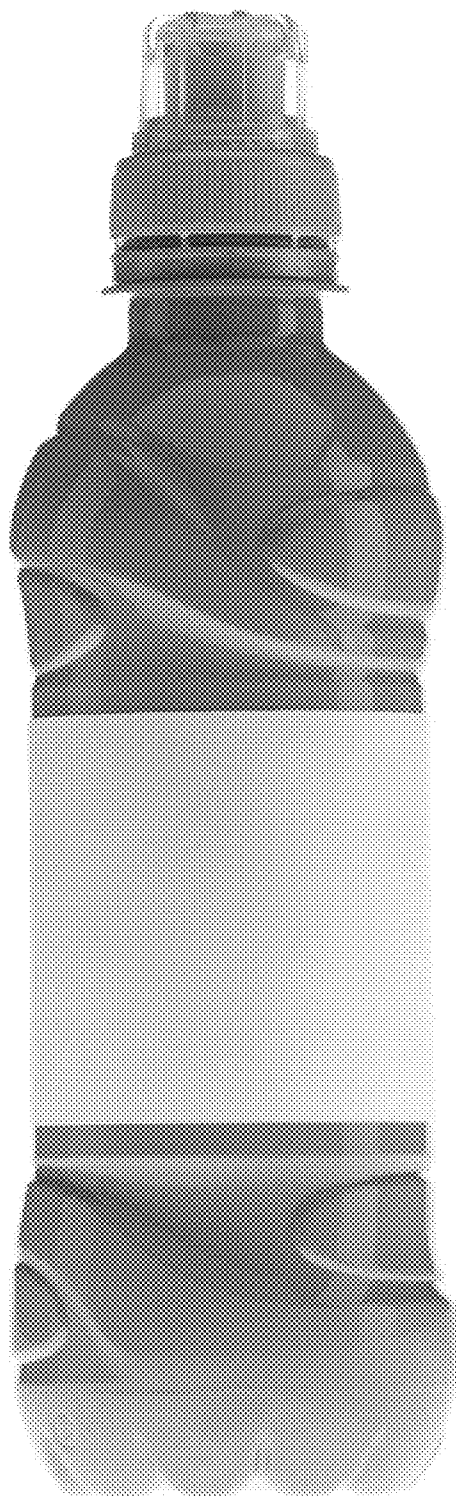

FIG. 1

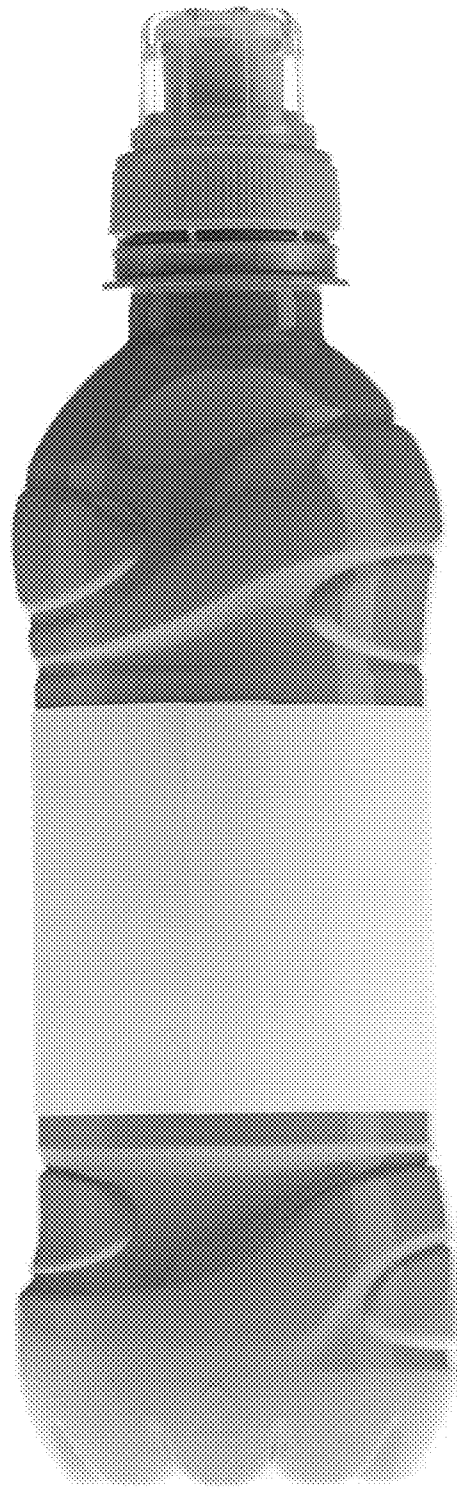

FIG. 2

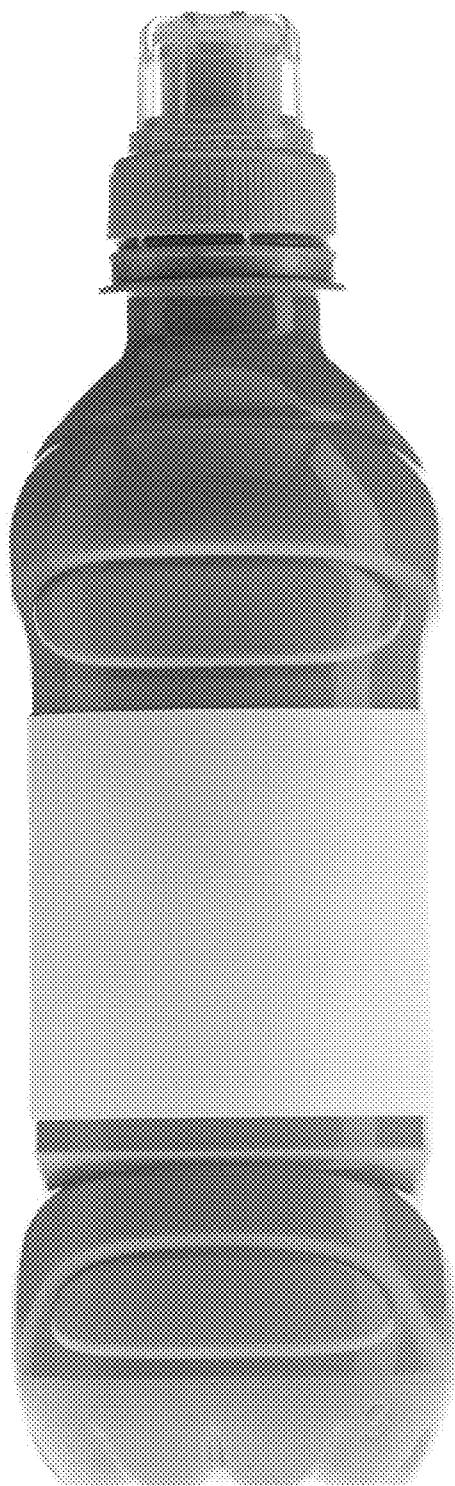

FIG. 3



FIG. 4

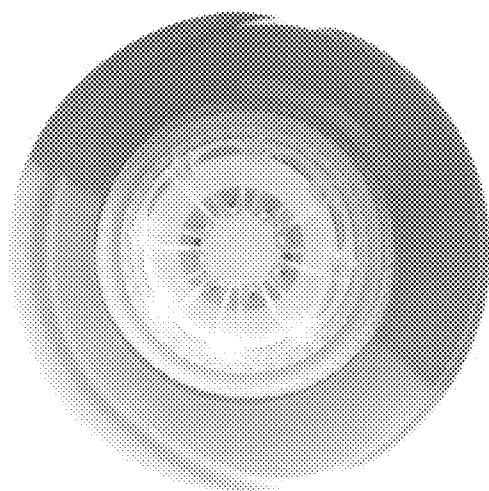

FIG. 5

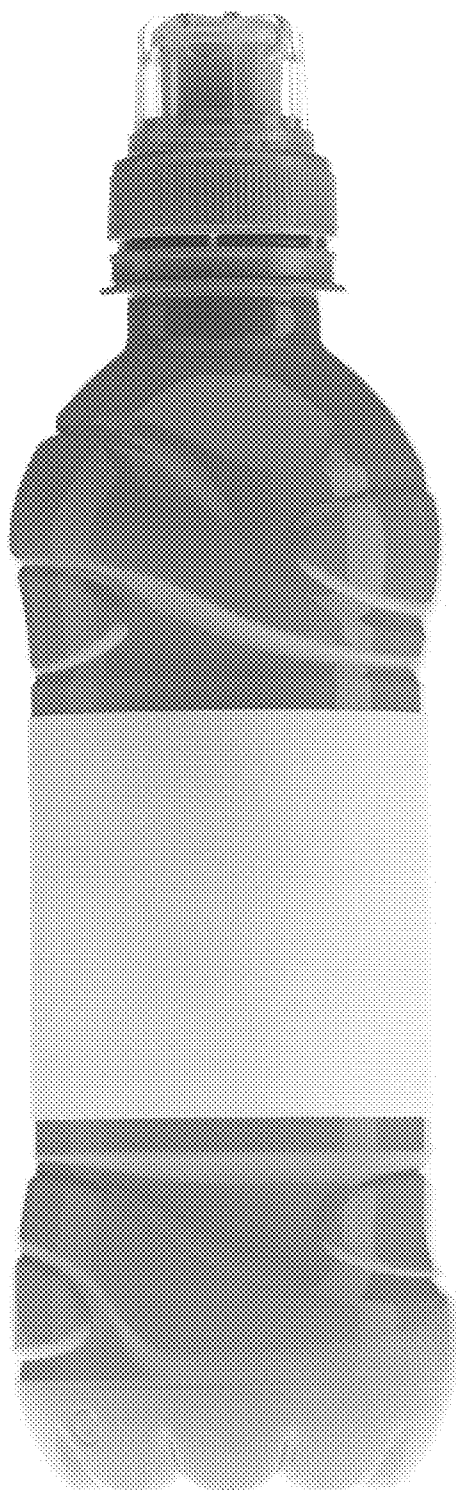

FIG. 6

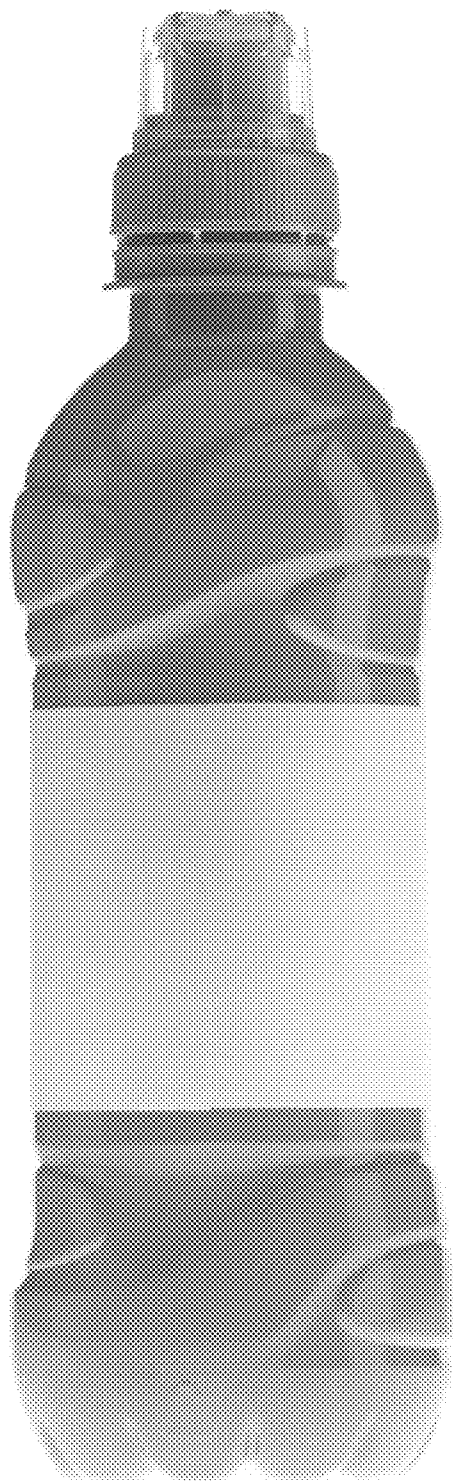

FIG. 7

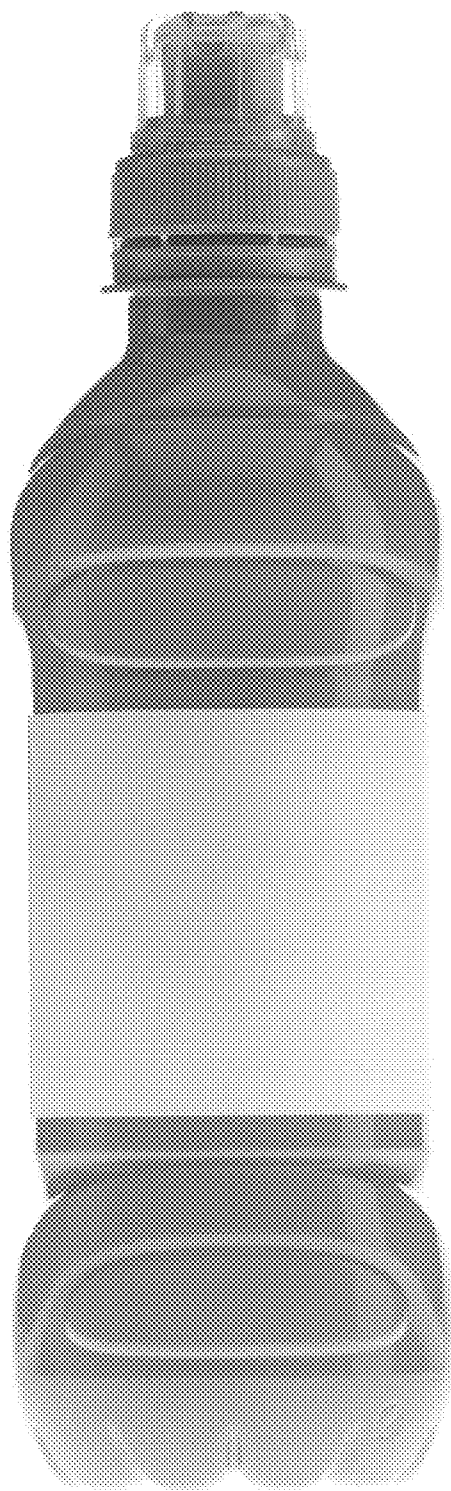

FIG. 8



FIG. 9

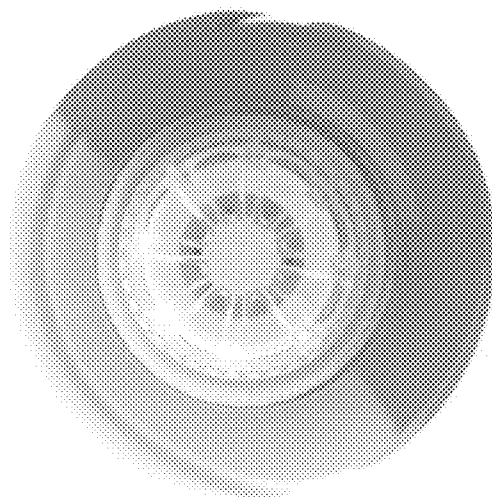

FIG. 10

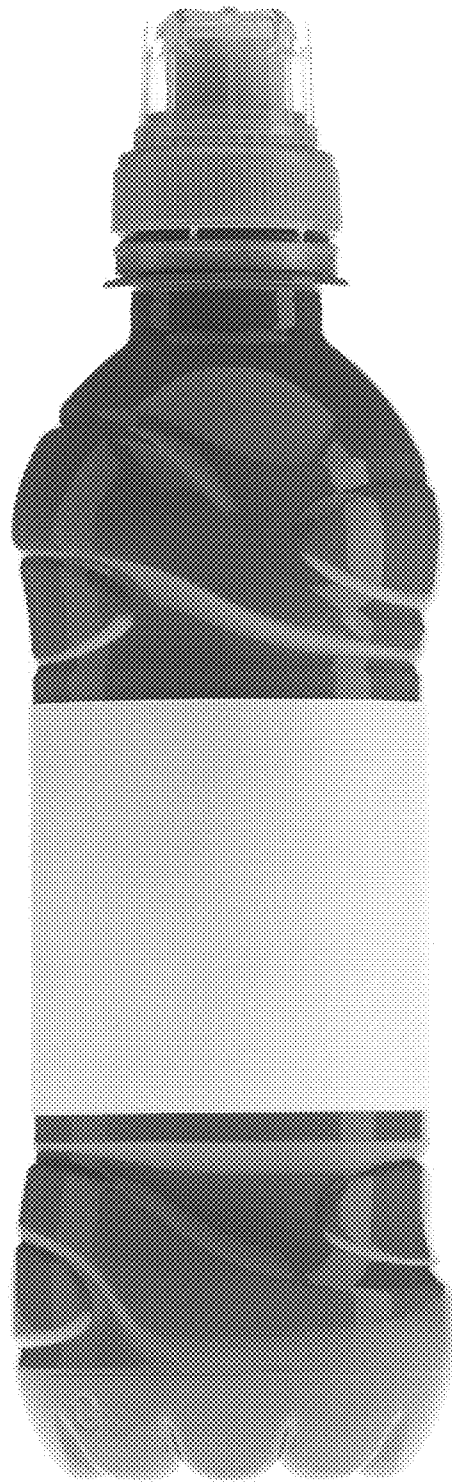

FIG. 11

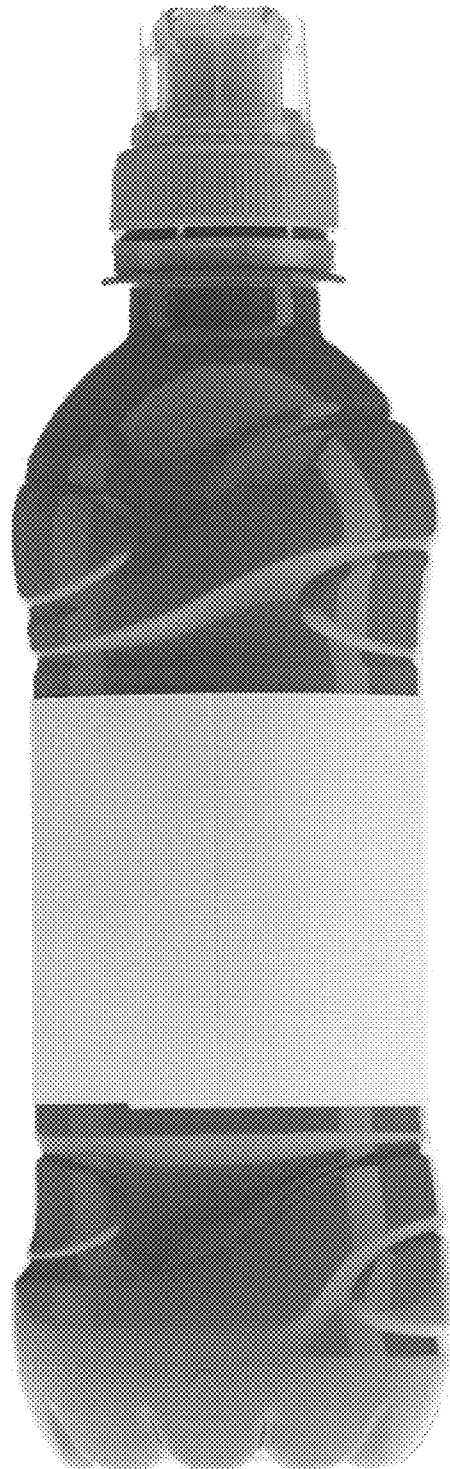

FIG. 12

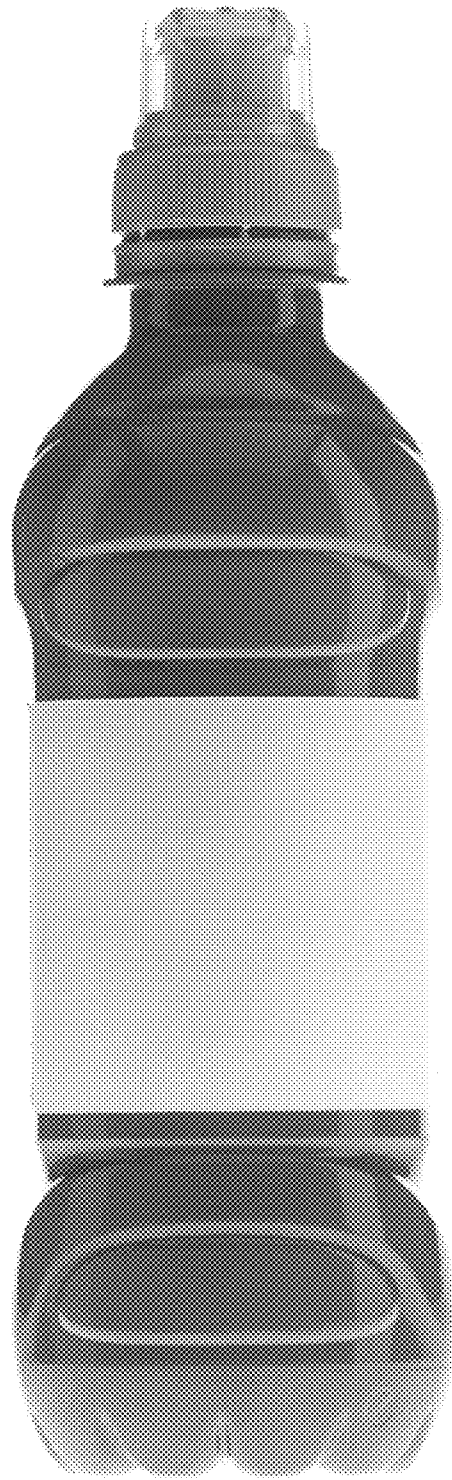

FIG. 13

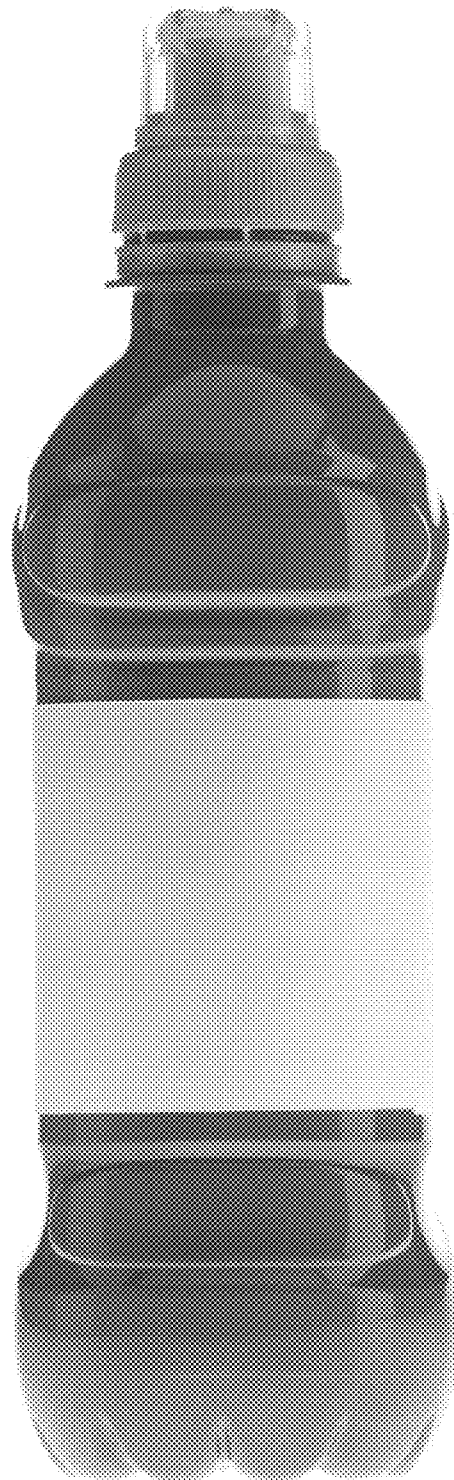

FIG. 14

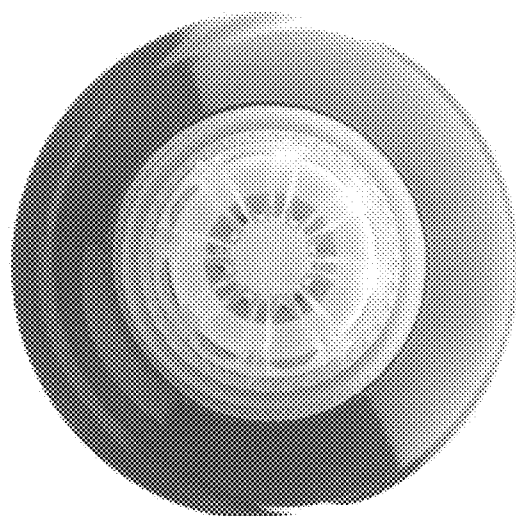

FIG. 15

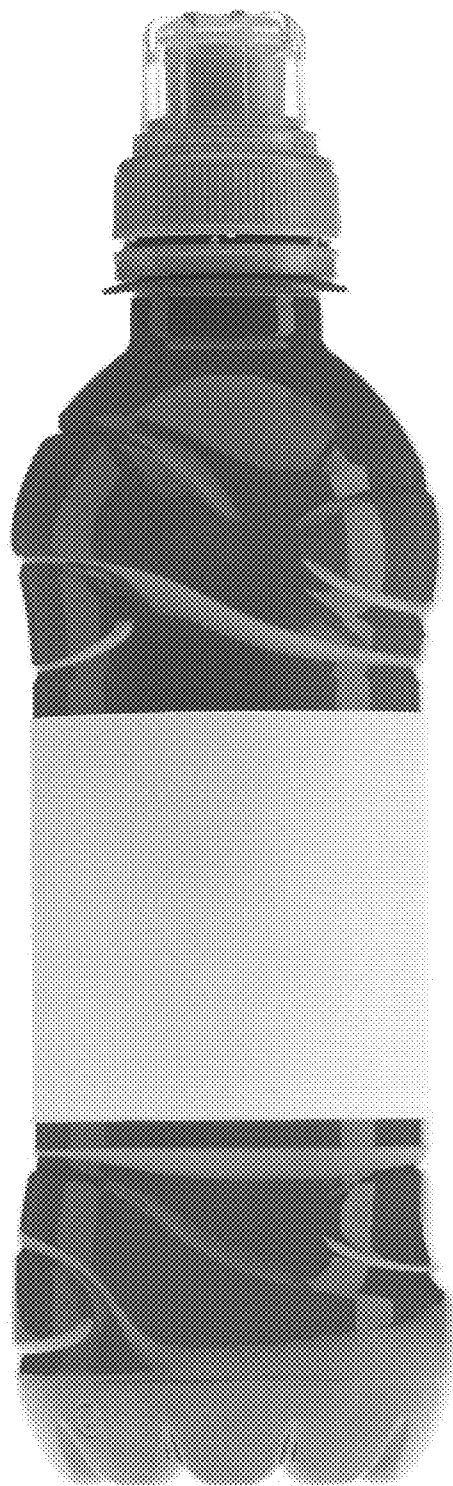

FIG. 16

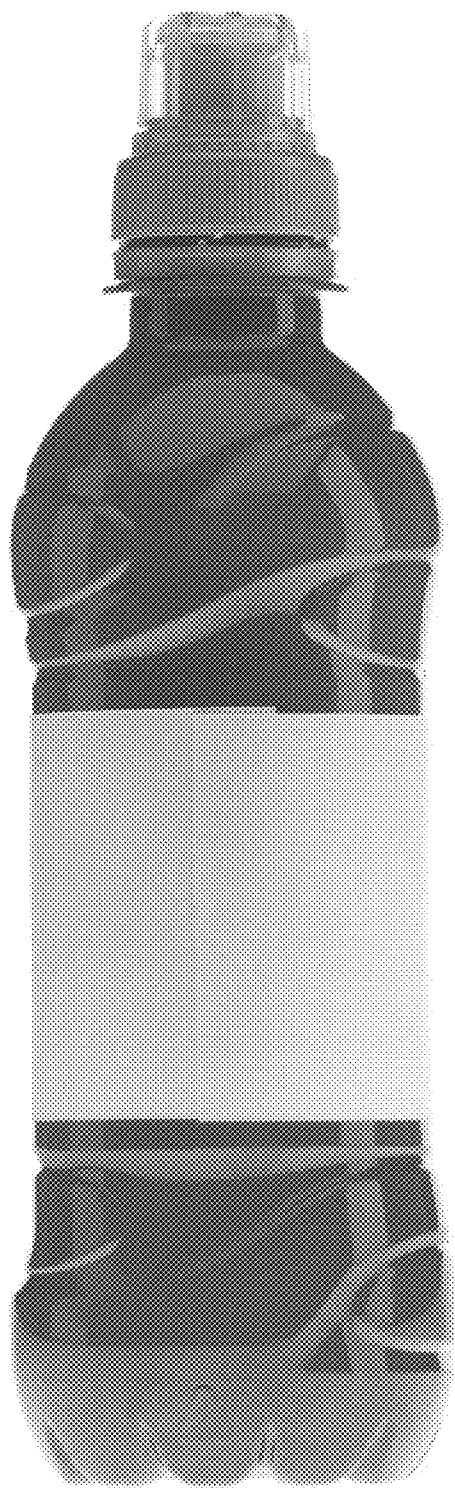

FIG. 17

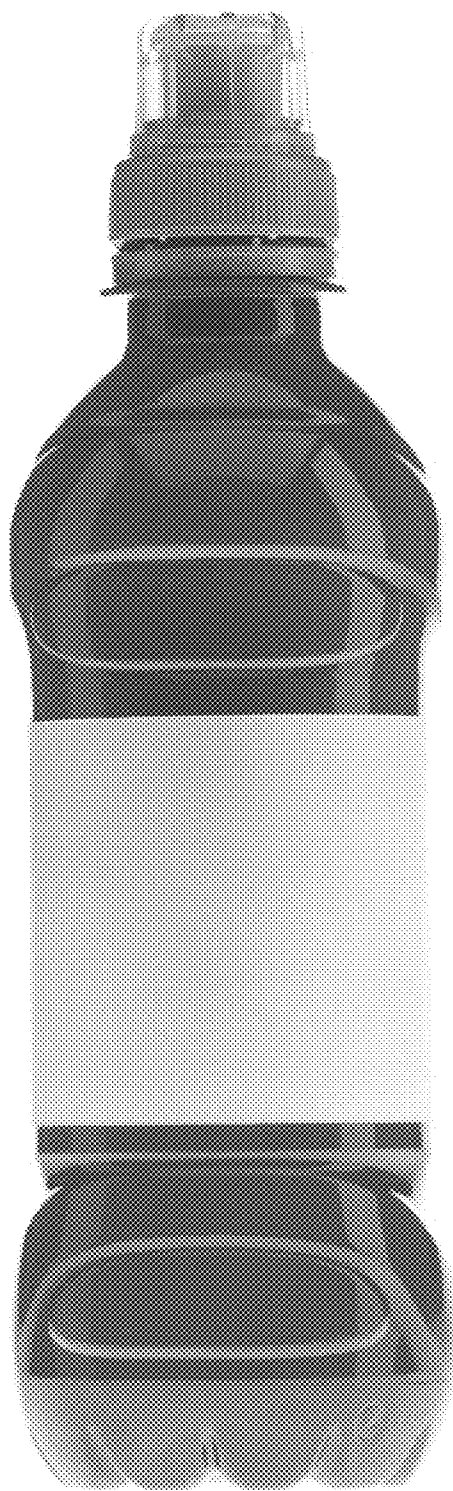

FIG. 18

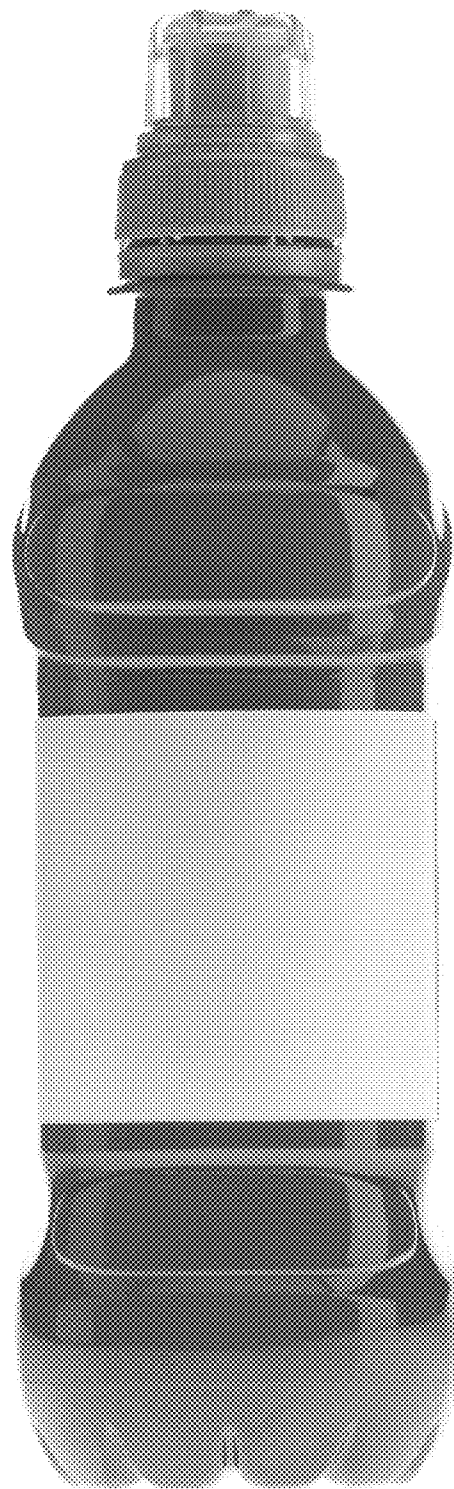

FIG. 19

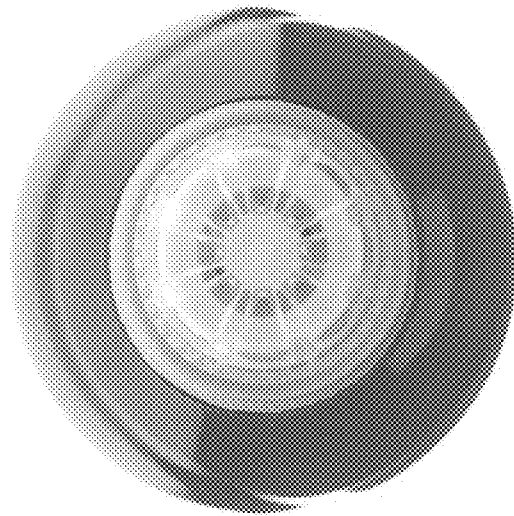

FIG. 20