



(86) Date de dépôt PCT/PCT Filing Date: 1997/07/31  
(87) Date publication PCT/PCT Publication Date: 1998/02/12  
(45) Date de délivrance/Issue Date: 2007/10/02  
(85) Entrée phase nationale/National Entry: 1999/02/05  
(86) N° demande PCT/PCT Application No.: US 1997/012834  
(87) N° publication PCT/PCT Publication No.: 1998/005672  
(30) Priorité/Priority: 1996/08/05 (US08/692,429)

(51) Cl.Int./Int.Cl. *C07H 23/00* (2006.01),  
*C07H 21/00* (2006.01), *C12P 19/34* (2006.01),  
*C12Q 1/68* (2006.01)  
(72) Inventeurs/Inventors:  
STOLOWITZ, MARK L., US;  
KAISER, ROBERT J., US  
(73) Propriétaire/Owner:  
CAMBREX BIO SCIENCE ROCKLAND, INC., US  
(74) Agent: FETHERSTONHAUGH & CO.

(54) Titre : NOUVEAUX ACIDES NUCLEIQUES CONTENANT DE L'ACIDE BORIQUE ET LEUR UTILISATION COMME AGENTS DIAGNOSTIQUES

(54) Title: NOVEL BORONIC ACID-CONTAINING NUCLEIC ACIDS AND THEIR USE AS DIAGNOSTIC AGENTS

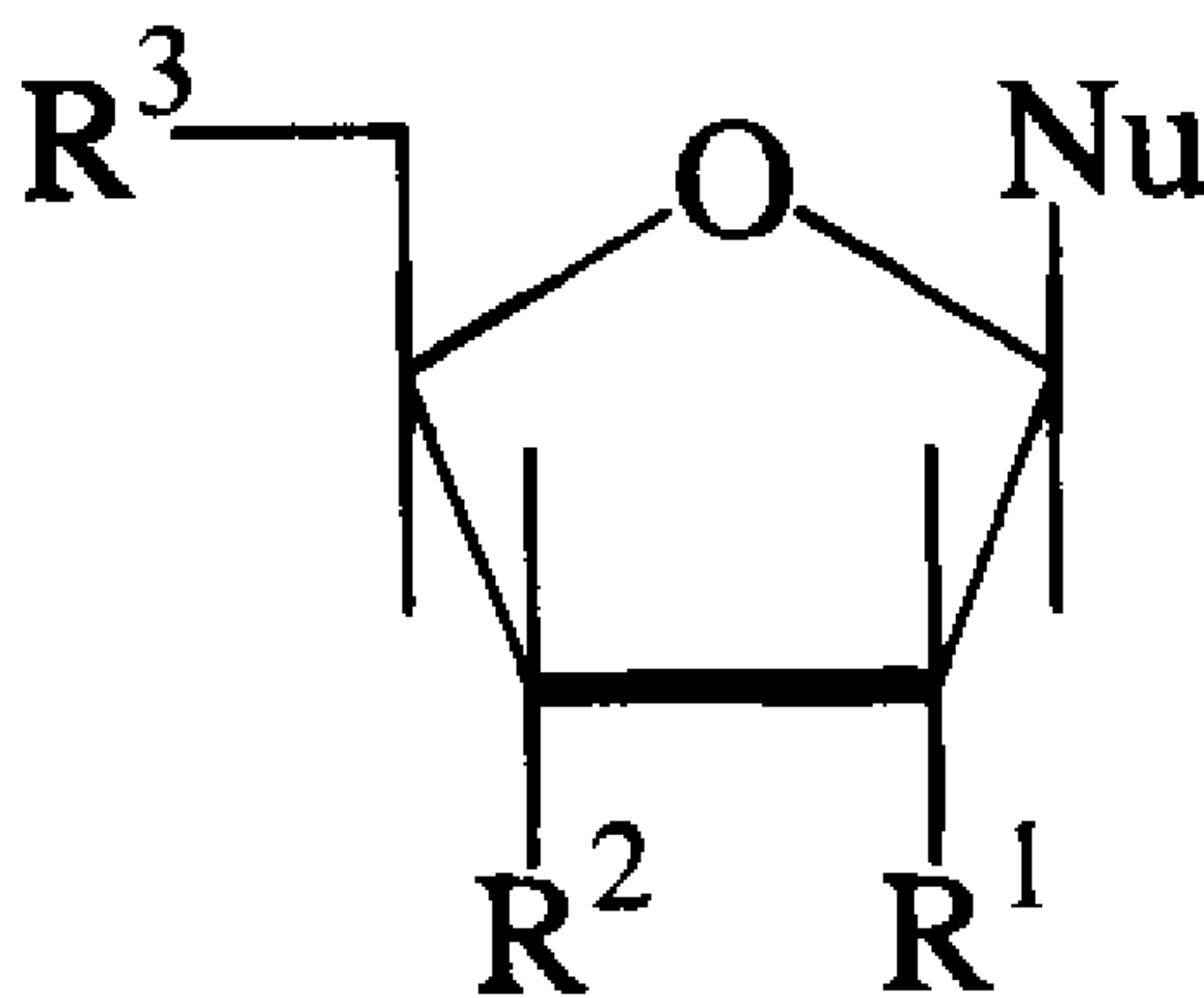

(57) Abrégé/Abstract:

Modified nucleotides and polynucleotides which are useful in hybridization assays for the detection of target genes are provided. The modified polynucleotides contain at least one boronic acid moiety which is attached to a nucleotide base in a position which does not interfere with the hydrogen bonding capabilities of that base during duplex formation. The modified polynucleotides are typically formed from naturally occurring nucleotides and one or more modified nucleotides.

**PCT**WORLD INTELLECTUAL PROPERTY ORGANIZATION  
International Bureau

## INTERNATIONAL APPLICATION PUBLISHED UNDER THE PATENT COOPERATION TREATY (PCT)

<b>(51) International Patent Classification <sup>6</sup> :</b> <b>C07H 1/00, C07G 3/00, C07H 15/00, 19/00, 21/02</b>	<b>A1</b>	<b>(11) International Publication Number: WO 98/05672</b> <b>(43) International Publication Date: 12 February 1998 (12.02.98)</b>
<b>(21) International Application Number:</b> PCT/US97/12834 <b>(22) International Filing Date:</b> 31 July 1997 (31.07.97) <b>(30) Priority Data:</b> 08/692,429                      5 August 1996 (05.08.96)                      US <b>(71) Applicant (for all designated States except US):</b> PROLINX INCORPORATED [US/US]; 22322 20th Avenue S.E., Bothell, WA 98021 (US). <b>(72) Inventors; and</b> <b>(75) Inventors/Applicants (for US only):</b> STOLOWITZ, Mark, L. [US/US]; 13818 217th Place N.E., Woodinville, WA 98072 (US). KAISER, Robert, J. [US/US]; 7804 N.E. 147th Street, Bothell, WA 98021 (US). <b>(74) Agents:</b> KEZER, William, B. et al.; Townsend and Townsend and Crew LLP, 8th floor, Two Embarcadero Center, San Francisco, CA 94111 (US).	<b>(81) Designated States:</b> AL, AM, AT, AU, AZ, BA, BB, BG, BR, BY, CA, CH, CN, CU, CZ, DE, DK, EE, ES, FI, GB, GE, GH, HU, IL, IS, JP, KE, KG, KP, KR, KZ, LC, LK, LR, LS, LT, LU, LV, MD, MG, MK, MN, MW, MX, NO, NZ, PL, PT, RO, RU, SD, SE, SG, SI, SK, SL, TJ, TM, TR, TT, UA, UG, US, UZ, VN, YU, ZW, ARIPO patent (GH, KE, LS, MW, SD, SZ, UG, ZW), Eurasian patent (AM, AZ, BY, KG, KZ, MD, RU, TJ, TM), European patent (AT, BE, CH, DE, DK, ES, FI, FR, GB, GR, IE, IT, LU, MC, NL, PT, SE), OAPI patent (BF, BJ, CF, CG, CI, CM, GA, GN, ML, MR, NE, SN, TD, TG).  <b>Published</b> <i>With international search report.</i>	
<b>(54) Title: NOVEL BORONIC ACID-CONTAINING NUCLEIC ACIDS AND THEIR USE AS DIAGNOSTIC AGENTS</b>		
<b>(57) Abstract</b>  Modified nucleotides and polynucleotides which are useful in hybridization assays for the detection of target genes are provided. The modified polynucleotides contain at least one boronic acid moiety which is attached to a nucleotide base in a position which does not interfere with the hydrogen bonding capabilities of that base during duplex formation. The modified polynucleotides are typically formed from naturally occurring nucleotides and one or more modified nucleotides.		

## NOVEL BORONIC ACID-CONTAINING NUCLEIC ACIDS AND THEIR USE AS DIAGNOSTIC AGENTS

5

### FIELD OF THE INVENTION

The present invention relates to the field of gene probe detection, and particularly to modified polynucleotides which are useful in the detection of target genes.

10

### BACKGROUND OF THE INVENTION

Nucleic acid hybridization tests for the detection of specific DNA and RNA sequences are now common in research and are becoming common in diagnostic applications. These hybridization tests typically involve the use of a labeled nucleic acid probe in such assay formats as dot blots, Southern blots, Northern blots, *in situ* hybridization, plaque hybridization and colony hybridization. A variety of labels have been used in these assays including, for example, radiolabels, chemiluminescent compounds, enzymes and fluorescent compounds.

15

Almost as diverse as the labels are the methods of attaching the label to the nucleic acid probe. Briefly, the attachment of labels to a nucleic acid probe can be

20

accomplished by either direct or indirect methods. Direct labeling is the result of attaching a label to a nucleic acid probe via a covalent linkage, typically prior to formation of a duplex. Alternatively, the label can be incorporated noncovalently into a duplex via intercalation. For indirect labeling, a hapten is attached to the nucleic acid probe, and later detected using a labeled specific binding protein.

One example of an indirect labeling system is the biotin-streptavidin system described in Langer, *et al.*, *Proc. Natl. Acad. Sci. USA* 78:6633-6637 (1981).

In this system, a biotin moiety is attached to a nucleic acid probe and detection is carried out using a labeled avidin or labeled streptavidin. Methods for the attachment of biotin to the 5-position of a pyrimidine (*e.g.*, uridine), the 8-position of a purine (*e.g.*, guanidine) and the 7-position of a deazapurine (*e.g.*, 7-deazaguanidine) have been described in U.S. Patent Nos. 4,711,955, 5,241,060, 5,328,824, 5,449,767 and 5,476,928.

While the biotin system is characterized by high sensitivity, an endogenous ubiquitous vitamin, vitamin H, is used as the modification group. This results in extraneous background signals, especially with biological samples.

Another indirect method involves the use of the hapten digoxigenin (see, Kessler, *et al.*, *Biol. Chem. Hoppe-Seyler* 371:917-965 (1990)). This system uses the digoxigenin and antibody fragments derived from sheep polyclonal antibodies against digoxigenin. This method is also characterized by subpicogram sensitivity, and circumvents the problem of extraneous background signal by using the cardenolide digoxigenin which occurs only in *Digitalis* plants. Nevertheless, digoxigenin is an expensive reagent.

What is needed in the art are new methods of indirect labeling of probe:nucleic acid hybrids which have broad applicability, do not suffer from extraneous background signals and which provide modified duplexes which can be rapidly purified by affinity methods. Surprisingly, the present invention provides such methods, as well as the monomers and modified nucleic acids which are employed therein.

## SUMMARY OF THE INVENTION

The present invention provides modified polynucleosides and polynucleotides which are useful in hybridization assays for the detection of target genes. The modified polynucleotides contain at least one boronic acid moiety which is attached to a nucleotide base in a position which does not interfere with the hydrogen bonding capabilities of that base during duplex formation. The modified polynucleotides are typically formed from naturally occurring nucleotides and one or more modified nucleotides having the formula:

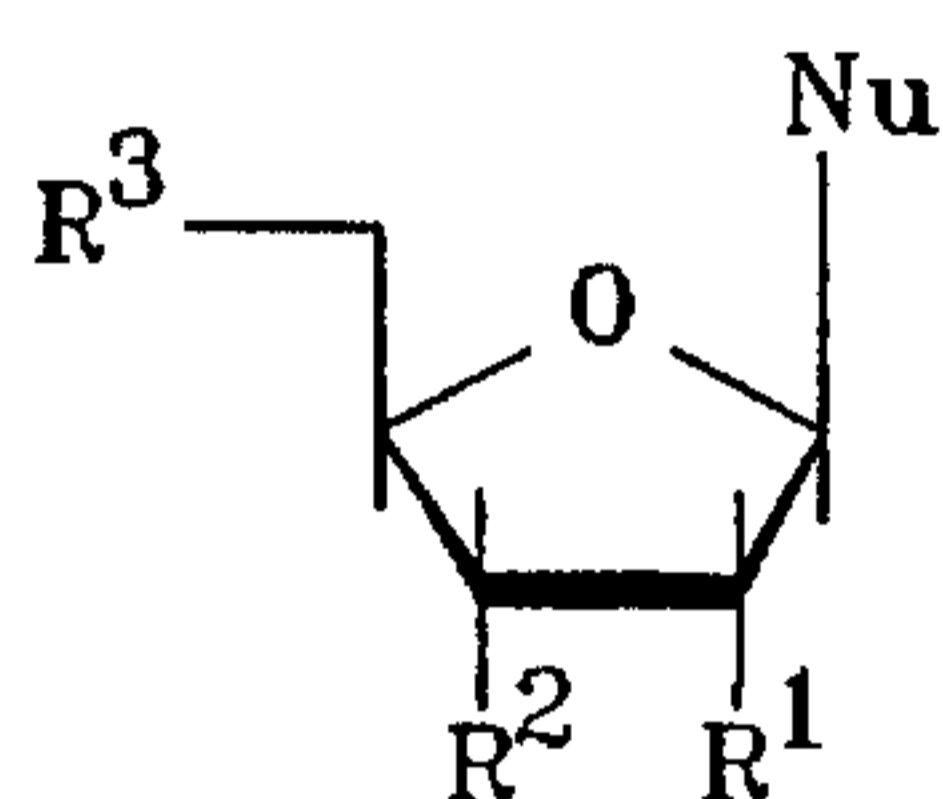

in which  $R^1$ ,  $R^2$  and  $R^3$  are each independently hydrogen, hydroxyl, protected hydroxyl, monophosphate ester, diphosphate ester, or triphosphate ester; Nu is a radical such as

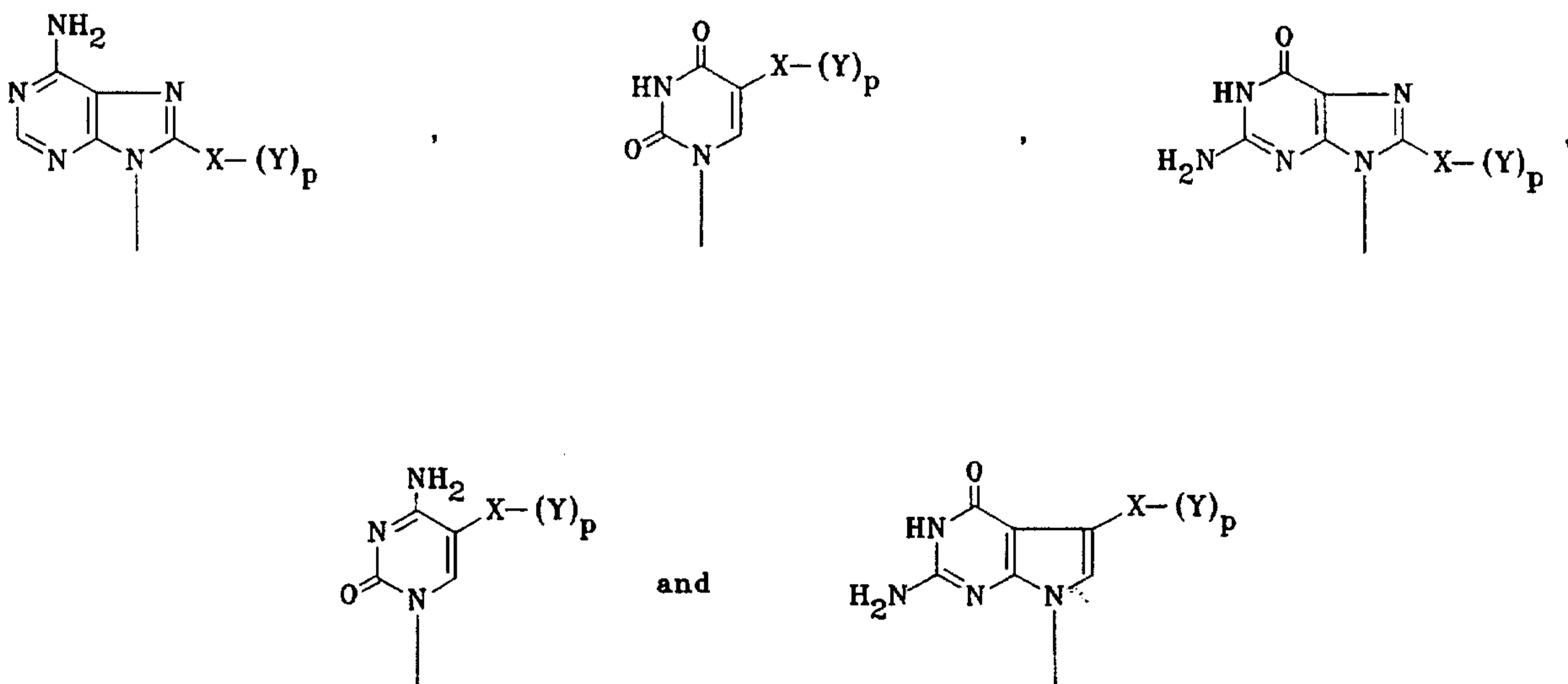

in which X is a linking group having from 7 to 30 carbon atoms, a portion of which is an aromatic ring; Y is a boron-containing moiety, preferably a boronic acid or boronic ester; and p is an integer of from 1 to 3.

The present invention further provides modified polynucleosides and polynucleotides having the formula:

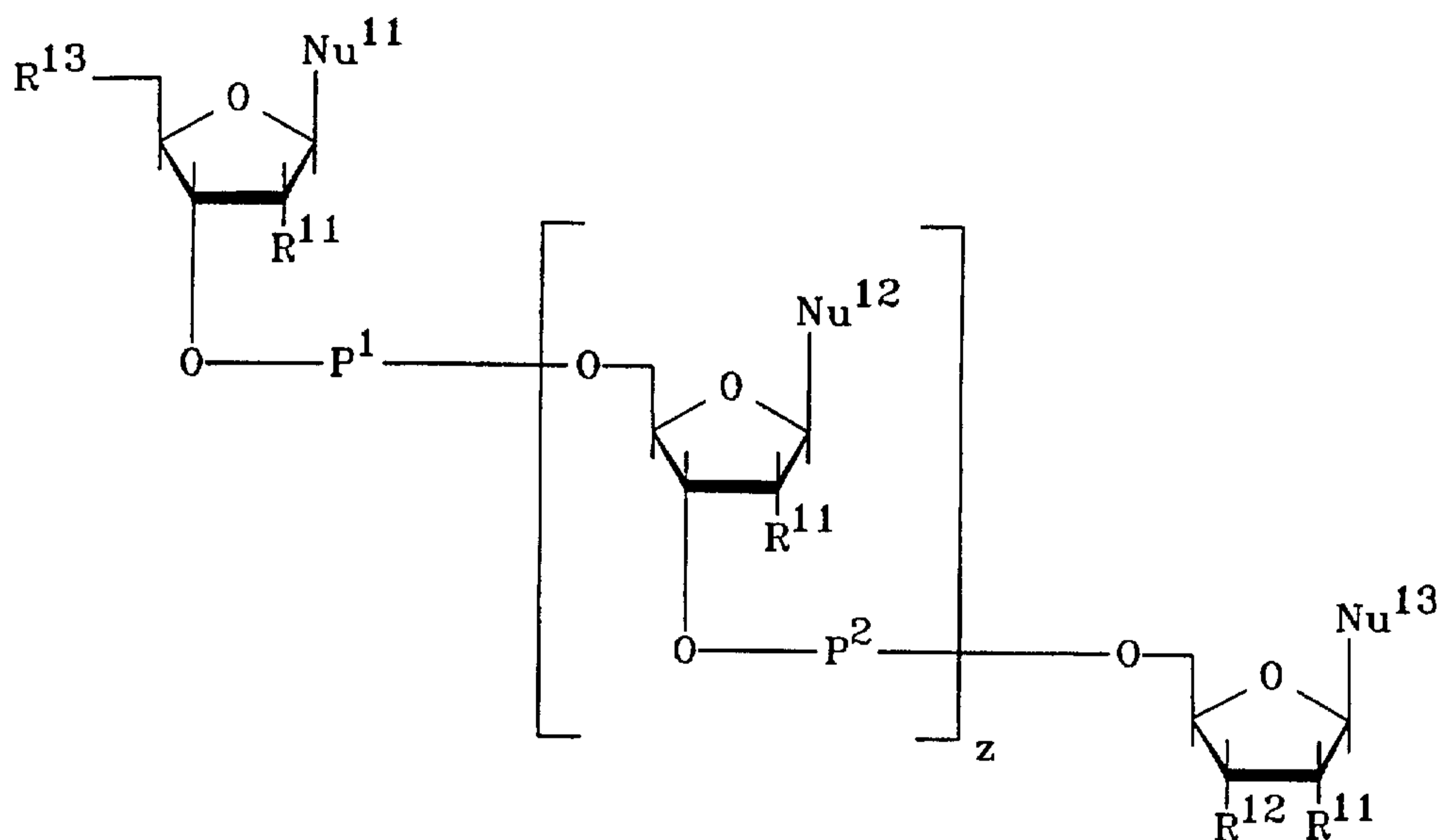

in which  $z$  is an integer of from 1 to 1000; each  $R^{11}$  is independently  $-H$  or  $-OH$ ; each  $R^{12}$  and  $R^{13}$  is independently hydroxyl, protected hydroxyl, monophosphate ester, diphosphate ester, or triphosphate ester; each  $P^1$  and  $P^2$  is independently  $-P(O)(OH)-$ ,  $-P(O)(NH_2)-$ ,  $-P(S)(OH)-$ ,  $-P(O)(CH_3)-$ , or a pharmaceutically acceptable salt thereof; each  $Nu^{11}$ ,  $Nu^{12}$  and  $Nu^{13}$  is independently

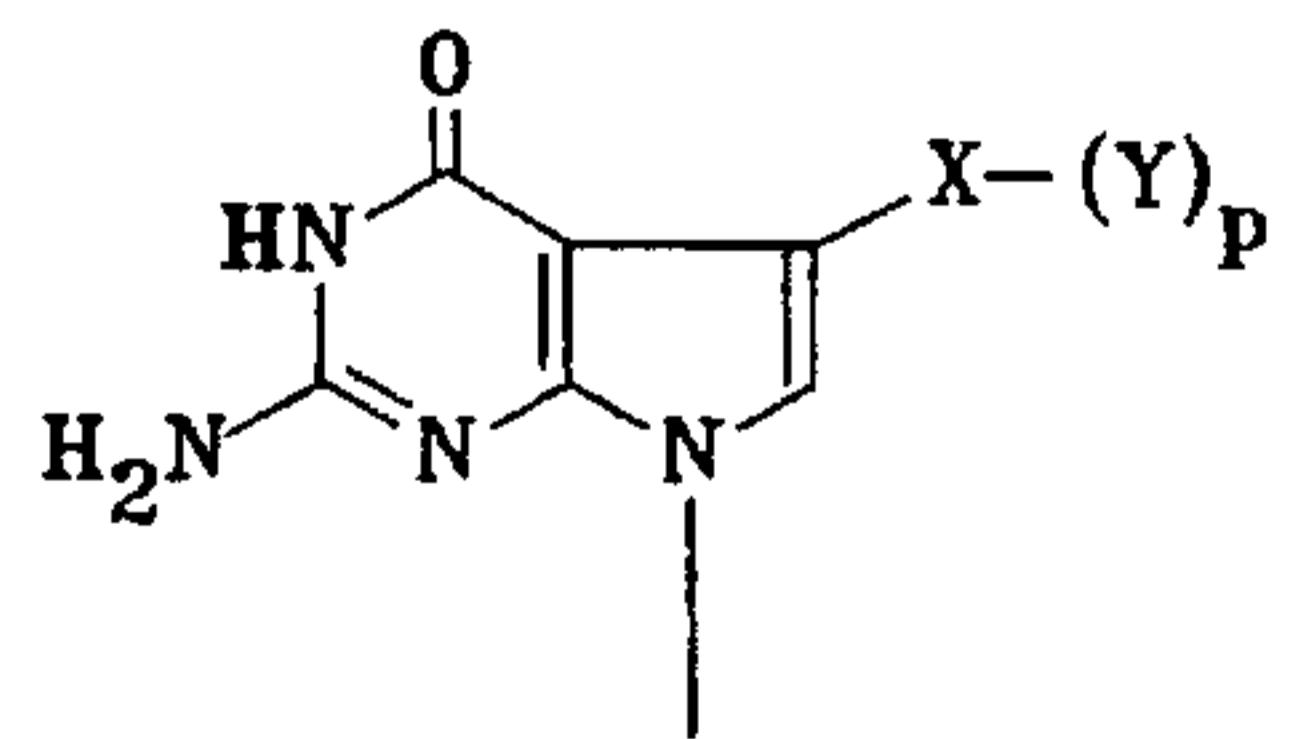
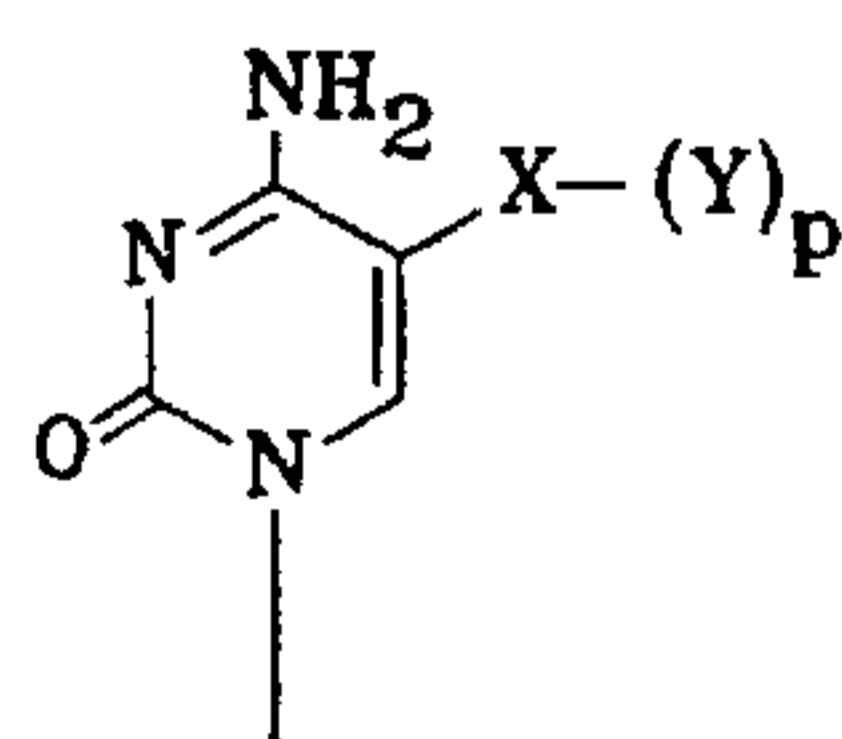
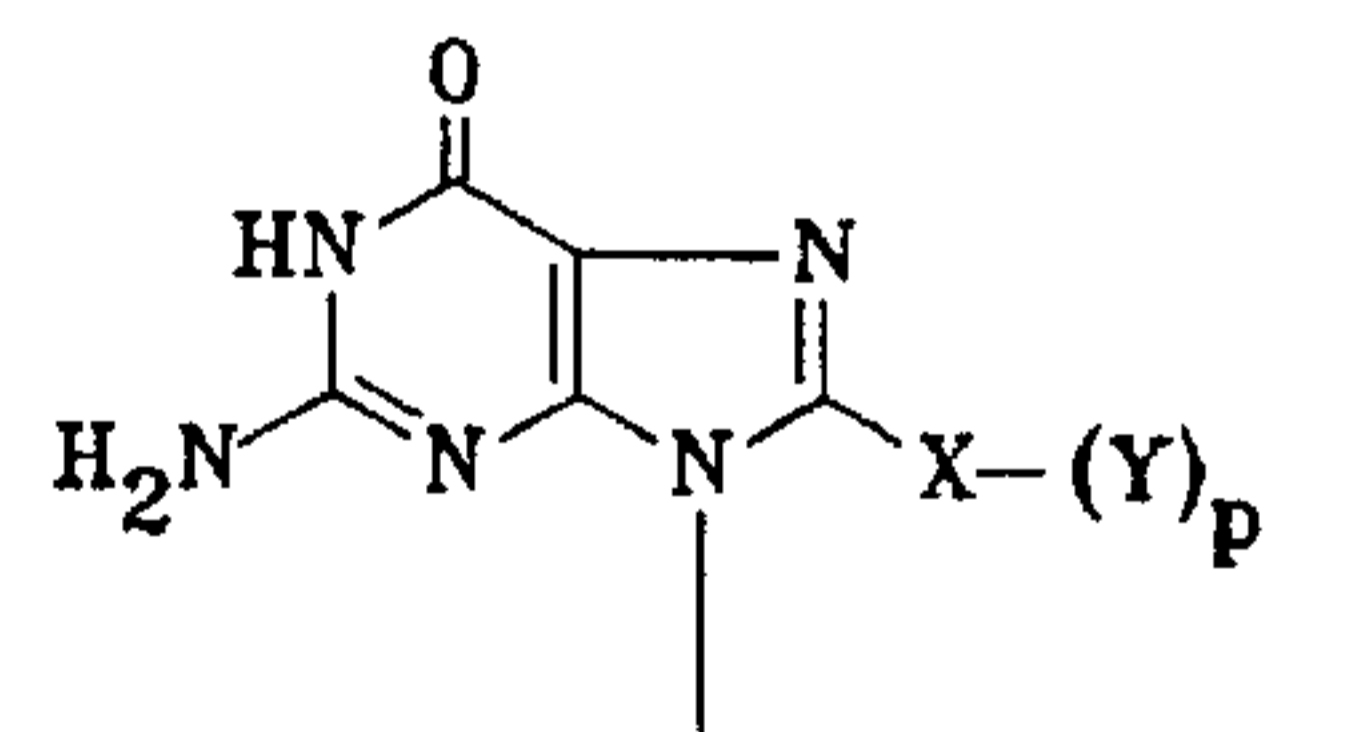
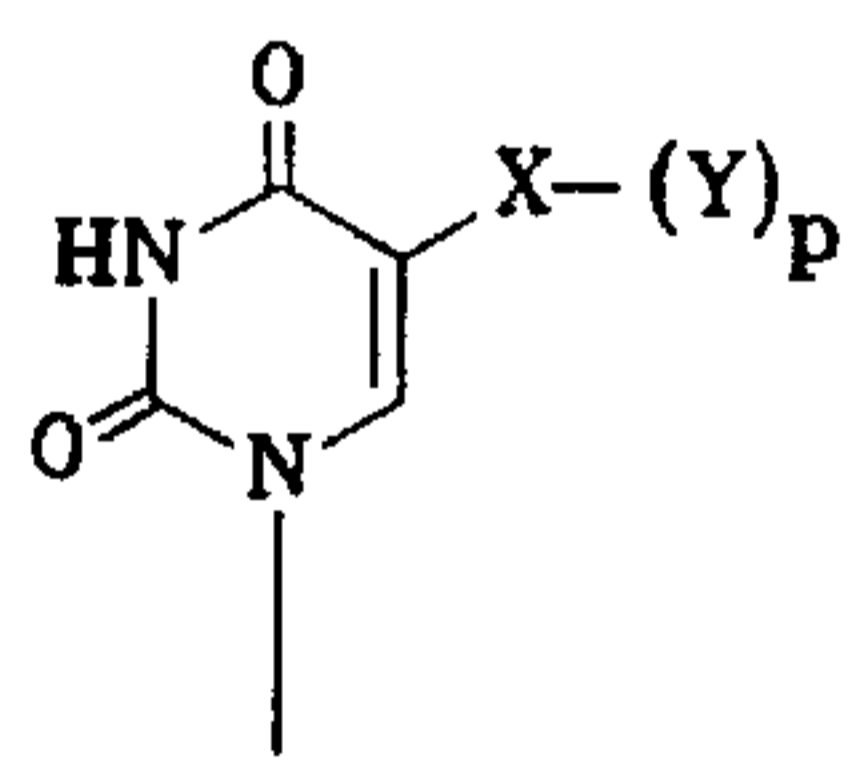
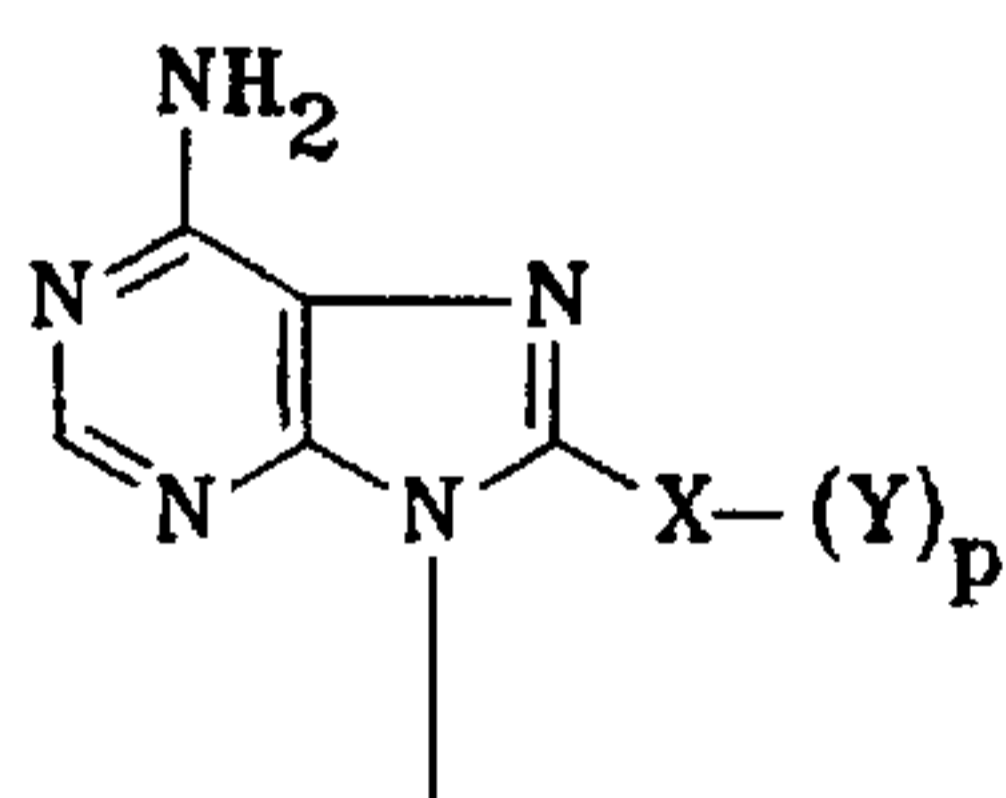

adenine, guanine, thymine or cytosine,

in which  $X$  is a linking group of from 7 to 30 carbon atoms, a portion of which is an

aromatic ring. Y is a boron-containing moiety, preferably a boronic acid or boronic ester moiety; and p is an integer of from 1 to 3. For the above polynucleotides, at least one and no more than thirty of Nu<sup>11</sup>, Nu<sup>12</sup> and Nu<sup>13</sup> are other than adenine, guanine, thymine or cytosine.

5 Still further, the present invention provides methods for the use of the modified polynucleotides and related derivatives to detect the presence of target nucleic acids in a sample.

Various embodiments of this invention provide a compound having the formula:

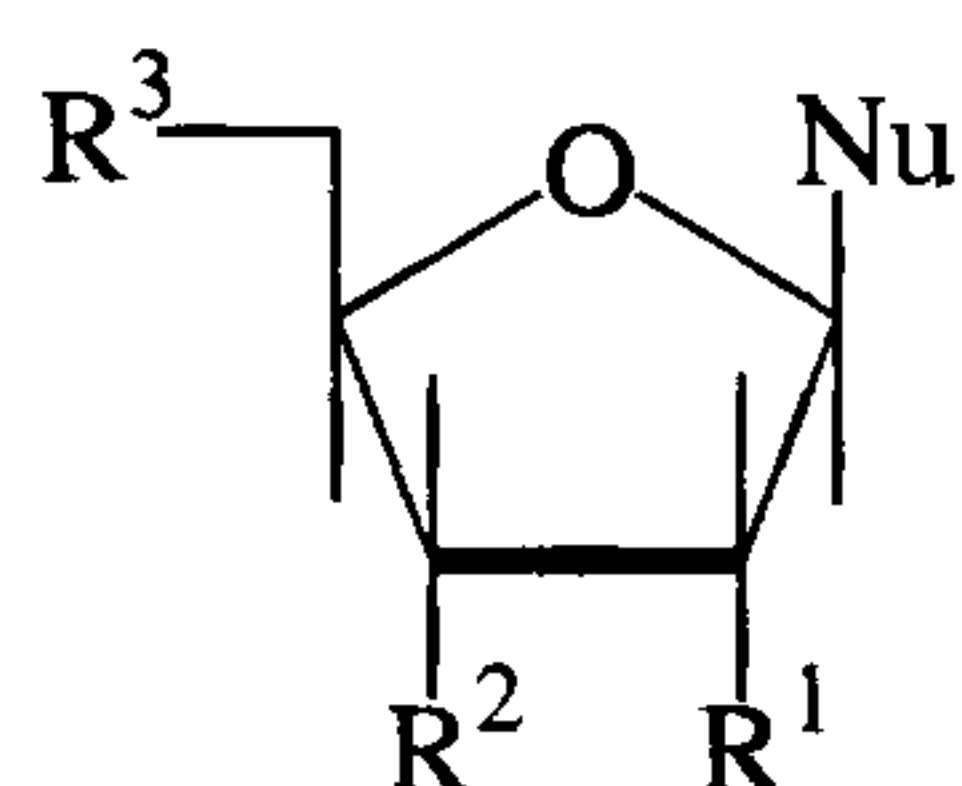

wherein R<sup>1</sup>, R<sup>2</sup> and R<sup>3</sup> are each members independently selected from the group consisting of hydrogen, hydroxyl, protected hydroxyl, monophosphate ester, diphosphate ester, and triphosphate ester; Nu is a radical selected from the group consisting of

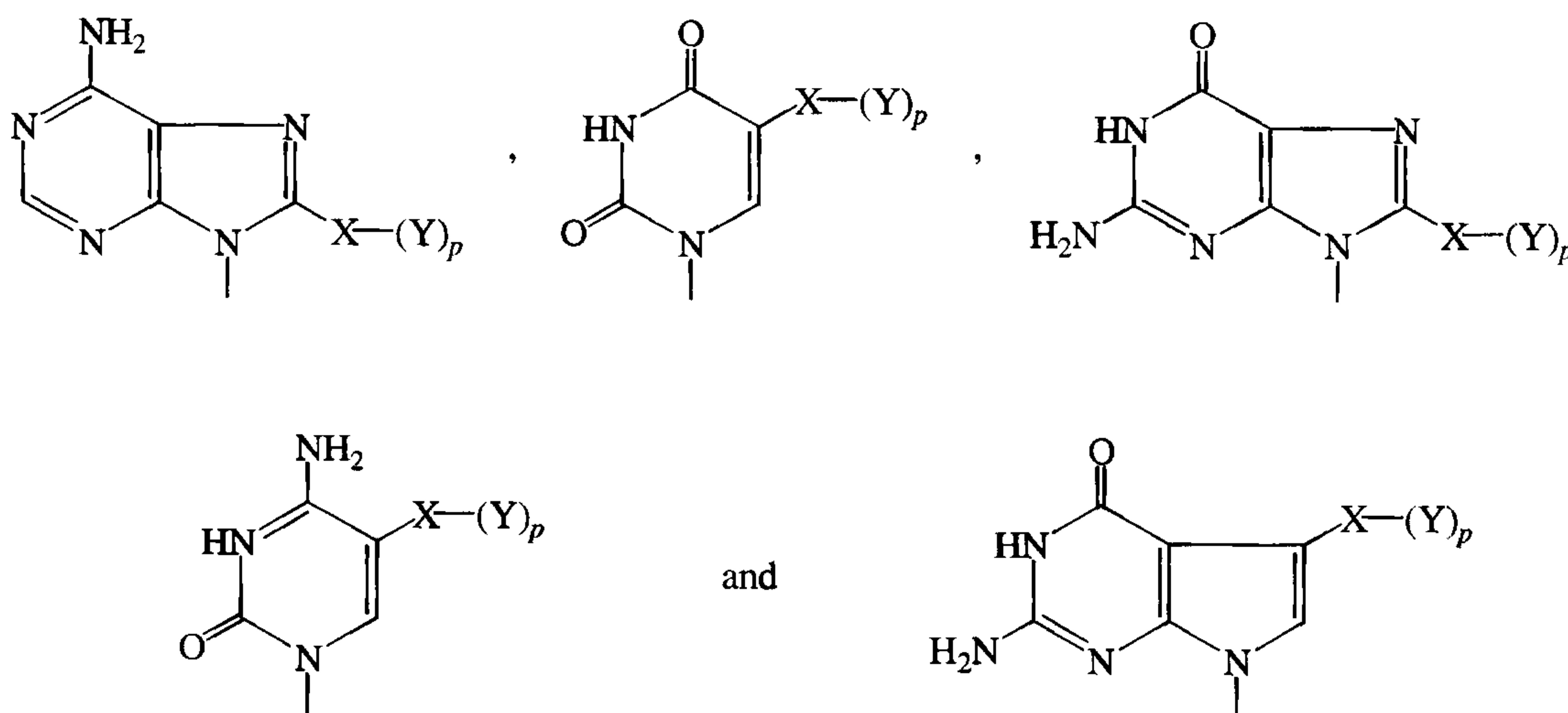

wherein: p is an integer of from 1 to 3, and -X- and -(Y)<sub>p</sub> taken together comprise a radical selected from the group consisting of

5a

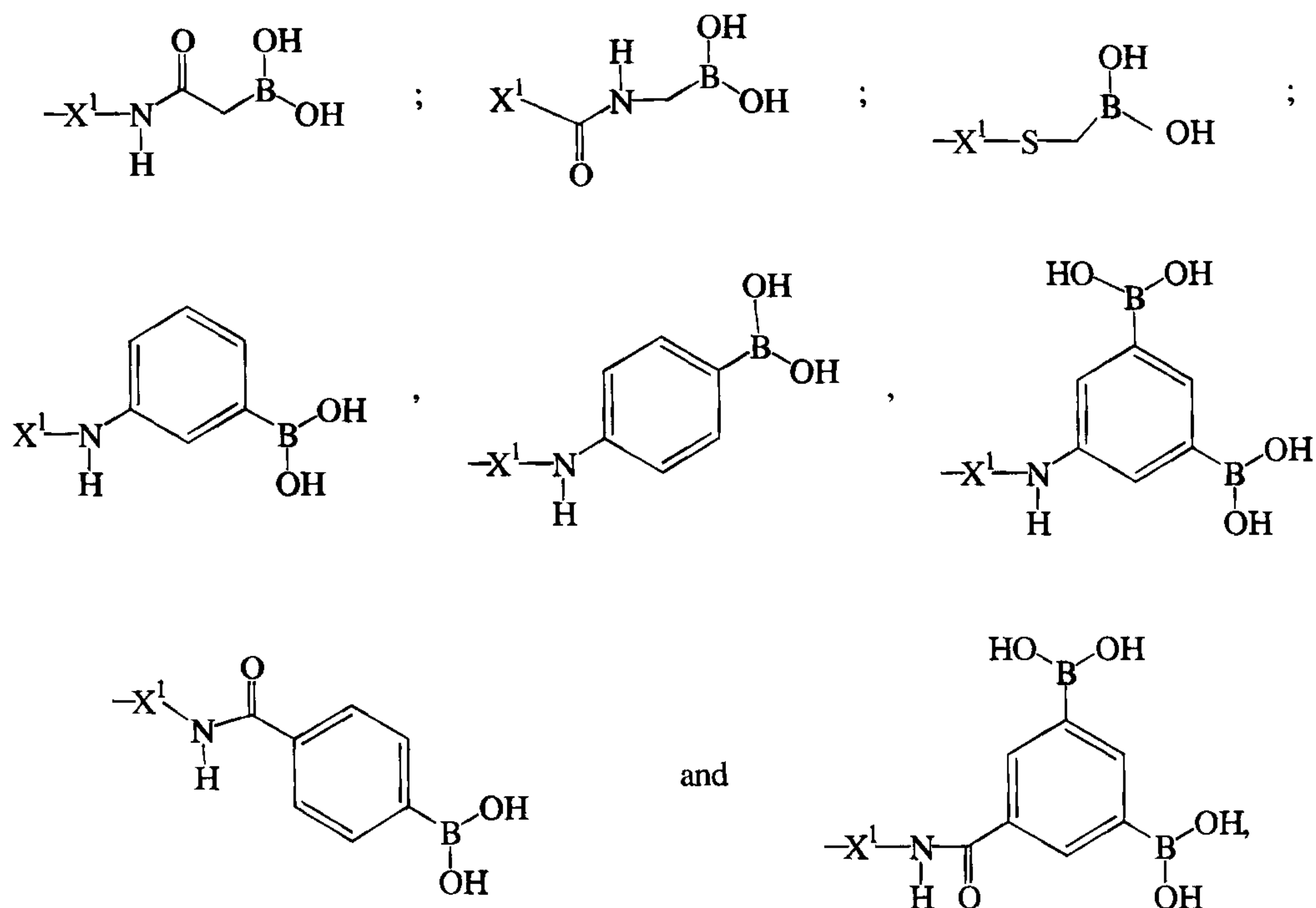

in which  $X^1$  is a linking group fragment comprising of from 3 to 23 carbon atoms.

Other embodiments of this invention provide a compound having the formula:

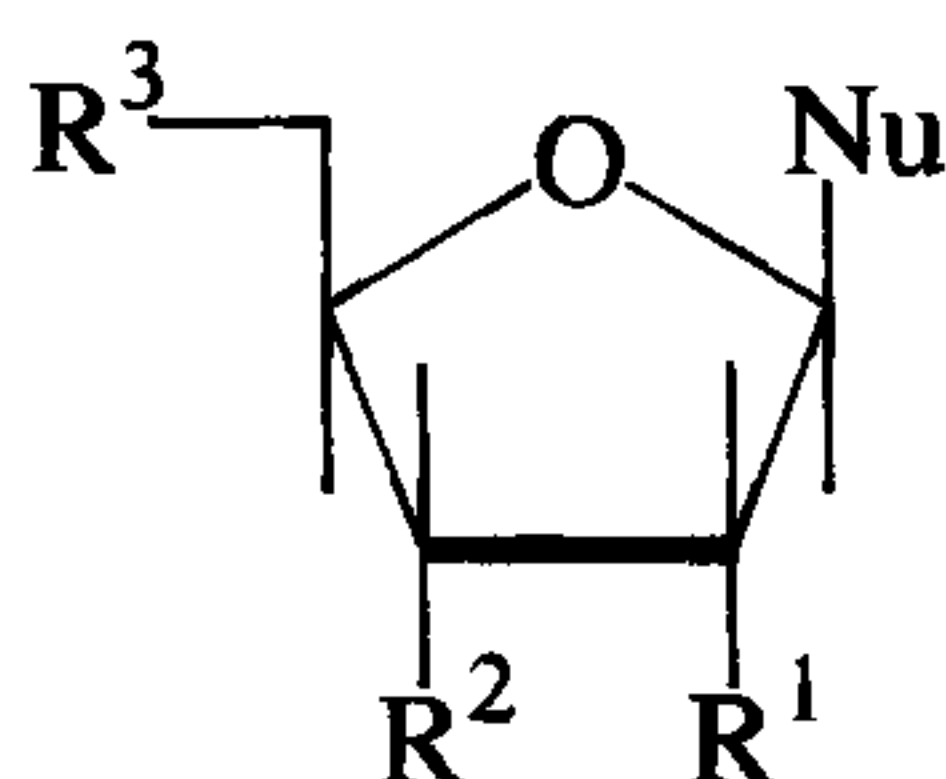

wherein  $R^1$ ,  $R^2$  and  $R^3$  are each members independently selected from the group consisting of hydrogen, hydroxyl, protected hydroxyl, monophosphate ester, diphosphate ester, and triphosphate ester;  $Nu$  is a radical selected from the group consisting of



5b

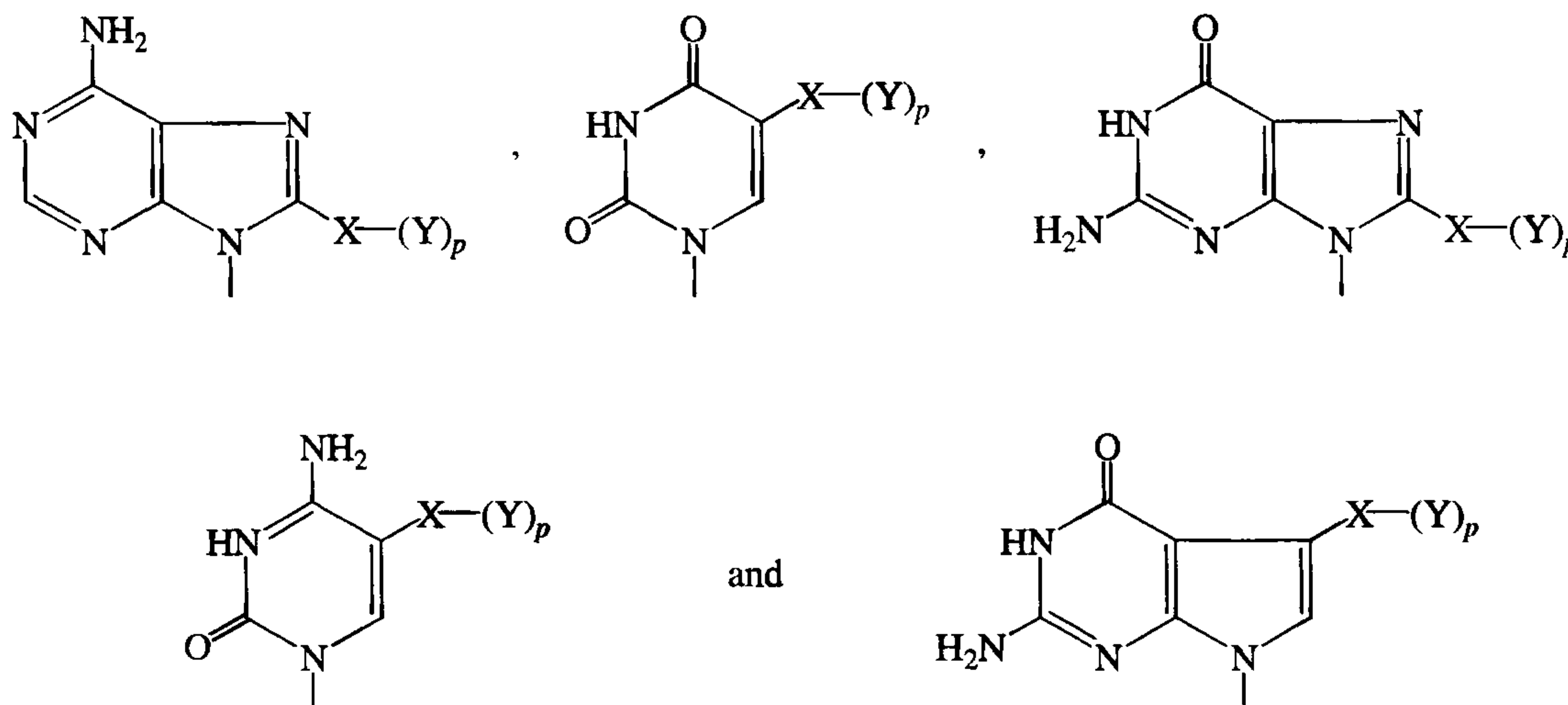

wherein: X is a linking group comprising of from 7 to 30 carbon atoms, a portion of which is an aromatic ring, and further comprising a diradical  $-CH=CH-$  attached directly to the heterocyclic portion of said Nu; and Y is a member selected from the group consisting of  $-B(OH)_2$ ,  $-B(OH)(OR)$  and  $-B(OR)(OR')$ , wherein R and R' are each independently lower alkyl groups having from one to six carbon atoms; and p is an integer of from 1 to 3.

Other embodiments of this invention provide a compound having the formula:

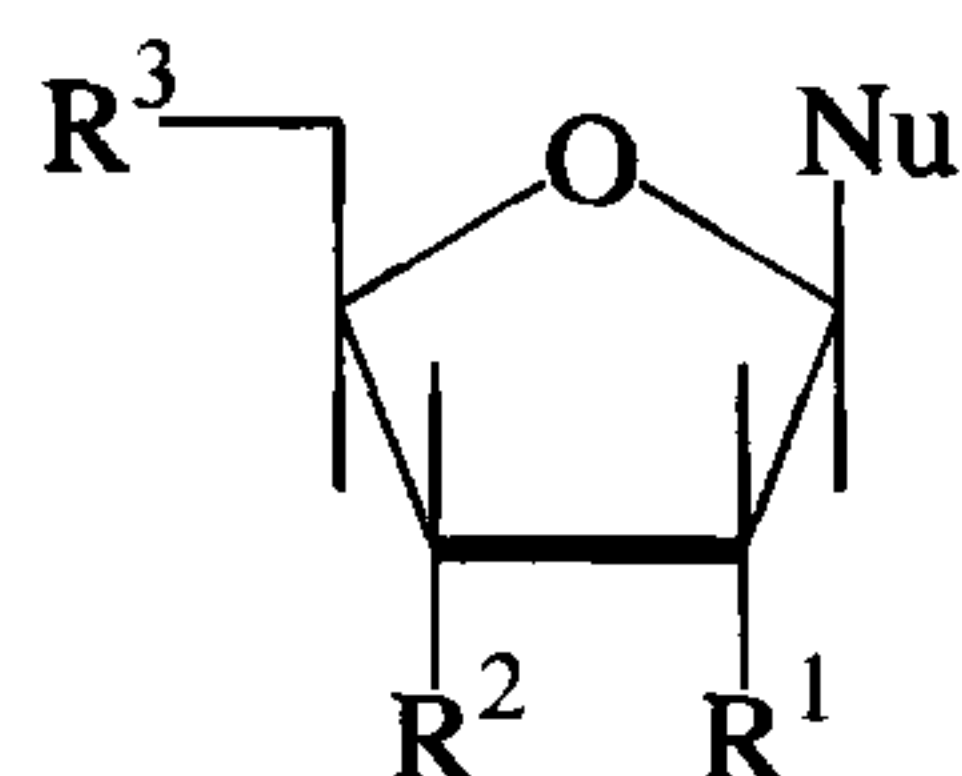

wherein:  $R^1$ ,  $R^2$  and  $R^3$  are each members independently selected from the group consisting of hydrogen, hydroxyl, protected hydroxyl, monophosphate ester, diphosphate ester, and triphosphate ester; Nu is a radical selected from the group consisting of

5c

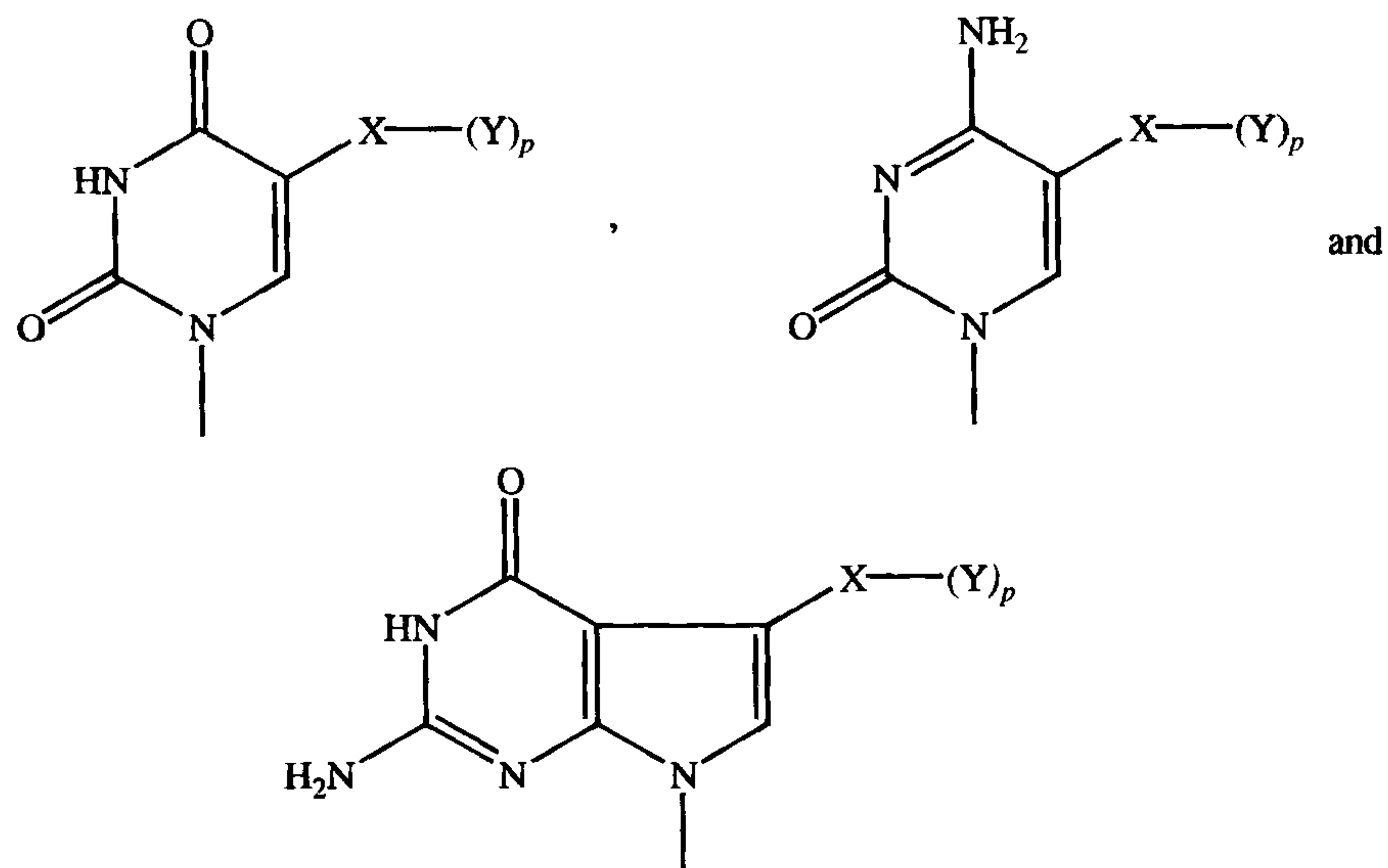

wherein: X is a linking group comprising of from 7 to 30 carbon atoms, a portion of which is an aromatic ring; and Y is a member selected from the group consisting of  $-B(OH)_2$ ,  $-B(OH)(OR)$  and  $-B(OR)(OR')$ , wherein R and R' are each independently lower alkyl groups having from one to six carbon atoms; and p is an integer of from 1 to 3.

Other embodiments of this invention provide modified polynucleotides incorporating the aforementioned compounds.

Other embodiments of this invention provide a method of detecting the presence of a target nucleic acid in a sample comprising contacting the sample with a modified polynucleotide of this invention which is substantially complementary to the target nucleic acid under conditions sufficient to hybridize the modified polynucleotide to the target nucleic acid, thereby forming a hybridized complex; contacting said hybridized complex with a boronic acid complexing agent, said agent comprising an indicator; and detecting the presence of said indicator, thereby detecting the presence of said target nucleic acid.

**BRIEF DESCRIPTION OF THE DRAWINGS**

Figure 1 illustrates the structure of PBA-XX-dUTP and also illustrates a complex which is formed with a boronic acid complexing reagent.

Figure 2 illustrates a synthesis scheme for the preparation of PBA-XX-dUTP.

5 Figure 3 illustrates alternative coupling reactions beginning with 5-aminoallyl-dUTP.

Figure 4 illustrates the use of modified polynucleotides in target polynucleotide detection.

Figure 5 illustrates the use of modified polynucleotides in affinity purification.

10 Figure 6 illustrates complexing agents (labels and boronic acid complexing moieties) and labeled complexes which can be formed.

Figures 7-17 provide reaction schemes for the preparation of complexing agents and the intermediates to which appropriate labels can be attached.

15 Figure 18 is a gel which demonstrates the incorporation of PBA-XX-dUTP into a polynucleotide using PCR.

Figure 19 is a gel which demonstrates the incorporation of PBA-XX-dUTP into a polynucleotide using random primed labeling and a PBA-labeled primer.

Figure 20 is a gel which shows the random primed labeling incorporation of PBA-XX-dUTP and capture by DHBHA-Sepharose.

20 Figure 21 is a gel which shows the terminal transferase incorporation of PBA-XX-dUTP into a 21-mer oligonucleotide.

## DETAILED DESCRIPTION OF THE INVENTION

### Abbreviations

The following abbreviations are used herein: AA, amino allyl; PBA, phenylboronic acid; SHA, salicylhydroxamic acid; DHBHA, 2,6-dihydroxybenzo-hydroxamic acid; PCR, polymerase chain reaction; NHS, N-hydroxysuccinimide; PBA-XX-dUTP, 5-(3-aminophenylboronic acid succinamido hexanoyl)-aminoallyldeoxy-uridine 5'-triphosphate; PBA-X-dUTP, 5-(3-aminophenylboronic acid succinamido)allyldeoxy-uridine 5'-triphosphate.

### Description of the Embodiments

The field of nucleic acid probes has been the subject of several recent reviews. See, NONISOTOPIC DNA PROBE TECHNIQUES, Academic Press, Chapter 1, Kricha, ed. (1992) and NONISOTOPIC PROBING, BLOTTING, AND SEQUENCING, Academic Press, Chapter 2, Kessler, ed. (1995).

The present invention provides modified nucleic acid monomers which are useful for the preparation of modified polynucleotides. These polynucleotides find application in nucleic acid detection methods described more fully below. The modified nucleic acid monomers will contain a boric or boronic acid moiety attached to the heterocyclic portion of the nucleic acid. The attachment is made via a linking group which is typically from 7 to 30 carbon atoms in length, contains an aromatic ring and is optionally interrupted by one or more amide, ester, disulfide, urea, carbamate, hydrazone, ether, thioether, amine or imine groups. As used herein, the term "aromatic ring" is meant to include both carbocyclic and heterocyclic aromatic rings such as, for example, a phenyl, naphthyl, thienyl, furanyl or pyrazolyl ring. The linking group will also be of sufficient length that the boronic acid group can form a complex with a boronic acid complexing agent when the modified nucleic acid is incorporated into an polynucleotide. The term "polynucleotide" refers to a single or double-stranded polymer of deoxyribonucleotide or ribonucleotide bases read from the 5' to the 3' end. It includes both self-replicating

plasmids, infectious polymers of DNA or RNA and non-functional DNA or RNA.

Modified polynucleotides are also provided in which the polynucleotide is constructed from naturally-occurring monomeric nucleic acids and one or more modified nucleic acid monomers of the present invention. The modified polynucleotides of the present invention will typically be from 10 to 1000 bases in length and contain from 1 to about 30 modified monomers. The number of modified monomers should not be so great as to interfere with the intended purpose of the polynucleotide.

Boronic acid and boronate ester moieties form complexes with certain polar molecules and have been exploited in a number of chromatographic methods. In these methods, a boronic acid group is immobilized on a solid support and used to selectively retain those polar molecules having the required functionality which includes 1,2-diols, 1,3-diols, 1,2-hydroxyacids, 1,3-hydroxyacids, 1,2- and 1,3-hydroxylamines, and 1,2- and 1,3-diketones. Each of these functional groups are known to form complexes with, for example, phenylboronic acid. Additionally, these functional groups are present in a number of biological molecules including carbohydrates, catecholamines, prostaglandins, ribonucleosides and steroids. The use of boronic acid chromatographic media for the isolation and separation of biological molecules has been reviewed. See, Singhal, *et al.*, *Adv. Chromatog.* **31**:293-335 (1992); Mazzeo, *et al.*, *BioChromatog.* **4**:124-130 (1989); and Bergold, *et al.*, in SOLID PHASE BIOCHEMISTRY, Scouten, ed., John Wiley & Sons, New York, pp. 149-187 (1983).

Boric or boronic acids are Lewis acids and ionize by hydration in which the trigonal acid is converted to a tetrahedral boronate anion. Similarly, when complexes are formed with a boronic acid, the boron adopts a tetrahedral configuration in which the average bonds lengths to the boron atom are about 10% longer. More importantly, complexes are formed in a pH dependent manner in many instances. See, Lorand, *et al.*, *J. Org. Chem.* **24**:769 (1959), Sienkiewicz, *et al.*, *J. Inorg. Nucl. Chem.*, **42**:1559-1571 (1980) and Tanner, *et al.*, *J. Am. Chem. Soc.* **89**:6954 (1967). This property provides additional advantages for the use of boronic acids in the monomers, polynucleotides and methods described below.

### Boron-Containing Monomers

In one aspect, the present invention provides modified nucleic acids having the formula:

8

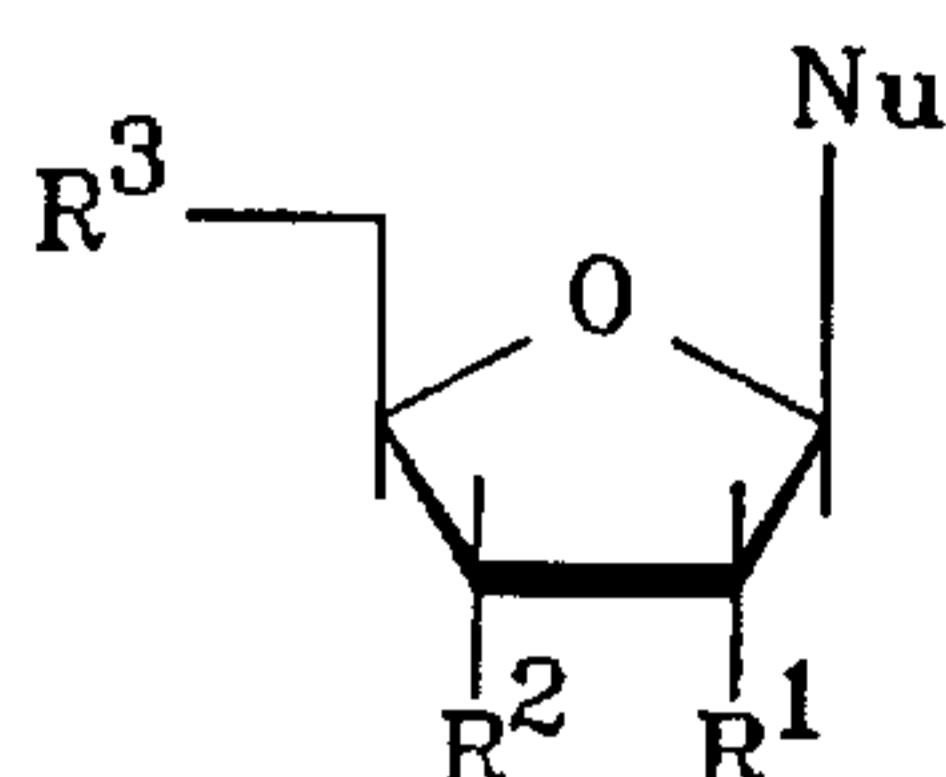

In this formula,  $R^1$ ,  $R^2$  and  $R^3$  are each independently hydrogen, hydroxyl, protected hydroxyl, monophosphate ester, diphosphate ester, or triphosphate ester. In preferred embodiments,  $R^1$  is hydrogen, hydroxyl or protected hydroxyl;  $R^2$  is hydroxyl, protected hydroxyl, or monophosphate ester; and  $R^3$  is hydroxyl, protected hydroxyl, monophosphate ester, diphosphate ester, or triphosphate ester. The symbol Nu represents a radical which is:

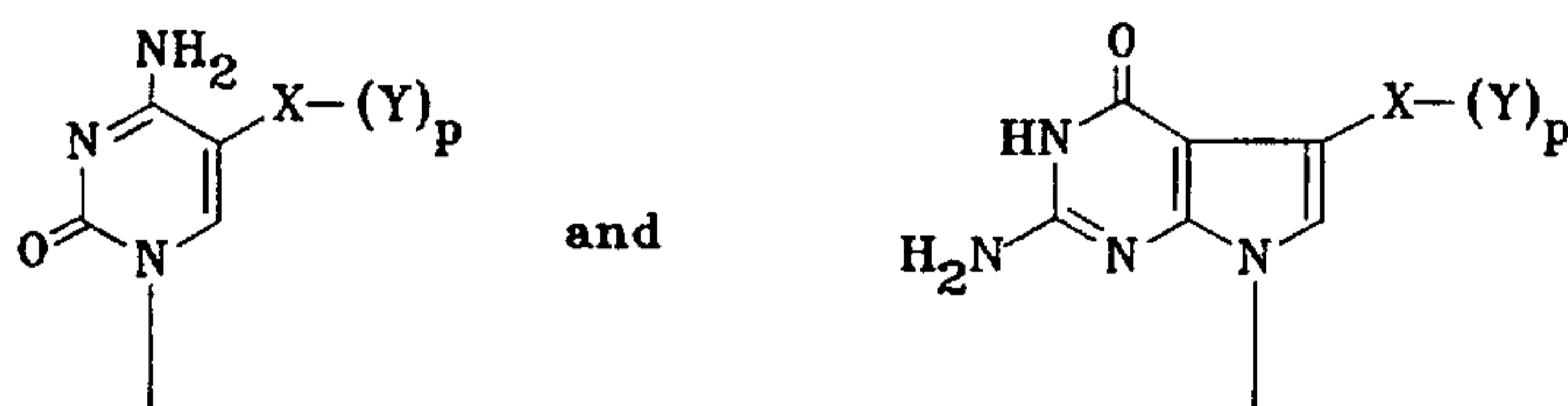
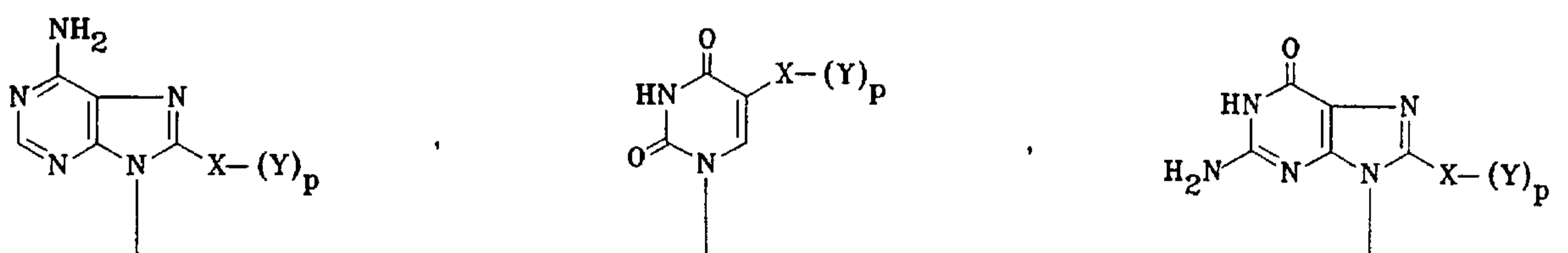

in which the letter X represents a linking group of from 7 to 30 carbon atoms, at least a portion of which is an aromatic ring. The linking group is optionally interrupted by one or more amide, ester, disulfide, urea, carbamate, hydrazone, ether, thioether, amine or imine groups. The letter Y represents a boron-containing moiety which is typically a boronic acid, a borinic acid, or a boronic acid ester. Examples of such groups are  $-\text{B}(\text{OH})_2$ ,  $-\text{B}(\text{OH})(\text{OR})$  and  $-\text{B}(\text{OR})(\text{OR}')$  in which R and R' are alkyl groups of from 1 to 6 carbon atoms which, in some embodiments, can be linked together to form a cyclic ester. The letter p represents an integer of from 1 to 3.

The linking groups used in this aspect of the invention will typically comprise of from 7 to 30 carbon atoms. In preferred embodiments, the linking group is an alkylene chain which is interrupted by one or more amide, ether, thioether, disulfide, ester, thioester, urea and amine linkages and terminates in an aromatic ring. Examples of such linkages

include  $-\text{CH}=\text{CH}-\text{CH}_2-\text{NHCOAr}-$ ,  $-\text{CH}=\text{CH}-\text{CH}_2-\text{NHAr}-$ ,  $-\text{CH}=\text{CH}-\text{CH}_2-\text{O}-\text{Ar}-$ ,  $-\text{CH}=\text{CH}-\text{CONH}-\text{Ar}-$ ,  $-\text{CH}=\text{CH}-\text{CH}_2-\text{CONH}-\text{Ar}-$ ,  $-\text{CH}=\text{CH}-\text{CH}_2-\text{NHCO}-(\text{CH}_2)_n-\text{NHCO}-\text{Ar}-$ , and  $-\text{CH}=\text{CH}-\text{CH}_2-\text{NHCO}-(\text{CH}_2)_n-\text{NHCO}-(\text{CH}_2)_m-\text{CONH}-\text{Ar}-$  in which Ar represents a divalent aromatic ring which is phenyl or naphthyl and n and m independently represent integers of from 1 to 6. More preferably, X is

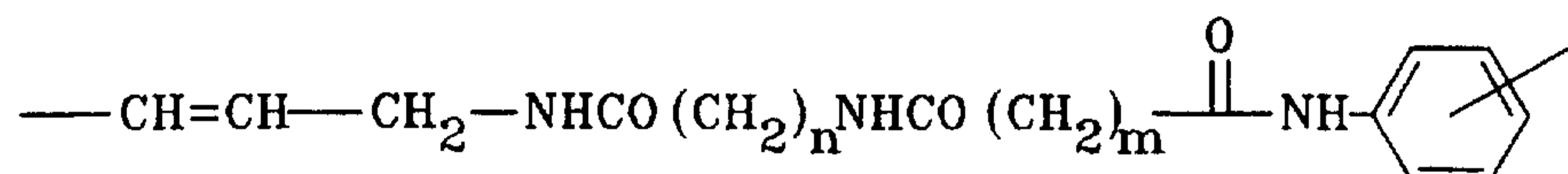

and n and m independently represent integers of from 1 to 6. One of skill in the art will understand that while the above preferred linkages all contain a site of unsaturation adjacent to the nucleic acid portion of the monomer, the invention is not so limited. The requirements for X are more simply that X does not interfere with duplex formation when the monomers are incorporated into polynucleotides and that X provide sufficient clearance for the boronic acid or ester moiety (Y) to engage in binding of complexing agents without affecting duplex stability for polynucleotides containing the above monomers.

In one group of embodiments, -X- and -(Y)<sub>p</sub> are taken together and comprise a radical which is

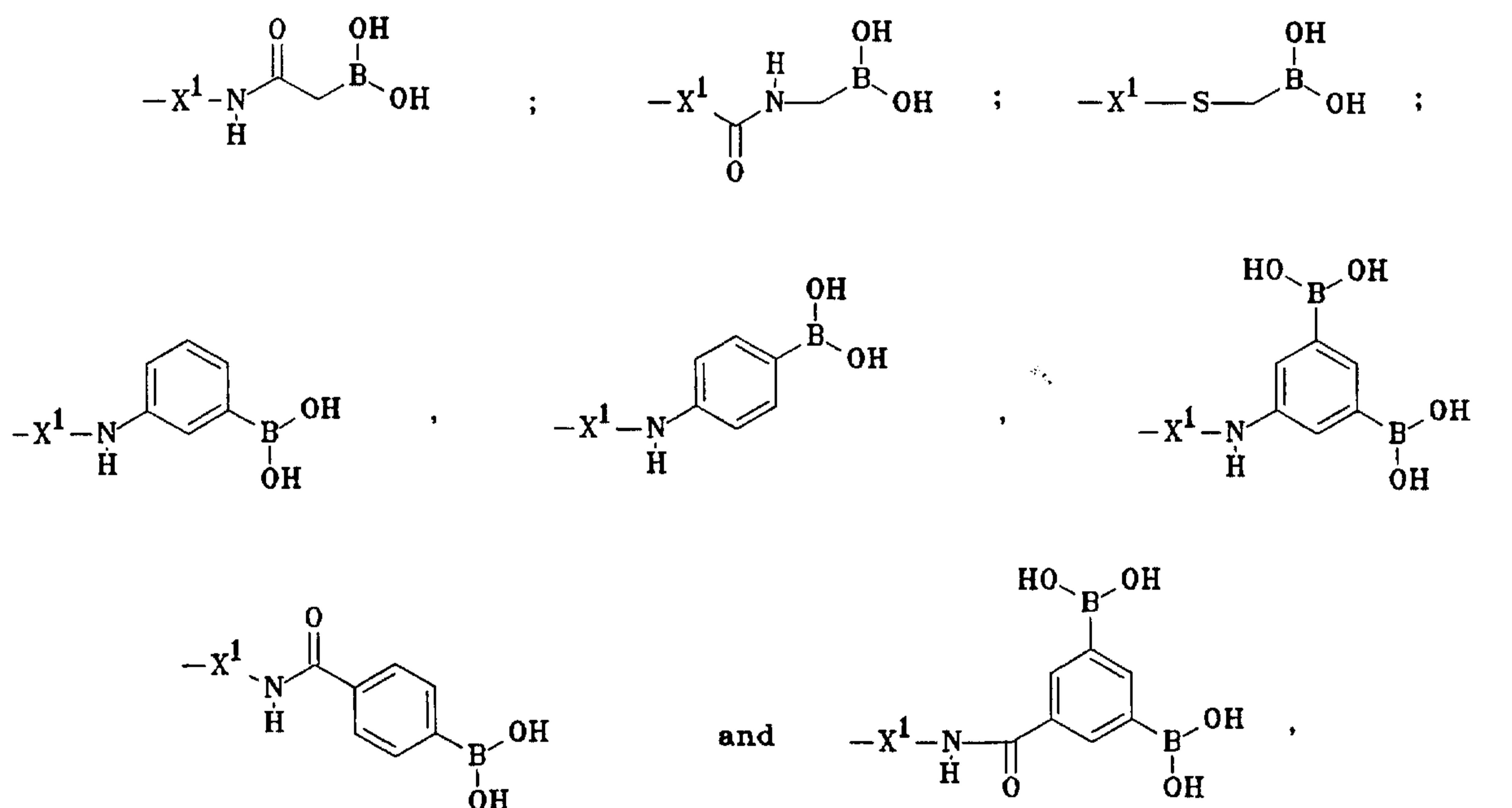

in which X<sup>1</sup> is a linking group fragment having from 3 to 23 carbon atoms. In preferred embodiments, the linking group fragment is —CH=CH—(CH<sub>2</sub>)<sub>n</sub>-NHCO—, —CH=CH—(CH<sub>2</sub>)<sub>m</sub>-, —CH=CH—(CH<sub>2</sub>)<sub>m</sub>-O—, —CH=CH—CONH—, —CH=CH—(CH<sub>2</sub>)<sub>n</sub>-CO—, —CH=CH—CH<sub>2</sub>-NHCO—(CH<sub>2</sub>)<sub>n</sub>-NHCO—, and  
 5 —CH=CH—CH<sub>2</sub>-NHCO—(CH<sub>2</sub>)<sub>n</sub>-NHCO—(CH<sub>2</sub>)<sub>m</sub>-CO— in which n and m independently represent integers of from 1 to 6.

The monomers in this aspect of the present invention can be prepared by a number of methods. For the preparation of modified pyrimidine bases (*e.g.* modified uridines and cytidines), a synthetic scheme is preferred which begins with the preparation of  
 10 5-aminoallyl-dUTP (see, Langer, *et al.*, *Proc. Natl. Acad. Sci. USA*, **78**:6633-6637 (1981)).

Briefly, deoxyuridine 5'-triphosphate is first chloromercurated at the 5-position using mercuric chloride, then treated with allylamine in the presence of potassium tetrachloropalladate to effect a carbon-carbon bond formation and provide 5-aminoallyl-dUTP. Alternatively, the same procedures can be employed with, for  
 15 example, deoxyuridine, deoxyuridine 5'-monophosphate, deoxyuridine 5'-diphosphate, uridine 5'-triphosphate, uridine 5'-diphosphate, uridine 5'-monophosphate, uridine, and the corresponding cytidine compounds.

In other embodiments, the modified nucleic acids can be prepared beginning with 5-hydroxymethyl-2'-deoxycytidine monophosphate (prepared by enzymatic hydrolysis  
 20 of non-glycosylated phage T<sub>4</sub>DNA as described in U.S. Patent No. 5,241,060),

5-(4-aminobutylaminomethyl)-2'-deoxyuridinemonophosphate (see U.S. Patent No. 5,241,060), 5-formyl-2'-deoxyuridine (see, Mertes, *et al.*, *J. Heterocyclic Chem.* **1**:751 (1970)), and 5-(oxy)acetic acid-2'-deoxyuridine (see, Deschamps, *et al.*, *J. Med. Chem.* **21**:228 (1978)).

25 Following the addition of a functional group at the 5-position, the linker can be extended and a suitable boronic acid group can be appended. Alternatively, a more convergent approach can be taken in which the desired boronic acid or boronic acid-containing moiety is attached to a portion of the linking group and the resulting combination is then attached to the 5-aminoallyl-dUTP. Figure 2 provides a synthetic scheme for the  
 30 preparation of PBA-XX-dUTP. In this scheme, 3-aminophenylboronic acid is treated with methyl succinyl chloride to provide the amide 2a. Subsequent saponification of the ester and coupling of the activating group N-hydroxysuccinimide (NHS) provides the activated ester



2b. Treatment of 2b with 6-aminohexanoic acid provides 2c which can be coupled with 5-aminoallyl-dUTP to provide the monomer depicted in Figure 1 (abbreviated as PBA-XX-dUTP).

Alternatively, modified nucleic acids can be prepared using synthetic methods described in Hashimoto, *et al.*, *J. Org. Chem.* 58:4194-4195 (1993) and Hashimoto, *et al.*, *J. Am. Chem. Soc.* 115:7128-7134 (1993). Briefly,

modified uridine and cytidine analogs are synthesized beginning with the corresponding 5-iodo-2'-deoxyuridine and 5-iodo-2'-deoxycytidine. Reaction of the iodo-nucleosides with an appropriately protected amino alkyne in the presence of a palladium catalyst provides the desired carbon framework for further elaboration. Hydrogenation of the newly introduced alkyne can be accomplished over a palladium on carbon catalyst to provide analogs having a protected amine which is linked to the nucleotide via a saturated carbon tether. In other embodiments the alkyne may be kept as part of the linking group or may be reduced to an alkene using controlled hydrogenation over palladium on carbon catalysts. The remaining steps for elongation of the linking group and attachment of a boronic acid moiety will follow those steps described above.

One of skill in the art will understand that similar synthetic methodologies can be used which begin with other boronic acid-containing species, for example, (4-carboxyphenyl)boronic acid, (3-isothiocyanatophenyl)boronic acid, (3-iodoacetamidophenyl)boronic acid, (5-carboxy-3-isothiocyanatophenyl)boronic acid and (3-maleimidophenyl)boronic acid. These compounds are either commercially available or can be prepared by methods described in Linder, *et al.*, *Bioconjugate Chem.* 2:160-170 (1991) or Linder, *et al.*, *Bioconjugate Chem.* 2:407-415 (1991).

Examples of suitable derivatization and coupling to 5-aminoallyl-dUTP are provided in Figure 3. The general synthetic methods provided in Figures 2 and 3 all utilize 5-aminoallyl-dUTP as the acceptor for the boronic acid-containing group. However, one of skill in the art will appreciate that other suitably substituted nucleic acids could be used as well (*e.g.*, the commercially available N6-(aminohexyl)-dATP).

Preparation of modified purine nucleotides and deazapurine nucleotides can also be carried out as described above for pyrimidine nucleosides. Mercuration of the C8 position of the purine ring and the C7 position of a deazapurine has been described. See, Dale, *et al.*, *Proc. Natl. Acad. Sci. USA* 70:2238 (1973) and Dale, *et al.*, *Biochemistry*

14:2447 (1975).

Following

mercuration of the nucleosides, allyl amine can be coupled to the heterocyclic ring using the procedures outlined above. Further synthesis to provide the monomers of the present invention are then be carried out, also as described above.

5

### Boron-Containing Polynucleotides

In another aspect, the present invention provides modified polynucleotides having the formula:

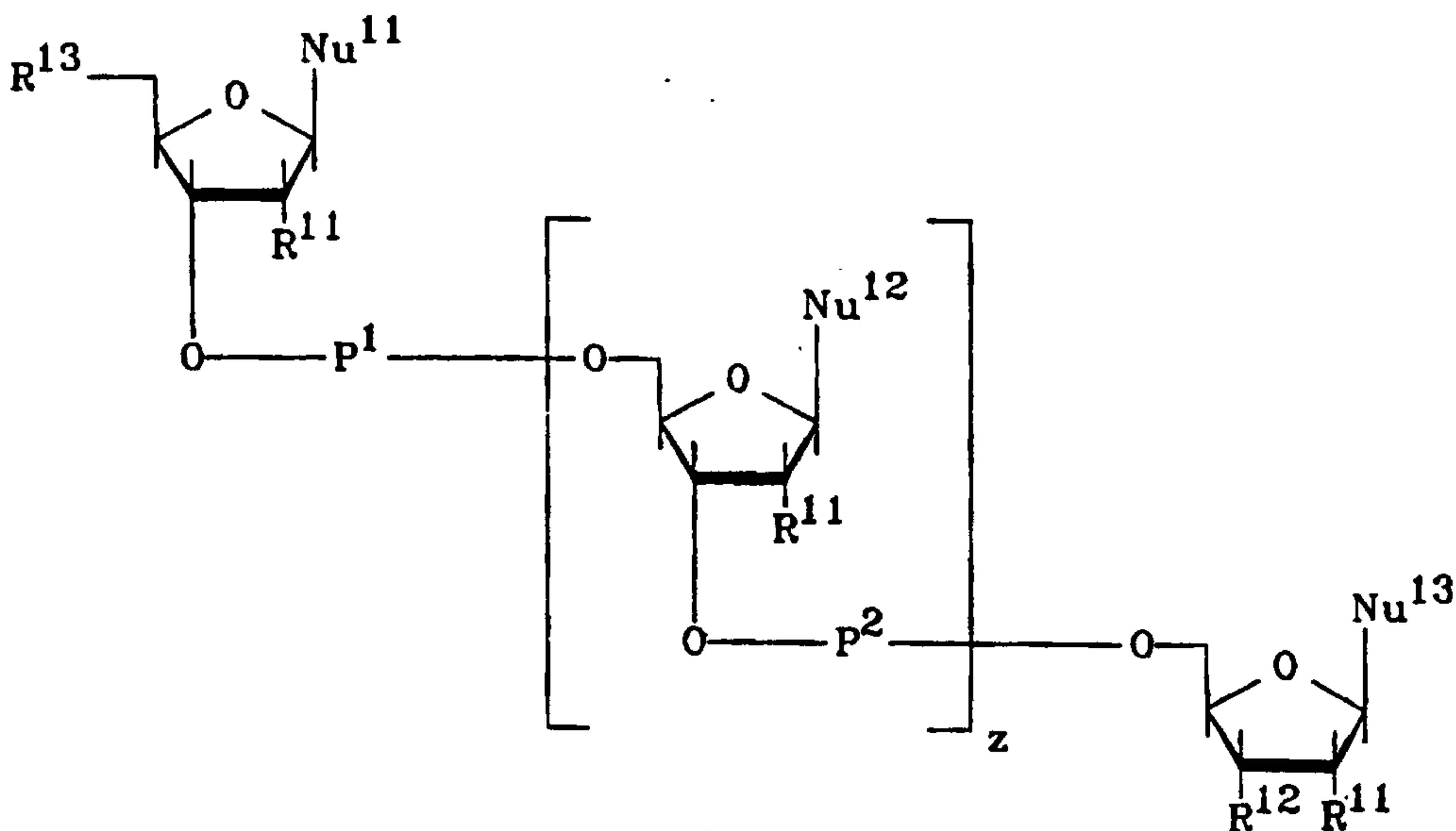

10

In this formula,  $z$  represents an integer of from 1 to 1000 and each  $R^{11}$  is  $-H$  or  $-OH$ . The symbols  $R^{12}$  and  $R^{13}$  each independently represent a hydroxyl, protected hydroxyl, monophosphate ester, diphosphate ester, or triphosphate ester. The symbols  $P^1$  and  $P^2$  are each independently  $-P(O)(OH)-$ ,  $-P(O)(NH_2)-$ ,  $-P(S)(OH)-$ ,  $-P(O)(CH_3)-$ , or a pharmaceutically acceptable salt thereof.

15

In the above formula, each  $Nu^{11}$ ,  $Nu^{12}$  and  $Nu^{13}$  is independently adenine, guanine, thymine, cytosine or a modified nucleic acid base having the formula:

13

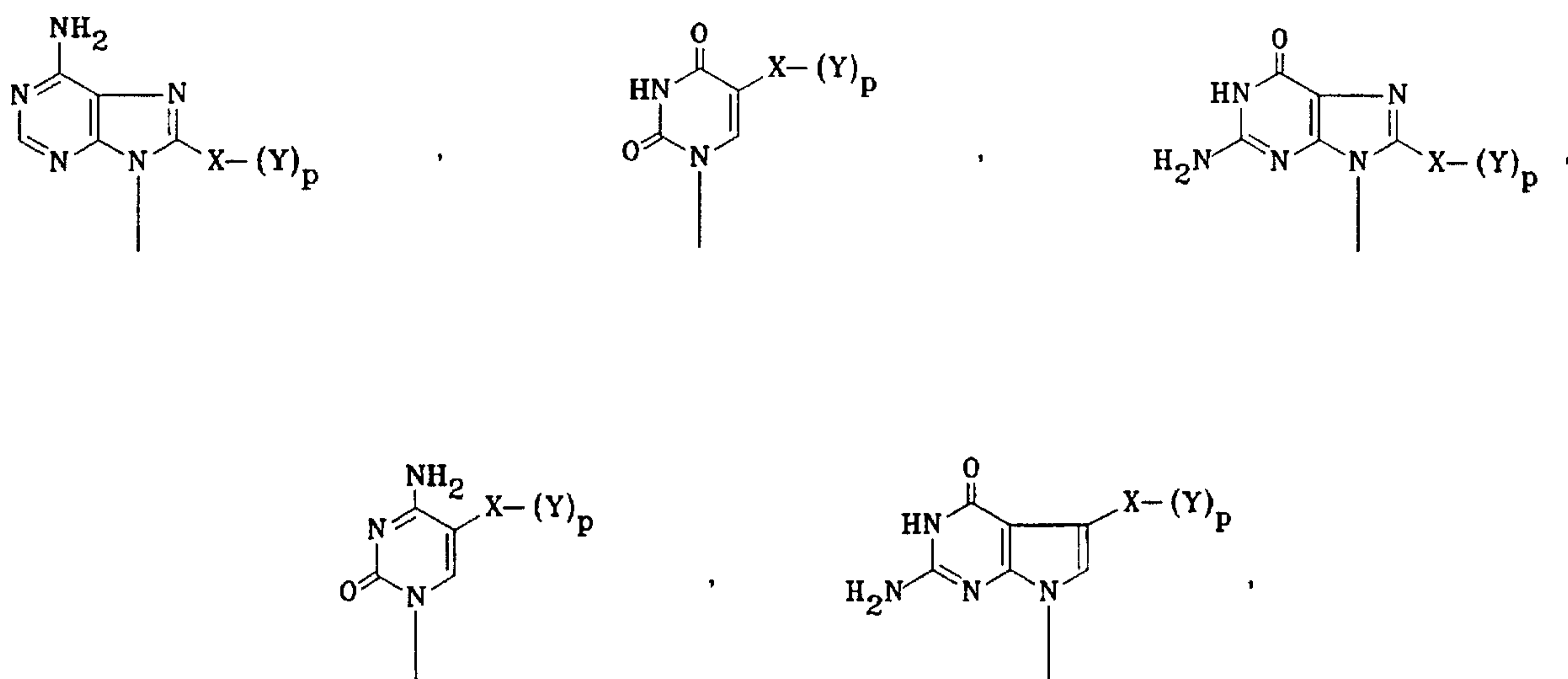

The nucleic acid derivatives above, are modified to have a boron-containing moiety which is attached to the heterocyclic ring portion by means of a linking group X. Typically, the linking group comprises of from 7 to 30 carbon atoms, a portion of which is present as an aromatic ring. Preferred groups for X are those which have been described above for the monomers of the present invention. The boron-containing moiety, Y, is a boronic acid substituent such as  $\text{—B(OH)}_2$ ,  $\text{—B(OH)(OR)}$  and  $\text{—B(OR)(OR')}$  in which R and R' are alkyl groups of from 1 to 6 carbon atoms which, in some embodiments, can be linked together to form a cyclic ester. As used herein, the term "alkyl" refers to a saturated hydrocarbon radical which may be straight-chain or branched-chain (for example, ethyl, isopropyl, *t*-amyl, or 2-methylpentyl). Preferred groups for Y are also those which have been described above for the monomers. The modified polynucleosides and polynucleotides of the present invention are constructed such that at least one and no more than thirty of Nu<sup>11</sup>, Nu<sup>12</sup> and Nu<sup>13</sup> are other than adenine, guanine, thymine or cytosine. One of skill in the art will understand that the number of modified nucleic acid monomers in an polynucleotide will depend in part on the particular application (*e.g.*, the sensitivity of the complexing agent which is ultimately attached to the boronic acid moiety in various assays). Additionally, the modified monomers should not be so numerous as to interfere with the intended purpose of the modified polynucleotide (*e.g.*, binding or duplex formation with a target gene or target polynucleotide). Thus, for example, an polymer of 20 to 30 monomers will typically contain from one to five modified monomers, while an polymer of 1000 monomers can contain up to about 30 modified monomers.

## Preparation of Boron-Containing Polynucleotides

The boron-containing polynucleotides used in the present invention may be synthesized in solid phase or in solution, using the above boron-containing monomers and other nucleoside bases. In some embodiments, the boron-containing polynucleotides are prepared using enzyme-based methodology such as PCR, random prime labeling, tailing or nick translation.

Alternatively, polynucleotide synthesis can be carried out using commercially available monomers such as, for example, N<sup>6</sup>-(6-aminohexyl)-dATP. After the polynucleotide has been prepared, one or more boronic acid-containing moieties can be attached to the pendent amino group using methods described above and in the examples which follow.

### Solid phase synthesis

Detailed descriptions of the procedures for solid phase synthesis of polynucleotides by phosphite-triester, phosphotriester, and H-phosphonate chemistries are widely available. See, for example, Itakura, U.S. Pat. No. 4,401,796; Caruthers, *et al.*, U.S. Pat. Nos. 4,458,066 and 4,500,707; Beaucage, *et al.*, *Tetrahedron Lett.*, **22**:1859-1862 (1981); Matteucci, *et al.*, *J. Am. Chem. Soc.*, **103**:3185-3191 (1981); Caruthers, *et al.*, *Genetic Engineering*, **4**:1-17 (1982); Jones, chapter 2, Atkinson, *et al.*, chapter 3, and Sproat, *et al.*, chapter 4, in *Oligonucleotide Synthesis: A Practical Approach*, Gait (ed.), IRL Press, Washington D.C. (1984); Froehler, *et al.*, *Tetrahedron Lett.*, **27**:469-472 (1986); Froehler, *et al.*, *Nucleic Acids Res.*, **14**:5399-5407 (1986); Sinha, *et al.* *Tetrahedron Lett.*, **24**:5843-5846 (1983); and Sinha, *et al.*, *Nucl. Acids Res.*, **12**:4539-4557 (1984).

Generally, the timing of delivery and concentration of monomeric nucleotides utilized in a coupling cycle will not differ from the protocols typical for commercial phosphoramidites used in commercial DNA synthesizers. In these cases, one may merely add the solution containing the monomers to a receptacle on a port provided for an extra phosphoramidite on a commercial synthesizer (*e.g.*, model 380B, Applied Biosystems, Foster City, California, U.S.A.). However, where the coupling efficiency of a particular monomer is substantially lower than the other phosphoramidites, it may be necessary to alter the timing

of delivery or the concentration of the reagent in order to optimize the synthesis. Means of optimizing polynucleotide synthesis protocols to correct for low coupling efficiencies are well known to those of skill in the art. Generally one merely increases the concentration of the reagent or the amount of the reagent delivered to achieve a higher coupling efficiency. Methods of determining coupling efficiency are also well known. For example, where the 5'-hydroxyl protecting group is dimethoxytrityl (DMT), coupling efficiency may be determined by measuring the DMT cation concentration during the acidic removal of the DMT group. DMT cation concentration is usually determined by spectrophotometrically monitoring the acid wash. The acid/DMT solution is a bright orange color. Alternatively, since capping prevents further extension of an polynucleotide where coupling has failed, coupling efficiency may be estimated by comparing the ratio of truncated to full length polynucleotides utilizing, for example, capillary electrophoresis or HPLC.

Solid phase polynucleotide synthesis may be performed using a number of solid supports. A suitable support is one which provides a functional group for the attachment of a protected monomer which will become the 3' terminal base in the synthesized polynucleotide. The support must be inert to the reagents utilized in the particular synthesis chemistry. Suitable supports are well known to those of skill in the art. Solid support materials include, but are not limited to polyacryloylmorpholide, silica, controlled pore glass (CPG), polystyrene, polystyrene/latex, and carboxyl-functionalized teflon. Preferred supports are amino-functionalized controlled pore glass and carboxylfunctionalized teflon.

Solid phase polynucleotide synthesis requires, as a starting point, a fully protected monomer (*e.g.*, a protected nucleoside) coupled to the solid support. This coupling is typically through the 3'-hydroxyl. Typically, a linker group is covalently bound to the 3'-hydroxyl on one end and covalently bound to the solid support on the other end. The first synthesis cycle then couples a nucleotide monomer, via its 3'-phosphate, to the 5'-hydroxyl of the bound nucleoside through a condensation reaction that forms a 3'-5' phosphodiester linkage. Subsequent synthesis cycles add nucleotide monomers to the 5'-hydroxyl of the last bound nucleotide. In this manner an polynucleotide is synthesized in a 3' to 5' direction producing a "growing" polynucleotide with its 3' terminus attached to the solid support.

Numerous means of linking nucleoside monomers to a solid support are known to those of skill in the art, although monomers covalently linked through a succinate or hemisuccinate to controlled pore glass are generally preferred. Conventional protected

nucleosides coupled through a hemisuccinate to controlled pore glass are commercially available from a number of sources (*e.g.*, Glen Research, Sterling, Vermont, U.S.A.; Applied Biosystems, Foster City, California, U.S.A.; and Pharmacia LKB, Piscataway, New Jersey, U.S.A.).

5           Once the full length polynucleotide is synthesized, the polynucleotide is deprotected and cleaved from the solid support prior to use. Cleavage and deprotection may occur simultaneously or sequentially in any order. The two procedures may be interspersed so that some protecting groups are removed from the polynucleotide before it is cleaved off the solid support and other groups are deprotected from the cleaved polynucleotide in  
10 solution. The sequence of events depends on the particular blocking groups present, the particular linkage to a solid support, and the preferences of the individuals performing the synthesis. Where deprotection precedes cleavage, the protecting groups may be washed away from the polynucleotide which remains bound on the solid support. Conversely, where deprotection follows cleavage, the removed protecting groups will remain in solution with  
15 the polynucleotide. Often the polynucleotide will require isolation from these protecting groups prior to use.

In a preferred embodiment, and most commercial DNA syntheses, the protecting group on the 5'-hydroxyl is removed at the last stage of synthesis. The polynucleotide is then cleaved off the solid support, and the remaining deprotection occurs  
20 in solution. Removal of the 5'-hydroxyl protecting group typically requires treatment with the same reagent utilized throughout the synthesis to remove the terminal 5'-hydroxyl protecting groups prior to coupling the next nucleotide monomer. Where the 5'-hydroxyl protecting group is a dimethoxytrityl group, deprotection can be accomplished by treatment with acetic acid, dichloroacetic acid, trichloroacetic acid or trifluoroacetic acid.

25           Where the polynucleotide is a ribonucleotide and the 2'-hydroxyl group is blocked with a tert-butyldimethylsilyl (TBDMS) moiety, the latter group may be removed using tetrabutylammonium fluoride in tetrahydrofuran at the end of synthesis. See Wu, *et al.*, *J. Org. Chem.* 55:4717-4724 (1990). Phenoxyacetyl protecting groups can be removed with anhydrous ammonia in alcohol (under these conditions the TBDMS groups are stable  
30 and the polynucleotide is not cleaved). The benzoyl protecting group of cytidine is also removed with anhydrous ammonia in alcohol.

Cleaved and fully deprotected polynucleotides may be used directly (after lyophilization or evaporation to remove the deprotection reagent) or they may be purified prior to use. Purification of synthetic polynucleotides is generally desired to isolate the full length polynucleotide from the protecting groups that were removed in the deprotection step and, more importantly, from the truncated polynucleotides that were formed when polynucleotides that failed to couple with the next nucleotide monomer were capped during synthesis.

Polynucleotide purification techniques are well known to those of skill in the art. Methods include, but are not limited to, thin layer chromatography (TLC) on silica plates, gel electrophoresis, size fractionation (*e.g.*, using a Sephadex column), reverse phase high performance liquid chromatography (HPLC) and anion exchange chromatography (*e.g.*, using the mono-Q column, Pharmacia-LKB, Piscataway, New Jersey, U.S.A.). For a discussion of polynucleotide purification see McLaughlin, *et al.*, chapter 5, and Wu, *et al.*, chapter 6 in *Oligonucleotide Synthesis: A Practical Approach*, Gait (ed.), IRL Press, Washington, D.C., (1984).

### Enzyme-Based Methodology

The synthesis of modified polynucleotides containing a modified monomer described above can also be achieved by enzyme-based methods as detailed in the examples set forth below. Pyrimidine, purine and deazapurine nucleoside triphosphates containing a boronic acid moiety linked to the heterocyclic ring can be used as substrates for a wide variety of purified nucleic acid polymerases of both prokaryotic and eukaryotic origin. These include Taq DNA polymerase, DNA polymerase I of *E. coli*, bacteriophage T4 DNA polymerase, DNA polymerases alpha and beta from murine (A-9) and human (HeLa) cells, and the DNA polymerase of Herpes simplex virus. Nick-translation, random prime labeling, and terminal transferase tailing are also useful methods for the incorporation of a modified nucleic acid monomer into an polynucleotide. Nick-translation can be carried out as described in Rigby, *et al.*, *J. Mol. Biol.* 113:237-251 (1977).

Random prime labeling can be conducted utilizing a modification of the method of Feinberg, *et al.*, *Anal. Biochem.* 132:6-13 (1988) in which a modified monomer is used in place of dTTP. Incorporation can be verified by capture of the probe (or modified polynucleotide) on DHBHA-Sepharose. Tailing, or terminal transfer can be carried out using

the method of Abhay, *et al.*, *Anal. Biochem.* **169**:376-382 (1988) in which a modified (boronic acid-containing) monomer is diluted into dTTP. As above, incorporation of the modified monomer can be verified by capture of the probe on DHBHA-Sepharose.

### Methods of Using Boron-Containing Polynucleotides

5           The boron-containing polynucleotides of the present invention have application in numerous diagnostic methods. Figure 4 illustrates one applications for the use of the modified polynucleotides in a DNA probe detection system. In Figure 4a, a modified polynucleotide is prepared using random-primed DNA labeling and PBA-XX-dUTP as the boron-containing monomer. One of skill in the art will understand that any of the monomers described above could also be used, as well as alternative methods of polymer formation (e.g., nick translation, solid phase synthesis, and terminal transferase). Following preparation of the PBA-labeled probe, a blot hybridization can be carried out in which the labeled probe is applied to filter-bound DNA (Figure 4b), under conditions in which hybridization takes place between the probe and a target polynucleotide. The presence of a target polynucleotide can then be determined using, for example, enzyme-linked detection. As shown in Figure 4c, alkaline phosphatase-linked to a boronic acid complexing moiety such as salicylhydroxamic acid (SHA, represented in Figure 4c as a diamond shape), will complex to the boronic acid portion of the probe (represented by the "Y" in Figures 4a-c). Subsequent treatment with a substrate for alkaline phosphatase which forms a detectable product (S → P, in Figure 4c) provides a means by which the presence of the target nucleic acid or polynucleotide can be detected.

          Alternatively, the modified polynucleotides of the present invention can be used for affinity purification of a target polynucleotide, which is illustrated in Figure 5. In this aspect of the invention, the probes are prepared as described and added to a mixture of polynucleotides containing a target polynucleotide. Following hybridization, magentic beads having an attached boronic acid complexing moiety are placed in the mixture and binding to the PBA-labeled probe occurs. The beads (with attached probe and target) are drawn to a magnetic plate and the remaining materials are washed away.

          Still further, the modified polynucleotides can be used in combination with other purification and labeling methods to provide unique methods of isolating and detecting



picogram quantities of target polynucleotides (see Examples below).

Accordingly, the present invention provides methods for detecting the presence of a target nucleic acid in a sample, comprising;

- 5 (a) contacting a sample with a modified polynucleotide which is substantially complementary to the target nucleic acid under conditions sufficient to hybridize the modified polynucleotide to the target nucleic acid thereby forming a hybridized complex;
- (b) contacting the hybridized complex with a complexing agent which comprises a detectable moiety or an indicator and a boronic acid complexing moiety; and
- 10 (c) detecting the presence of the detectable moiety or indicator, thereby detecting the presence of the target nucleic acid.

The modified polynucleotides used in this aspect of the invention are represented by the formula:

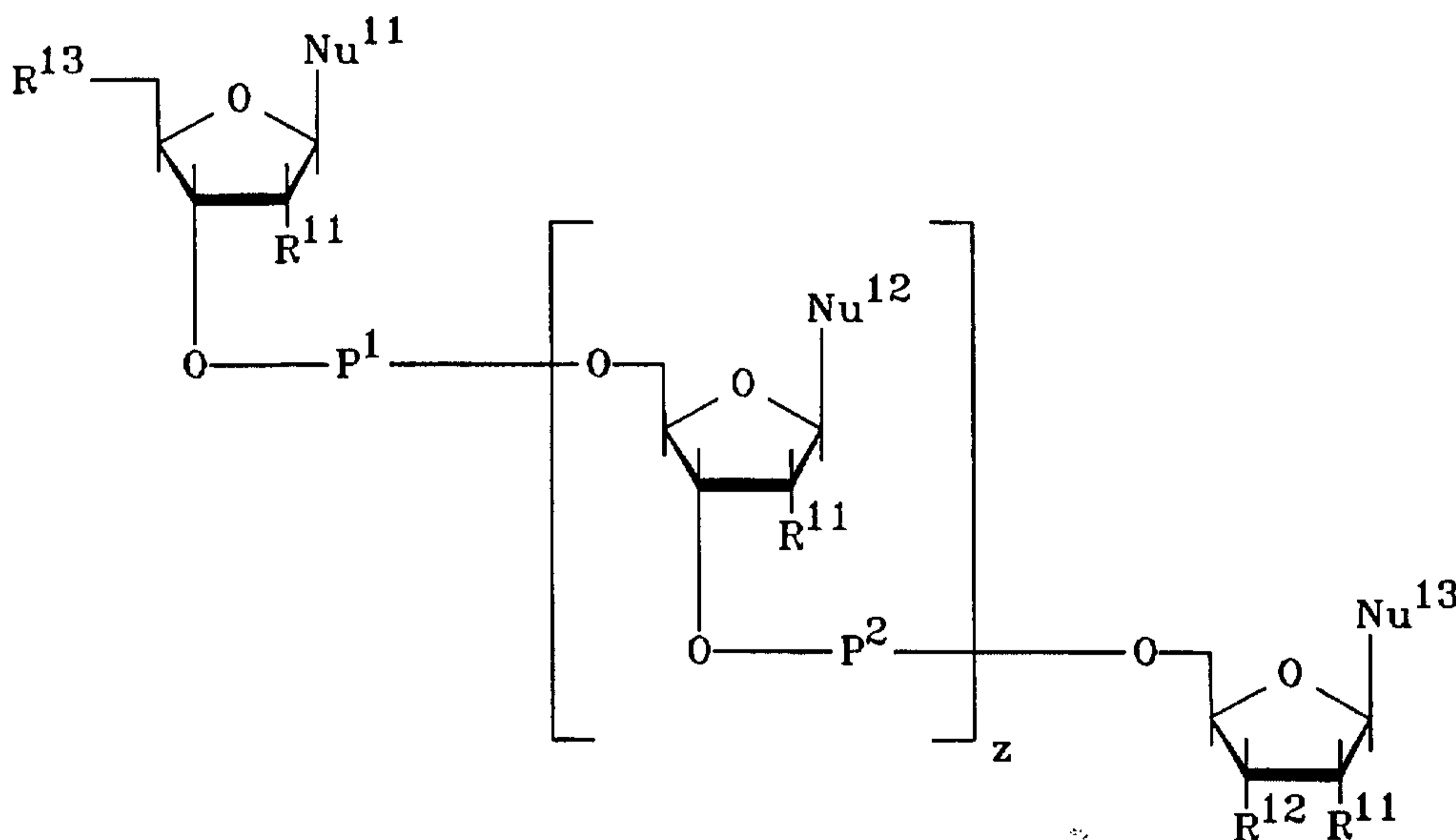

- 15 In this formula,  $z$  represents an integer of from 1 to 1000 and each  $R^{11}$  is  $-H$  or  $-OH$ . The symbols  $R^{12}$  and  $R^{13}$  each independently represent a hydroxyl, protected hydroxyl, monophosphate ester, diphosphate ester, or triphosphate ester. The symbols  $P^1$  and  $P^2$  are each independently  $-P(O)(OH)-$ ,  $-P(O)(NH_2)-$ ,  $-P(S)(OH)-$ ,  $-P(O)(CH_3)-$ , or a pharmaceutically acceptable salt thereof.

- 20 In the above formula, each  $Nu^{11}$ ,  $Nu^{12}$  and  $Nu^{13}$  is independently adenine, guanine, thymine, cytosine or a modified nucleic acid base having the formula:

20

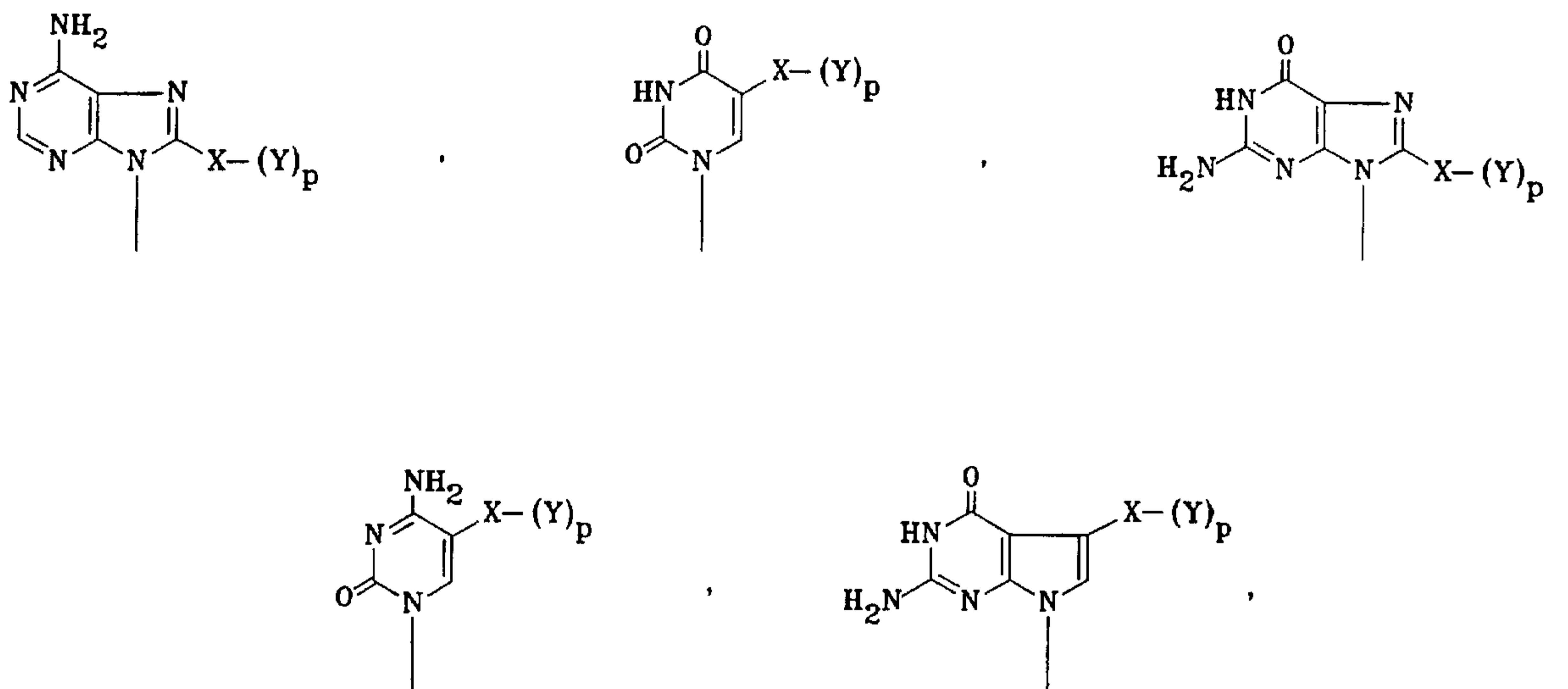

The nucleic acid derivatives above, are modified to have a boron-containing moiety which is attached to the heterocyclic ring portion by means of a linking group X. Typically, the linking group comprises of from 3 to 30 carbon atoms. Preferred groups for X are those which have been described above for the monomers of the present invention. The boron-containing moiety, Y, is a boronic acid substituent such as  $-\text{B}(\text{OH})_2$ ,  $-\text{B}(\text{OH})(\text{OR})$  and  $-\text{B}(\text{OR})(\text{OR}')$  in which R and R' are alkyl groups of from 1 to 6 carbon atoms which, in some embodiments, can be linked together to form a cyclic ester. The letter p represents an integer of from 1 to 3. Preferred groups for Y are also those which have been described above for the monomers.

The modified polynucleosides and polynucleotides of the present invention are constructed such that at least one and no more than thirty of  $\text{Nu}^{11}$ ,  $\text{Nu}^{12}$  and  $\text{Nu}^{13}$  are other than adenine, guanine, thymine or cytosine. One of skill in the art will understand that the number of modified nucleic acid monomers in a polynucleotide will depend in part on the particular application (*e.g.*, the sensitivity of the complexing agent which is ultimately attached to the boronic acid moiety in various assays). Additionally, the modified monomers should not be so numerous as to interfere with the duplex formation which takes place between the modified polynucleotide and the target polynucleotide (*e.g.*, a target gene or target oligonucleotide). Thus, for example, an oligomer of 20 to 30 monomers will typically contain from one to five modified monomers, while a polymer of 1000 monomers can contain up to about 30 modified monomers.

The sequence of the modified polynucleotide is one which is essentially complementary to the target polynucleotide. As used herein, the term "complementary or

substantially complementary" refers to the hybridization or base pairing between nucleotides or nucleic acids, such as, for instance, between the two strands of a double stranded DNA molecule or between an polynucleotide primer and a primer binding site on a single stranded nucleic acid to be sequenced or amplified. Complementary nucleotides are, generally, A and T (or A and U), or C and G. Two single stranded RNA or DNA molecules are said to be substantially complementary when the nucleotides of one strand, optimally aligned and compared and with appropriate nucleotide insertions or deletions, pair with at least about 80% of the nucleotides of the other strand, usually at least about 90% to 95%, and more preferably from about 98 to 100%.

Alternatively, substantial complementarity exists when an RNA or DNA strand will hybridize under selective hybridization conditions to its complement. Typically, selective hybridization will occur when there is at least about 65% complementarity over a stretch of at least 14 to 25 nucleotides, preferably at least about 75%, more preferably at least about 90% complementarity. See, M. Kanehisa, *Nucleic Acids Res.* 12:203 (1984).

Stringent hybridization conditions will typically include salt concentrations of less than about 1 M, more usually less than about 500 mM and preferably less than about 200 mM. Hybridization temperatures can be as low as 5°C, but are typically greater than 22°C, more typically greater than about 30°C, and preferably in excess of about 37°C. Longer fragments may require higher hybridization temperatures for specific hybridization. As other factors may affect the stringency of hybridization, including base composition and length of the complementary strands, presence of organic solvents and extent of base mismatching, the combination of parameters is more important than the absolute measure of any one alone.

Once a hybridized complex has formed between the boron-containing polynucleotide of the present invention and the target nucleic acid, the complex will be treated with a complexing agent which comprises a detectable moiety (label) or an indicator and a boronic acid complexing moiety.

A variety of boronic acid complexing moieties are useful in this aspect of the present invention. In order for complexing to occur, the complexing moiety should have functionality which can react with a boronic acid group to form a boronic acid ester, or diester. Alternatively, the boronic acid complex which is formed from the modified

polynucleotide and the complexing agent can comprise a boron-containing trivalent structure in which one of the boron ligands is the nitrogen of an amine group, an amide group or a hydroxamic acid ester group (see Figure 1). Accordingly, preferred functionality for the boronic acid complexing agent includes 1,2-diols, 1,3-diols, 1,2-aminoalcohols, 1,3-aminoalcohols, *ortho*-hydroxybenzohydroxamic acids, *ortho*-hydroxybenzoic acids, and *ortho*-hydroxybenzamides. A number of boronic acid complexing moieties have been described in WO 95/20591, WO 98/05627, WO 98/05629 and in United States Patents 5,594,111, 5,594,151, 5,623,055, 5,852,178, 5,859,210, 5,869,623, 5,872,224 and 5,877,297.

10

The complexing agents will further comprise a detectable moiety (label) or an indicator. The terms "detectable moiety" or "label" refer to a composition detectable by spectroscopic, photochemical, biochemical, immunochemical, or chemical means. For example, labels useful with a boronic acid complexing agent in hybridization assays include  $^{32}\text{P}$ ,  $^{35}\text{S}$ , fluorescent dyes, electron-dense reagents, enzymes (*e.g.*, as commonly used in an ELISA), biotin, dioxigenin, or haptens and proteins for which antisera or monoclonal antibodies are available.

15

A wide variety of labels suitable for use with nucleic acid hybridization and conjugation techniques described herein are known and are reported extensively in both the scientific and patent literature. Each of the groups of labels are generally applicable to the present invention for incorporation into a boronic acid complexing agent and subsequent labeling of target nucleic acids. Suitable labels include radionucleotides, enzymes, substrates, cofactors, inhibitors, fluorescent moieties, chemiluminescent moieties, magnetic particles, and the like. Labeling agents optionally include *e.g.*, monoclonal antibodies, polyclonal antibodies, proteins, or other polymers such as affinity matrices, carbohydrates or lipids. Detection of the resultant duplex nucleic acids proceeds by any known method, including immunoblotting, tracking of radioactive or bioluminescent markers, Southern blotting, northern blotting, southwestern blotting, northwestern blotting, or other methods which track a molecule based upon size, charge or affinity. The particular label or detectable group used and the particular assay are not critical aspects of the invention. The detectable moiety can

20

25

30

be any material having a detectable physical or chemical property. Such detectable labels have been well-developed in the field of gels, columns, solid substrates and in general, labels useful in such methods can be applied to the present invention. Thus, a label is any composition detectable by spectroscopic, photochemical, biochemical, immunochemical, electrical, optical or chemical means. Useful labels in the present invention include fluorescent dyes (*e.g.*, fluorescein isothiocyanate, Texas Red, rhodamine, and the like), radiolabels (*e.g.*,  $^3\text{H}$ ,  $^{125}\text{I}$ ,  $^{35}\text{S}$ ,  $^{14}\text{C}$ , or  $^{32}\text{P}$ ), enzymes (*e.g.*, LacZ, CAT, horse radish peroxidase, alkaline phosphatase and others, commonly used as detectable enzymes, either as marker gene products or in an ELISA), nucleic acid intercalators (*e.g.*, ethidium bromide) and colorimetric labels such as colloidal gold or colored glass or plastic (*e.g.* polystyrene, polypropylene, latex, *etc.*) beads.

The label is coupled directly or indirectly to the boronic acid complexing moiety according to methods well known in the art. As indicated above, a wide variety of labels are used, with the choice of label depending on the sensitivity required, ease of conjugation of the compound, stability requirements, available instrumentation, and disposal provisions. Non radioactive labels are often attached by indirect means. Generally, a ligand molecule (*e.g.*, biotin) is covalently bound to a polymer. The ligand then binds to an anti-ligand (*e.g.*, streptavidin) molecule which is either inherently detectable or covalently bound to a signal system, such as a detectable enzyme, a fluorescent compound, or a chemiluminescent compound. A number of ligands and anti-ligands can be used. Where a ligand has a natural anti-ligand, for example, biotin, thyroxine, and cortisol, it can be used in conjunction with labeled, anti-ligands. Alternatively, any haptenic or antigenic compound can be used in combination with an antibody. Labels can also be conjugated directly to signal generating compounds, *e.g.*, by conjugation with an enzyme or fluorophore. Enzymes of interest as labels will primarily be hydrolases, particularly phosphatases, esterases and glycosidases, or oxidoreductases, particularly peroxidases. Fluorescent compounds include fluorescein and its derivatives, rhodamine and its derivatives, dansyl, umbelliferone, *etc.* Chemiluminescent compounds include luciferin, and 2,3-dihydrophthalazinediones, *e.g.*, luminol. Means of detecting labels are well known to those of skill in the art. Thus, for example, where the label is a radioactive label, means for detection include a scintillation counter or photographic film as in autoradiography. Where the label is a fluorescent label, it may be detected by exciting the fluorochrome with the appropriate wavelength of light and

detecting the resulting fluorescence, e.g., by microscopy, visual inspection, via photographic film, by the use of electronic detectors such as charge coupled devices (CCDs) or photomultipliers and the like. For detection in VLSIPS™ arrays (see U.S. Patent No. 5,143,854)

5 fluorescent labels and detection techniques, particularly microscopy are preferred. Similarly, enzymatic labels may be detected by providing appropriate substrates for the enzyme and detecting the resulting reaction product. Finally, simple colorimetric labels are often detected simply by observing the color associated with the label. Thus, in various dipstick assays, conjugated gold often appears pink, while various conjugated beads appear the color of the bead. In some embodiments, the label will  
10 be contained in a liposome or latex carrier which is coupled to the boronic acid complexing moiety.

The labels or indicators and the boronic acid complexing moieties which together form the complexing agents are typically joined together by means of a covalent linkage or linking group. In one group of embodiments, the linking group will be similar  
15 to those described above for joining together a boronic acid moiety and the heterocyclic base of a nucleotide monomer. More particularly, the linking groups used in joining the components of a complexing agent will comprise from about 3 to about 30 carbon atoms, optionally interrupted by one or more amide, ester, disulfide, urea, carbamate, hydrazone, ether, thioether, amine or imine groups. A requirement of the linking group is that, when  
20 coupled to the detectable moiety or label, it does not interfere with the intended purpose or function of the label. Similarly, coupling of the linking group to the boronic acid complexing moiety should not interfere with the ability of the complexing moiety to react with a modified polynucleotide.

In one group of embodiments, the complexing agent will have the formula:

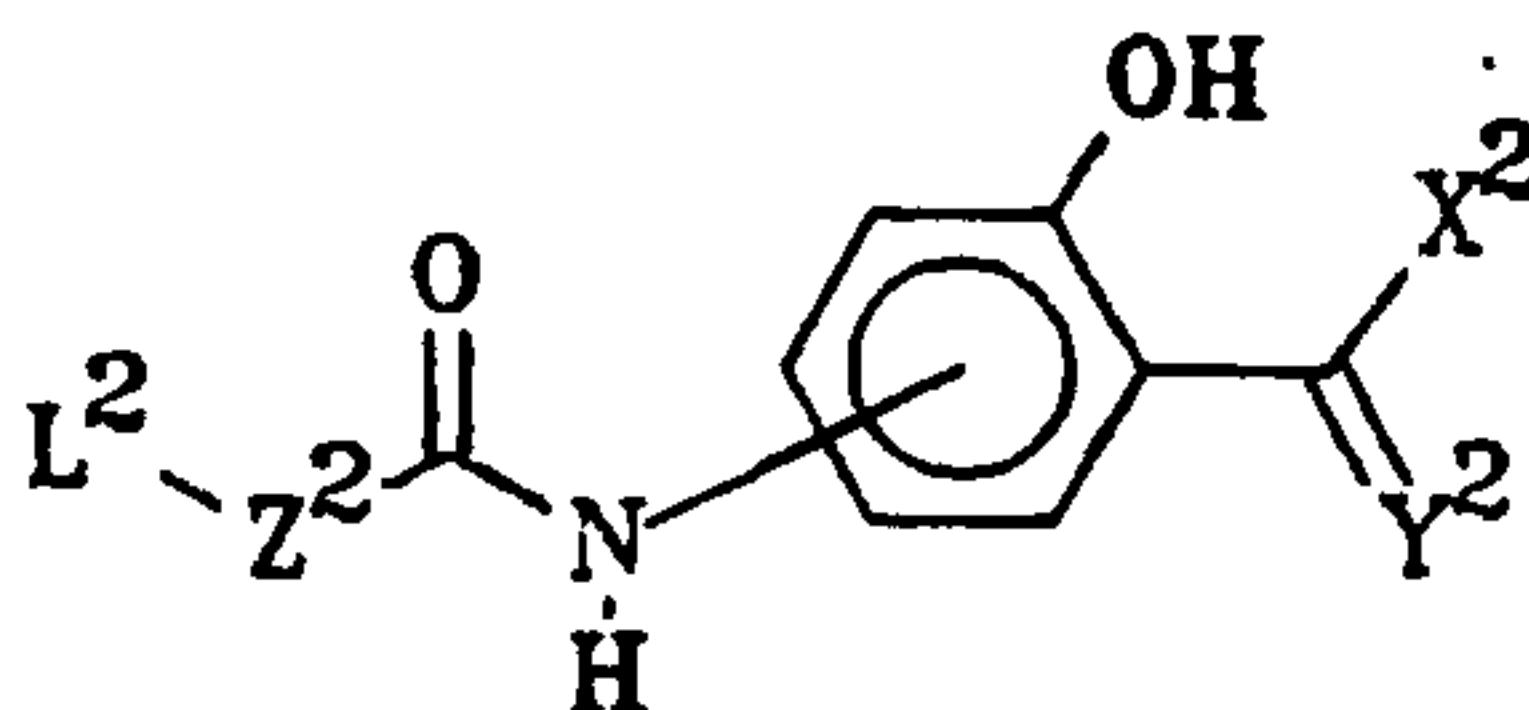

in which X<sup>2</sup> is OH, OR, NH<sub>2</sub>, NHR, NHOH or NHOR, in which R is an alkyl group of from one to six carbon atoms, either branched or straight chain. Y<sup>2</sup> is O, S or NH, preferably O. Z<sup>2</sup> is a linking group and L<sup>2</sup> is the label or indicator. Thus, the hydroxy-

substituted aromatic ring together with the functionality comprising X<sup>2</sup> and Y<sup>2</sup> is the boronic acid complexing moiety. The linking group in these embodiments is typically an alkylene chain having from one to ten carbon atoms, saturated or unsaturated, which is optionally interrupted by one or more disulfide bonds, esters or amides. Examples are provided in Figure 6. Thus, when the linking group is derived from an alkyl halide, a label having a pendant thiol group may be attached. Alternatively, when the linking group is derived from an ester, the ester can be converted to an acid hydrazide and attached to a label having a pendant aldehyde group (which can be the result of periodate oxidation of a carbohydrate). Still further, when the linking group is derived from a carboxylic acid, it may be further functionalized by reaction with dicyclohexylcarbodiimide (DCC) and an activating group such as, for example, N-hydroxysuccinimide (NHS) or N-hydroxysulfosuccinimide (SNHS). The resulting activated ester can be used to attach a label having a pendant amine moiety.

In particularly preferred embodiments, a complexing agent can be prepared by the methods outlined in Figure 7. For example, amino salicylic acid can be treated with methyl succinyl chloride to produce the amide 7a in Figure 7. Conversion of the carboxylic acid functionality to a N-methoxy benzamide followed by saponification of the ester results in 7b. Esterification with the activating group NHS provides a compound 7c. The activated compound 7c can be used to couple a label or an antibody, described in detail hereinbelow.

In another group of embodiments, the complexing agent will have the formula:

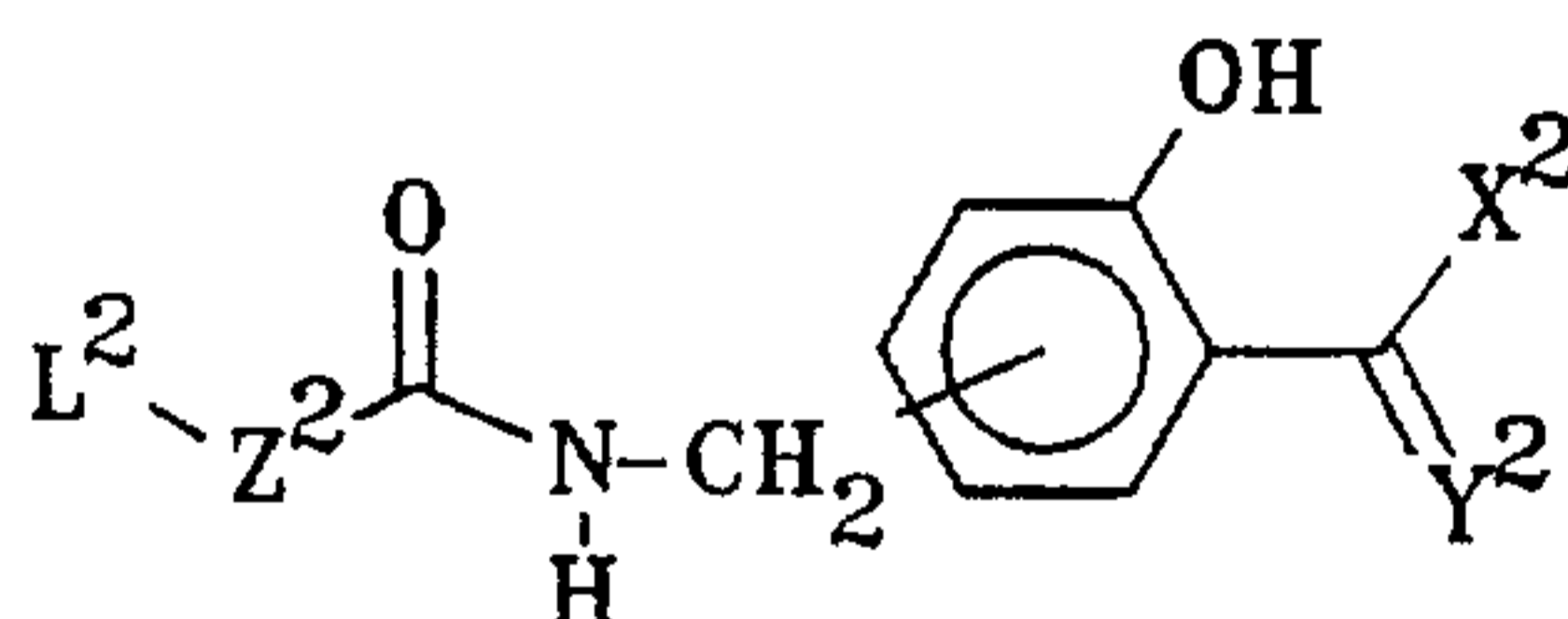

in which L<sup>2</sup>, X<sup>2</sup>, Y<sup>2</sup>, Z<sup>2</sup> and R are as described above. Complexing agents of this general formula can be prepared by standard synthetic methods using intermediates prepared as shown in Figures 8-12. In Figure 8, 3-, 4- or 5-methylsalicylic acid is esterified with methanol and acid, then brominated with N-bromosuccinimide. The resulting benzylic bromide is converted to a benzylic azide with sodium azide in DMF. Reduction of the azide to an amine is accomplished using catalytic hydrogenation. In Figure 9, transesterification of the benzoate ester is carried out by first protecting the amine as its *t*-butyl carbamate (*t*-BOC), saponification of the methyl ester, re-esterification with RX (in which X denotes a

leaving group such as a halide or tosylate), and cleavage of the protecting group. Figure 10 shows the conversion of the methyl ester (of Figure 8) to an alkylhydroxamic acid. In this scheme the amine is protected as its benzyloxycarbamate and the hydroxyl group is protected as its benzyl ether. The methyl ester is then saponified and the resulting acid is converted to its alkylhydroxamic acid. Removal of both protecting groups is accomplished with catalytic hydrogenolysis. The compounds produced in Figures 8-10 are then provided with additional linking groups and reactive functionality for the attachment of suitable labels as outlined in Figures 11 and 12. Selection of the appropriate reactive functionality and subsequent coupling of the label will depend on the functionality present on the label to be attached. Criteria for appropriate selection have been described above and are well known to those of skill in the art.

In yet another group of embodiments, the complexing agent will have the formula:

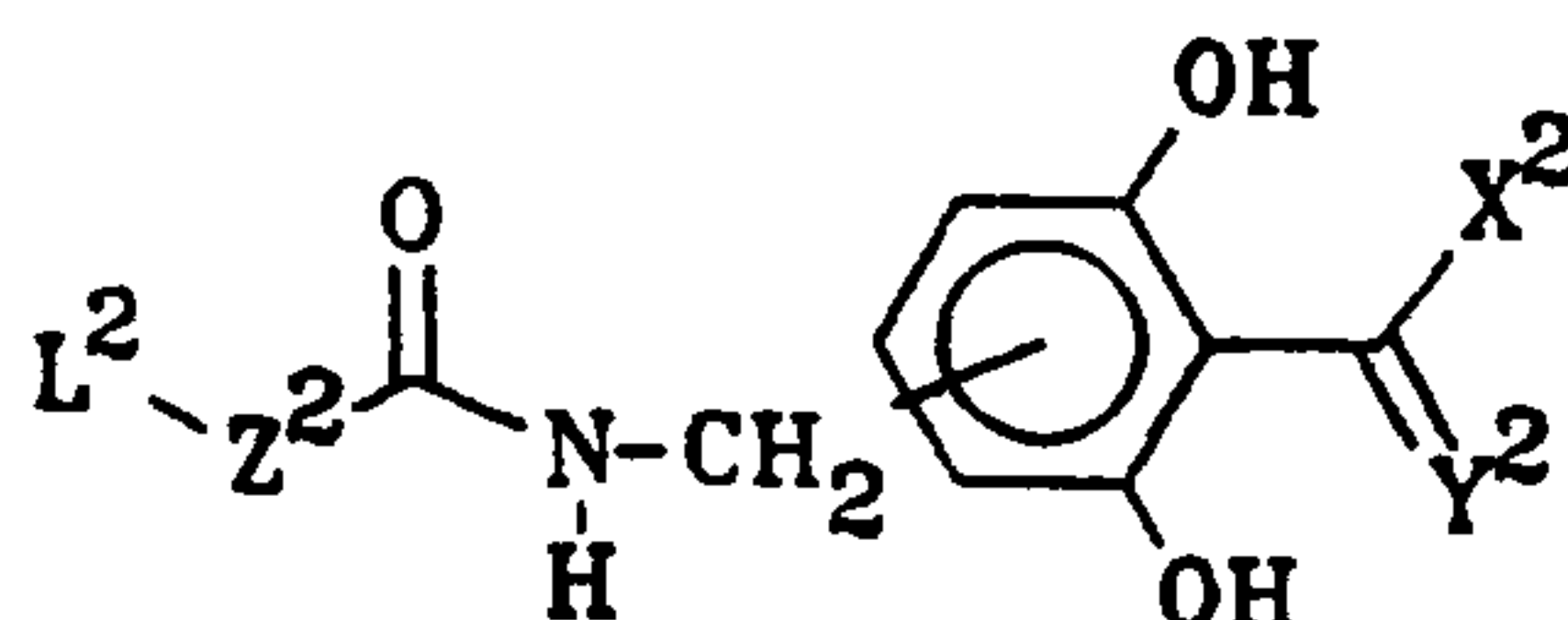

in which  $L^2$ ,  $X^2$ ,  $Y^2$ ,  $Z^2$  and R again have the meanings described above. Schemes for the preparation of intermediates are shown in Figures 13-17. Coupling of a label to and appropriate intermediate will follow methods described above and known to those of skill in the art.

In some preferred embodiments the label portion of the complexing agent will be a marker enzyme such as, for example, alkaline phosphatase and horseradish peroxidase (HRP). When alkaline phosphatase is used as the label or indicator, detection is typically achieved using a dye substrate, bioluminescence or chemiluminescence following techniques known to those of skill in the art. See, for example, Marich, *et al.* in NONRADIOACTIVE LABELING AND DETECTION OF BIOMOLECULES (Kessler, ed.) pp. 143-149, Springer-Verlag, Berlin/Heidelberg, and Miska, *et al.*, *J. Biolumin. Chemilumin.* 4:119-128 (1990).

Following contacting a complexing agent with a hybridized complex, any excess complexing agent is typically removed using conventional techniques such as, for



example, gel filtration or chromatography. The hybridized complex with the attached complexing agent can then be detected by conventional means as described above and in reviews such as NONISOTOPIC DNA PROBE TECHNIQUES, Academic Press, Chapter 1, Kricha, ed. (1992) and NONISOTOPIC PROBING, BLOTTING, AND SEQUENCING, Academic Press, Chapter 2, Kessler, ed. (1995).

In other aspects, the modified polynucleotides can be used for affinity purification of target polynucleotides. For example, a sample containing a target nucleic acid can be treated with a modified polynucleotide according to the present invention, under conditions wherein a duplex is formed. The resulting solution containing the duplex having an attached boronic acid moiety can be purified by placement on a solid support having attached boronic acid complexing agents. Materials which do not bind to the solid support can be removed and the target polynucleotide/duplex can then be stripped from the column by conventional methods (e.g., a boric acid wash).

15

The following examples are offered solely for the purposes of illustration, and are intended neither to limit nor to define the invention.

### EXAMPLE 1

This example illustrates the preparation of PBA-XX-dUTP.

20

#### 1.1 *Synthesis of PBA-X-NHS*

*3-Aminophenylboronic acid succinamic acid (PBA-X-CO<sub>2</sub>H).*

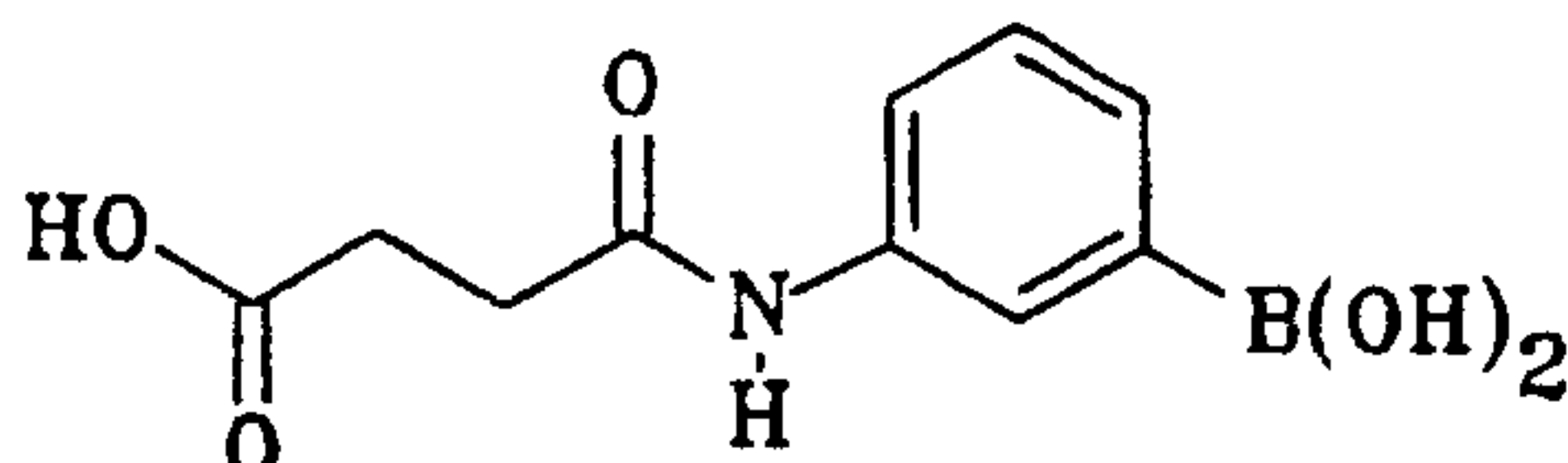

Synthesis of this material was accomplished using a modification of the procedure in Weith, *et al. Biochemistry* **9**:4396-4401 (1970). 3-Amino-phenylboronic acid hemisulfate (100 g, 0.535 moles) was suspended in anhydrous pyridine (240 mL). The mixture was stirred magnetically and chilled in an ice/water bath under an atmosphere of dry nitrogen. Succinic anhydride (56.5 g, 0.565 moles) was added to the flask, and the reaction mixture was allowed to warm to room temperature. After stirring overnight (at least 12 hours), all solids had dissolved. The majority of the pyridine was removed on a rotary evaporator (bath temperature  $\leq 55^{\circ}\text{C}$ ) to give a viscous, amber-colored syrup. The syrup was co-evaporated with water (100 mL), and the residue was then dissolved in water (700 mL). The amber solution was chilled in an ice-water bath, and concentrated hydrochloric acid (30-50 mL) was added slowly to yield a final pH of 1 (pH paper). During this addition, a white solid precipitated. The suspension was chilled for 1 hour at  $4^{\circ}\text{C}$ . The solid was filtered and washed with cold water (100 mL). The solid was then crystallized from hot water, and dried *in vacuo* over KOH pellets. Yield: 100 g (80%); m.p.  $171-172^{\circ}\text{C}$  (open capillary, uncorrected).  $^1\text{H}$  NMR (300 MHz, DMSO- $d_6$ ):  $\delta$  12.07 (broad singlet, 1H,  $\text{CO}_2\text{H}$ ), 9.83 (singlet, 1H, ArNHCOR), 7.95 (singlet, 2H, BOH), 7.67 (singlet, 1H, ArH), 7.65 (doublet,  $J = 7.9$  Hz, 1H, ArH), 7.41 (doublet,  $J = 7.0$  Hz, 1H, ArH), 7.20 (apparent triplet,  $J = 7.8$  Hz, 1H, ArH), 2.60-2.40 (multiplet, 4H,  $\text{COCH}_2$ ).  $^{13}\text{C}$  NMR (75.5 MHz, DMSO- $d_6$ )  $\delta$  174.2, 170.2, 138.7, 129.0, 127.8, 125.2, 121.2, 31.0, 28.9. HPLC: Retention time of product,  $8.6 \pm 0.1$  minutes using an Applied Biosystems/Brownlee Aquapore Butyl 2.1 x 220 mm cartridge, and a mixed gradient elution as follows: A, 0.1 M triethylammonium acetate, pH 6.5; B, methanol at a flow rate of 0.5 mL/minute beginning with 100% A/0% B, for 5 minutes, then to 0% A/100% B over 30 minutes at ambient temperature. Detection was carried out using a diode array detector: 260 nm, 280 nm, 300 nm. The sample amount was 5 mg/mL in methanol.

*Trimethylene-3-aminophenylboronate succinamic acid succinimidyl ester (PBA-X-NHS)*

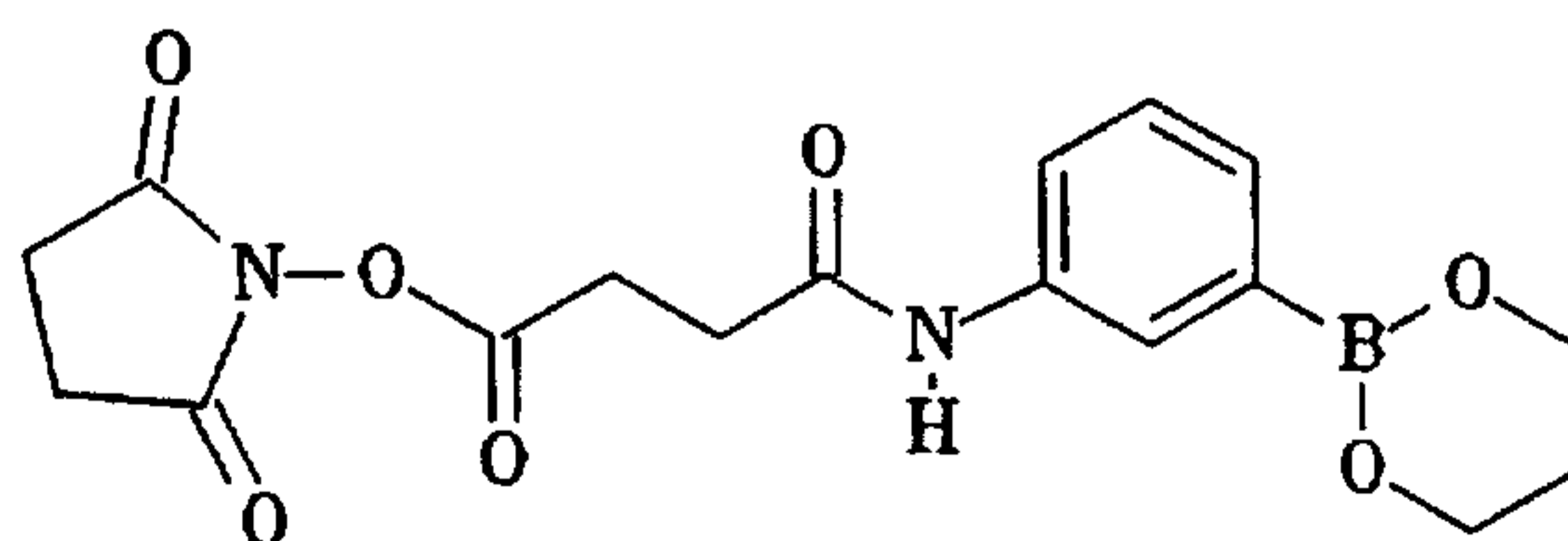

Synthesis of this material was accomplished using a modification of the procedure in Ho, *et al. Biochemistry* **20**:64-67 (1981). PBA-X-CO<sub>2</sub>H (28.4 g, 0.120 moles) was suspended in dry dioxane (120 mL), and 1,3-propanediol (9.1 g, 0.120 moles) was added. The mixture was gently heated until all solid dissolves (about 10 minutes). The solvent was removed by rotary evaporation to leave a pale yellow syrup, which was co-evaporated twice with dioxane (50 mL each). The residue was then dissolved in dioxane (450 mL) and N-hydroxysuccinimide (14.9 g, 0.130 moles) was added, followed by N,N-dicyclohexylcarbodiimide (26.3 g, 0.128 moles). The solution was stirred under an atmosphere of dry nitrogen for 4 hours at room temperature, during which time the white precipitate of N,N-dicyclohexylurea formed. The precipitate was filtered and washed with dioxane (50 mL). The combined filtrates were concentrated to about 100 mL. Dry diethyl ether (400 mL) was slowly added to the stirred concentrate, causing precipitation of a white solid. The mixture was chilled in an ice/water bath for 1 hour, then filtered. The solid was washed with dry ether (100 mL), and dried *in vacuo*. Yield: 42.5 g (95%); m.p. 163-170°C (open capillary, uncorrected). <sup>1</sup>H NMR (300 MHz, DMSO-d<sub>6</sub>): δ 9.99 (singlet, 1H, ArNHCOR), 7.87 (singlet, 1H, ArH), 7.65 (doublet, *J* = 8.0 Hz, 1H, ArH), 7.32 (doublet, *J* = 7.3 Hz, 1H, ArH), 7.22 (triplet, *J* = 7.6 Hz, 1H, ArH), 4.09 (triplet, *J* = 5.4 Hz, 4H, BOCH<sub>2</sub>CH<sub>2</sub>), 2.95 (triplet, *J* = 6.7 Hz, 2H, succinyl COCH<sub>2</sub>), 2.79 (singlet, 4H, succinimidyl COCH<sub>2</sub>), 2.69 (triplet, *J* = 6.7 Hz, 2H, succinyl COCH<sub>2</sub>), 1.98 (quintet, *J* = 5.4 Hz, 2H, BOCH<sub>2</sub>CH<sub>2</sub>). <sup>13</sup>C NMR (75.5 MHz, DMSO-d<sub>6</sub>): δ 174.4, 169.0, 168.9, 138.7, 128.4, 128.1, 124.3, 121.4, 61.6, 30.3, 26.9, 25.7, 25.4.

### 1.2 Synthesis of PBA-XX-NHS

#### 3-Aminophenylboronic acid succinamidohexanoic acid (PBA-XX-CO<sub>2</sub>H)

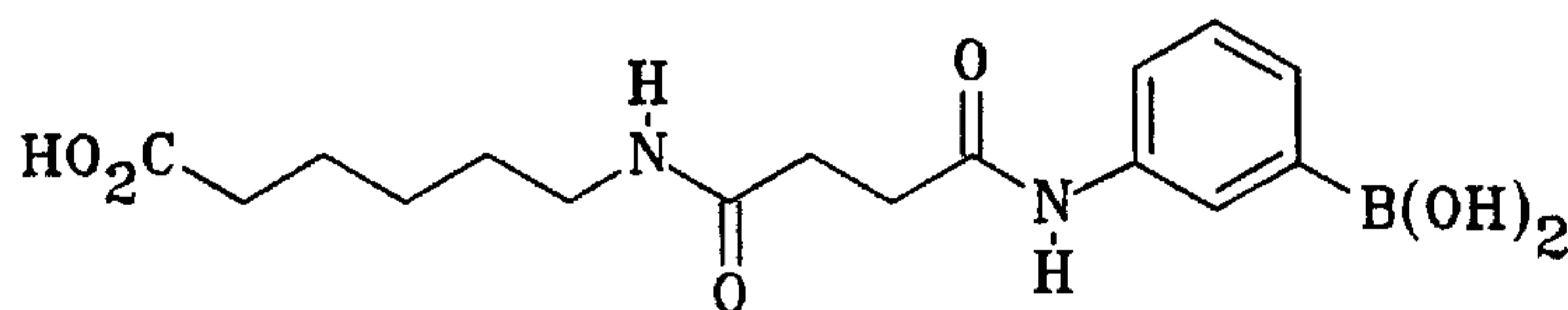

6-Aminohexanoic acid (5.8 g, 0.044 moles) was suspended in dry dioxane (300 mL), and N,N-diisopropylethylamine (15 mL) was added. The suspension was briskly

stirred while being chilled in an ice/water bath. PBA-X-NHS (15.0 g, 0.040 moles) was added, and the mixture was stirred under dry nitrogen for 5 minutes. Methanol (300 mL) was then added, the ice bath was removed, and the reaction was allowed to warm to room temperature. After 1 hour, most of the solid has dissolved, and the reaction mixture was evaporated to dryness to leave a pale yellow syrup. This syrup was co-evaporated twice with water (40 mL each) and then dissolved in water (120 mL). The aqueous solution was chilled in an ice/water bath, and the solution was titrated to about pH 1 with concentrated hydrochloric acid (about 1 mL). A white precipitate formed during this time. The suspension was chilled for an additional hour and then filtered. The solid was washed with cold water (10 mL) and then dried *in vacuo* over KOH pellets. Yield: 10.0 g (70%); m.p. 174-177°C (open capillary, uncorrected). <sup>1</sup>H NMR (300 MHz, DMSO-d<sub>6</sub>): δ 11.98 (singlet, 1H, CO<sub>2</sub>H), 9.84 (singlet, 1H, ArNHCOR), 7.97 (singlet, 2H, BOH), 7.83 (triplet, *J* = 5.4 Hz, 1H, CONHCH<sub>2</sub>), 7.81 (singlet, 1H, ArH), 7.68 (doublet, *J* = 8.2 Hz, 1H, ArH), 7.44 (doublet, *J* = 7.3 Hz, 1H, ArH), 7.22 (doublet of doublets, *J* = 7.8 Hz, 1H, ArH), 3.00 (apparent quartet, *J* = 6.3 Hz, 2H, CONHCH<sub>2</sub>), 2.52 (triplet, *J* = 7.1 Hz, 2H, COCH<sub>2</sub>), 2.36 (triplet, *J* = 7.1 Hz, 2H COCH<sub>2</sub>), 2.17 (triplet, *J* = 7.3 Hz, 2H CH<sub>2</sub>CH<sub>2</sub>CO<sub>2</sub>H), 1.50-1.41 (multiplet, 2H, NHCH<sub>2</sub>CH<sub>2</sub>), 1.39-1.32 (multiplet, 2H, CH<sub>2</sub>CH<sub>2</sub>CO<sub>2</sub>H), 1.28-1.23 (multiplet, 2H, CH<sub>2</sub>CH<sub>2</sub>CH<sub>2</sub>). <sup>13</sup>C NMR (75.5 MHz, DMSO-d<sub>6</sub>): δ 174.7, 171.3, 170.6, 138.7, 128.9, 127.8, 125.2, 121.2, 38.4, 33.6, 31.7, 30.4, 28.9, 26.0, 24.2. HPLC: Retention time of product, 14.3 ± 0.1 minutes using an Applied Biosystems/Brownlee Aquapore Butyl 2.1 x 220 mm cartridge, and gradient elution as follows: Eluant A, 0.1 M triethylammonium acetate, pH 6.5, and B, methanol, at a flow rate of 0.5 mL/minute with 100% A/0% B, 5 minutes, then to 0% A/100% B over 30 minutes at ambient temperature. Detection of the product was carried out using a diode array detector: 260 nm, 280 nm, 300 nm.

*Trimethylene-3-aminophenylboronate succinamidohexanoic acid succinimidyl ester (PBA-XX-NHS)*

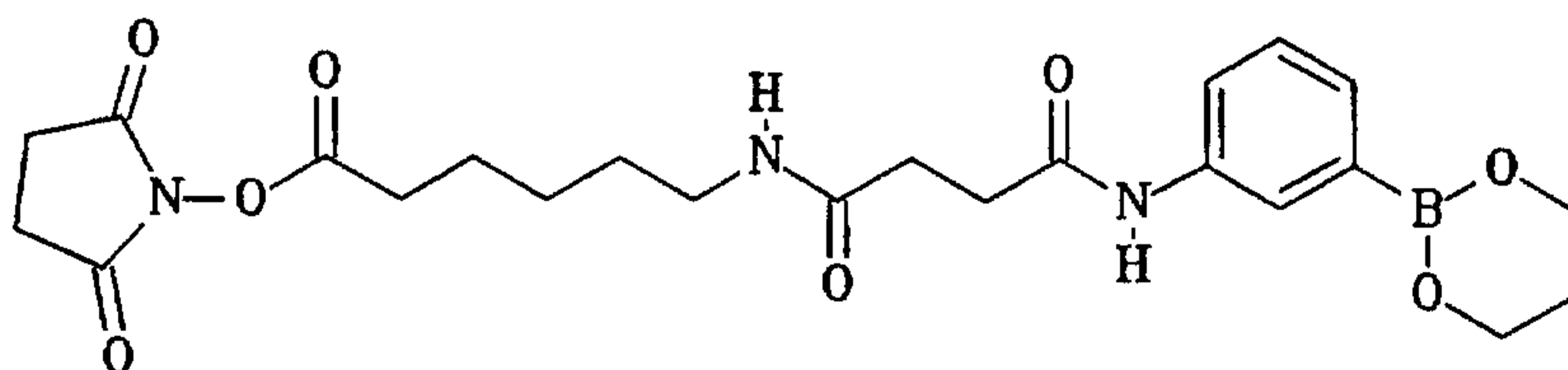

PBA-XX-CO<sub>2</sub>H (6.3 g, 0.018 moles) was suspended in dry dioxane (60 mL). 1,3-Propanediol (1.4 g, 0.018 moles) was added, and the mixture was gently heated until all solid dissolves (about 10 minutes). The solvent was removed by rotary evaporation to leave a pale yellow syrup, which was co-evaporated twice with dioxane (30 mL each). The residue was then dissolved in dioxane (225 mL) and N-hydroxysuccinimide (2.3 g, 0.20 moles) was added, followed by N,N-dicyclohexylcarbodiimide (4.1 g, 0.020 moles). The solution was stirred under an atmosphere of dry nitrogen for 6 hours at room temperature, during which time the white precipitate of N,N-dicyclohexylurea formed. The precipitate was filtered and washed with dioxane (50 mL). The combined filtrates were concentrated to about 30 mL. Dry diethyl ether (200 mL) was slowly added to the stirred concentrate, causing precipitation of a white solid. The mixture was chilled in an ice/water bath for 1 hour, then filtered. The solid was washed with dry ether (50 mL), and dried *in vacuo*. Yield: 8.0g (91 %); M.P. 111-117°C (open capillary, uncorrected). <sup>1</sup>H NMR (300 MHz, DMSO-d<sub>6</sub>) δ 9.85 (singlet, 1H, ArNHCOR), 7.85 (singlet, 1H, ArH), 7.82 (triplet, *J* = 5.7 Hz, 1H, CONHCH<sub>2</sub>), 7.64 (doublet, *J* = 7.9 Hz, 1H, ArH), 7.29 (doublet, *J* = 7.3 Hz, 1H, ArH), 7.22 (doublet of doublets, *J* = 7.6 Hz, 1H, ArH), 4.07 (triplet, *J* = 5.4 Hz, 4H, BOCH<sub>2</sub>CH<sub>2</sub>), 3.05-2.95 (multiplet, 2H, CONHCH<sub>2</sub>), 2.79 (singlet, 4H succinimidyl COCH<sub>2</sub>), 2.62 (triplet, *J* = 7.3 Hz, 2H, CH<sub>2</sub>CO<sub>2</sub>.R), 2.50 (triplet, *J* = 6.7 Hz, 2H, NHCOCH<sub>2</sub>), 2.36 (triplet, *J* = 6.7 Hz, 2H, NHCOCH<sub>2</sub>), 1.50-1.41 (multiplet, 2H, NHCH<sub>2</sub>CH<sub>2</sub>), 1.97 (quintet, *J* = 5.4 Hz, 2H, BOCH<sub>2</sub>CH<sub>2</sub>), 1.61-1.51 (multiplet, 2H, CH<sub>2</sub>), 1.41-1.30 (multiplet, 4H, CH<sub>2</sub>). <sup>13</sup>C NMR (75.5 MHz, DMSO-d<sub>6</sub>) δ 171.3, 170.6, 170.5, 169.2, 138.9, 128.1, 128.0, 124.3, 121.4, 61.5, 38.2, 31.7, 30.4, 30.1, 28.6, 26.8, 25.4, 23.9, 15.1. HPLC: Retention time of product, 18.2 ± 0.1 minutes under the conditions described above.

### 1.3 Synthesis of 5-aminoallyl-dUTP

Synthesis of this material was accomplished using a modification of the procedure in Langer, *et al.*, *Proc. Natl. Acad. Sci. USA*, 78:6633-6637 (1981).

#### 5-Chlormercurideoxyuridine 5'-triphosphate (5-ClHg-dUTP)

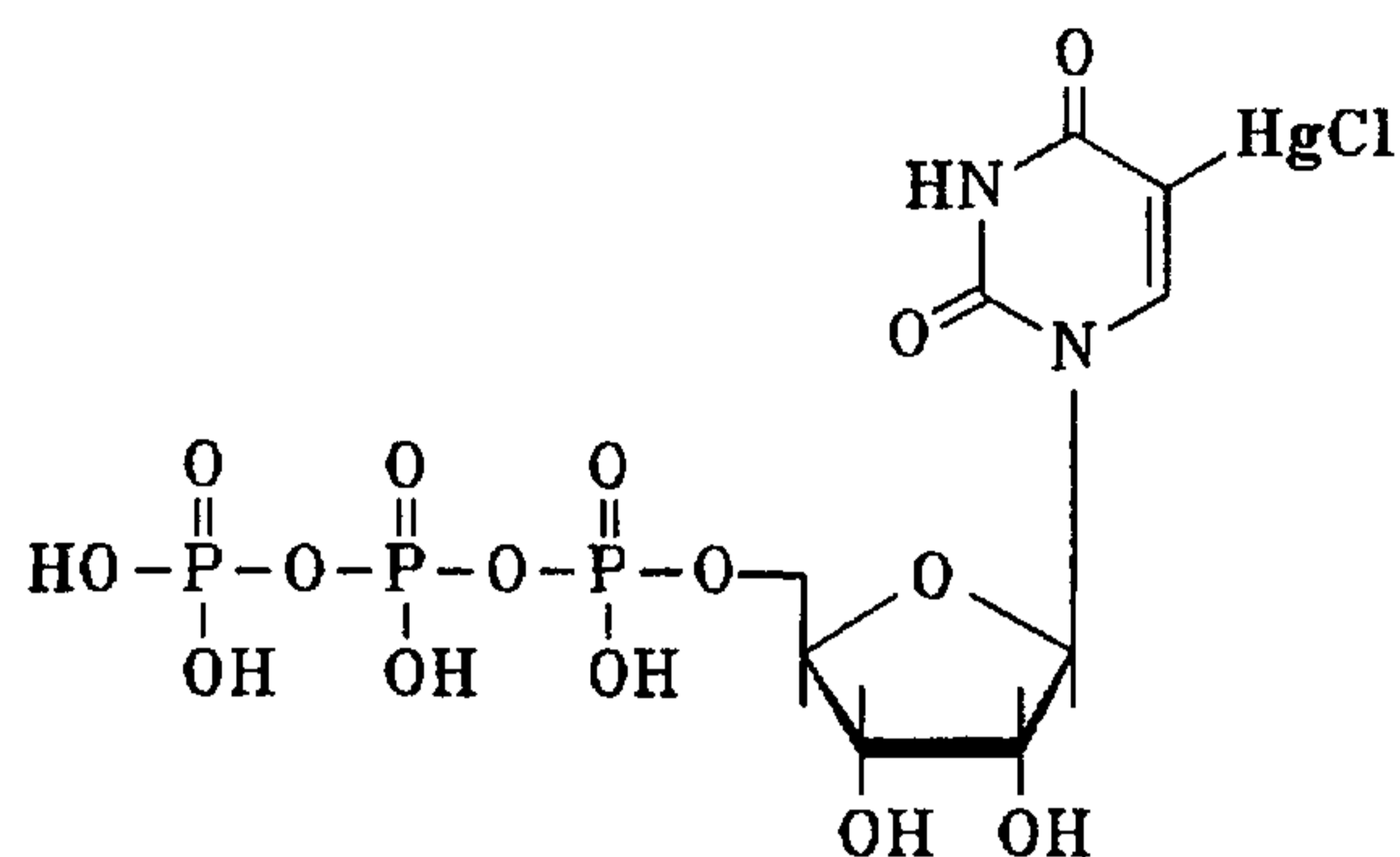

Deoxyuridine 5'-triphosphate (600 mg, about 1 mmole) was dissolved in 0.1 M aqueous sodium acetate, pH 6.0 (100 mL). The solution was warmed in an oil bath (bath temperature 50-55°C), and mercuric chloride (1.6 g, 5 mmoles) was added. The solution was stirred at 50-55°C for 4 hours, then cooled to room temperature. Lithium chloride (424 mg, 10 mmoles) was added, and the solution was stirred for 30 minutes. During this time, the solution turned cloudy. The aqueous mixture was then extracted five times with ethyl acetate (100 mL each). Following the extractions, the aqueous solution was chilled in an ice/water bath, stirred briskly, and ice-cold ethanol (400 mL) was added. A fluffy white precipitate forms. The solid was collected at -20°C overnight, then filtered, washed with cold ethanol (150 mL) and then diethyl ether (100 mL), and dried *in vacuo* at 60°C. Yield: 772 mg.  $\lambda_{\max}$ : 267 nm [ $\epsilon \equiv 10,000 \text{ M}^{-1} \text{ cm}^{-1}$ ] (0.1 M sodium acetate, pH 5.0)

*5-Aminoallyldeoxyuridine 5'-triphosphate (5-AA-dUTP).*

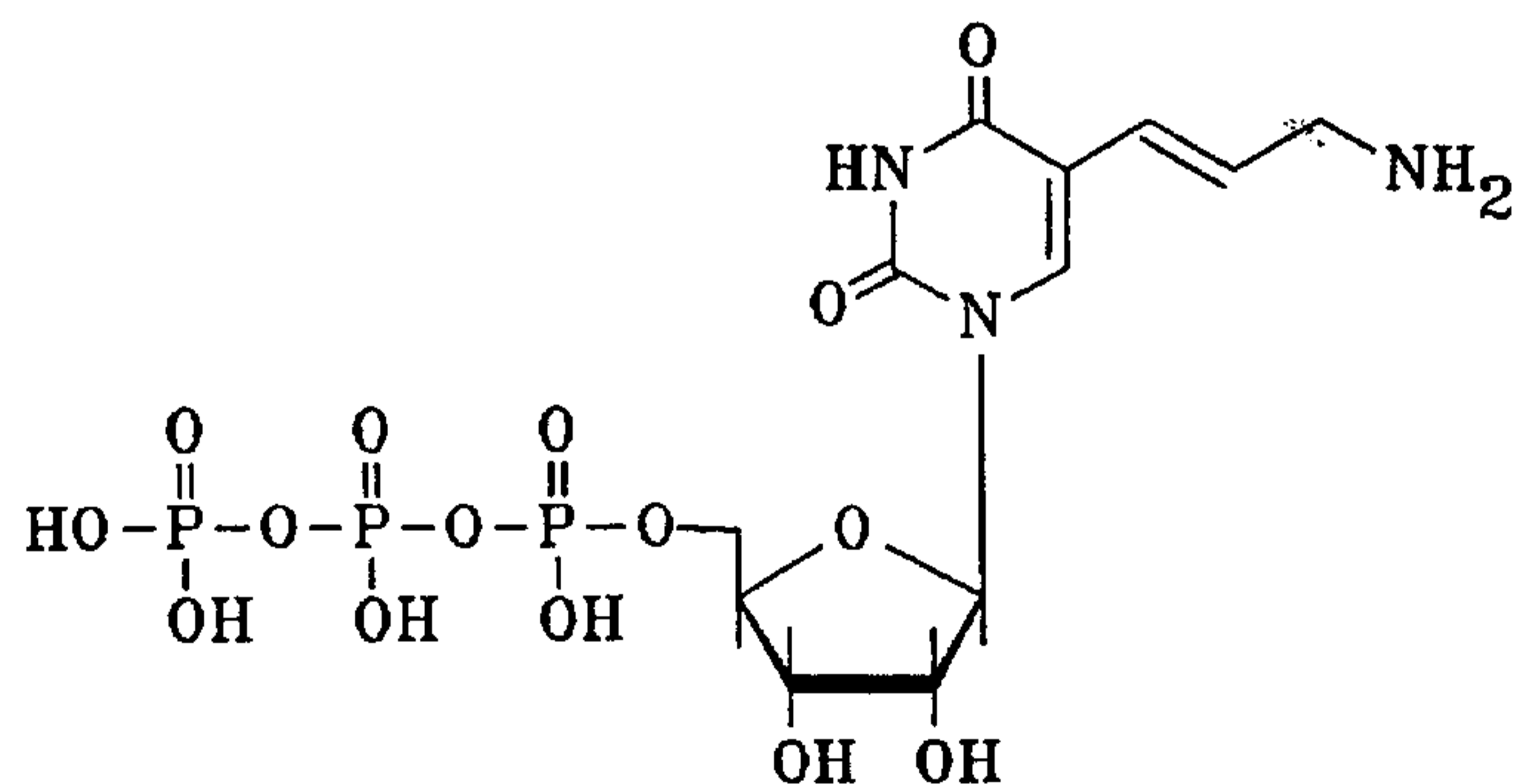

5-CIHg-dUTP (160 mg) was dissolved in 0.1 M aqueous sodium acetate, pH 5.0 (10 mL), to give a slightly cloudy solution. An aliquot (5 mL) of this solution was diluted with 0.1 M sodium acetate, pH 5.0 (1.0 mL), and the ultraviolet spectrum was measured. The concentration of the stock 5-CIHg-dUTP solution was then calculated from the extinction coefficient and the dilution factor to be 20 mM, or 200  $\mu$ moles 5-CIHgdUTP in the 10 mL of solution. An aliquot (1.2 mL, 2.4  $\mu$ moles) of a fresh, ice-cold solution of allylamine (1.5 mL) in 4 M aqueous acetic acid (8.5 mL) was then added to the stirred 5-CIHg-dUTP solution, followed by a solution of potassium tetrachloropalladate (65 mg, 200  $\mu$ moles) in water (1.6 mL). The reaction mixture darkens rapidly, and a black precipitate forms. The reaction was allowed to proceed for 4 hours at room temperature, then overnight at 4°C. The mixture was filtered through a 0.45 mm nylon membrane. The product was isolated from the pale yellow filtrate by ion exchange HPLC, using an Alltech HEMA-IEC BIO 1000 DEAE column, 250 x 7.5 mm, and a gradient of 0.0 M to 0.5 M lithium chloride in 25 mM MES buffer, pH 6.1, over 20 minutes. The flow rate was 2.0 mL/minute. Absorbance was monitored at 320 nm. A 1.0 mL aliquot of the filtrate was injected for each run. The peak at about 13 minutes contained the desired product and was collected. The product fractions were combined and concentrated to about 5 mL. Ice-cold ethanol (20 mL) was added to the product solution, and a white precipitate formed. The mixture was chilled at -20°C overnight. The precipitate was pelleted by centrifugation (3000 rpm, 20 minutes, 4°C). The supernatant was decanted and the pellet was dissolved in 0.5 mL of deionized water. The concentration of the product solution was calculated from the absorbance at 290 nm ( $\epsilon \equiv 7100 \text{ M}^{-1} \text{ cm}^{-1}$ ). The yield was about 30%. This stock solution was stored frozen.  $\lambda_{\text{max}}$ : 240, 290 nm;  $\lambda_{\text{min}}$ : 264 nm (water).

#### 1.4 Synthesis of PBA-XX-dUTP

25 *5-(3-aminophenylboronic acid succinamidohexanoyl)-aminoallyldeoxy-uridine 5'-triphosphate (PBA-XX-dUTP)*

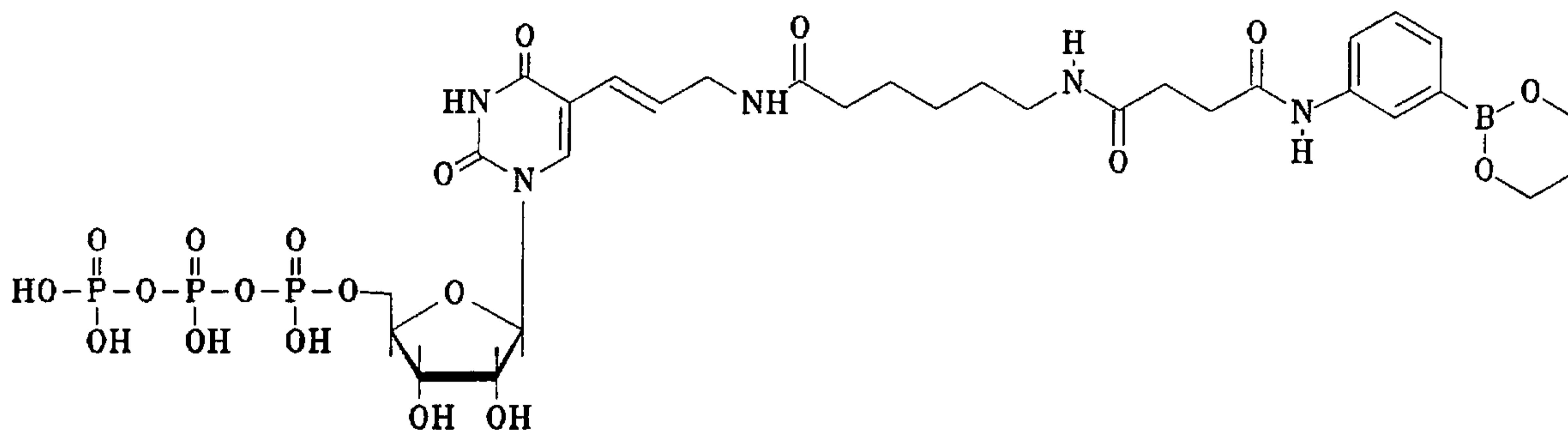

5-AA-dUTP (475 mL of stock solution in water, about 51  $\mu$ moles) was mixed with 1 M aqueous sodium bicarbonate, pH about 8.5 (100 mL), and the solution was chilled in an ice/water bath. PBA-XX-NHS (25 mg, 51  $\mu$ moles) in dry N,N-dimethylformamide (100  $\mu$ L) was added and the well-mixed reaction was allowed to sit at room temperature for 1 hour, then at 4°C overnight. The product was isolated by reverse phase HPLC, using an Applied Biosystems/Brownlee Aquapore Butyl column, 220 x 10 mm, and a gradient of methanol in 0.1 M triethylammonium acetate buffer, pH 6.5, over 20 minutes. The flow rate was 4.0 mL/minute. Absorbance was monitored at 260 nm. A 0.1 mL aliquot of the reaction mixture was injected for each run. Two major peaks were observed; the peak at about 18 minutes contained the desired product and was collected. The product fractions were combined and concentrated to about 0.5 mL. Ice-cold acetone (6 mL) was added to the product solution, and a white precipitate formed. The mixture was chilled at -20°C overnight. The precipitate was pelleted by centrifugation (3000 rpm, 20 minutes, 4°C). The supernatant was decanted and the pellet was dissolved in 0.5 mL of deionized water. The concentration of the product solution was calculated from the absorbance at 290 nm ( $\epsilon \equiv 7000 \text{ M}^{-1} \text{ cm}^{-1}$ ). The yield was about 50%. This stock solution was stored frozen.  $\lambda_{\text{max}}$ : 251, 290 nm;  $\lambda_{\text{min}}$ : 271 nm (water). HPLC: Retention time of product,  $20.4 \pm 0.1$  minutes using the column, flow rate, buffers/solvents and detection as above. The gradient used was 100% A/0% B, 10 minutes, then to 50% A/50% B over 20 minutes.

PBA-X-dUTP can be prepared in a similar manner by substituting PBA-X-NHS (described above) for PBA-XX-NHS in the above reaction.



## EXAMPLE 2

This example provides alternative methods for the preparation of modified polynucleotides using PCR with PBA-XX-dUTP; nick-translation with NH<sub>2</sub>-dATP followed by reaction with an NHS-activated PBA group; and incorporation of PBA-XX-dUTP into oligonucleotides using random primed labeling, nick translation and terminal transfer tailing.

### 2.1 PCR reaction

The protocol for the PCR reaction was a modification of the polymerase chain reaction described by Saiki, *et al.*, *Science* 239:487-494 (1988). PCR primers (21mers) for the amplification of lambda DNA sequence 6371 - 7172, were synthesized with either a 5'-biotin label, three or four 5'-PBA labels, or no label. PBA was incorporated into an 801bp product by polymerase insertion of PBA-XX-dUTP or by extension of PBA-labeled primer.

A standard PCR reaction for the incorporation of PBA-XX-dUTP was set up as follows: Lambda DNA was suspended (167 ng/mL) in 1XPCR buffer (Perkin Elmer, Foster City, California, USA), 1.5 mM MgCl<sub>2</sub>, 200 μM dATP, 200 μM dCTP, 200 μM dGTP, 200 μM PBA-XX-dUTP, 1 μM biotin-6371 primer, 1 μM 7172-primer and 8.3 U/mL Taq DNA polymerase (Perkin Elmer). The PCR reaction mixture was placed in a thermocycler (Perkin Elmer) programmed with an initial 1-7 minute denaturation cycle (92°C), followed by 30-35 cycles of denaturation (10 sec, 95°C), annealing (20 sec, 62°C), and extension (30 sec, 72°C). After a final extension of 5 minutes (72°C), the PCR reaction was held at 4°C. Approximately 50-100 ng of amplified product (801bp) were produced. The PCR samples described above were mixed with DHBHA-Sepharose for 15 min at room temperature. The eluants from the DHBHA-Sepharose were compared to the starting PCR sample by electrophoresis on a 1% agarose, 10 μg/mL ethidium bromide, 50 mM Tris, 100 mM borate, 2 mM EDTA, pH 8.3 gel (see Figure 18). The control PCR product (lane 1) did not bind substantially to the DHBHA-Sepharose (lane 2), while the PBA-XX-dUTP containing PCR products were bound quantitatively (lanes 4, 6 and 8) compared to the starting samples (lanes 3, 5 and 7, respectively).

A standard PCR reaction for the extension of a PBA-labeled primer was set up as follows: Lambda DNA was suspended (167 ng/mL) in 1XPCR buffer (Perkin Elmer),

1.5 mM MgCl<sub>2</sub>, 200 μM dATP, 200 μM dCTP, 200 μM dGTP, 200 μM dTTP, 1 μM biotin-6371 primer, 1 μM PBA-labeled 7172-primer, and 8.3 U/mL Taq DNA polymerase (Perkin Elmer). The PCR reaction mixture was placed in a thermocycler (Perkin Elmer) programmed with a 1 minute denaturation cycle (92°C), followed by 30-35 cycles of denaturation (10 sec, 95°C), annealing (20 sec, 62°C), and extension (30 sec, 72°C). After a final extension of 5 minutes (72°C), the PCR reaction was held at 4°C. Approximately 200 - 400 ng of amplified product (801bp) were produced, with no apparent retarding of mobility relative to unmodified PCR product on a 1% agarose, 50 mM Tris, 100 mM borate, 2 mM EDTA, pH 8.3 gel. Figure 19 is a gel which compares PBA-labeled probes prepared by the alternative methods. In lane 1 is a standard 1Kb ladder. Lane 2 is the product of PBA-XX-dUTP insertion into an 801 bp product. Lanes 3-9 contain products prepared by insertion reactions using mixtures of PBA-XX-dUTP and dTTP. Lane 10 is the product prepared by extension of a PBA-labeled primer.

## 2.2 Preparation of PBA-labeled probe from NH<sub>2</sub>-dATP labeled nucleic acid

A nick translation reaction, a modification of the reaction described by Rigby, *et al.*, *Journal of Molecular Biology* 113:237-251 (1977), was performed with N<sup>6</sup>-(6-aminohexyl)-dATP. One microgram of linear pBR322 DNA was suspended in 0.1 mM N<sup>6</sup>-(6-aminohexyl)-dATP (Gibco BRL, Gaithersburg, Maryland, USA), 0.125 mM dCTP, 0.125 mM dGTP, 0.125 mM dTTP, 1X buffer (Boehringer Mannheim, Indianapolis, Indiana, USA), and 1/10 volume DNAaseI/DNA polymerase mix (Boehringer Mannheim). The reaction was incubated for 90 min at 15°C and stopped by the addition of EDTA (50 mM). The amine-labeled DNA was precipitated by adding tRNA carrier (10 μg), one-tenth volume 4M LiCl, and 2.6 volumes of ethanol (10-20 min, -20°C). After centrifugation for 15 min at 14,000 rpm (5°C), the supernatant was decanted and the pellet was washed briefly in 70% ethanol (5°C). The pellet was dried briefly, suspended in 30-40 μL of deionized H<sub>2</sub>O and adjusted to 7 mg/mL NHS-PBA, 0.36 M NaHCO<sub>3</sub>, 35% dimethyl formamide. After one hour at room temperature, a portion of the NHS-ester reacted DNA was precipitated by LiCl/ethanol precipitation. The resulting DNA pellet was suspended in a small volume of deionized H<sub>2</sub>O. The purified or the crude NHS-reacted DNA was used in hybridizations to pBR322 DNA immobilized on a nylon membrane.

### 2.3 Preparation of PBA-labeled probes

#### (a) Random prime labeling

The random prime labeling reaction was a modification of Feinberg, *et al.*, *Anal. Biochem.* **132**:6-13 (1983), using PBA-XX-dUTP in place of dTTP. One microgram of DNA was denatured (100°C, 10 min). The DNA was quick chilled in a dry ice/ethanol bath. Two  $\mu\text{L}$  of 10X hexanucleotide mix (Boehringer Mannheim) and 2  $\mu\text{L}$  of 10X dNTP labeling mix (1 mM dATP, 1 mM dCTP, 1 mM dGTP, 1 mM PBA-XX-dUTP) were added. The mixture was thawed and 1  $\mu\text{L}$  of Klenow was added. The sample was incubated (37°C) for 2-16 h and the reaction was stopped by the addition of EDTA (50 mM). Incorporation of PBA-XX-dUTP was verified by capture of the probe on DHBHA-Sepharose, demonstrated by electrophoresis of the eluants on a 1% agarose, 10  $\mu\text{g}/\text{mL}$  ethidium bromide, 50 mM Tris, 100 mM borate, 2 mM EDTA, pH 8.3 gel (see Figure 20). DNA labeled with dTTP (lane 1) was not captured by DHBHA-Sepharose (lane 2). However, DNA labeled with PBA-XX-dUTP (lane 3) was quantitatively captured by DHBHA-Sepharose (lane 4).

#### 15 (b) Terminal deoxynucleotidyl transferase

The terminal transferase reaction was a modification of the reactions described by Abhay, *et al.*, *Anal. Biochem.* **169**:376-382 (1988), using PBA-XX-dUTP diluted into dTTP.

One microgram of polynucleotide was suspended in 2 mM dATP, 2 mM dCTP, 2 mM dGTP, and 2 mM PBA-XX-dUTP or 2 mM PBA-XX-dUTP + dTTP, 1.5 mM  $\text{COCl}_2$ , 1X TdT buffer (Boehringer Mannheim), and 25 U terminal deoxynucleotidyl transferase. The reaction was incubated at 37°C for 1-16 h and stopped by the addition of EDTA (50 mM). Incorporation was verified by capture of probe on DHBHA-Sepharose (not shown) or by mobility shift on a 1% agarose, 10  $\mu\text{g}/\text{mL}$  ethidium bromide, 50 mM Tris, 100 mM borate, 2 mM EDTA, pH 8.3 gel (see Figure 21). The oligonucleotide (lane 2) was tailed with dTTP (lane 3) or dilutions of PBA-XX-dUTP in dTTP (lanes 4-7). The presence of PBA-XX-dUTP retarded the mobility of the tailed oligonucleotide (lanes 4-7) relative to the dTTP tailed oligonucleotide (lane 3).

(c) **Nick-translation**

The nick translation reaction was a modification of the reaction described by Rigby, *et al.*, *J. Mol. Biol.* 113:237-251 (1977), using PBA-XX-dUTP in place of dTTP. One microgram of DNA was suspended in 0.2 mM dATP, 0.2 mM dCTP, 0.2 mM dGTP, 5 0.2 mM PBA-XX-dUTP, 1X buffer (Boehringer Mannheim), and 1/10 volume DNAaseI/DNA polymerase mix (Boehringer Mannheim). The reaction was incubated for 90 min (15°C) and stopped by the addition of EDTA (50mM). Incorporation was verified by capture of probe on DHBHA Sepharose.

**EXAMPLE 3**

10 This example illustrates the preparation of magnetic particles having attached boronic acid binding moieties (or streptavidin) which are useful in the capture/detection methods described below. Additionally, the preparation of a coating protein having an attached boronic acid complexing moiety is also described. These coating proteins are also useful in purification methods as well as probe capture in microtiter plates.

15 3.1 *Preparation of SHA- and SA-magnetic particles*

(a) *Streptavidin-M280 bead preparation*

Dynal M280 unmodified beads (Oslo Norway, product 142.10; lot 3490; 100 mL) were concentrated to 40 mL in a 50 mL conical tube using a rare earth alloy magnet (Dynal, Oslo Norway). The beads were washed three times with water, and then dehydrated 20 into CH<sub>3</sub>CN (EM Science, Gibbstown, NJ) by incubating sequentially for five minutes in 40 mL of 25, 50, and 75% aqueous CH<sub>3</sub>CN. The beads were then washed three times with CH<sub>3</sub>CN, and once with dry dioxane (Aldrich Chemical Co., Milwaukee, WI). The beads were suspended in 40 mL dioxane containing 50 mg/mL of 1,1'-carbonyldiimidazole (Aldrich 25 Chemical Co., Milwaukee, WI) and rotated for one hour at room temperature. The beads were washed three times with CH<sub>3</sub>CN, and suspended in 5 mL of 10 mg/mL streptavidin (Prozyme, San Leandro, California, USA) in 0.1 M NaHCO<sub>3</sub>. A 5 mL aliquot of 1 M NaHCO<sub>3</sub> was added and the suspension was rotated for 5 hours at room temperature.

The beads were washed two times with 0.05% Tween 20® (polyoxyethylenesorbitan monolaurate, from Sigma Chemical Co., St. Louis, Missouri, USA) in 0.1 M NaHCO<sub>3</sub>, then extensively with 0.1 M NaHCO<sub>3</sub>, and suspended in 45 mL of 0.1 M NaHCO<sub>3</sub>. The final suspension was stored at 4°C.

5 (b) *SHA-M280 bead preparation*

Dynal M280 beads (142.10; lot 3490; 100 mL) were concentrated and washed 3 times with water and dehydrated into CH<sub>3</sub>CN as above. The beads were washed three times with 10 mL of CH<sub>3</sub>CN, once with 10 mL CH<sub>2</sub>Cl<sub>2</sub> (Aldrich Chemical Co.; Milwaukee, WI), and suspended in 18 mL CH<sub>2</sub>Cl<sub>2</sub> in a 50 mL conical tube. 2 mL DMSO (Aldrich  
10 Chemical Co., Milwaukee, WI) were added, and the beads chilled five minutes in a dry ice/isopropanol bath. Four 200  $\mu$ L aliquots of oxalyl chloride were added (Aldrich Chemical Co., Milwaukee, WI), and the reaction mixed occasionally during ten minutes in the dry ice bath. Triethylamine (Aldrich Chemical Co., Milwaukee, WI; 1000  $\mu$ L) was added, and the reaction mixed occasionally during five minutes in the ice bath and then five minutes at room  
15 temperature. The beads were washed three times with CH<sub>3</sub>CN, and rehydrated by reversing the dehydration procedure above, and washed once with water. The beads were then suspended in 36.4 mg SHA hydrazide (SHA-X-NH-NH<sub>2</sub>, lot rk02.43, fw = 346.8, 59  $\mu$ moles) dissolved in 400  $\mu$ L DMSO and diluted in 20 mL of 0.1 M NaOAc + 1 M NaCl pH 5.5. The bead reaction was rotated overnight at room temperature and washed  
20 extensively with water. The beads were suspended in 45 mL of water and stored in 5 mL aliquots at 4°C.

(c) *SHA-M450 bead preparation*

Dynal M450 beads (Dynal, Oslo Norway, 10 mL) were washed three times with water and dehydrated into CH<sub>3</sub>CN as described above. The beads were washed three  
25 times with 10 mL of CH<sub>3</sub>CN, once with 10 mL of CH<sub>2</sub>Cl<sub>2</sub>, and suspended in 9 mL of CH<sub>2</sub>Cl<sub>2</sub> plus 1 mL of DMSO. The were beads transferred to a 50 mL conical tube, and chilled for five minutes in a dry ice/isopropanol bath. Two 200  $\mu$ L aliquots of oxalyl chloride were added and the reaction was mixed occasionally during 10 minutes in the ice bath. Triethylamine (500  $\mu$ L) was added and the reaction was mixed occasionally during 5  
30 minutes in the ice bath and then 5 minutes at room temperature. CH<sub>3</sub>CN (10 mL) was added

to facilitate removal of the reaction mixture from the beads with a magnet. The beads were washed three times with  $\text{CH}_3\text{CN}$  and rehydrated into water by reversing the dehydration procedure. The beads were washed three times water, and suspended in 18.5 mg SHA-X-NHNH<sub>2</sub> dissolved in 125  $\mu\text{L}$  of DMSO and diluted in 5 mL of 0.1 M NaOAc + 0.1 M NaCl, pH 5.5. The bead reaction was rotated over night at room temperature, washed six times with water, and suspended in 10 mL of water. The beads were stored at 4°C.

### 3.2 Preparation of SHA-plate coating protein

#### (a) SHA-Antibody for plate coating

One vial of goat anti-mouse polyclonal antibody (Rockland, Gilbertsville, PA, product 210-1103) was dissolved in 5 mL of 0.1 M NaHCO<sub>3</sub> to produce a solution of 8.8 mg/mL as determined spectrophotometrically assuming 1 mg/mL antibody has an absorbance at 280 nm of 1.4 in a 1 cm cuvette. Two mL of the antibody solution, assumed to contain 118 nmoles of antibody, was conjugated with 2,350 nmoles of SA(OMe)-X-NHS (rk01.222; fw = 378), which was prepared by dissolving 1.6 mg of the NHS ester in 145  $\mu\text{L}$  DMSO, and adding 100  $\mu\text{L}$  of the solution to the antibody for one hour at room temperature.

The pH of the conjugation reaction was adjusted to 9.6 with 5  $\mu\text{L}$  of 10 N NaOH, and 2.1 mL of 2 M NH<sub>2</sub>OH, pH 10 were added. The reaction was incubated at room temperature for 3 days, and desalted on a 2.5 x 8 cm G-25 (Sigma Chemical Co., St. Louis, MO) in 50 mM NaHCO<sub>3</sub>. The protein fraction was collected and had a volume of 12 mL. The UV spectrum of the desalted conjugate was measured on a Hewlett Packard 8453 diode array spectrophotometer. The concentration of the conjugate was estimated by subtracting the  $A_{320}$  from the  $A_{280}$  to estimate the  $A_{280}$  from the antibody component of the conjugate. The conjugate concentration was estimated to be 1.75 mg/mL. The conjugate was stored at 4°C.

25

### EXAMPLE 4

This example illustrates the capture/detection of a polynucleotide in which one strand on the captured duplex is PBA-labeled and the complementary strand has an attached biotin.

#### 4.1 *Detection of PBA-labeled PCR product bound to SHA-magnetic particles*

PBA-labeled PCR product (0.02  $\mu$ L - 5  $\mu$ L) was diluted into 25-100  $\mu$ L of 1.5 N NaCl, 150 mM sodium citrate, pH 7 and added to a polypropylene microtiter plate well containing SHA-magnetic particles (10-50  $\mu$ L). The particles and PCR product were mixed well and the binding occurred at room temperature (30-60 min). The magnetic particles were drawn to a magnetic plate and washed five times in 150 mM NaCl, 20 mM Tris-HCl, 0.02% Tween 20<sup>®</sup>, pH 8. One hundred microliters of streptavidin alkaline-phosphatase (0.2U/mL in 1 mg/mL BSA, NaCl, Tris-HCl, pH 8; Boehringer Mannheim, Indianapolis, Indiana, USA) or streptavidin-horseradish peroxidase (0.1U/mL in 1 mg/mL BSA, NaCl, Tris-HCl, pH 8, Boehringer Mannheim) were added and mixed well with the magnetic particles. After 30 min (room temperature) the magnetic particles were drawn to a magnetic plate and washed 5-7 times in 150 mM NaCl, 20 mM Tris-HCl, 0.02% Tween 20<sup>®</sup>, pH 8. Substrate was added for alkaline phosphatase (1 mg/mL *para*-nitrophenylphosphate in 1 M diethanolamine, 2 mM MgCl<sub>2</sub>, 0.2 mM ZnCl<sub>2</sub>, pH 10.4) or horseradish peroxidase (ABTS 1-Step<sup>™</sup> Pierce Chemical Co.). Substrate development (37°C) occurred for 10-60 min. One microliter or less of PCR product ( $\geq$  50pg) could be detected.

#### 4.2 *Detection of PBA-labeled PCR product bound to SHA-coated microtiter plates*

Polystyrene microtiter plates (Falcon, Becton Dickinson, Baltimore, Maryland, USA) were coated by filling wells with 200  $\mu$ L of SHA-plate coating protein (30  $\mu$ L/mL in 0.1 M NaHCO<sub>3</sub>, pH 9.0) and incubated overnight (4°C) or incubated for 60 min (37°C). The plate was washed 5 times with 150 mM NaCl, 20 mM Tris-HCl, 0.02% Tween 20<sup>®</sup>, pH 8 and backcoated with BSA (5 mg/mL in 0.2 M NaHCO<sub>3</sub> pH 9.0) for 1.5 h (RT). The plate was washed 5 times with 150 mM NaCl, 20 mM Tris-HCl, 0.02% Tween 20<sup>®</sup>, pH 8. PBA-labeled PCR product (0.02  $\mu$ L - 5  $\mu$ L was diluted into 25-100  $\mu$ L of 1.5 N NaCl, 150 mM sodium citrate, pH 7, was added to the SHA coated microtiter plate, and bound (RT; 30-60 min). The plate was washed five times in 150 mM NaCl, 20 mM Tris-HCl, 0.02% Tween 20<sup>®</sup>, pH 8. One hundred microliters of streptavidin alkaline-phosphatase (0.2 U/mL in 1 mg/mL BSA, NaCl, Tris-HCl, pH 8; Boehringer Mannheim) or strepavidin-horseradish

peroxidase (0.1 U/mL in 1 mg/mL BSA, NaCl, Tris-HCl, pH 8, Boehringer Mannheim) were added. After 30 min (room temperature) the plate was washed 5-7 times in 150 mM NaCl, 20 mM Tris-HCl, 0.02% Tween 20®, pH 8. Substrate was added for alkaline phosphatase (1 mg/mL para-nitrophenyl phosphate in 1 M diethanolamine, 2 mM MgCl<sub>2</sub>, 0.2 mM ZnCl<sub>2</sub>, pH 10.4) or horseradish peroxidase (ABTS I-StepT™, Pierce Chemical Co.). Substrate development (37° C) occurs for 10-60 min. One microliter or less of PCR product ( $\geq 1.5$  ng) could be detected.

### EXAMPLE 5

This example illustrates the detection of PBA-labeled nucleic acid with SHA-labeled enzymes.

#### *5.1 DHBHA Conjugation of Alkaline Phosphatase*

One milliliter of alkaline phosphatase (6 mg/mL, Sigma, P-6774; from bovine intestine) was dialyzed against one liter of 0.1 M NaHCO<sub>3</sub>, and conjugated with 714 nmoles of DHBA(OMe)-X-NHS (10.5  $\mu$ L of 68 mM in DMF) for two hours on ice. The methyl ester of the conjugate was converted to a hydroxamic acid by the adding one milliliter of 2 M NH<sub>2</sub>OH pH 10, and incubating the mixture at 4° C for six days. The NH<sub>2</sub>OH reaction mixture was then dialyzed against 0.1 M NaHCO<sub>3</sub> and stored at 4° C.

#### *5.2 SHA Conjugation of Alkaline Phosphatase*

One milliliter of alkaline phosphatase (6.9 mg/mL, Sigma, P-6774; from bovine intestine) was dialyzed against one liter of 0.1 M NaHCO<sub>3</sub>, and conjugated with 668 nmoles of SA(OMe)-X-NHS (11.7  $\mu$ L of 57 mM in DMF) for two hours on ice. The methyl ester of the conjugate was converted to a hydroxamic acid by adding one milliliter of 2 M NH<sub>2</sub>OH pH 10, adjusting the pH to 10 with 1 N NaOH, and incubating the mixture at 4° C for seven days. The NH<sub>2</sub>OH reaction mixture was then dialyzed against 0.1 M NaHCO<sub>3</sub> and stored at 4° C.



### 5.3 *Detection of PBA-labeled polynucleotide hybrids bound to streptavidin-magnetic beads with SHA-enzymes*

Polynucleotide PBA-7172 and biotin-complement 6371 were hybridized to opposite ends of a complementary 42mer in 1.5 N NaCl, 150 mM sodium citrate, pH 7 for 10 min (RT) and cooled. The hybrid sandwich was added to a polypropylene microtiter plate well containing SHA-M450 magnetic particles (10-50  $\mu$ L). The particles and hybrid sandwich were mixed well and the binding occurred at room temperature or 45°C (30-60 min). The magnetic particles were drawn to a magnetic plate and washed five times in 150 mM NaCl, 20 mM Tris-HCl, 0.02% Tween 20®, pH 8. One hundred microliters of SHA-alkaline-phosphatase (1  $\mu$ g/mL in 1 mg/mL BSA, NaCl, Tris-HCl, pH 8; Boehringer Mannheim) or SHA-horseradish peroxidase (1  $\mu$ g/mL in 1 mg/mL BSA, NaCl, Tris-HCl, pH 8, Boehringer Mannheim) were added and mixed well with the magnetic particles. After 30 min (room temperature) the magnetic particles were drawn to a magnetic plate and washed 5-7 times in 150 mM NaCl, 20 mM Tris-HCl, 0.02% Tween 20®, pH 8. Substrate was added for alkaline phosphatase (1 mg/mL para-nitrophenyl phosphate in 1 M diethanolamine; 2 mM MgCl<sub>2</sub>, 0.2 mM ZnCl<sub>2</sub>, pH 10.4) or horseradish peroxidase (ABTS 1-Step™, Pierce Chemical Co.). Substrate development (37°C) occurred for 10-60 min. Forty-five picograms or greater of 42mer could be detected.

### 5.4 *Detection of PBA-labeled polynucleotide hybrids bound to streptavidin-coated microtiter plates*

Polystyrene microtiter plates (Falcon, Becton Dickinson) were coated by filling wells with 200  $\mu$ L of Streptavidin-Plus-(30  $\mu$ g/mL in 0.1 M NaHCO<sub>3</sub> pH 9.0; Prozyme) and incubated overnight (4°C) or incubated 60 min (37°C). The plate was washed 5 times with 150 mM NaCl, 20 mM Tris-HCl, 0.02% Tween 20®, pH 8 and backcoated with BSA (5 mg/mL in 0.2 M NaHCO<sub>3</sub> pH 9.0) for 1.5 h (RT). The plate was washed 5 times with 150 mM NaCl, 20 mM Tris-HCl, 0.02% Tween 20®, pH 8. Polynucleotide PBA-7172 and biotin-complement 6371 were hybridized to a complementary 42mer in 1.5 N NaCl, 150 mM sodium citrate, pH 7 for 10 min (RT) and cooled. The hybrid sandwich was added to the streptavidin-coated microtiter plate, and bound (RT; 30-60 min). The plate was washed five times in 150 mM NaCl, 20 mM Tris-HCl, 0.02% Tween 20®, pH 8. One hundred

microliters of SHA-alkaline-phosphatase (1  $\mu\text{g}/\text{mL}$  in 1 mg/mL BSA, NaCl, Tris-HCl, pH 8; Boehringer Mannheim) or SHA-horseradish peroxidase (1  $\mu\text{g}/\text{mL}$  in 1 mg/mL BSA, NaCl, Tris-HCl, pH 8, Boehringer Mannheim) were added. After 30 min (RT) the plate was washed 5-7 times in 150 mM NaCl, 20 mM Tris-HCl, 0.02% Tween 20<sup>®</sup>, pH 8. Substrate was added for alkaline phosphatase (1 mg/mL para-nitrophenyl phosphate in 1 M diethanolamine, 2 mM  $\text{MgCl}_2$ , 0.2 mM  $\text{ZnCl}_2$ , pH 10.4) or horseradish peroxidase (ABTS 1-Step<sup>™</sup>, Pierce Chemical Co.). Substrate development (37°C) occurred for 10-60 min.

### 5.5 *Detection of PBA-probe-SHA-alkaline phosphatase hybridized to nucleic acid immobilized on membranes*

PCR product (801 bp) or pBR322 DNA was denatured by adding NaOH to 0.56 N (10 min, RT). The sample was mixed with an equal volume of 2 M ammonium acetate, applied to a Nytran membrane (Schleicher and Scheull), and baked at 80°C for 1-24 h or UV-irradiated for 60 sec. The membrane was wetted in 150 mM NaCl, 20 mM Tris-HCl, 0.02% Tween 20<sup>®</sup>, pH 8 and blocked in a blocking solution (Boehringer Mannheim) for 1 h (RT) or overnight (4°C). The blocking solution was removed.

Fifty nanograms of PBA-oligo or denatured PBA-labeled probe were mixed with 5.3-26.5  $\mu\text{g}$  of SHA-alkaline phosphatase and incubated (10 min, RT). Conjugate diluent (0.5 mg/mL BSA in 150 mM NaCl, 20 mM Tris-HCl, 0.02% Tween 20<sup>®</sup>, pH 8) was added to the probe-enzyme mixture to 1 mL (1 min, RT). The mixture was added to the blocked membrane that was in 9 mL of hybridization solution (1 M NaCl, 20 mM Tris-HCl pH 7.5, 1 mM EDTA, 0.05% Tween20). The hybridization was performed for one hr to overnight (RT-37°C). The membrane was washed five-seven times in 150 mM NaCl, 20 mM Tris-HCl, 0.02% Tween 20<sup>®</sup>, pH 8 and substrate solution (103 mM nitro blue tetrazolium, 759 mM 5-bromo-4-chloro-3-indoyl-phosphate, 0.1 M Tris-HCl pH 9.0., 0.1 M NaCl, 50 mM  $\text{MgCl}_2$ ) was added. Color development occurred in the dark for 1-16 h. As few as 4 pg of DNA could be detected, depending upon type of probe, concentration of probe, hybridization time, and substrate incubation time.

The above description is illustrative and not restrictive. Many variations of the invention will become apparent to those of skill in the art upon review of this disclosure. The scope of the invention should, therefore, be determined not with reference to the above description, but instead should be determined with reference to the appended claims along  
5 with their full scope of equivalents.

WHAT IS CLAIMED IS:

1. A compound having the formula:

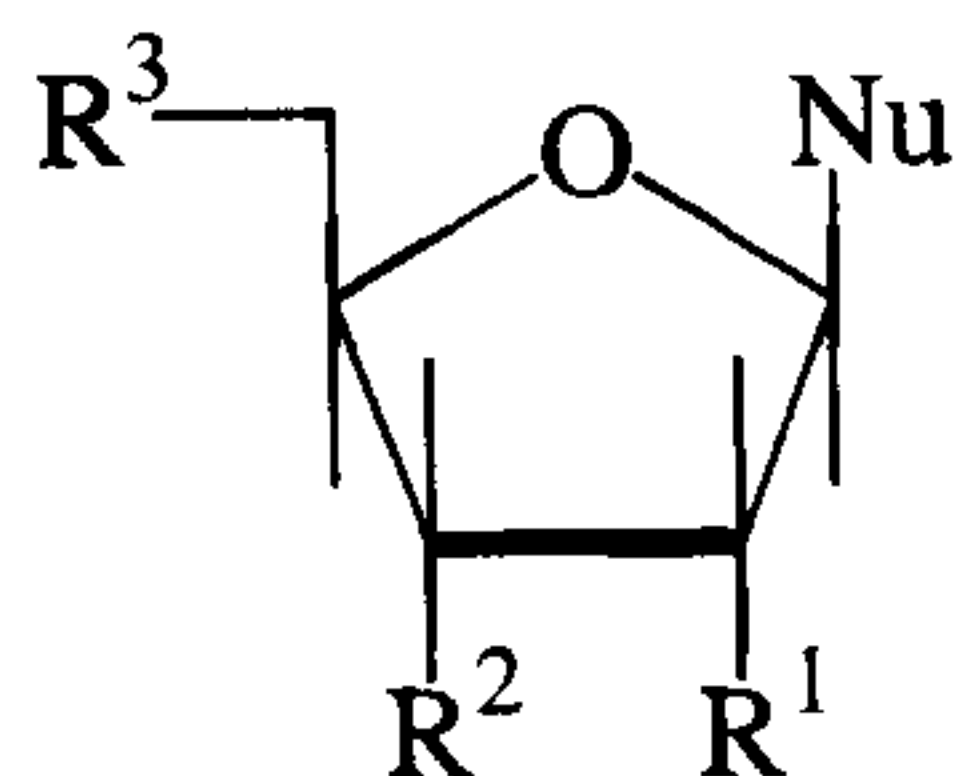

wherein:

$R^1$ ,  $R^2$  and  $R^3$  are each members independently selected from the group consisting of hydrogen, hydroxyl, protected hydroxyl, monophosphate ester, diphosphate ester, and triphosphate ester;

Nu is a radical selected from the group consisting of

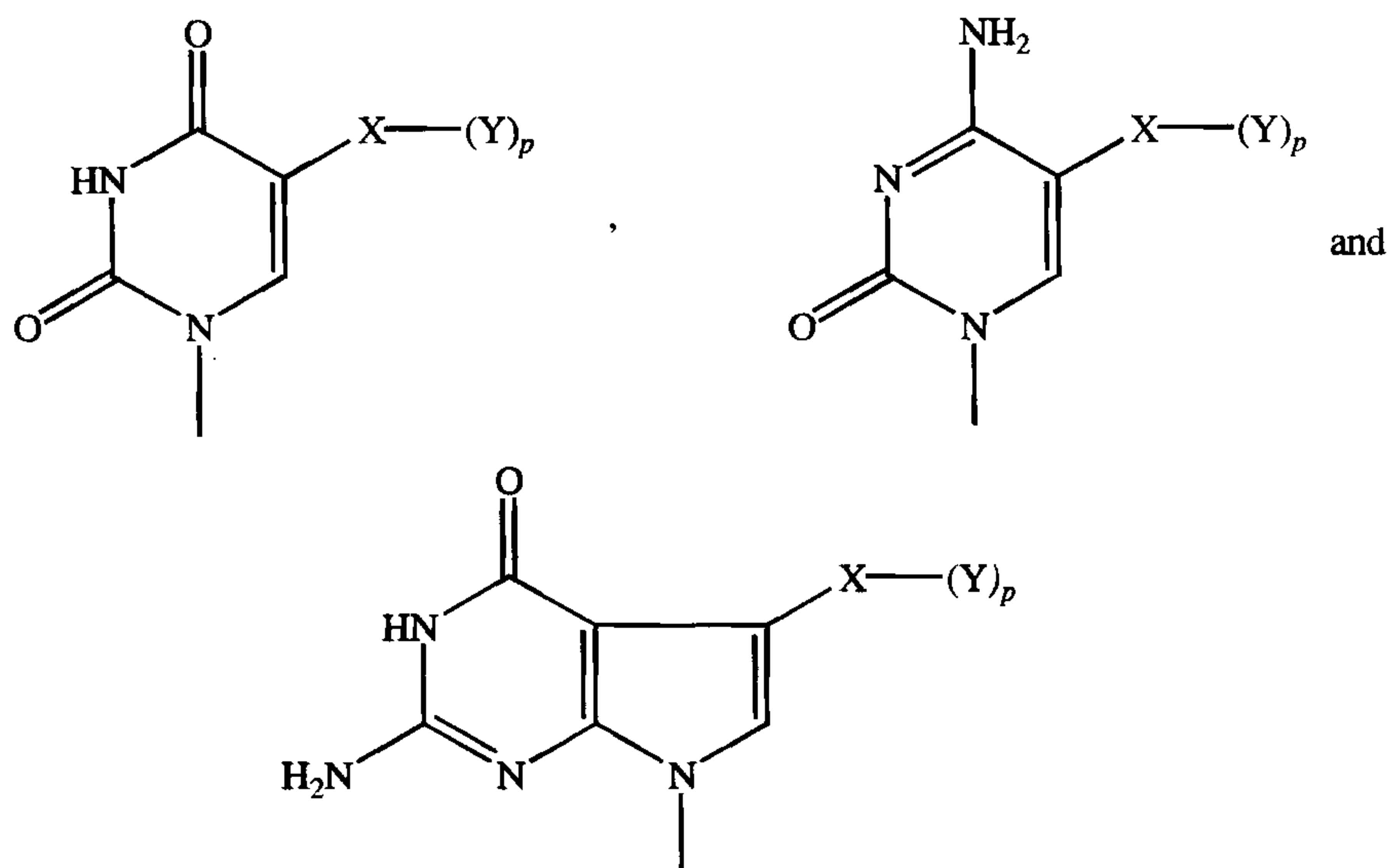

wherein:

X is a linking group comprising of from 7 to 30 carbon atoms, a portion of which is an aromatic ring; and

Y is a member selected from the group consisting of  $-B(OH)_2$ ,  $-B(OH)(OR)$  and  $-B(OR)(OR')$ , wherein R and R' are each independently lower alkyl groups having from one to six carbon atoms; and

p is an integer of from 1 to 3.

2. A compound having the formula:

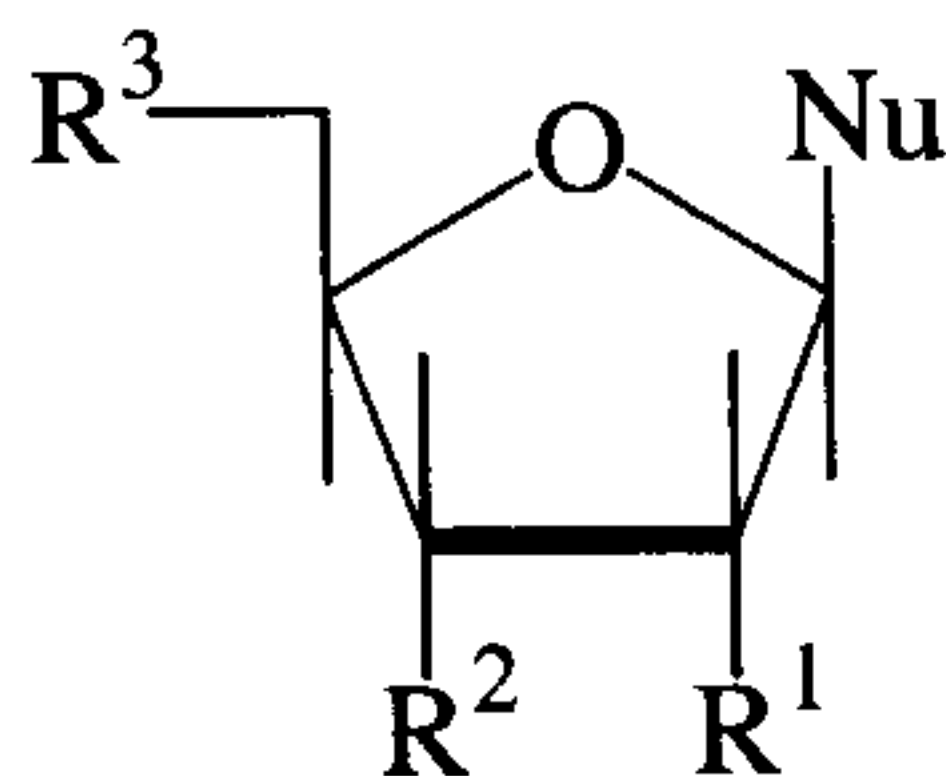

wherein

$R^1$ ,  $R^2$  and  $R^3$  are each members independently selected from the group consisting of hydrogen, hydroxyl, protected hydroxyl, monophosphate ester, diphosphate ester, and triphosphate ester;

Nu is a radical selected from the group consisting of

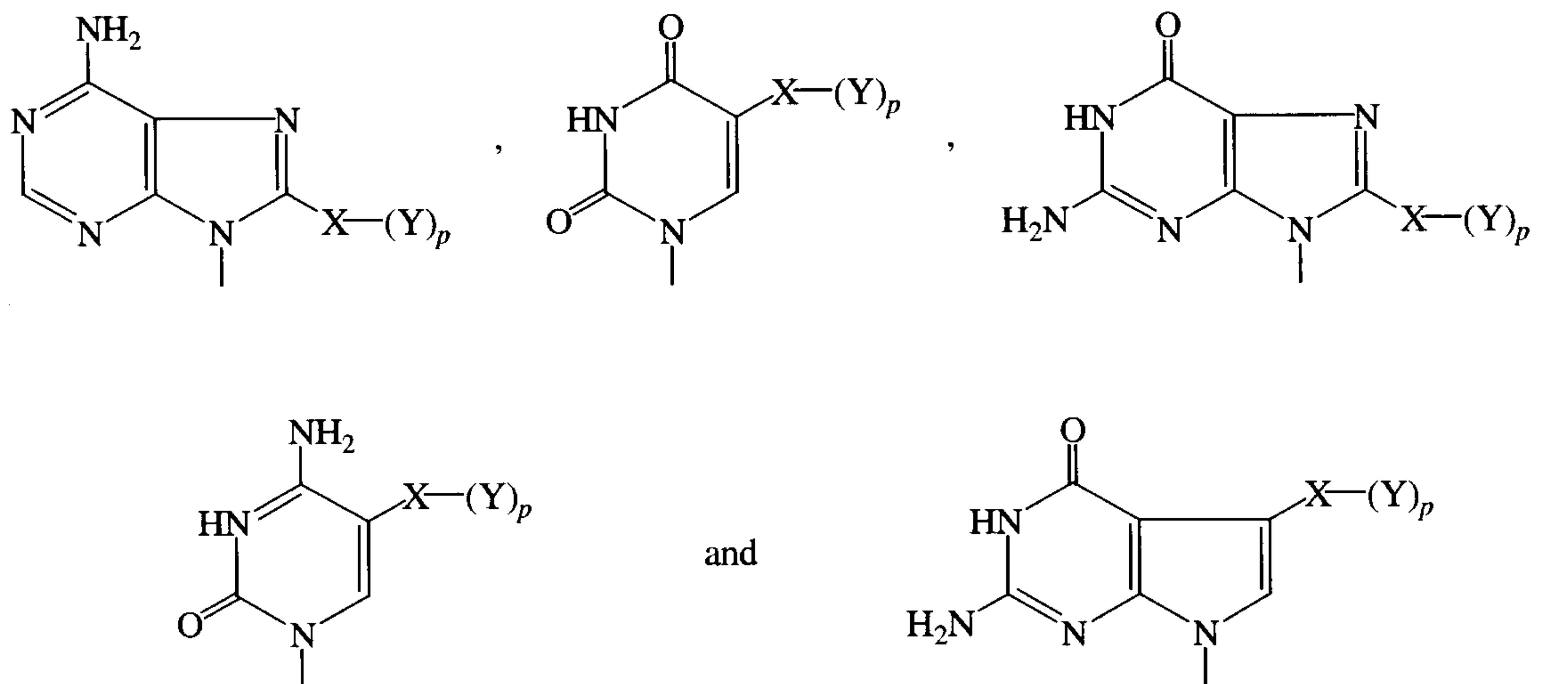

wherein:

$p$  is an integer of from 1 to 3, and  $-X-$  and  $-(Y)_p$  taken together comprise a radical selected from the group consisting of

48

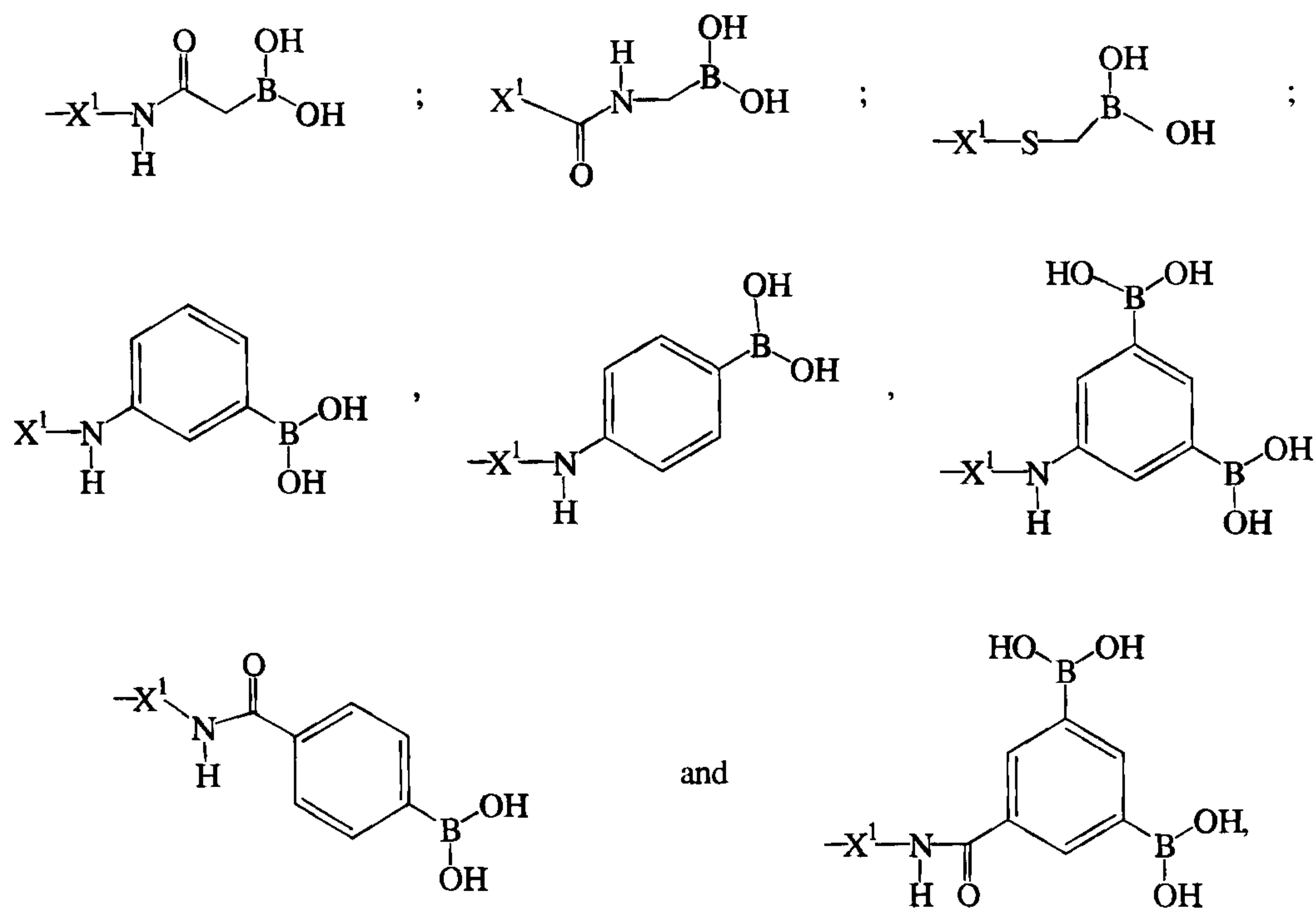

in which  $X^1$  is a linking group fragment comprising of from 3 to 23 carbon atoms.

3. A compound having the formula:

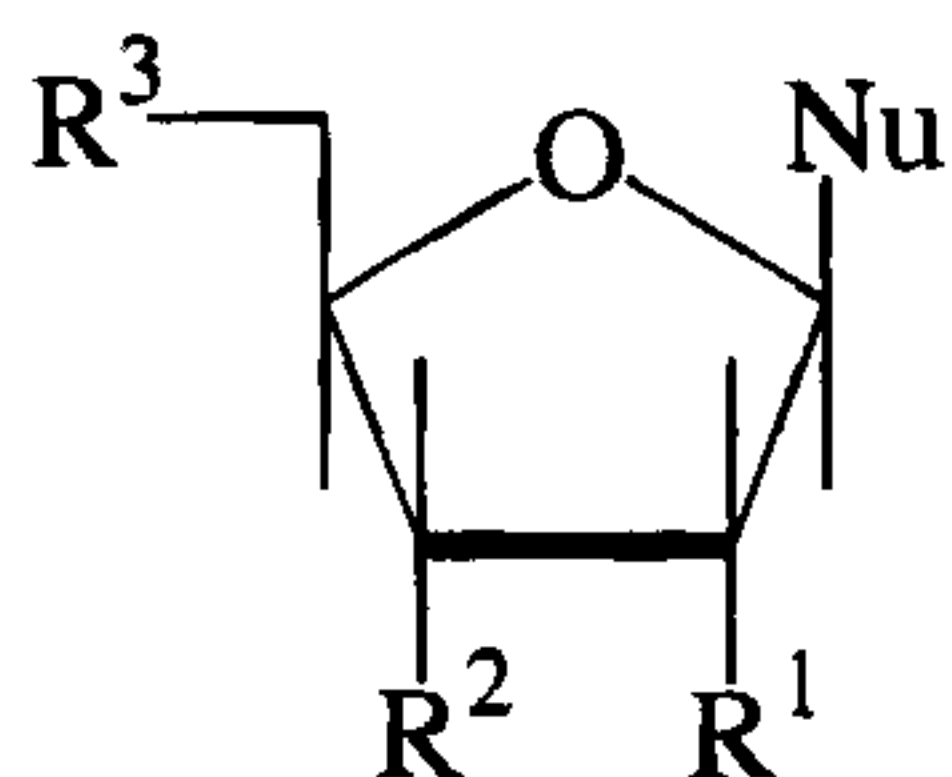

wherein

$R^1$ ,  $R^2$  and  $R^3$  are each members independently selected from the group consisting of hydrogen, hydroxyl, protected hydroxyl, monophosphate ester, diphosphate ester, and triphosphate ester;

$Nu$  is a radical selected from the group consisting of

49

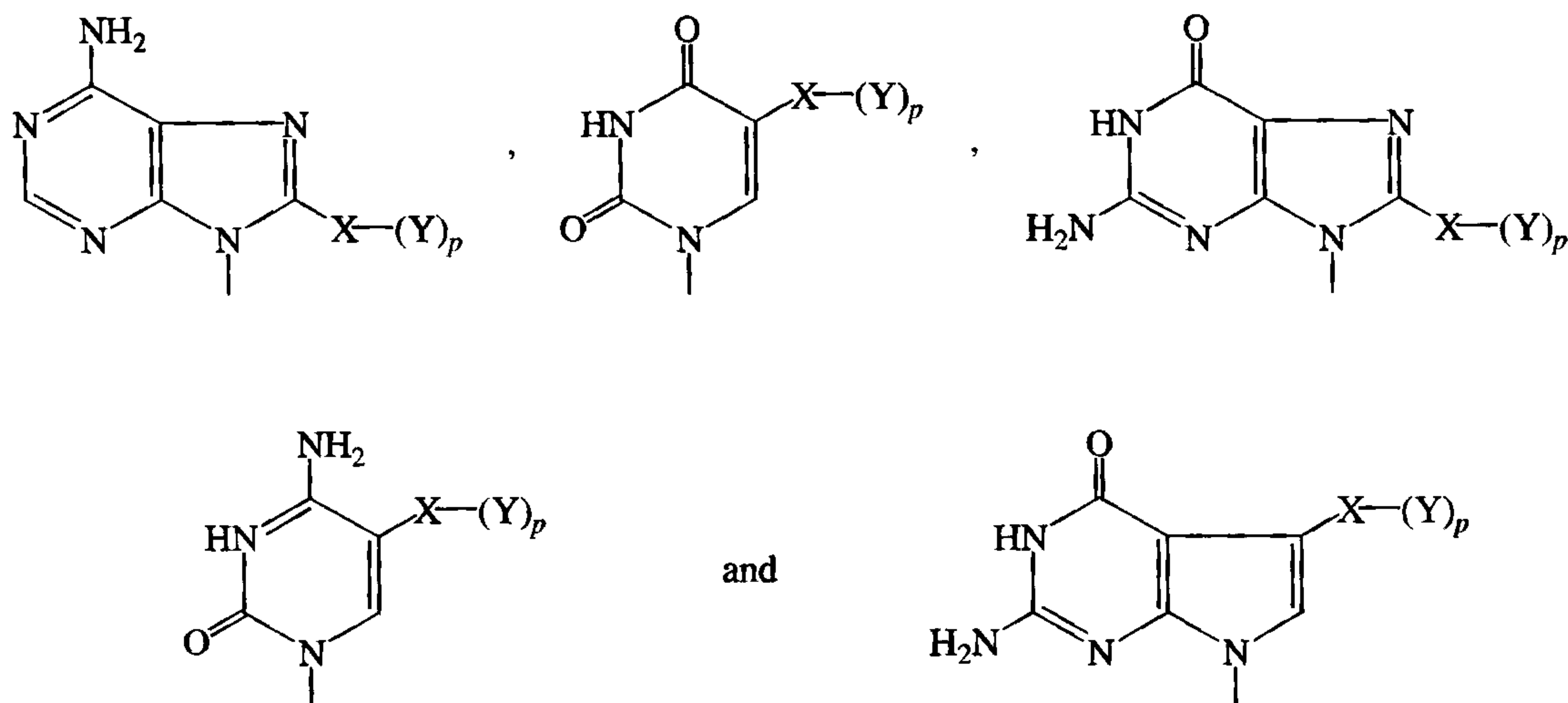

wherein:

X is a linking group comprising of from 7 to 30 carbon atoms, a portion of which is an aromatic ring, and further comprising a diradical  $-\text{CH}=\text{CH}-$  attached directly to the heterocyclic portion of said Nu; and

Y is a member selected from the group consisting of  $-\text{B}(\text{OH})_2$ ,  $-\text{B}(\text{OH})(\text{OR})$  and  $-\text{B}(\text{OR})(\text{OR}')$ , wherein R and R' are each independently lower alkyl groups having from one to six carbon atoms; and

p is an integer of from 1 to 3.

4. A compound in accordance with claim 2, wherein  $-\text{X}-$  and  $-(\text{Y})_p$  taken together comprise a radical selected from the group consisting of

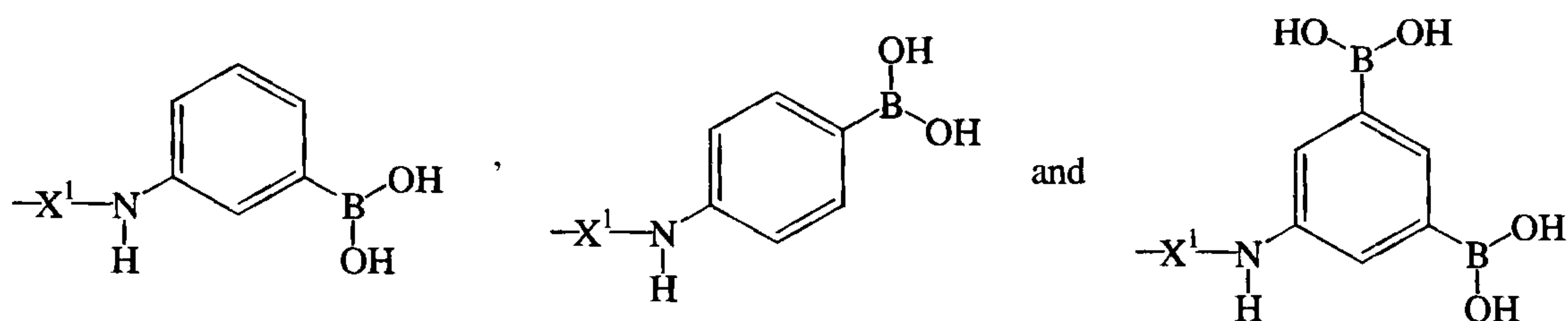

in which  $\text{X}^1$  is a linking group fragment comprising of from 3 to 23 carbon atoms.

5. A compound in accordance with claim 3, wherein X is a member selected from the group consisting of  $-\text{CH}=\text{CH}-\text{CH}_2-\text{NHCOAr}-$ ,  $-\text{CH}=\text{CH}-\text{CH}_2-\text{NHAr}-$ ,  $-\text{CH}=\text{CH}-\text{CH}_2-\text{O}-\text{Ar}-$ ,  $-\text{CH}=\text{CH}-\text{CONH}-\text{Ar}-$ ,  $-\text{CH}=\text{CH}-\text{CH}_2-\text{CONH}-\text{Ar}-$ ,  $-\text{CH}=\text{CH}-\text{CH}_2-\text{NHCO}-(\text{CH}_2)_n-\text{NHCO}-\text{Ar}-$ , and  $-\text{CH}=\text{CH}-\text{CH}_2-\text{NHCO}-(\text{CH}_2)_n-\text{NHCO}-(\text{CH}_2)_m-\text{CONH}-\text{Ar}-$  wherein Ar represents a divalent aromatic ring selected from the group consisting of phenyl and naphthyl and n and m independently represent integers of from 1 to 6.

6. A compound in accordance with claim 1, 3, or 5, wherein Y is  $-\text{B}(\text{OH})_2$ .

7. A compound in accordance with claim 3, wherein X is

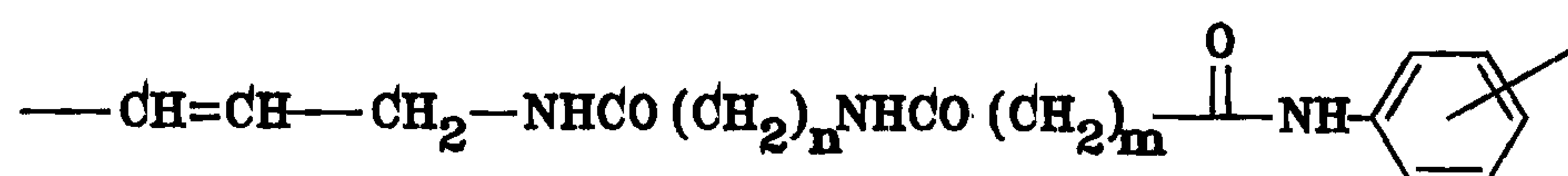

wherein n and m independently represent integers of from 1 to 6, Y is  $-\text{B}(\text{OH})_2$  and p is 1 or 2.

8. A compound in accordance with claim 3 having the formula:

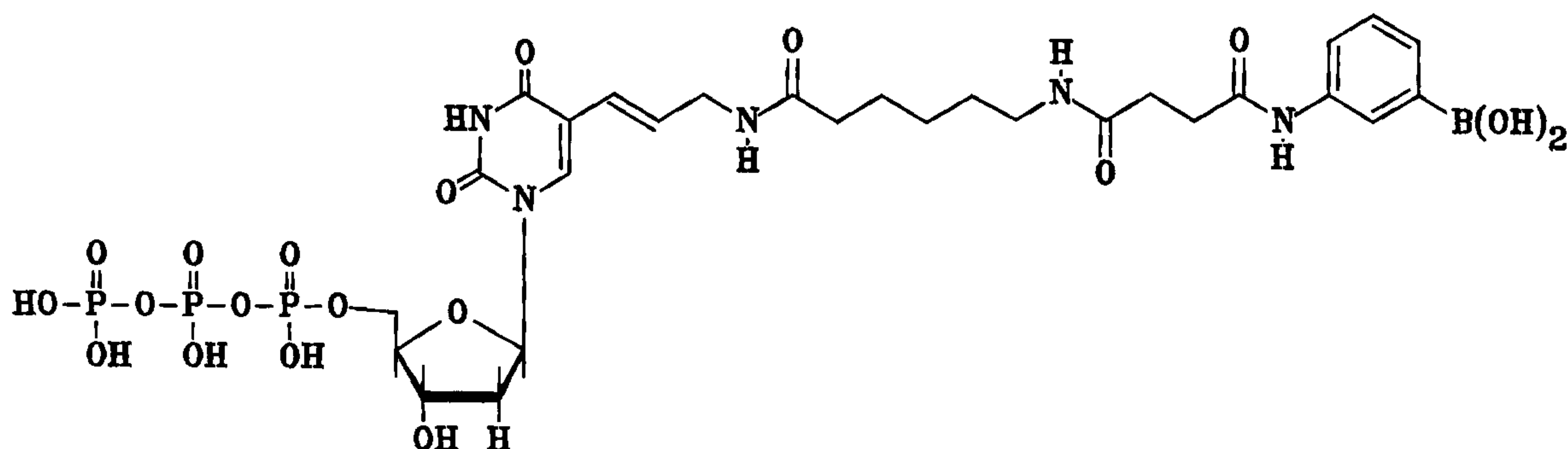



## 9. A modified polynucleotide having the formula:

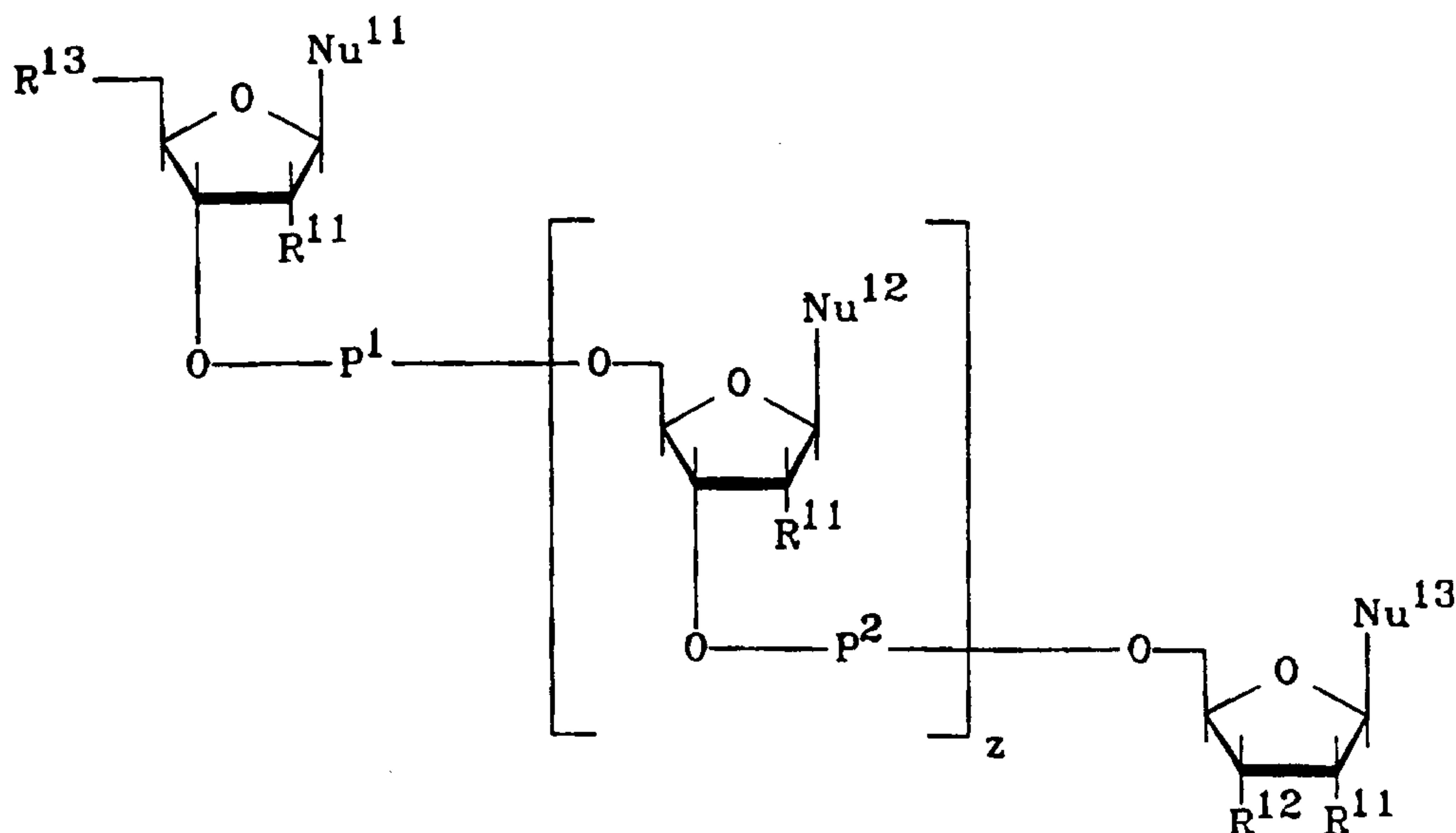

wherein

$z$  is an integer of from 1 to 1000;

each  $R^{11}$  is independently selected from the group consisting of  $-H$  and  $-OH$ ;

$R^{12}$  and  $R^{13}$  are each members independently selected from the group consisting of hydroxyl, protected hydroxyl, monophosphate ester, diphosphate ester and triphosphate ester;

each  $P^1$  and  $P^2$  is independently selected from the group consisting of  $-P(O)(OH)-$ ,  $-P(O)(NH_2)-$ ,  $-P(S)(OH)-$ ,  $-P(O)(CH_3)-$ , and pharmaceutically acceptable salts thereof;

each  $Nu^{11}$ ,  $Nu^{12}$  and  $Nu^{13}$  is independently selected from the group consisting of

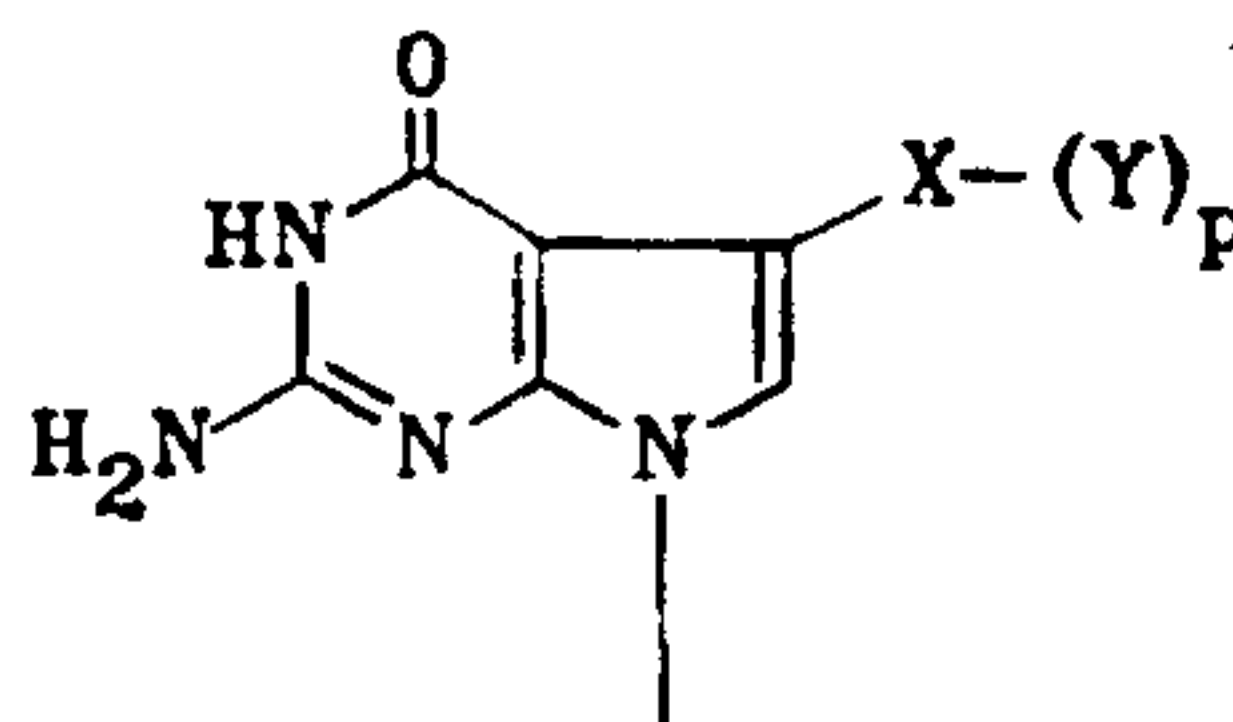
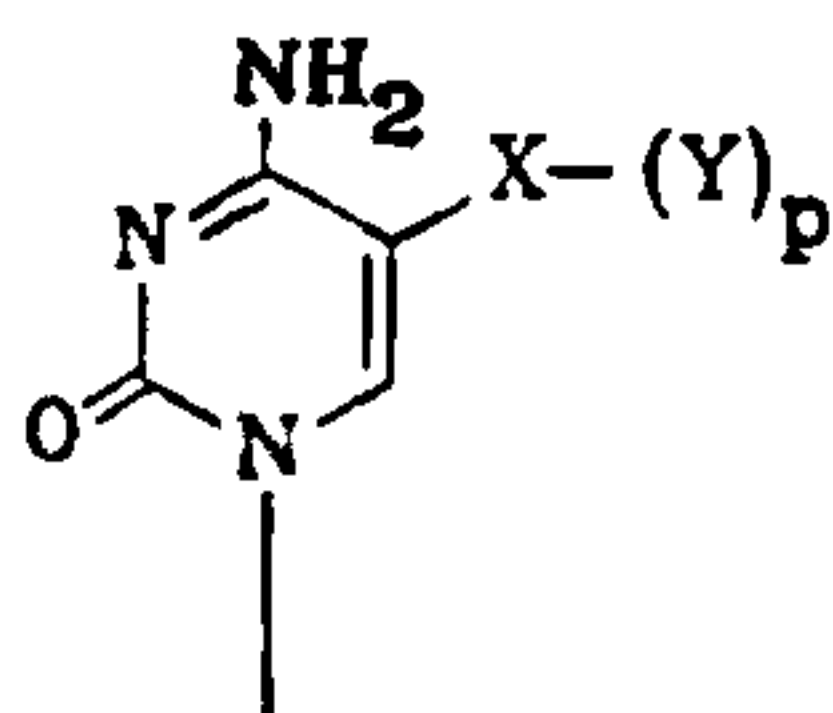
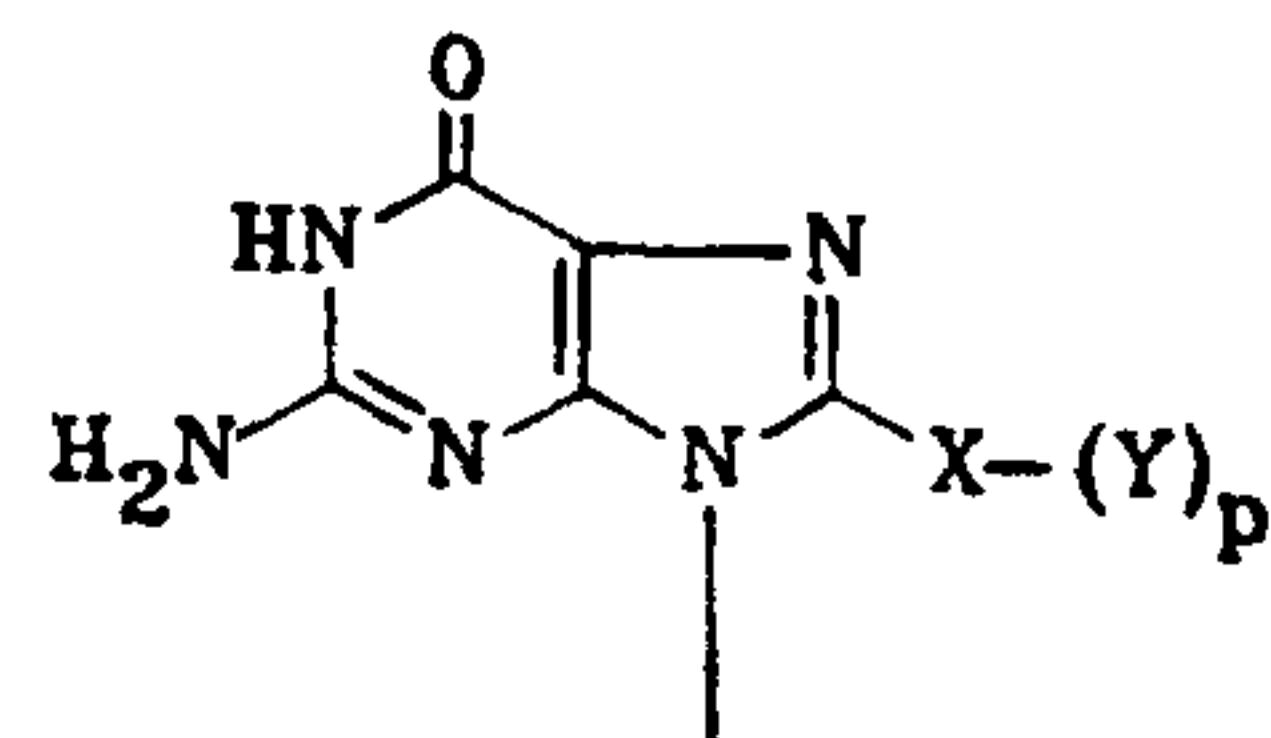
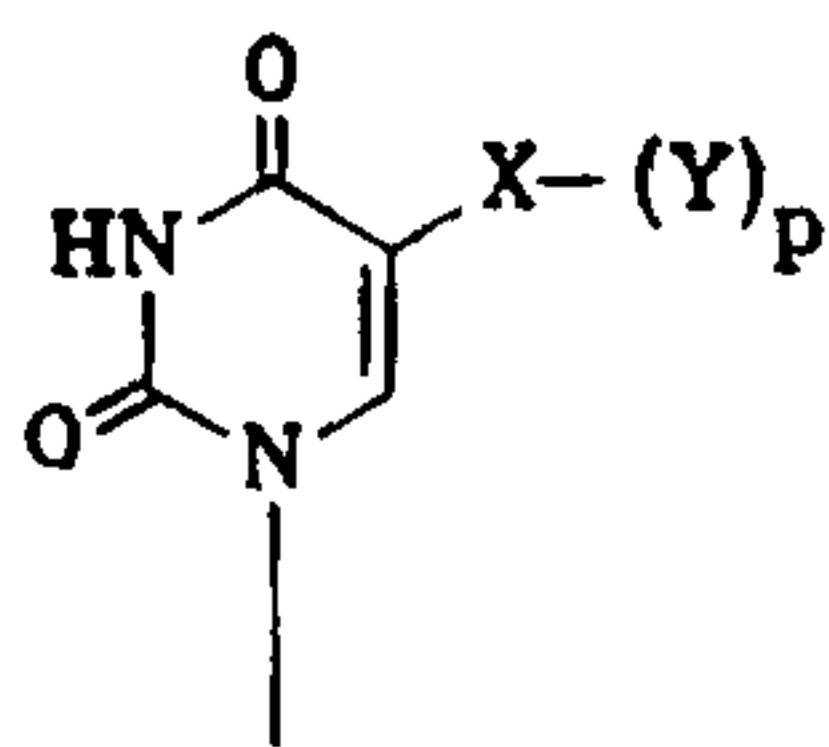
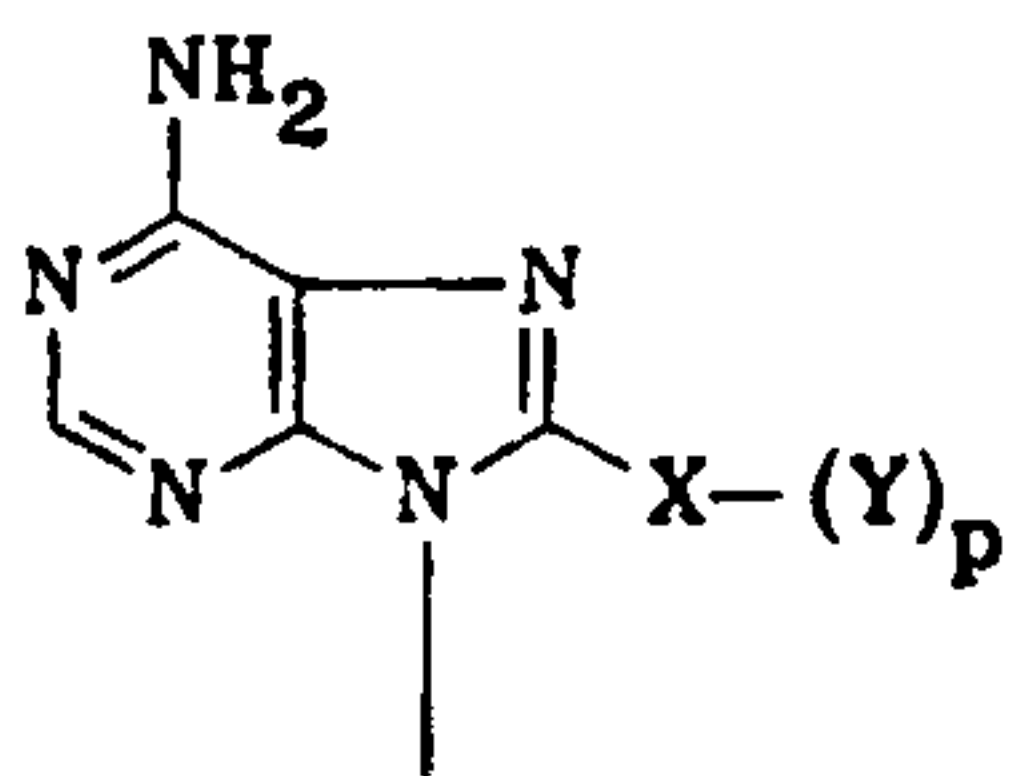

adenine, guanine, thymine and cytosine,

wherein

X is a linking group comprising of from 7 to 30 carbon atoms, a portion of which is an aromatic ring; and

Y is a member selected from the group consisting of  $-\text{B}(\text{OH})_2$ ,  $-\text{B}(\text{OH})(\text{OR})$  and  $-\text{B}(\text{OR})(\text{OR}')$ , wherein R and R' are each independently lower alkyl groups having from one to six carbon atoms; and

p is an integer of from 1 to 3;

with the proviso that at least one and no more than thirty of  $\text{Nu}^{11}$ ,  $\text{Nu}^{12}$  and  $\text{Nu}^{13}$  are other than adenine, guanine, thymine or cytosine.

10. A modified polynucleotide in accordance with claim 9, wherein  $\text{R}^{12}$  is hydroxyl and  $\text{R}^{13}$  is a monophosphate ester.

11. A modified polynucleotide in accordance with claim 9 or 10, wherein z is an integer of from about 5 to about 100.

12. A modified polynucleotide in accordance with claim 9 or 10, wherein z is an integer of from about 10 to about 30.

13. A modified polynucleotide in accordance with claim 9, 10, 11 or 12, wherein one of  $\text{Nu}^{11}$ ,  $\text{Nu}^{12}$  or  $\text{Nu}^{13}$  is a member selected from the group consisting of

53

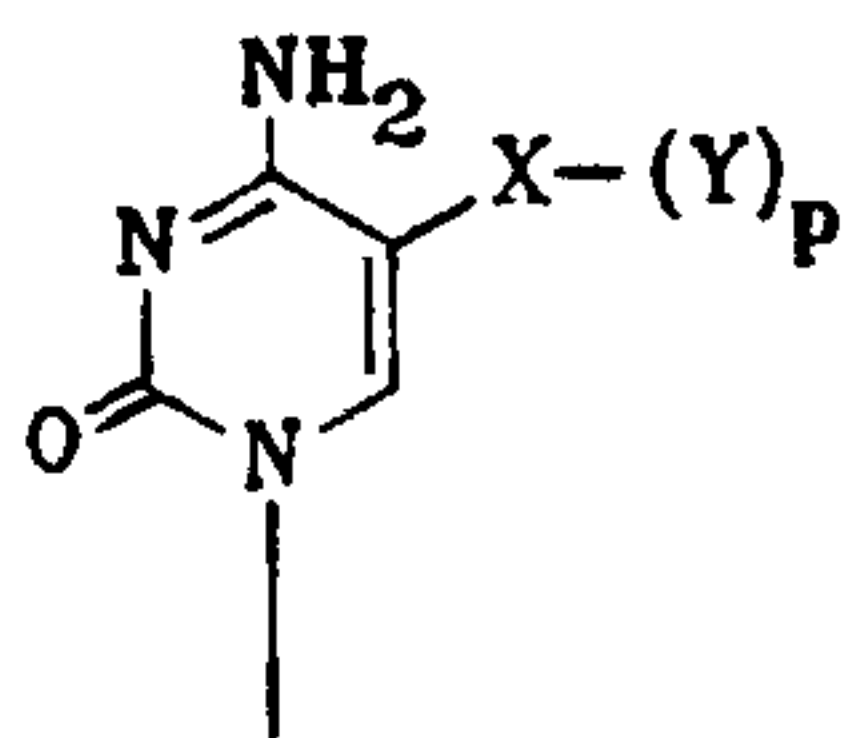
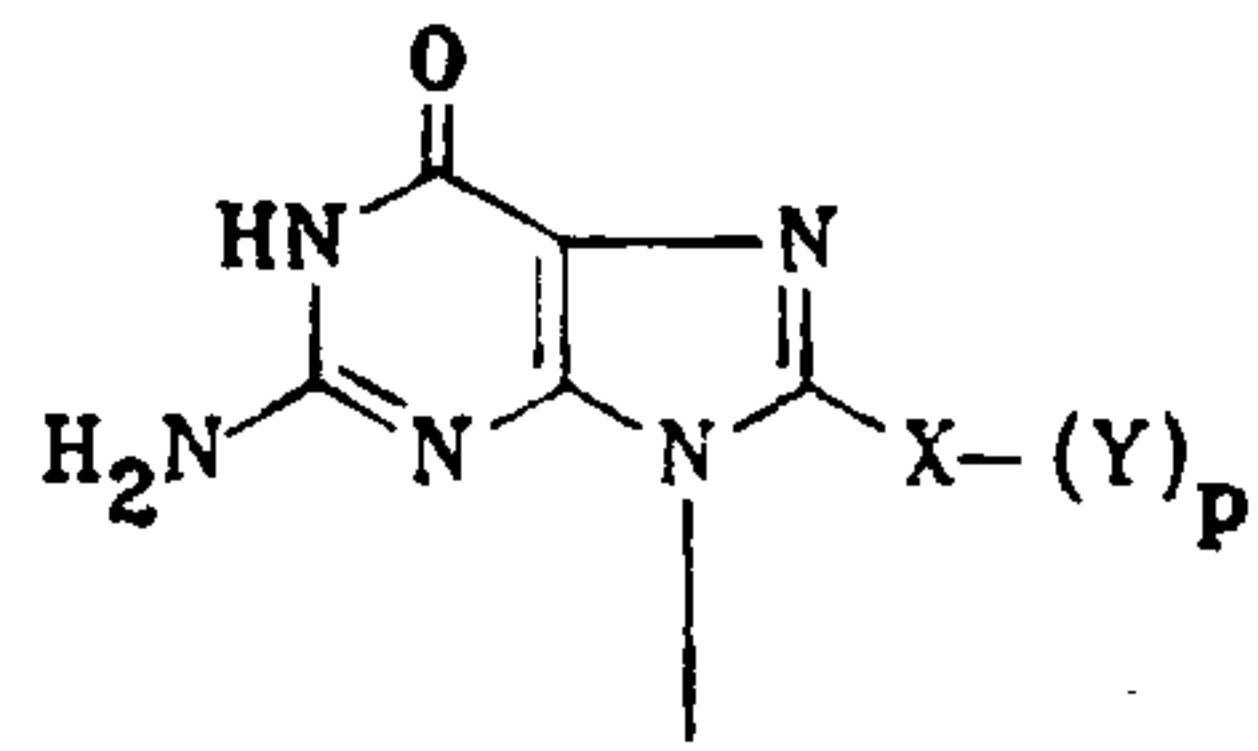
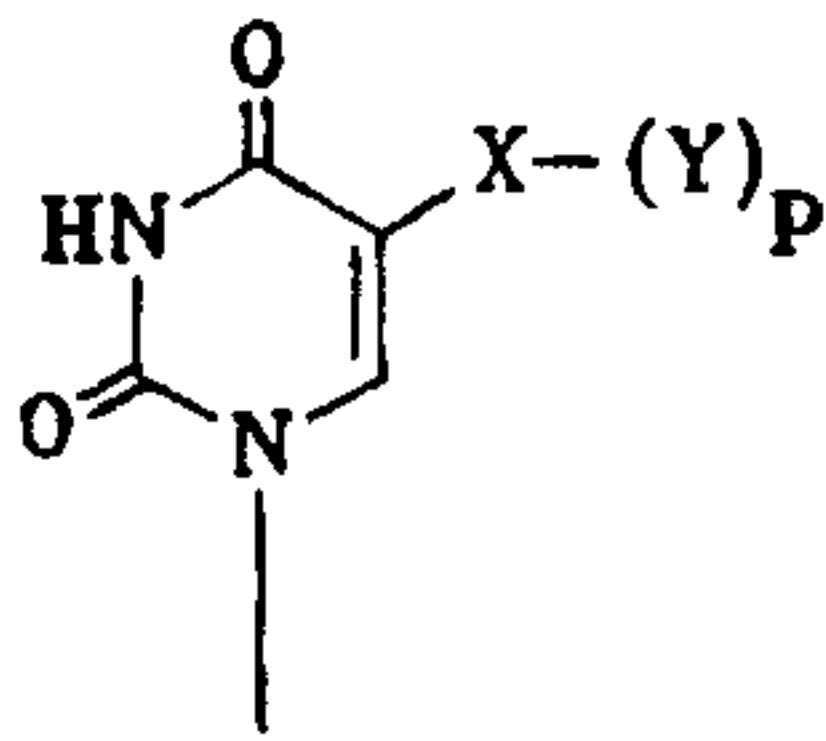
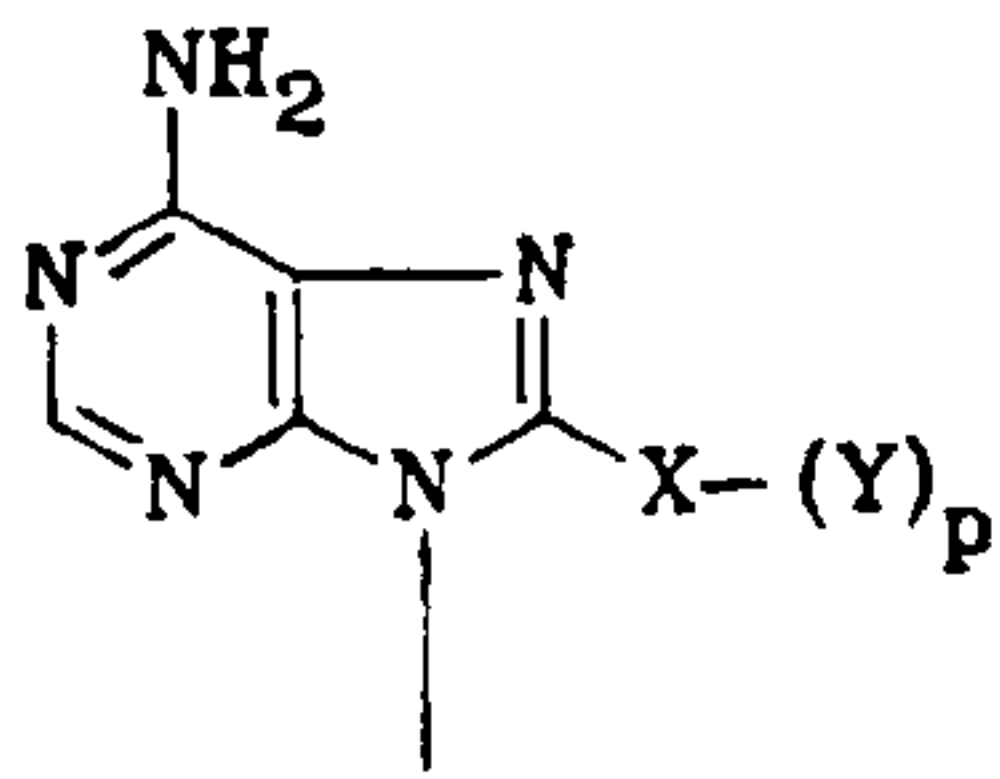

and

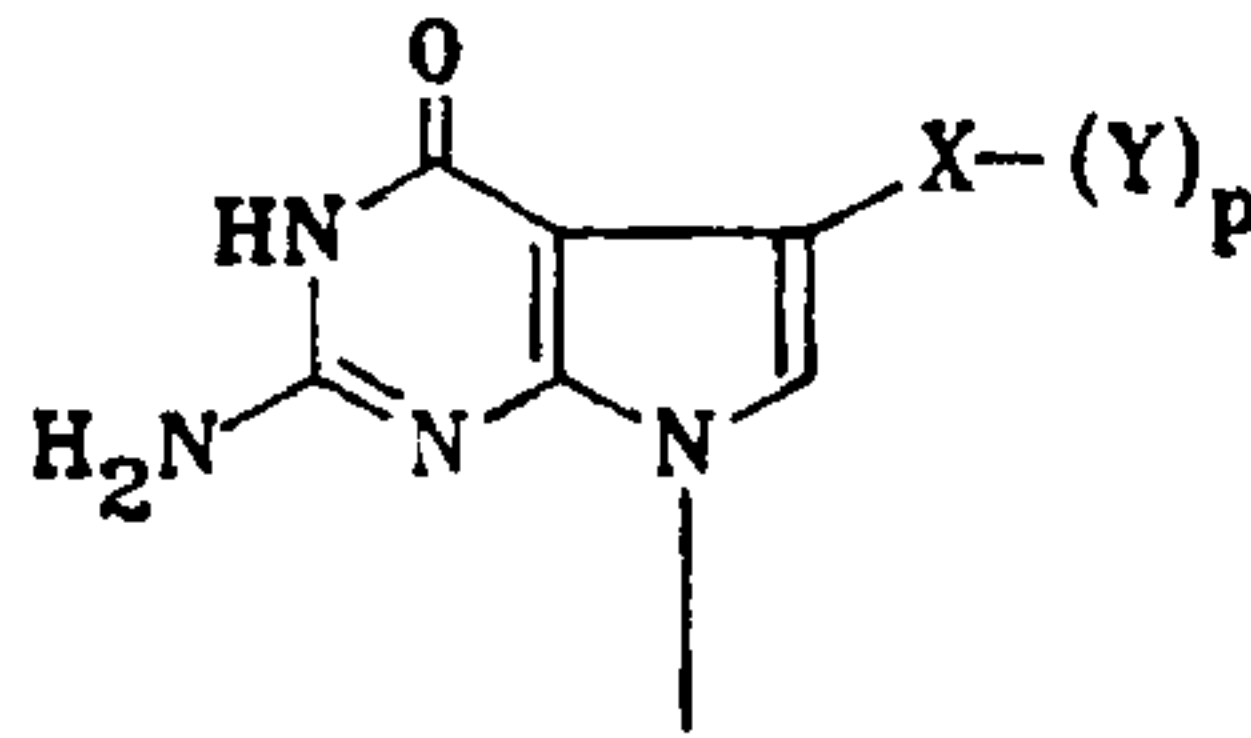

wherein  $-\text{X}-$  and  $-(\text{Y})_p$  taken together comprise a radical selected from the group consisting of

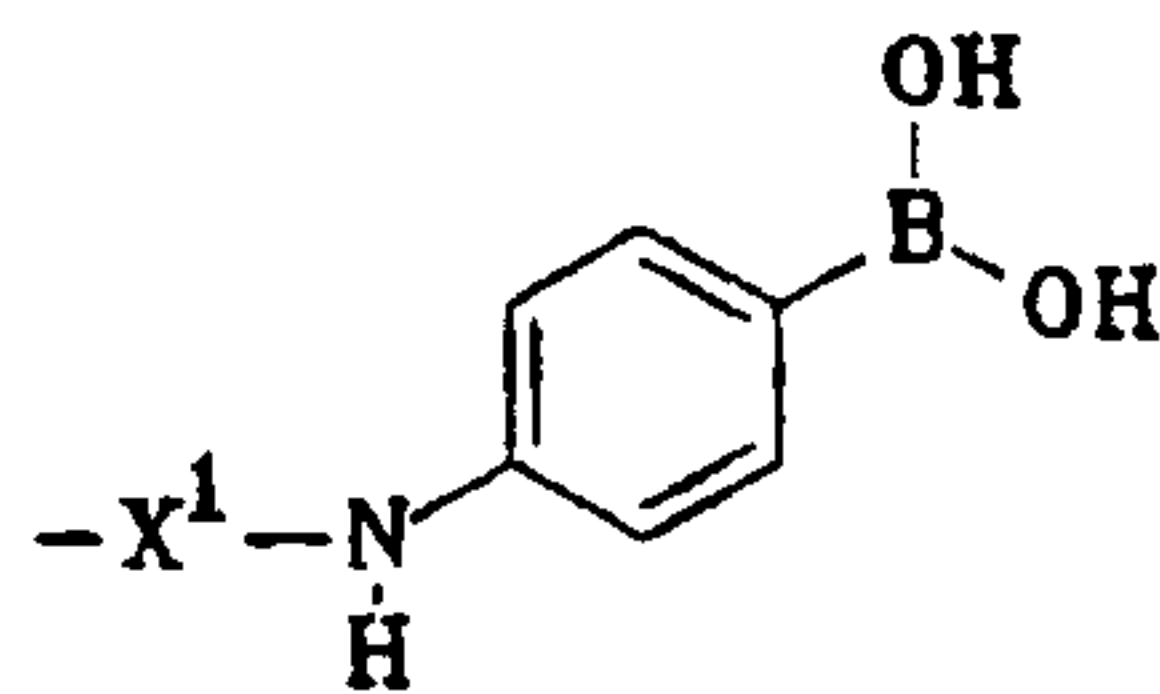
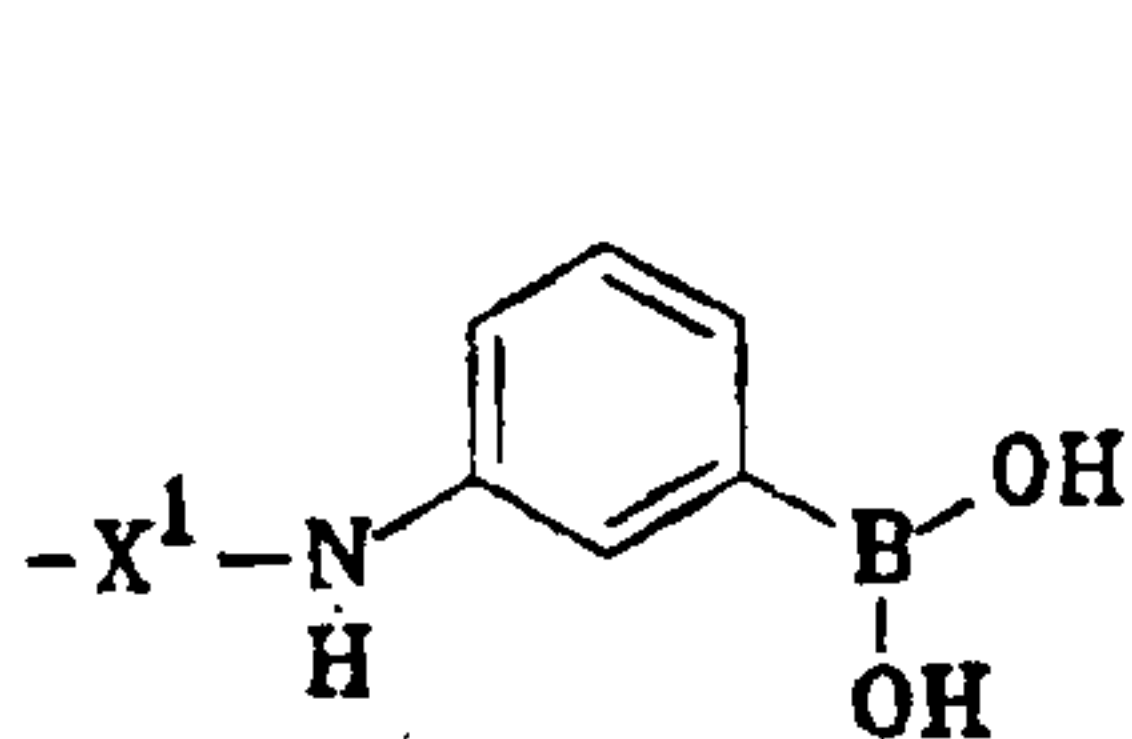

and

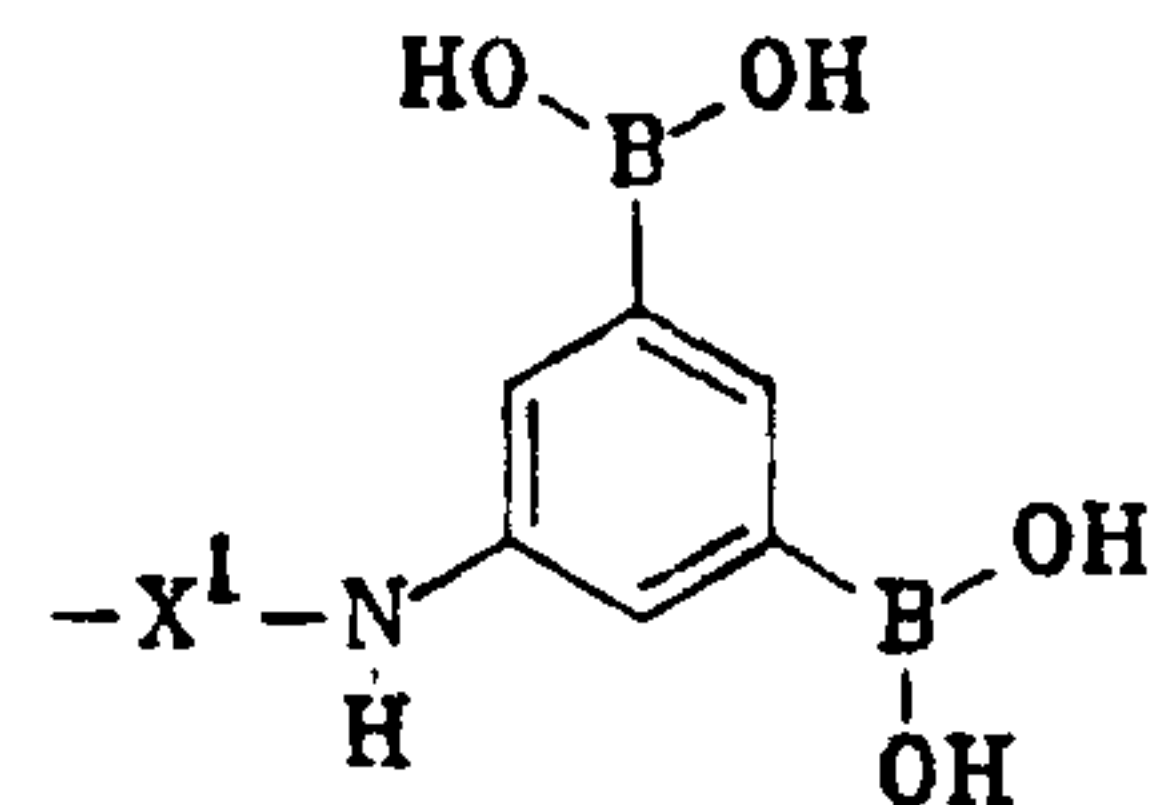

in which  $\text{X}^1$  is a linking group fragment comprising of from 3 to 23 carbon atoms.

14. A method of detecting the presence of a target nucleic acid in a sample, comprising;

- (a) contacting said sample with a modified polynucleotide which is substantially complementary to said target nucleic acid, said modified polynucleotide having the formula:

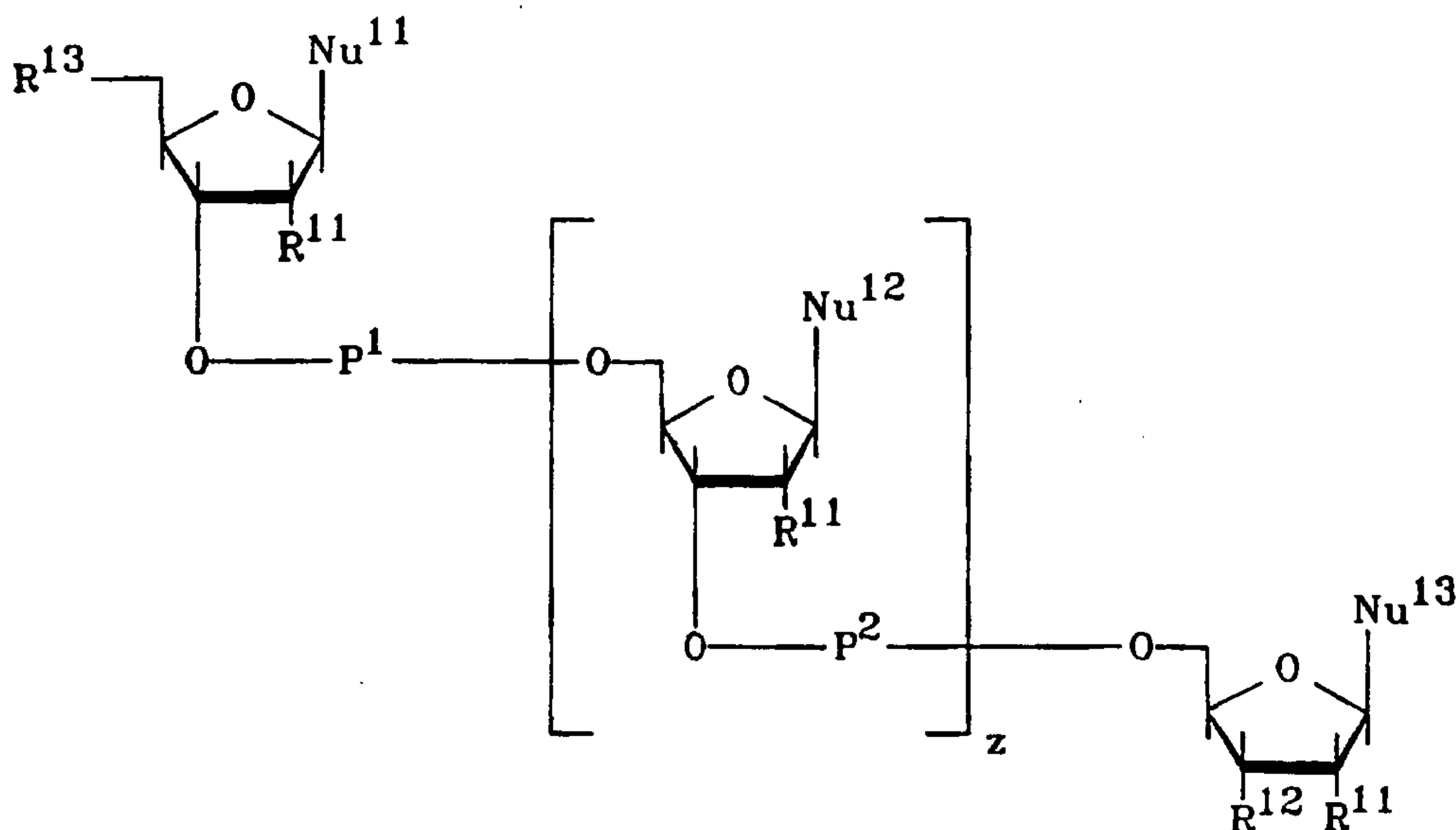

wherein

$z$  is an integer of from 1 to 1000;

each  $R^{11}$  is independently selected from the group consisting of  $-H$  and  $-OH$ ;

$R^{12}$  and  $R^{13}$  are each members independently selected from the group consisting of hydroxyl, protected hydroxyl, monophosphate ester, diphosphate ester and triphosphate ester;

each  $P^1$  and  $P^2$  is independently selected from the group consisting of  $-P(O)(OH)-$ ,  $-P(O)(NH_2)-$ ,  $-P(S)(OH)-$ ,  $-P(O)(CH_3)-$ , and pharmaceutically acceptable salts thereof;

each  $Nu^{11}$ ,  $Nu^{12}$  and  $Nu^{13}$  is independently selected from the group consisting of

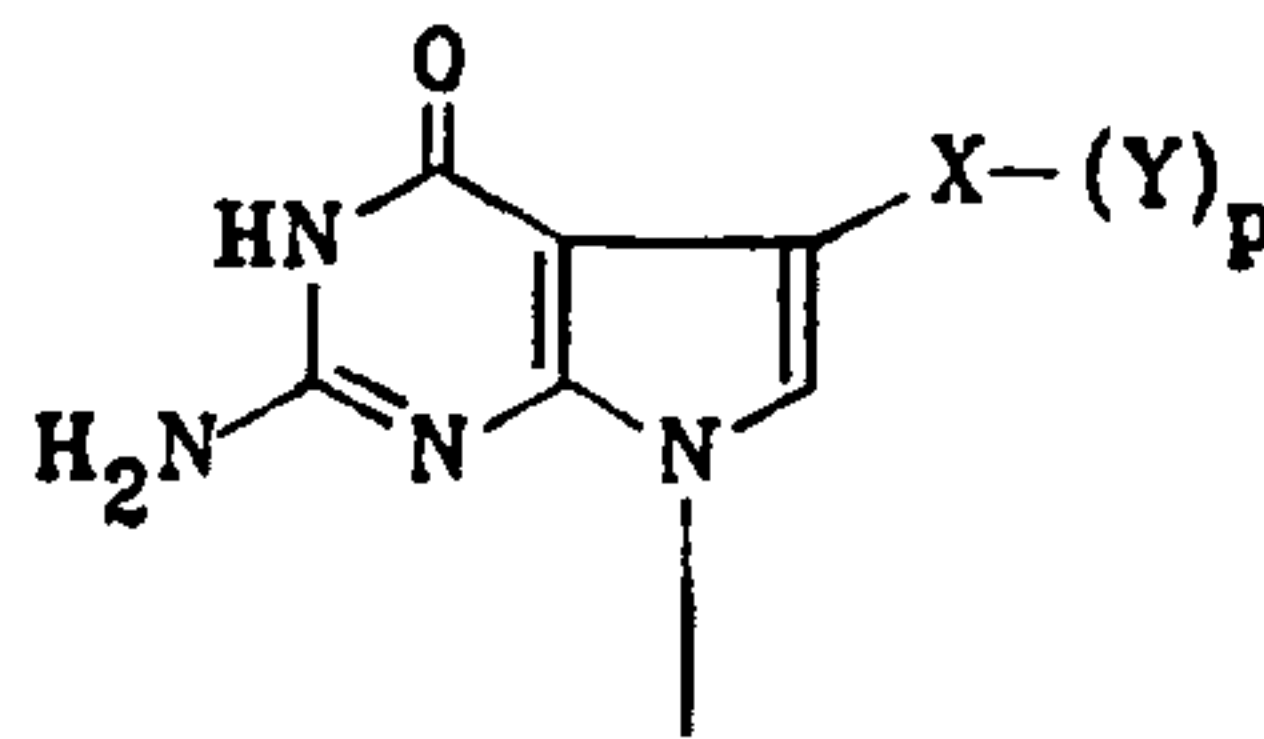
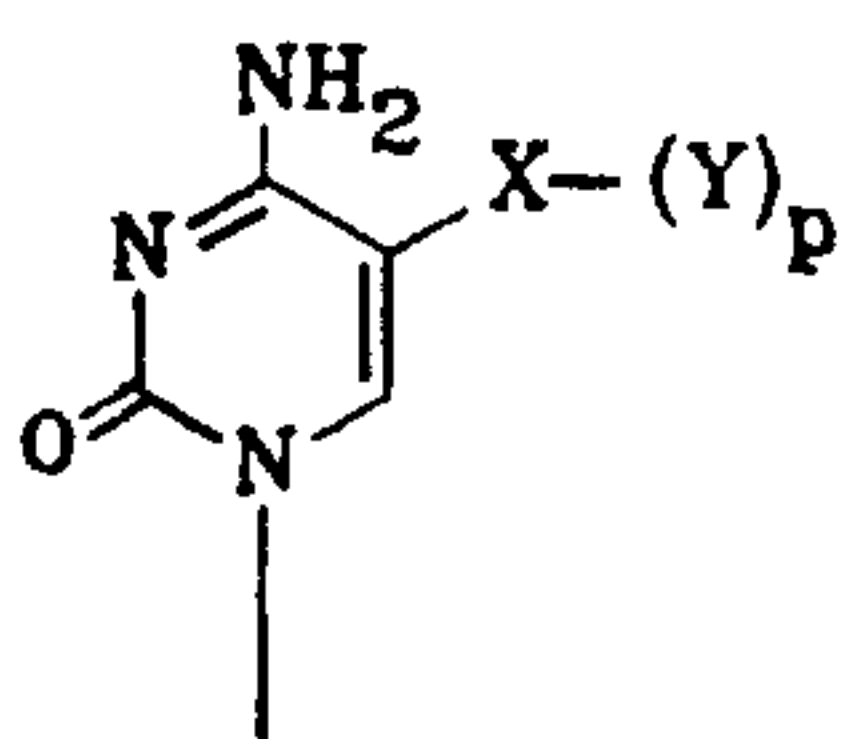
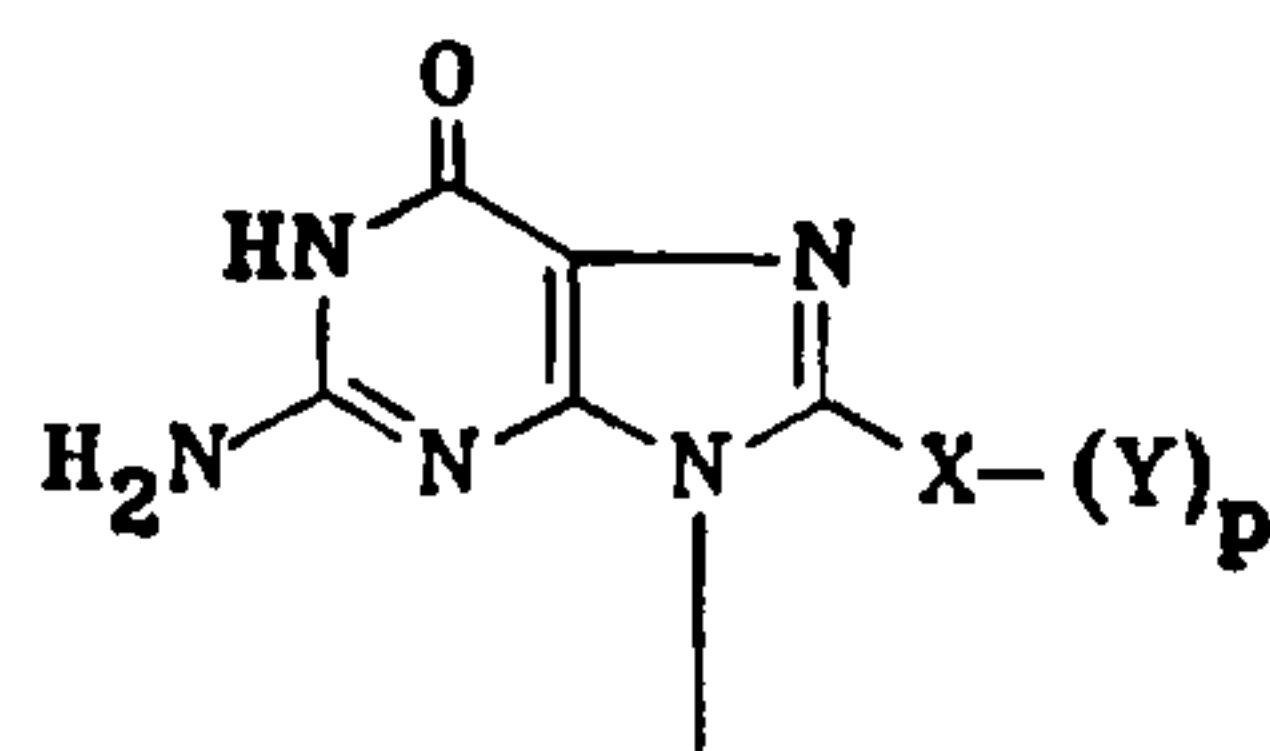
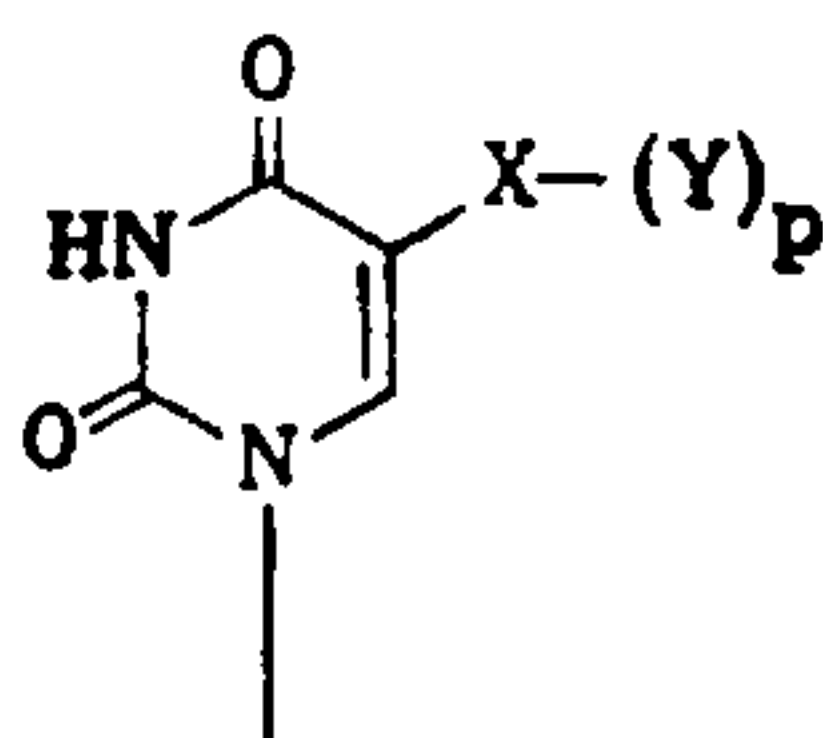
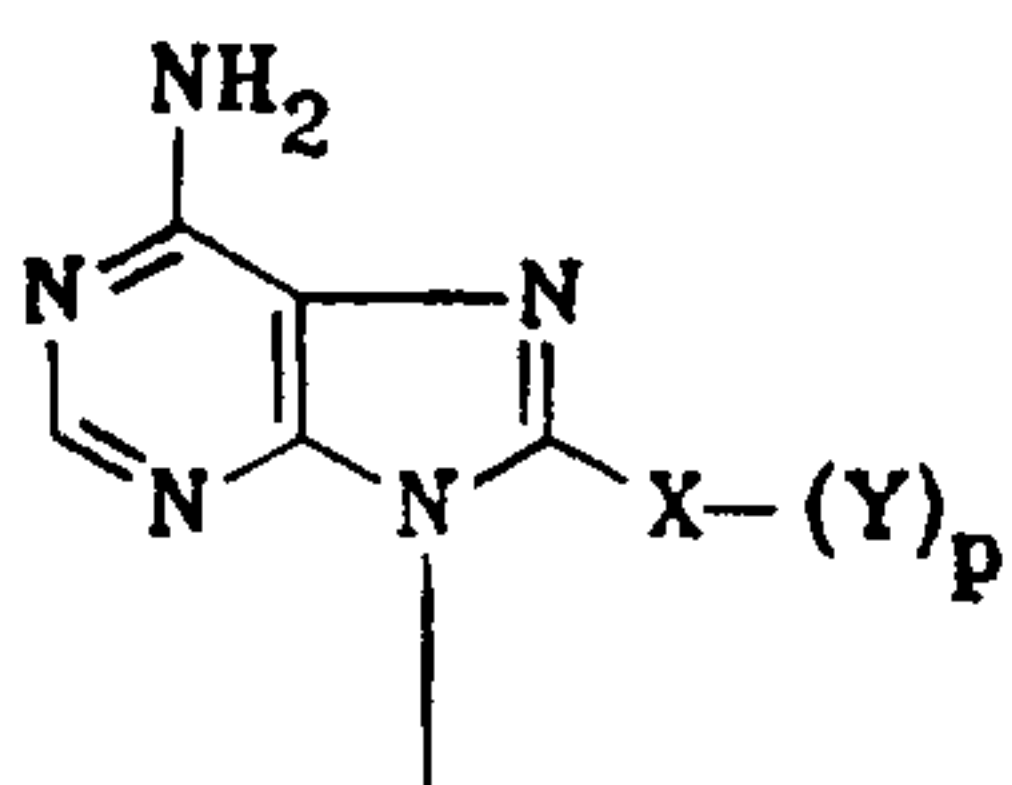

adenine, guanine, thymine and cytosine,

wherein

X is a linking group comprising of from 3 to 30 carbon atoms;

Y is a boron-containing moiety which forms a complex with detectable boronic acid complexing agents; and

p is an integer of from 1 to 3;

with the proviso that at least one and no more than thirty of Nu<sup>11</sup>, Nu<sup>12</sup> and Nu<sup>13</sup> are other than adenine, guanine, thymine or cytosine,

under conditions sufficient to hybridize said modified polynucleotide to said target nucleic acid thereby forming a hybridized complex;

- (b) contacting said hybridized complex with a boronic acid complexing agent, said agent comprising an indicator; and
- (c) detecting the presence of said indicator, thereby detecting the presence of said target nucleic acid.

15. A method in accordance with claim 14, wherein said indicator is a fluorescent indicator, electron dense, or an enzyme which produces a detectable substance.

16. A method in accordance with claim 15, wherein said indicator is an enzyme and said detectable substance is detected using colorimetric or chemiluminescent techniques.

17. A method in accordance with claim 15, wherein said indicator is an electron dense indicator selected from the group consisting of ferritin, hemocyanin and colloidal gold.

18. A method in accordance with claim 14, wherein said indicator is a latex sphere or liposome containing a plurality of fluorescent compounds.

19. A method in accordance with any one of claims 14 to 18, wherein said boronic acid complexing agent further comprises a moiety selected from the group consisting of salicyl hydroxamic acid and dihydroxybenzohydroxamic acid.

20. A method in accordance with any one of claims 14 to 18, wherein said boronic acid complexing agent further comprises a moiety selected from the group consisting of alkyl 1,3-diols and substituted *ortho*-hydroxy benzohydroxamic acids.

Figure 1

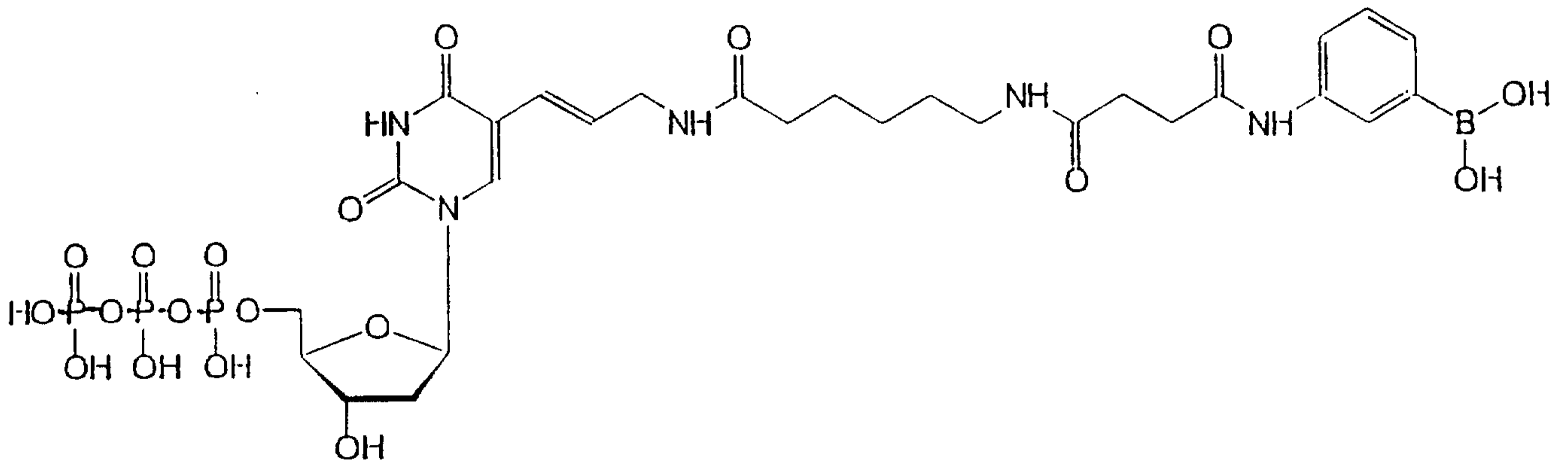

PBA-XX-dUTP

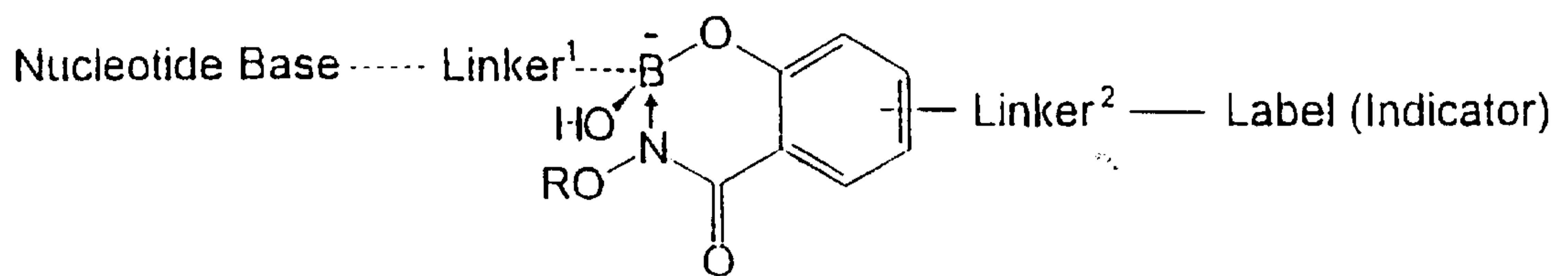

Complex

2/21

Figure 2

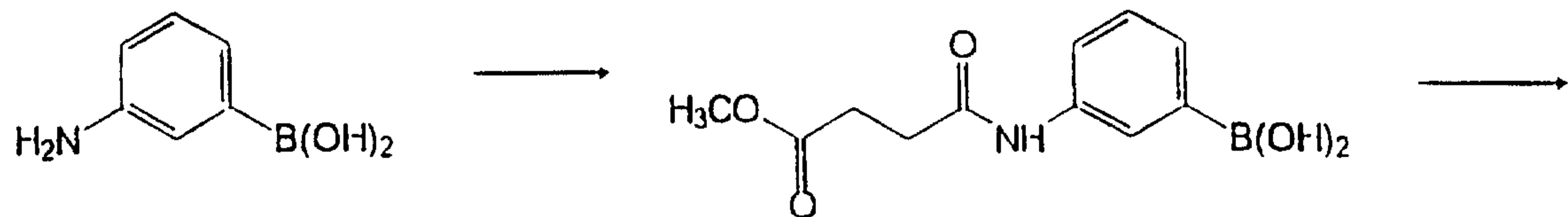
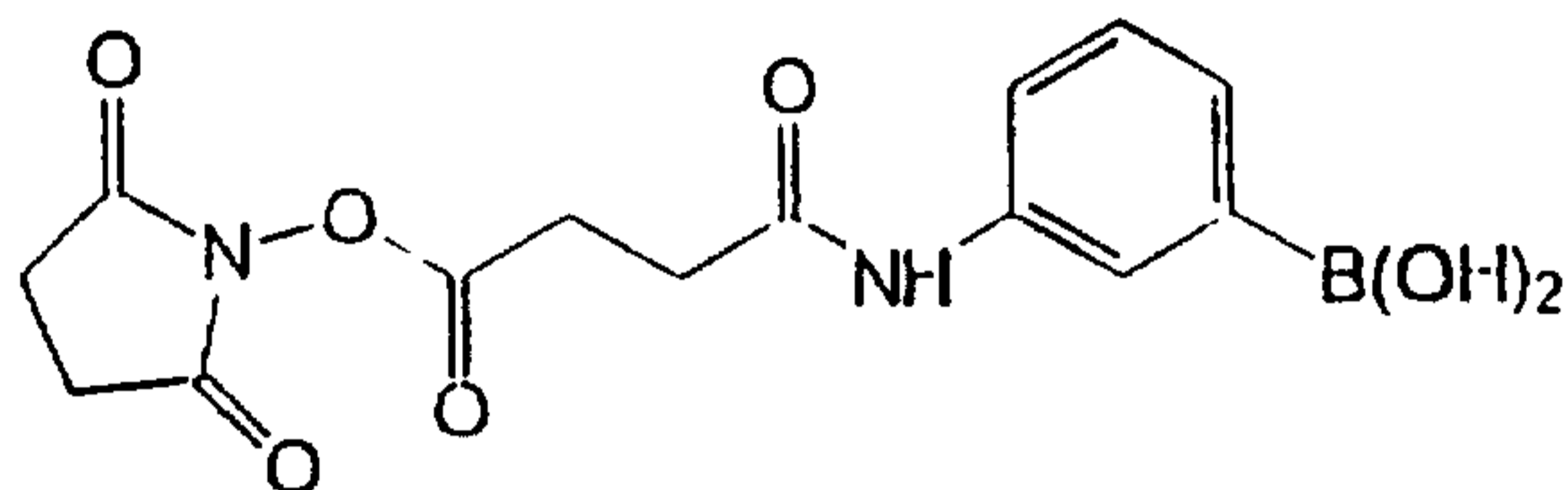
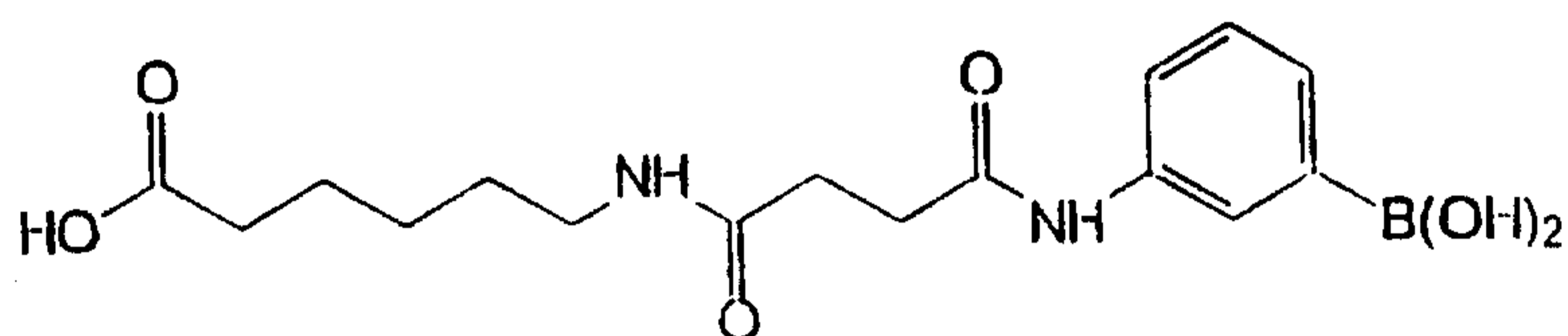
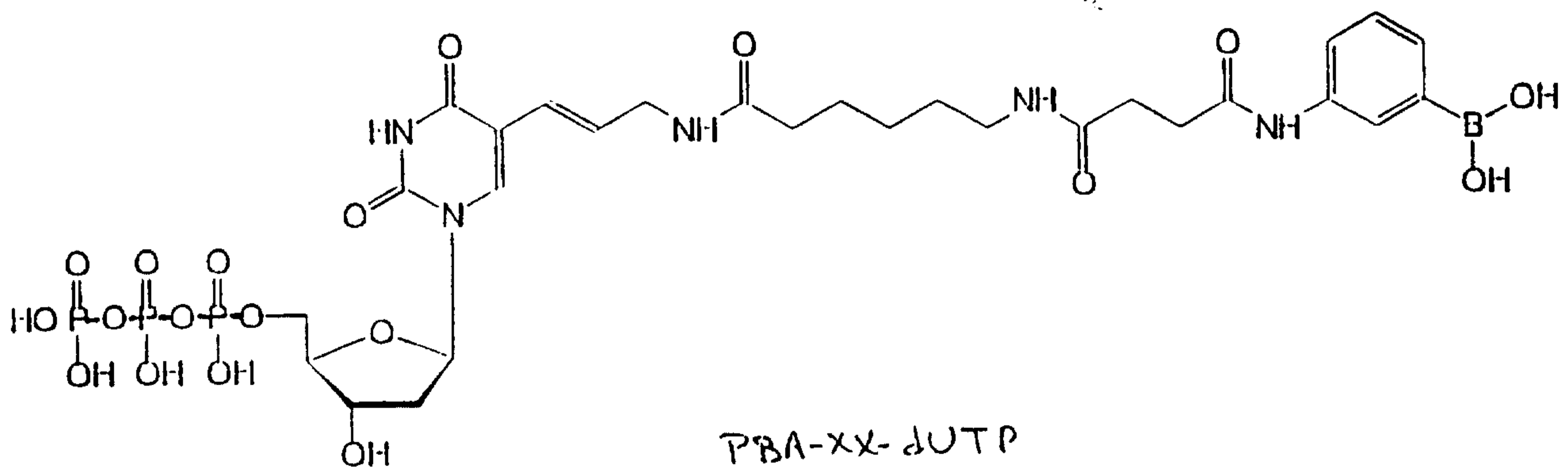
2a2b2c

PBA-XX-dUTP

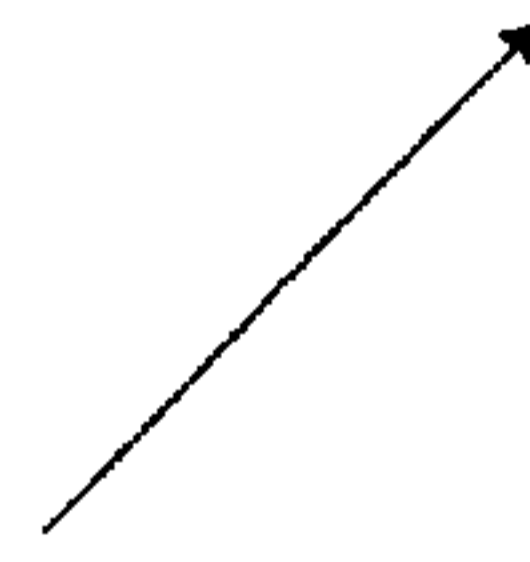
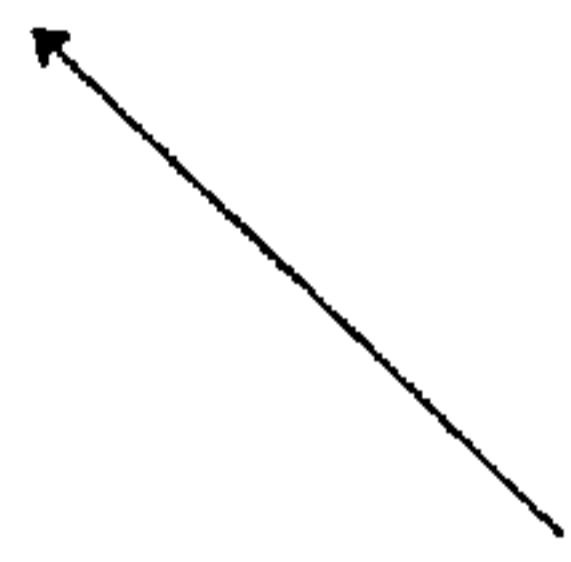
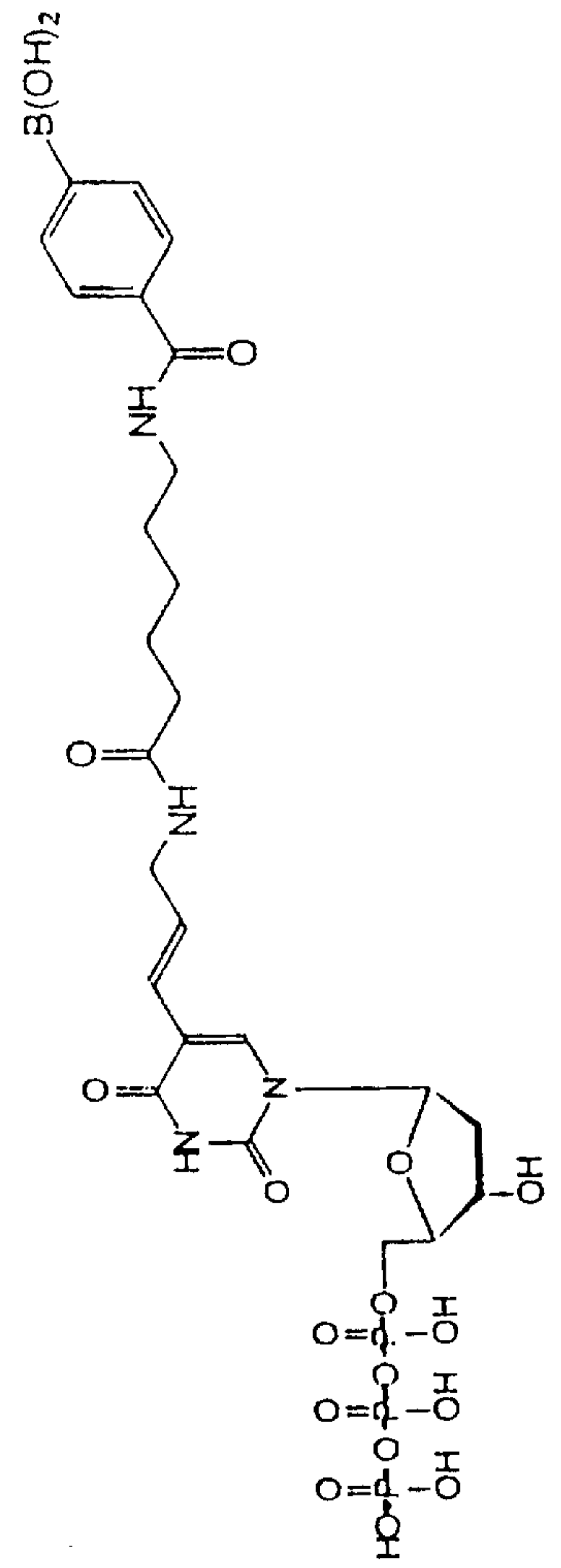
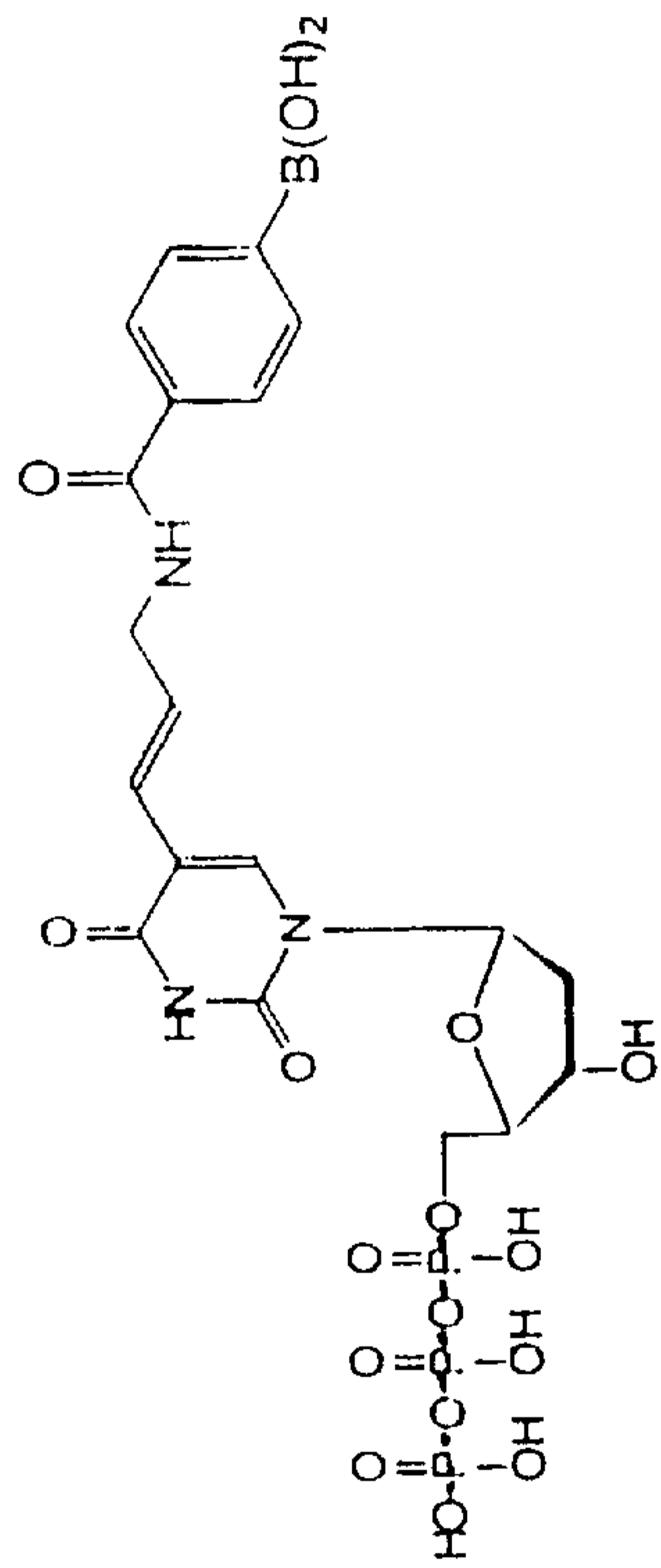
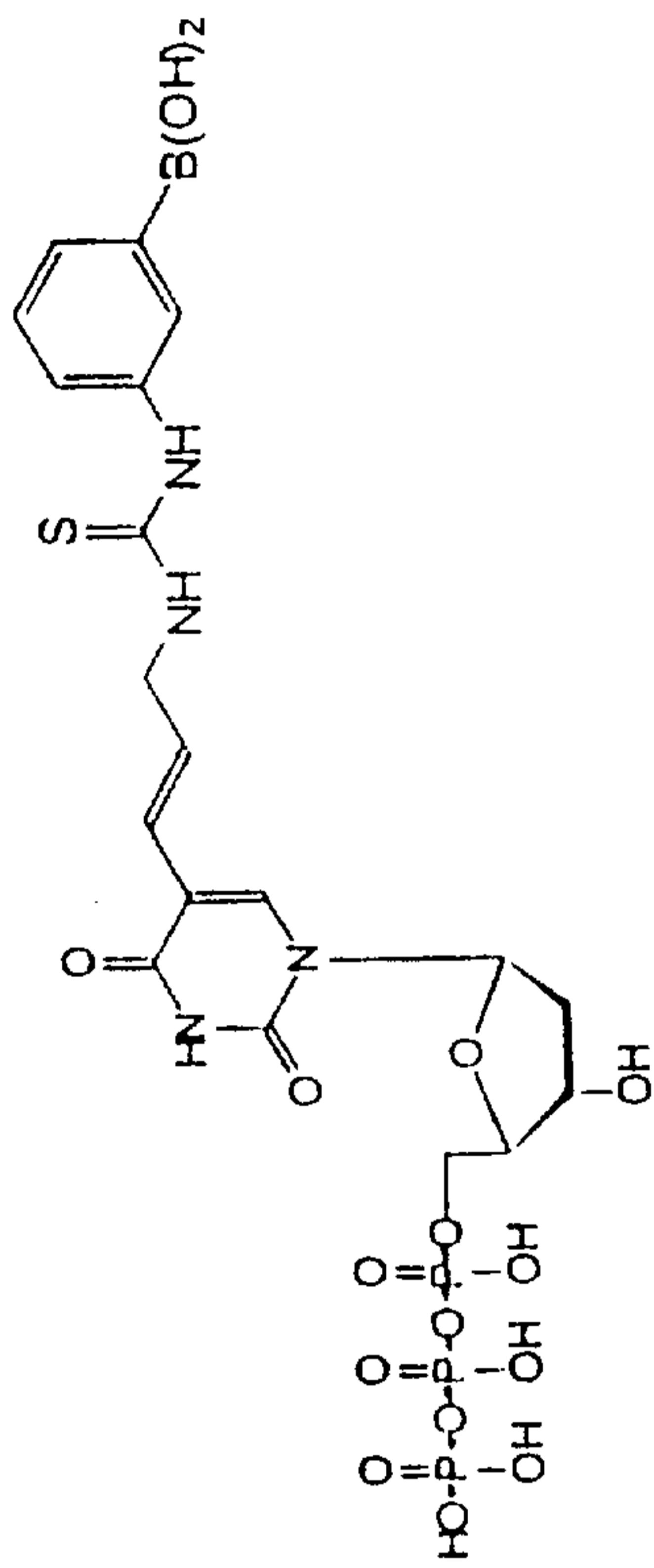

Figure 3

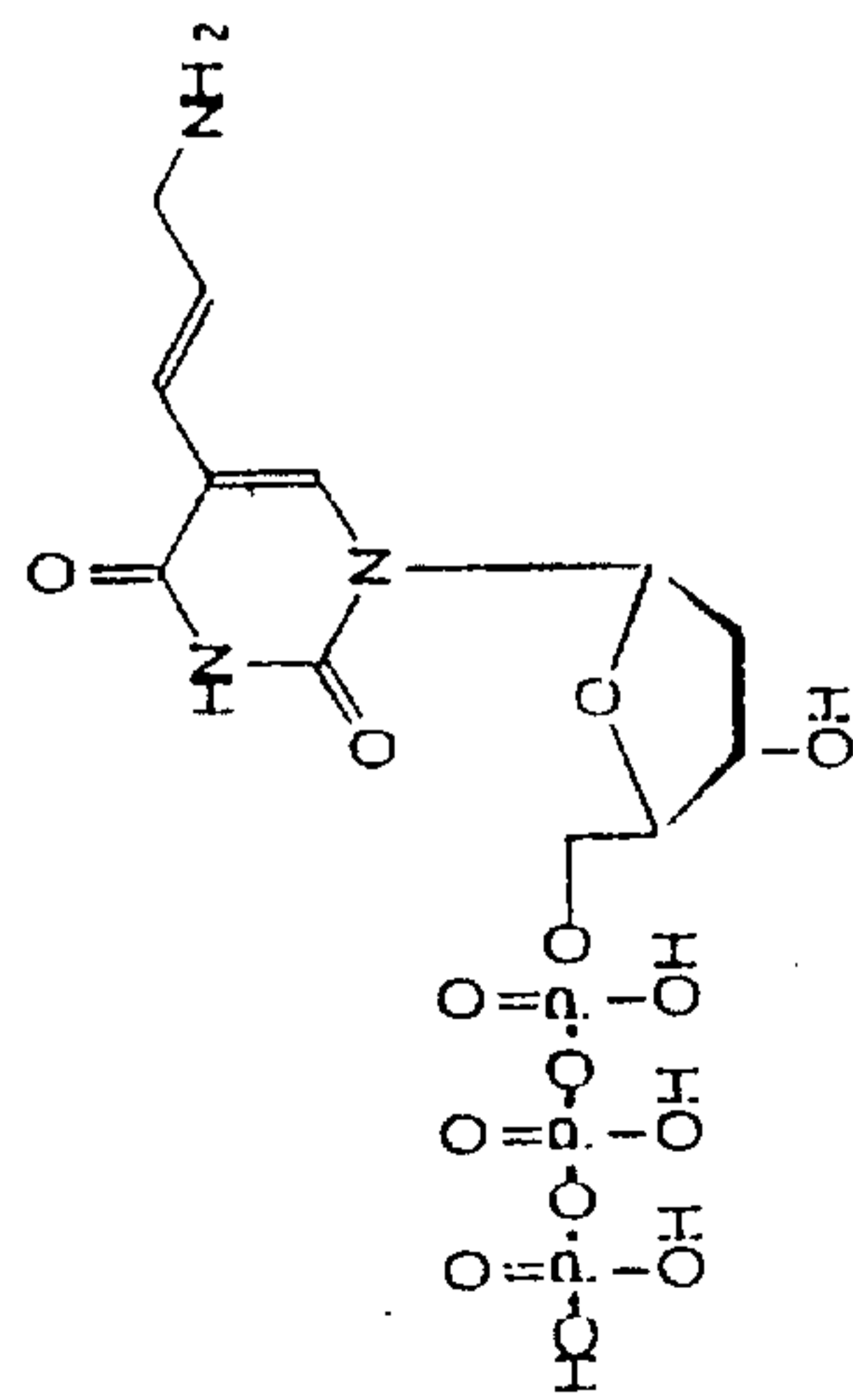
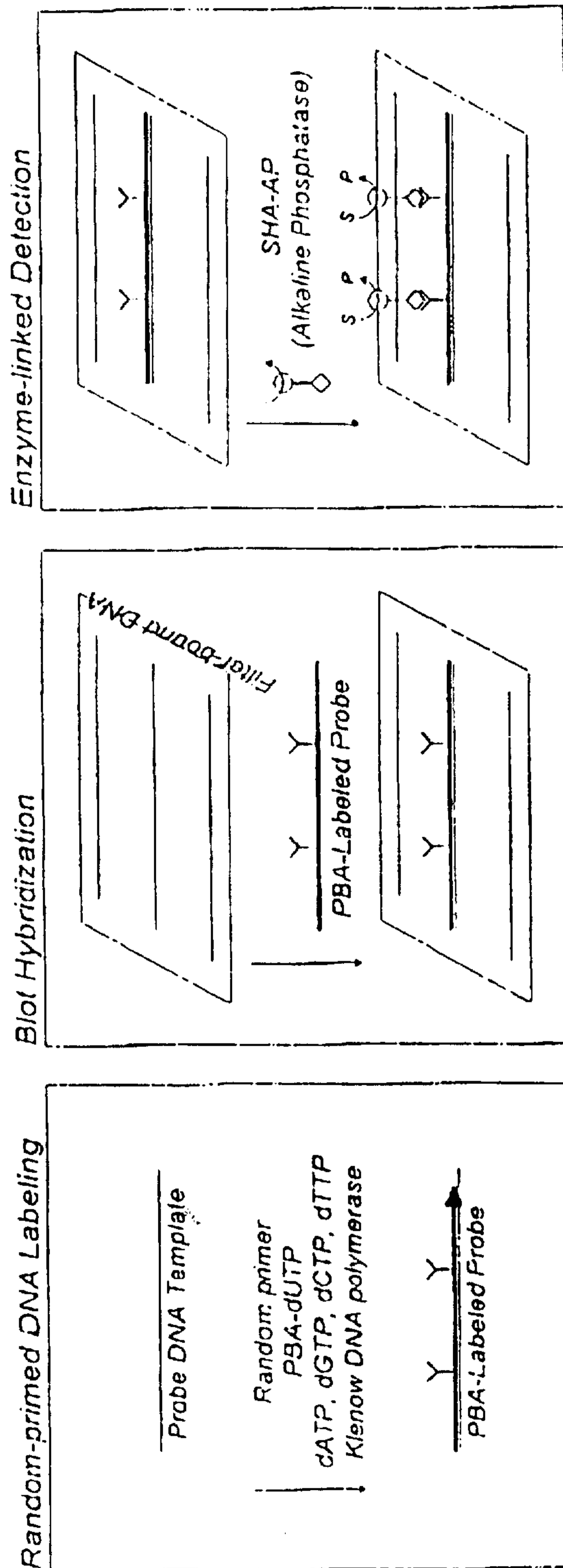



Figure 4

# Random Primed Labeling DNA Probe Detection System



4C

4B

4A

Figure 5

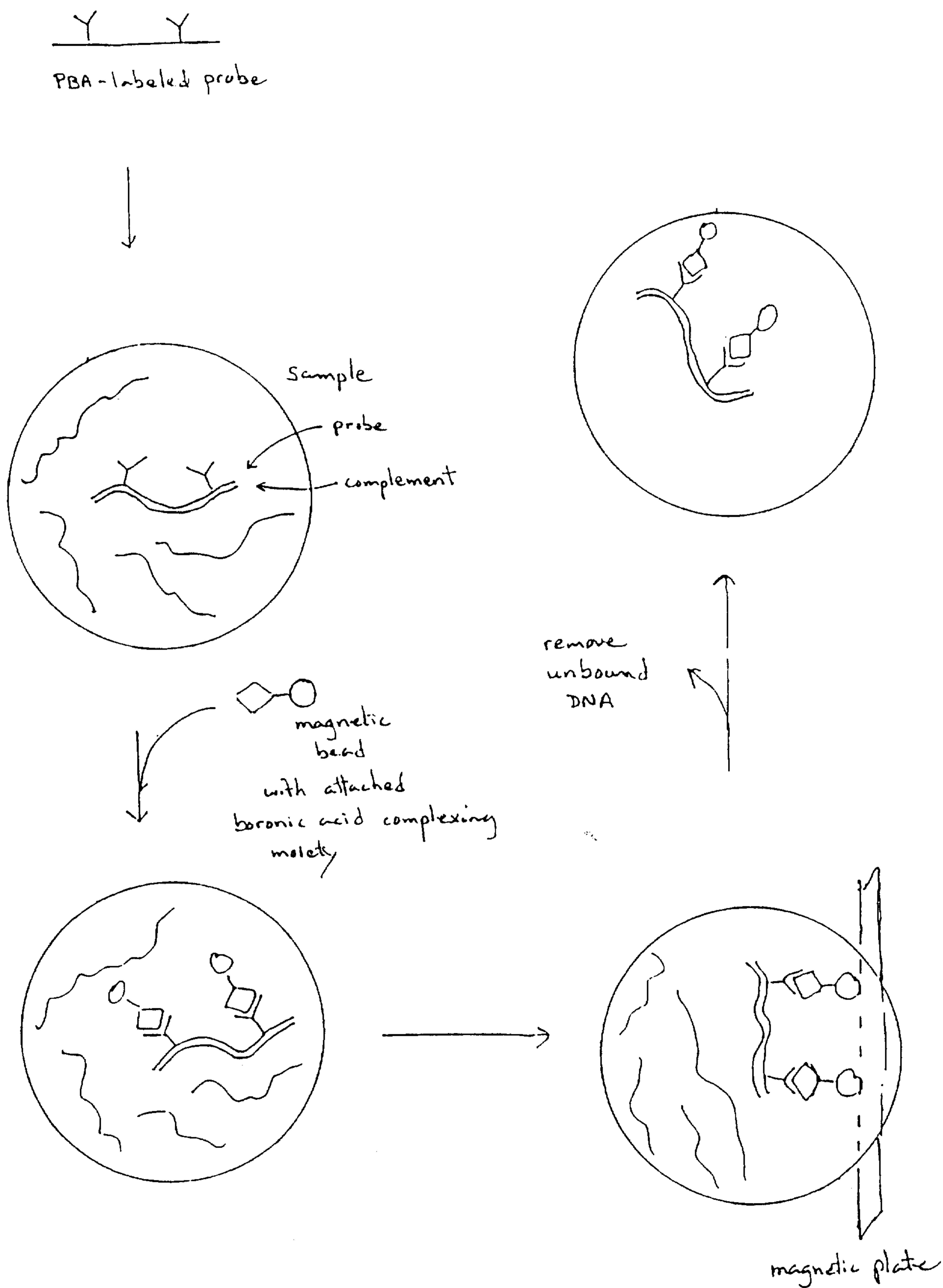

6/21

Figure 6

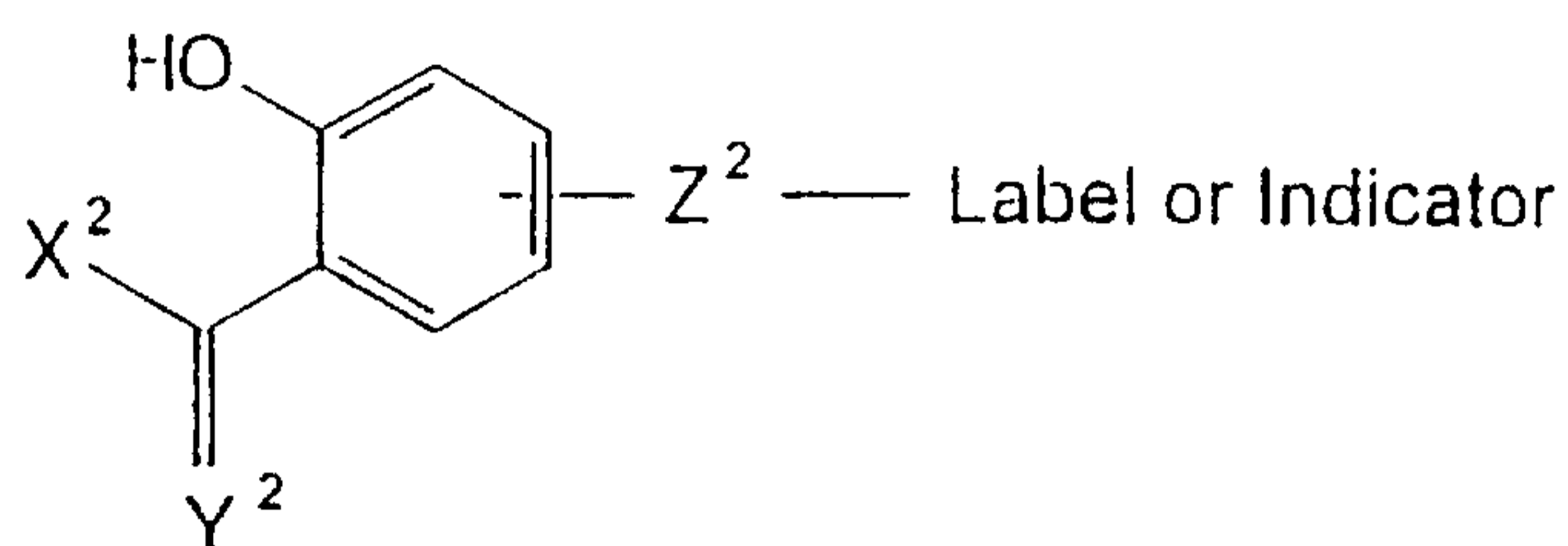

$X^2 = \text{OH}, \text{NH}_2, \text{NHR}, \text{NHOH}, \text{NHOR}$   
(R is lower alkyl)

$Y^2 = \text{O}, \text{S or NH}$

$Z^2$  is, for example,

$-\text{NHCO}(\text{CH}_2)_n-\text{CO}-$

$-\text{NHCO}(\text{CH}_2)_m-\text{SS}-(\text{CH}_2)_n-\text{CO}-$

or  $-\text{NHCO}(\text{CH}_2)_k\text{O}(\text{CH}_2\text{CH}_2\text{O})_j(\text{CH}_2)_n\text{CO}-$

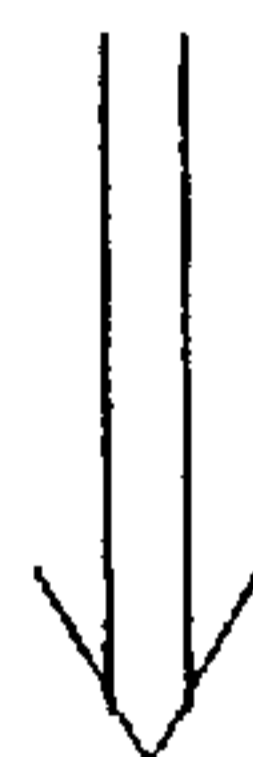

The subscripts n, m, j and k  
each represent integers of  
from 1 to 6

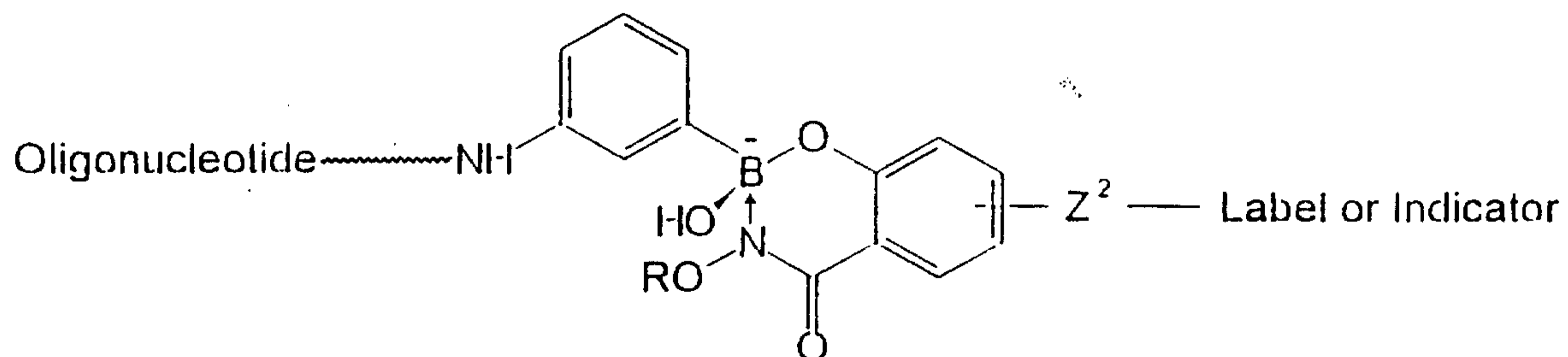

Labeled Complex ( $Y^2 = \text{O}, X^2 = \text{NHOR}$ )

7/21

Figure 7

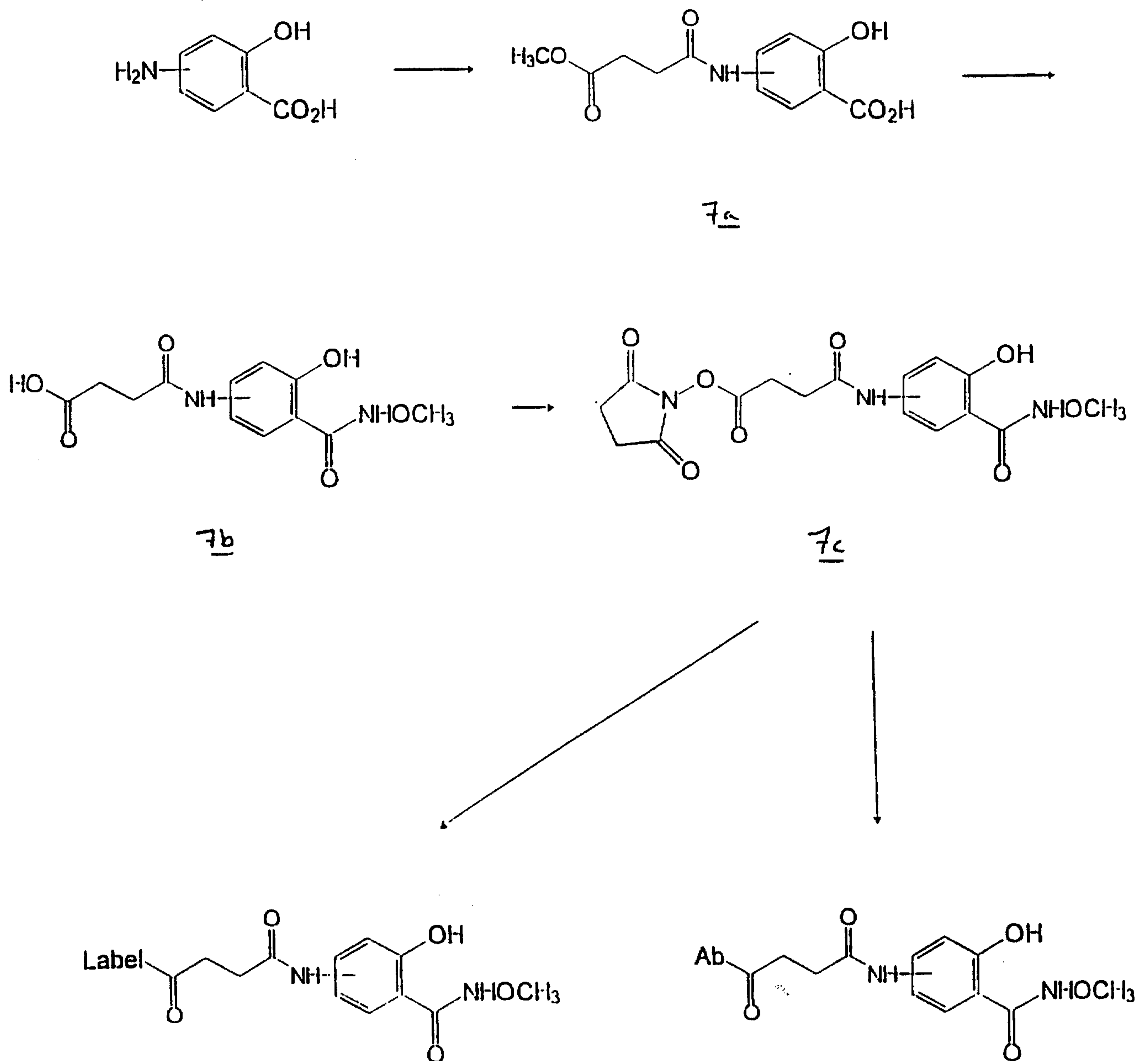

8/21

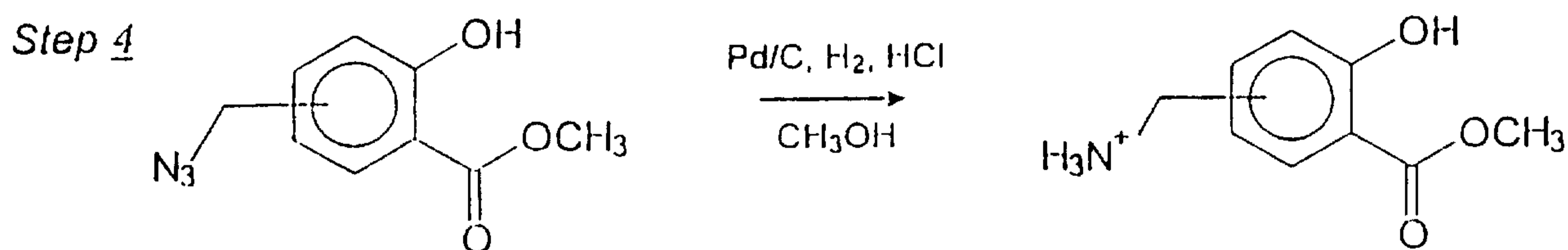
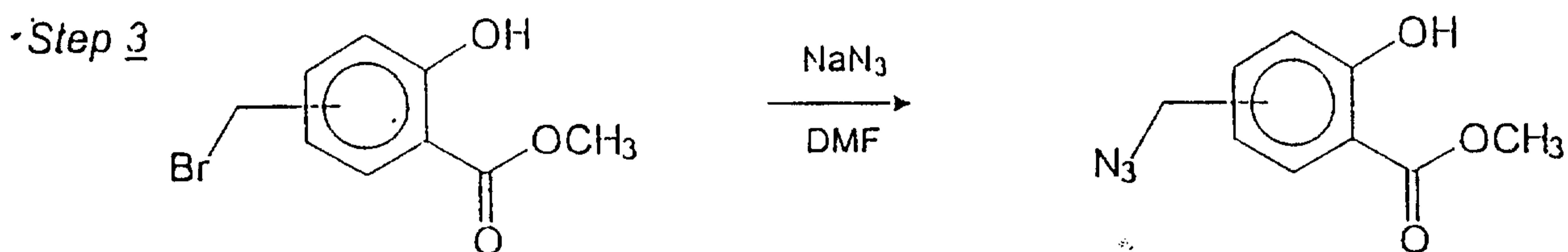
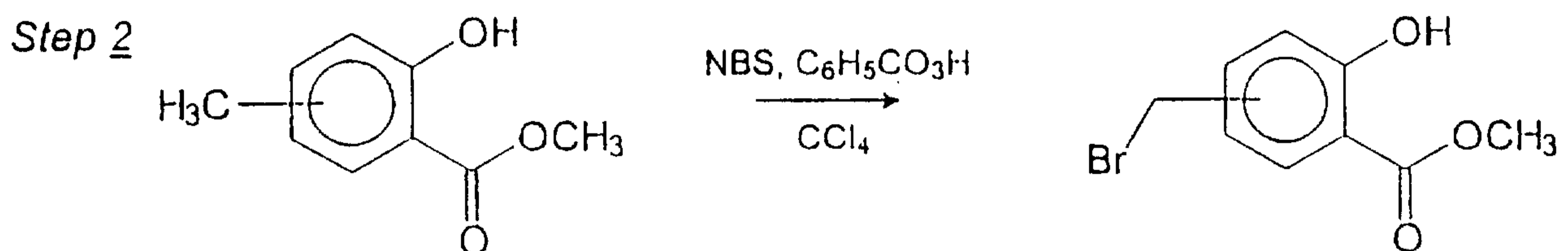
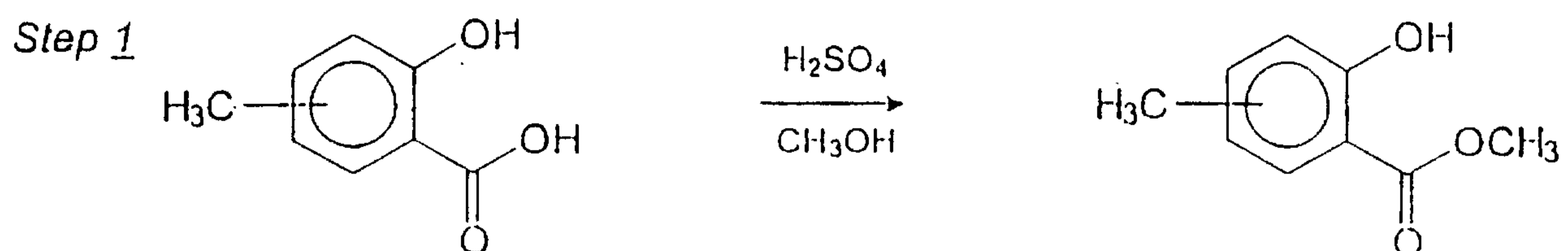
*Figure 8*

9/21

## Figure 9

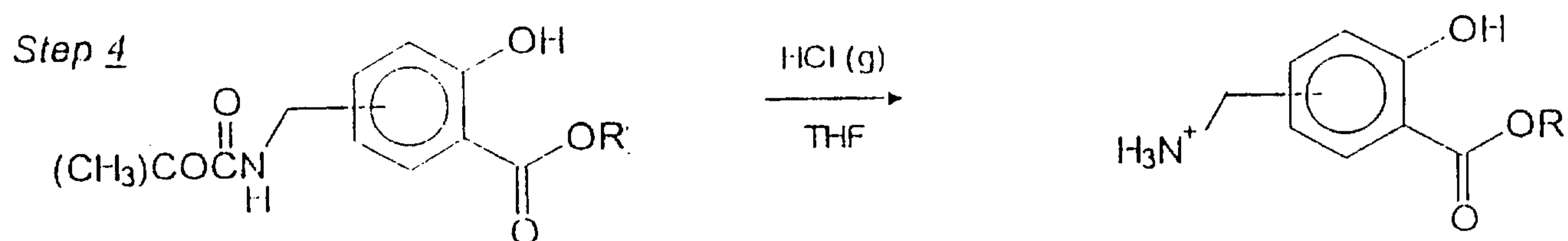
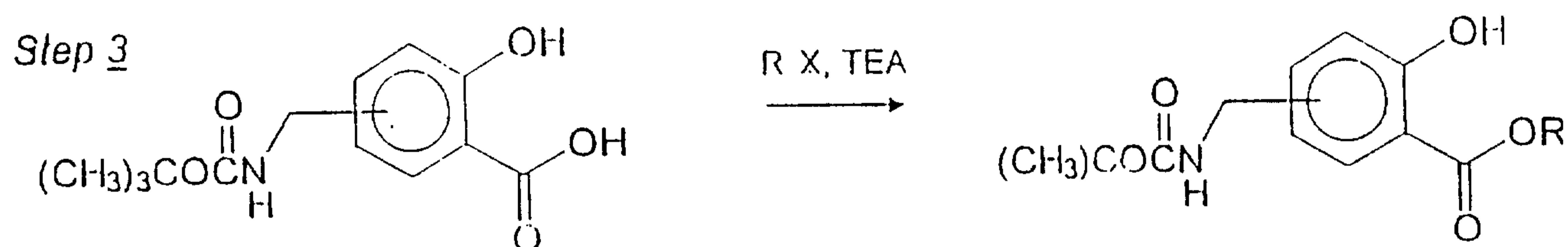
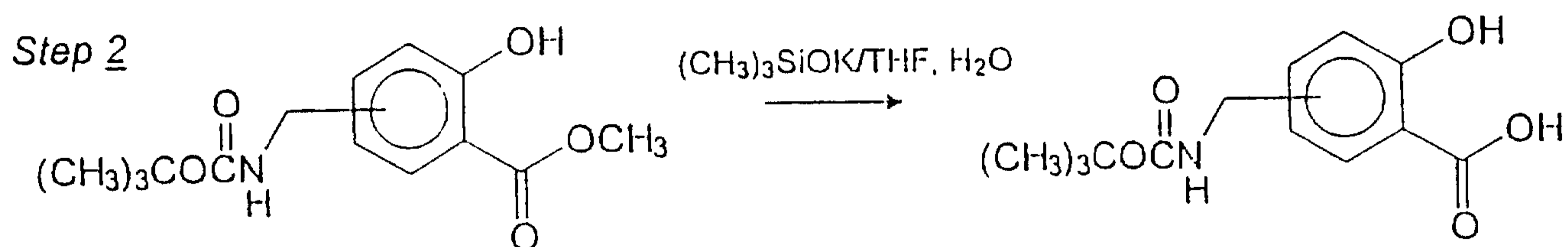
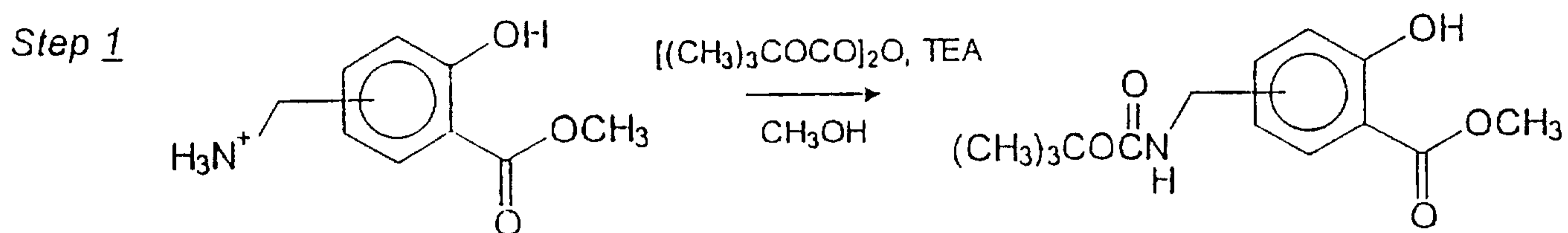

10/21

## Figure 10

Step 1

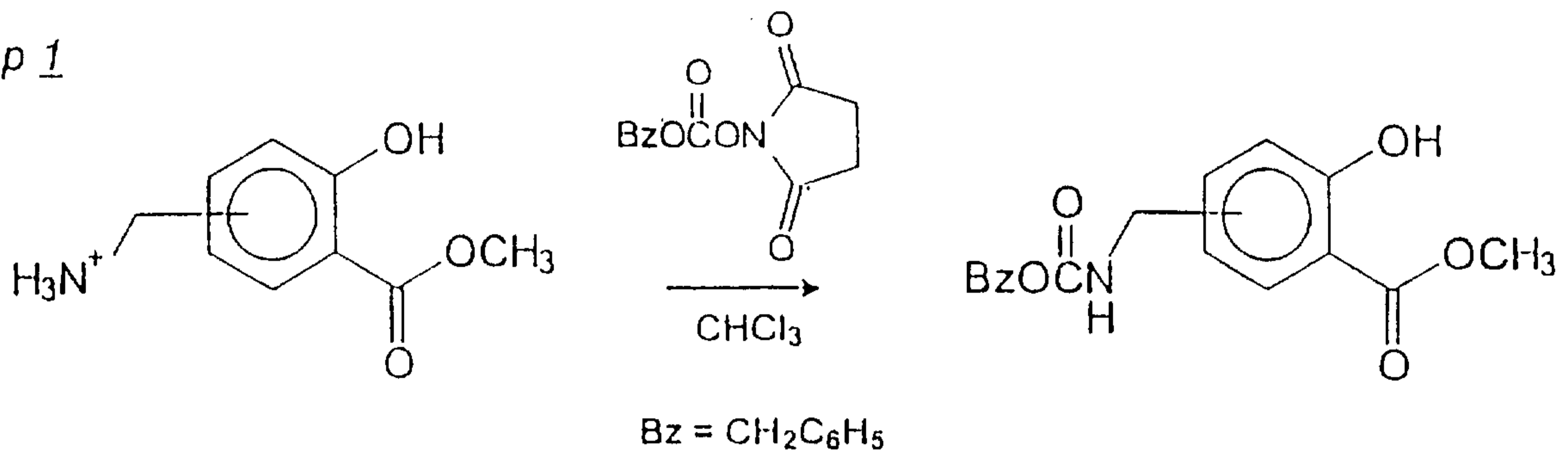

Step 2

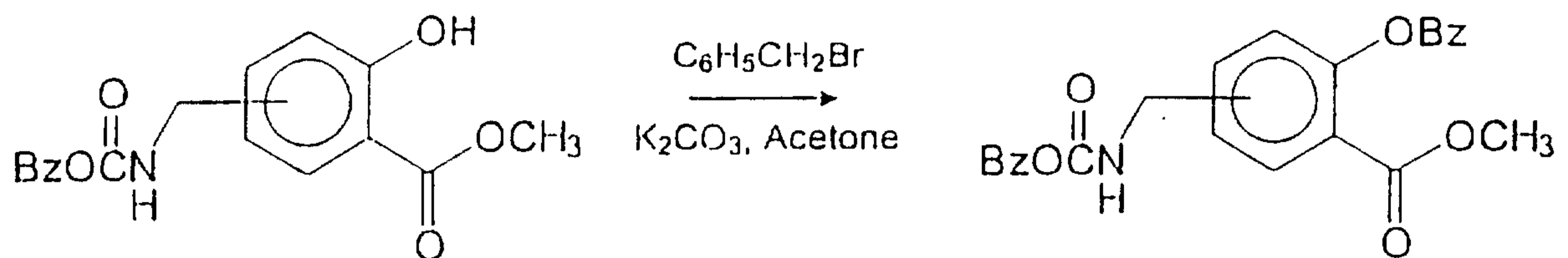

Step 3

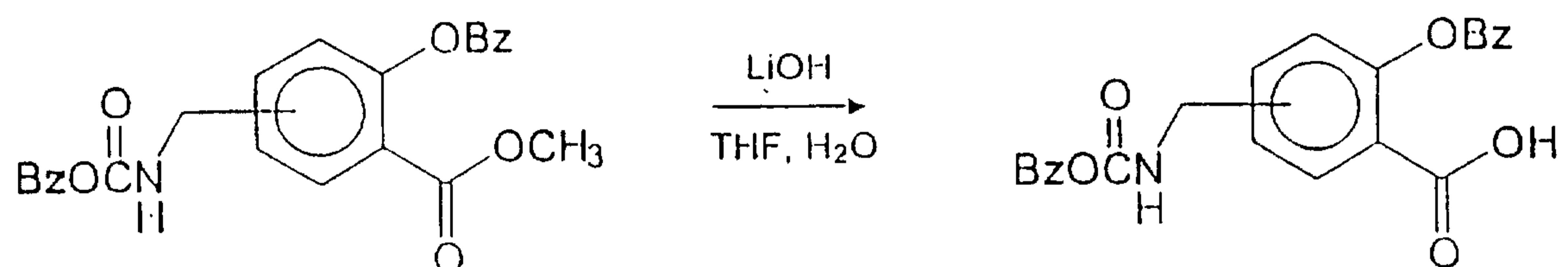

Step 4

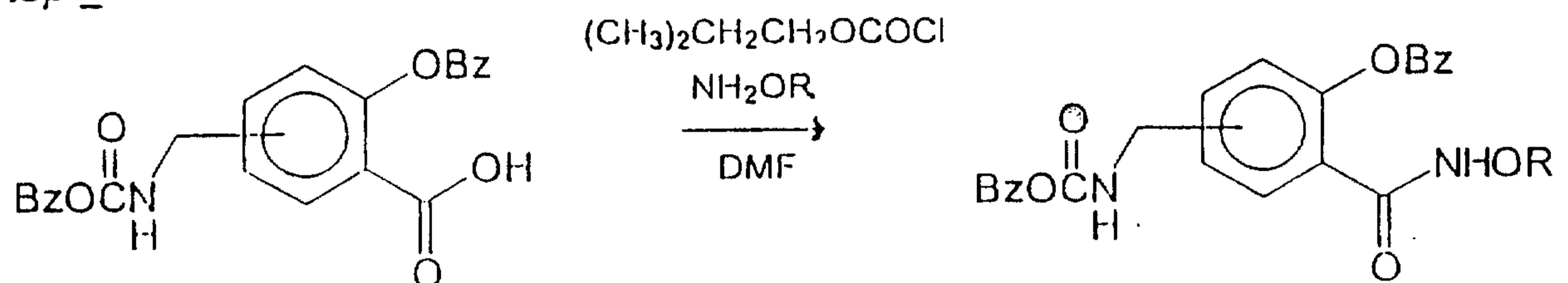

Step 5

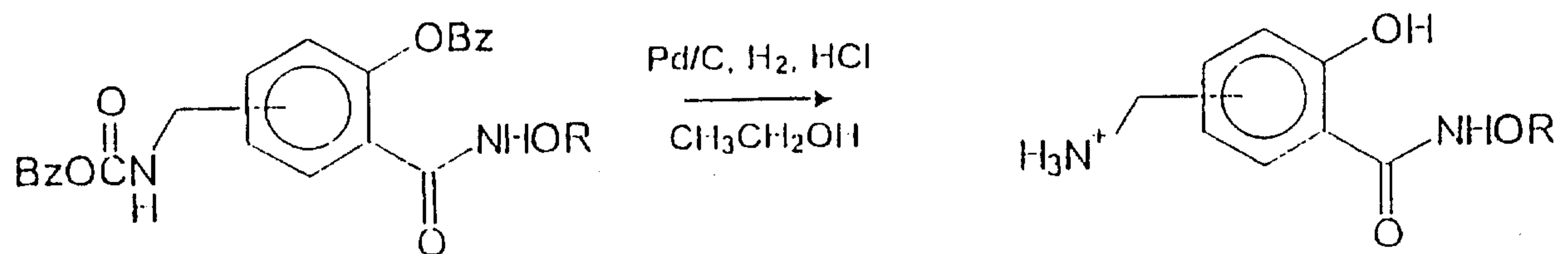

11/21

Figure 11

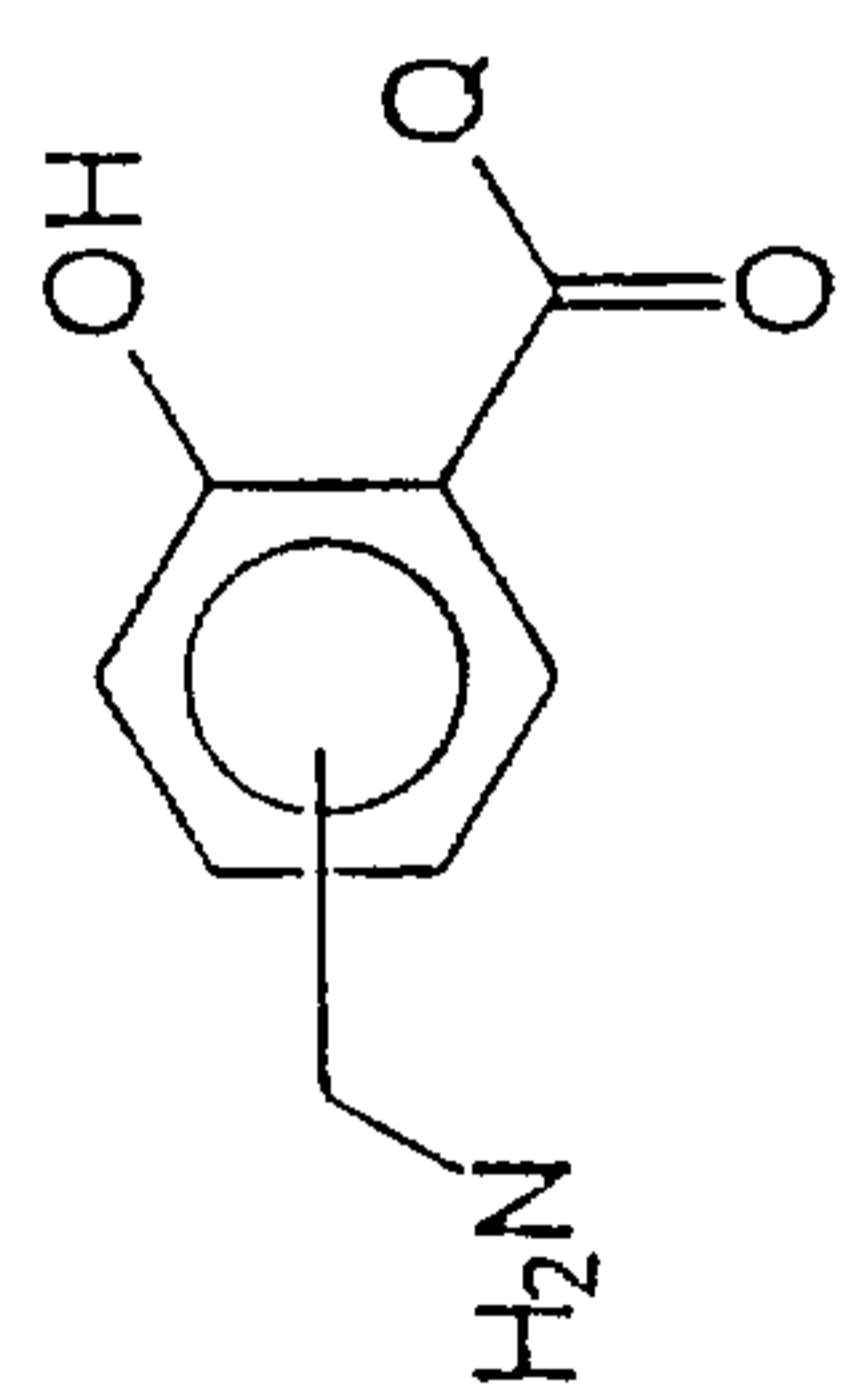

Q = OR, NHOR

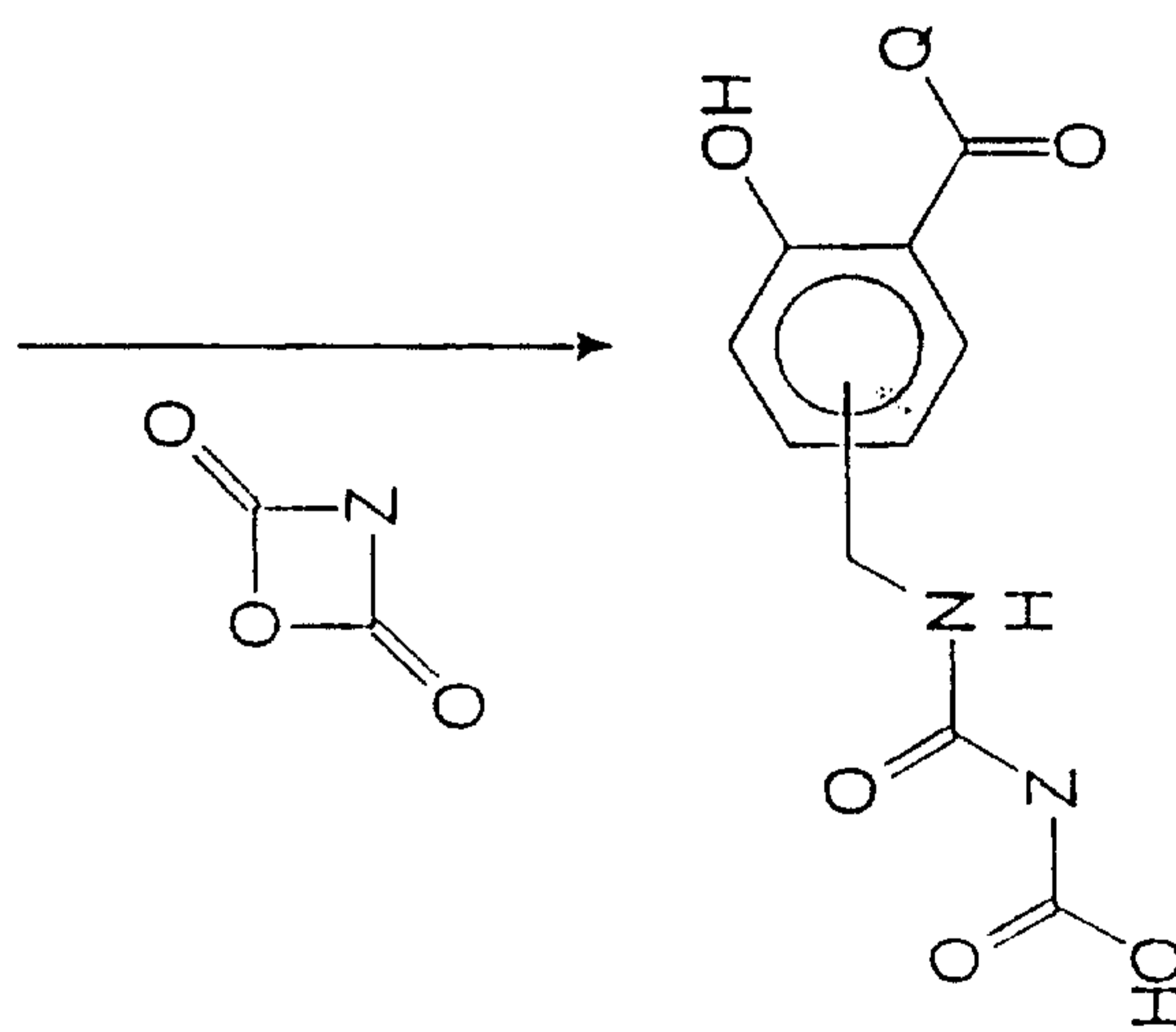

Z is (CH<sub>2</sub>)<sub>n</sub>

n is 2-6

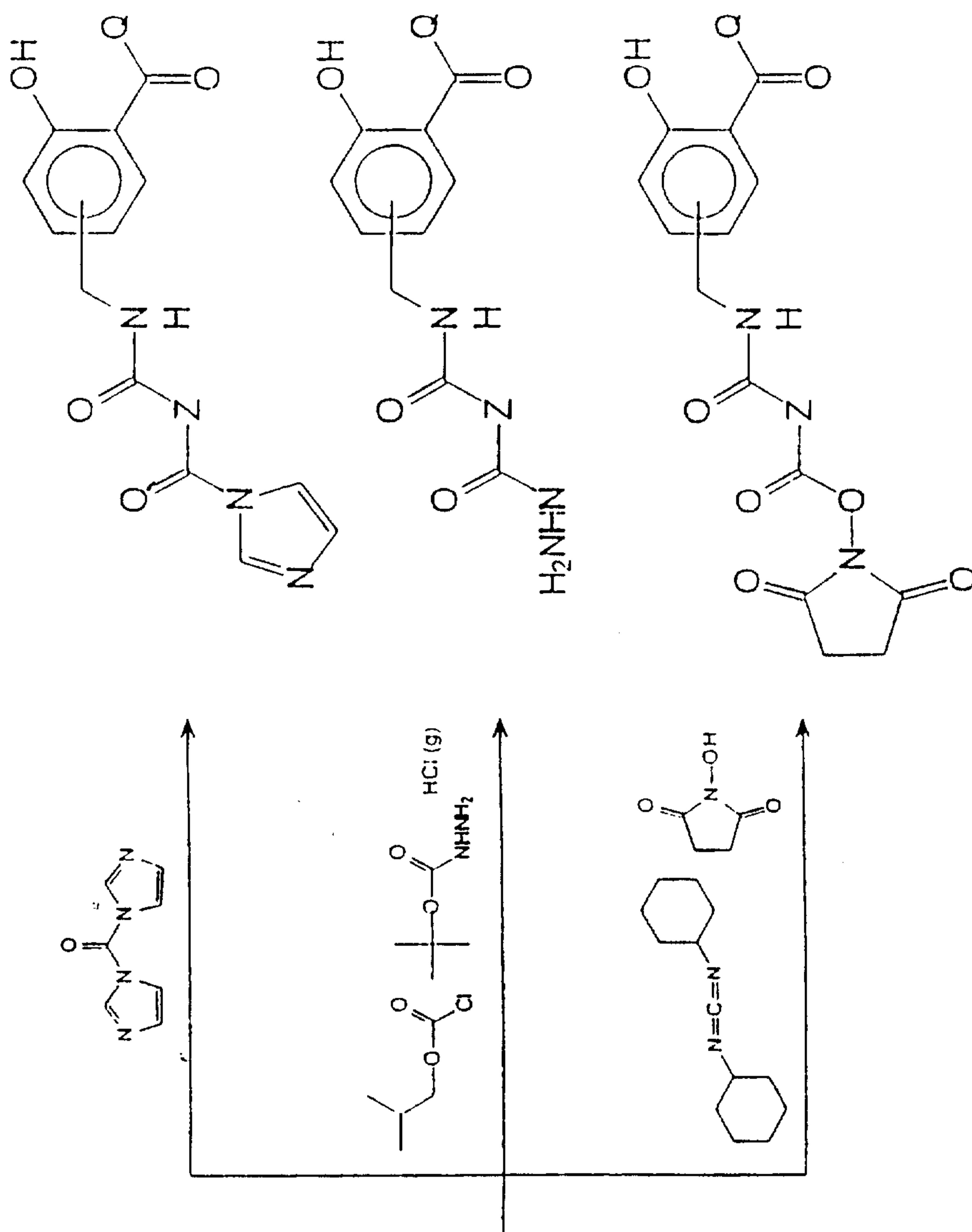



12/21

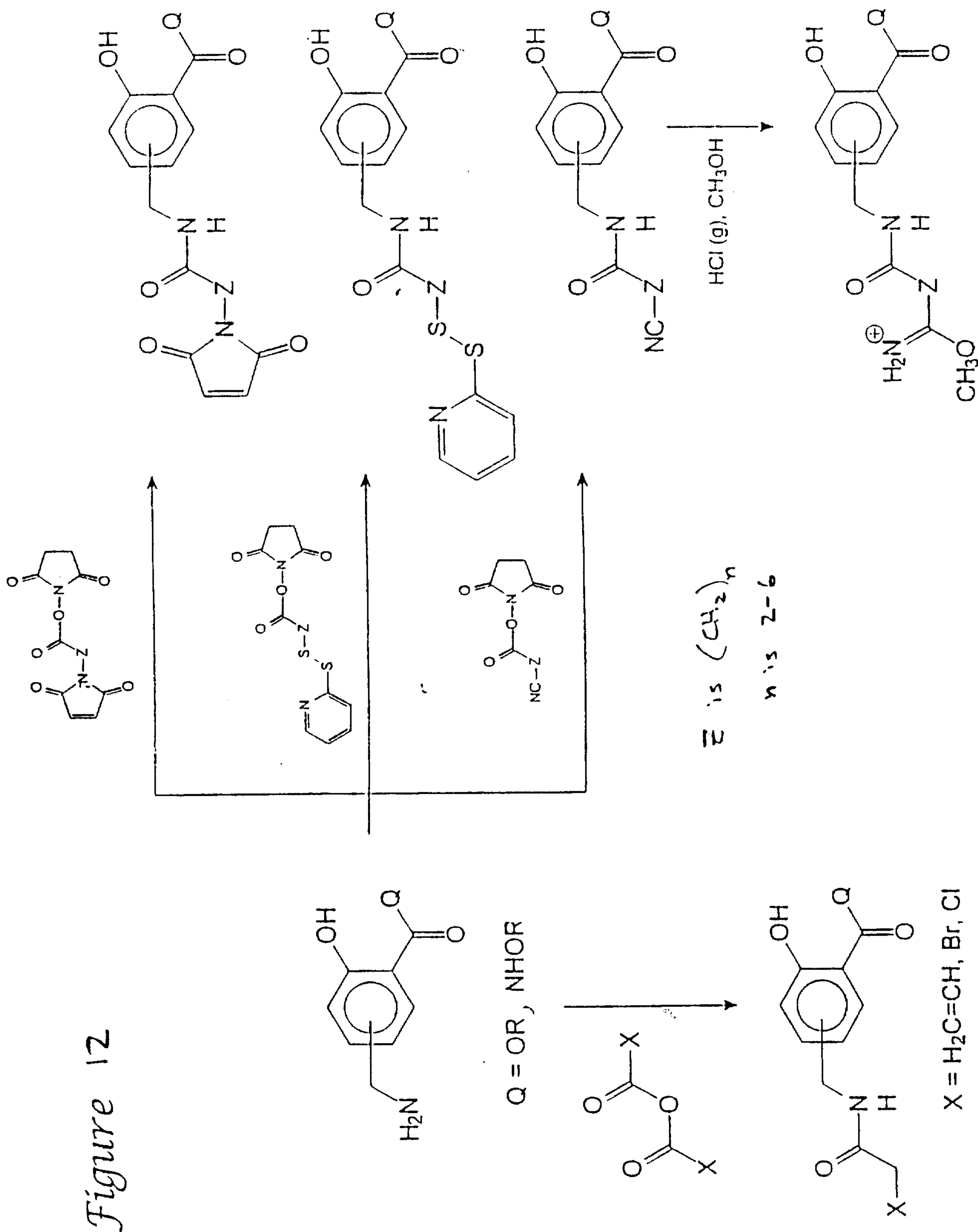
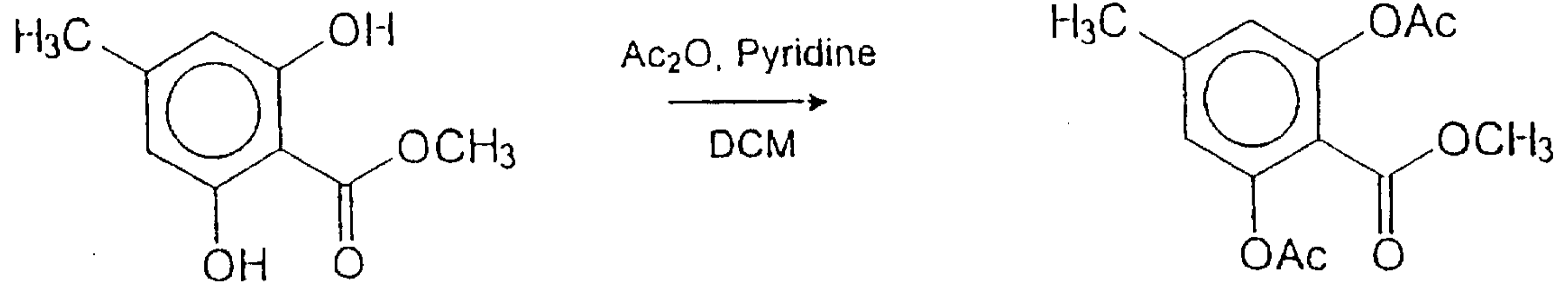

Figure 12

13/21

## Figure 13

Step 1



Step 2

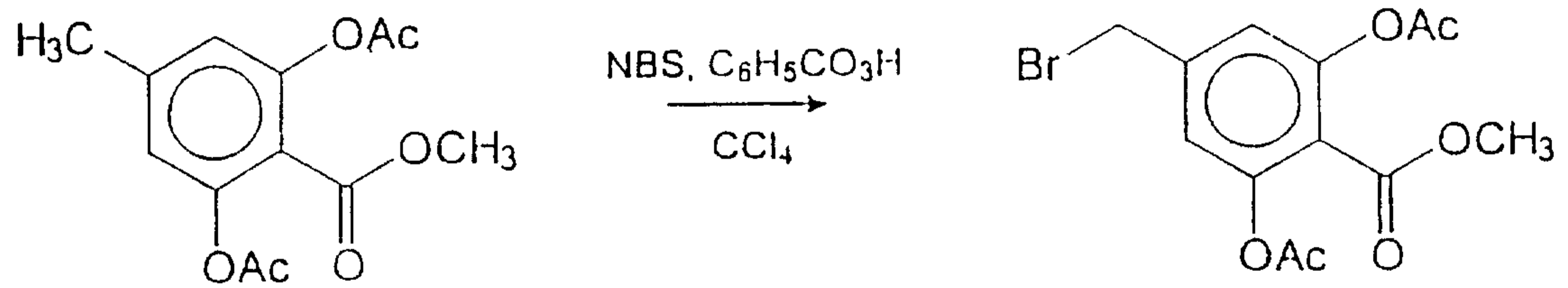

Step 3

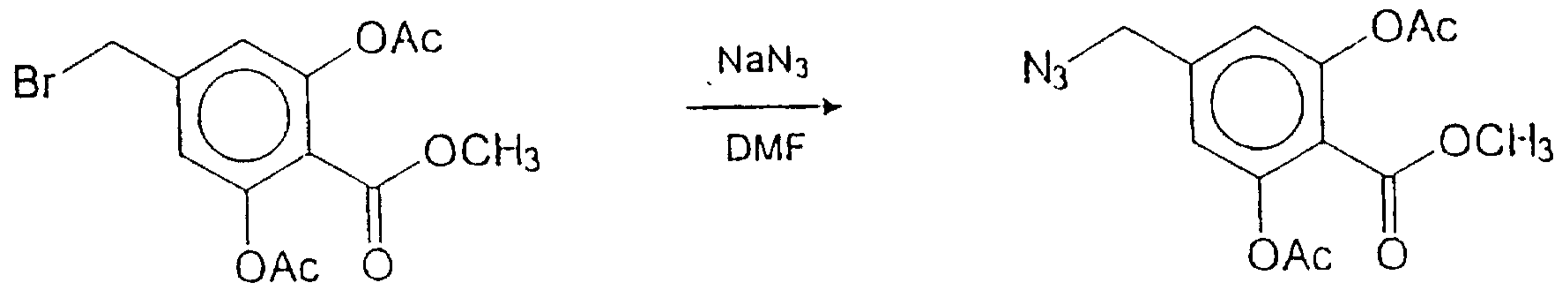

Step 4

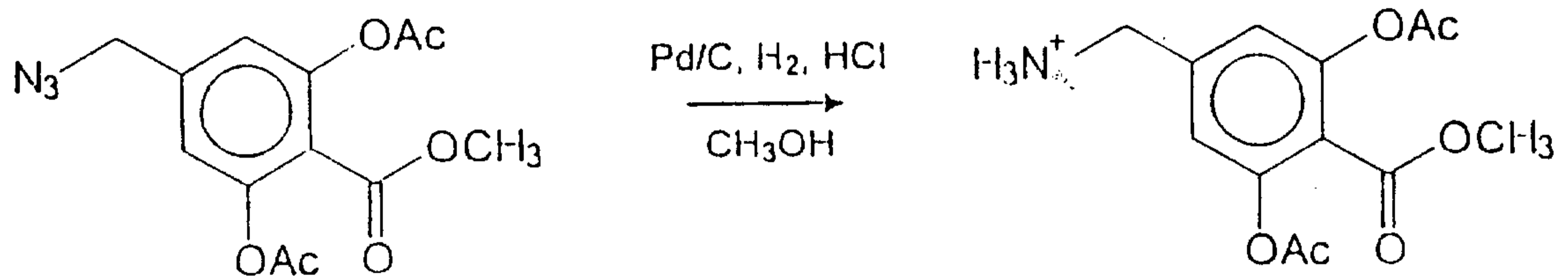

Step 5

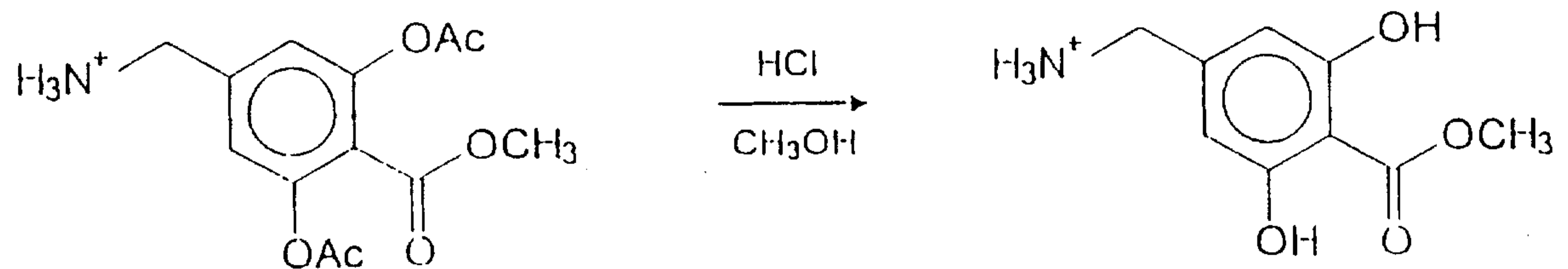

14/21

## Figure 14

Step 1

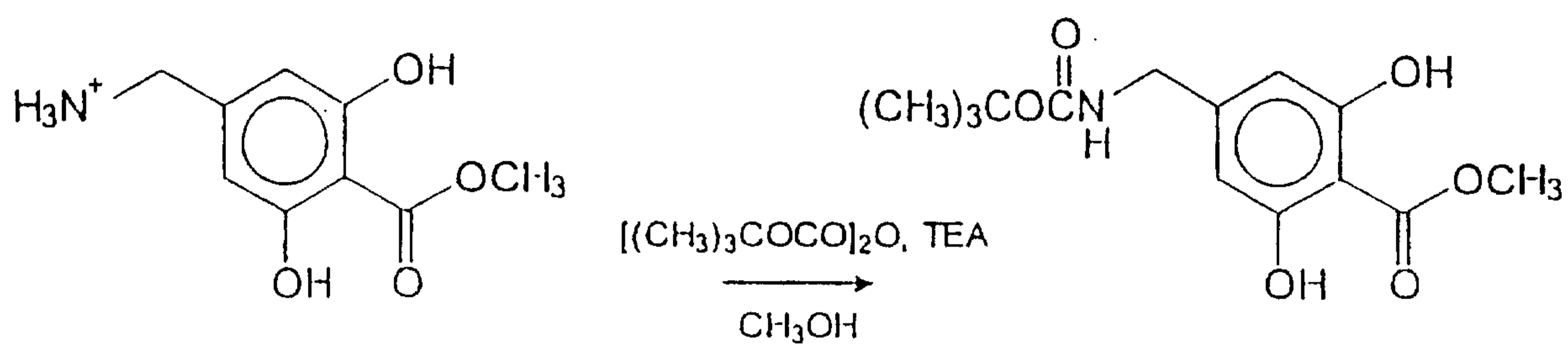

Step 2

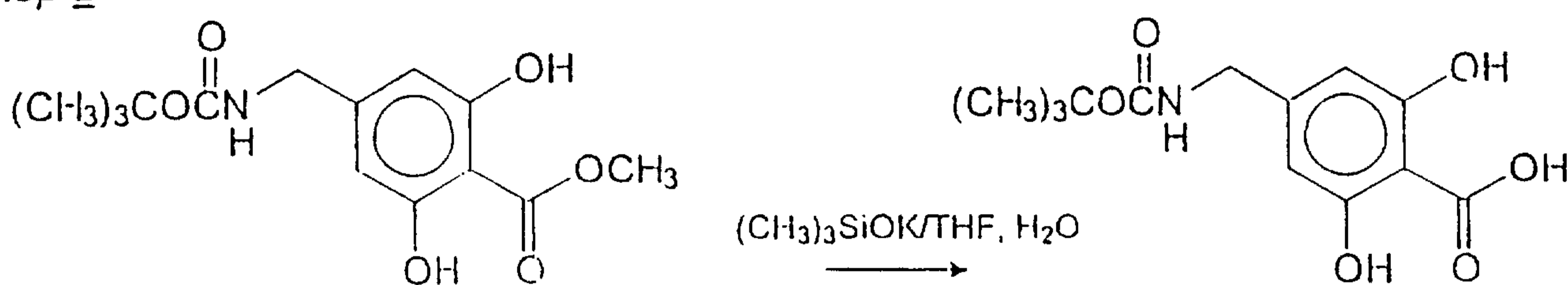

Step 3



Step 4

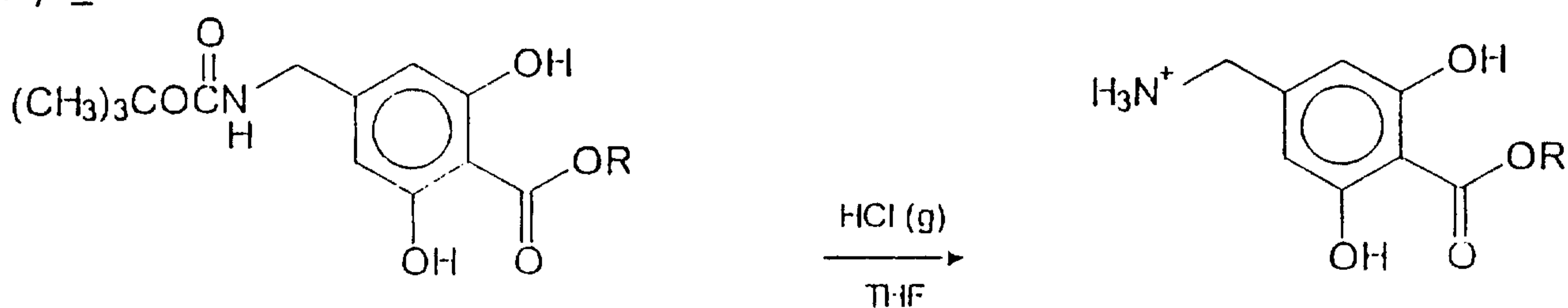

15/21

## Figure 15

Step 1

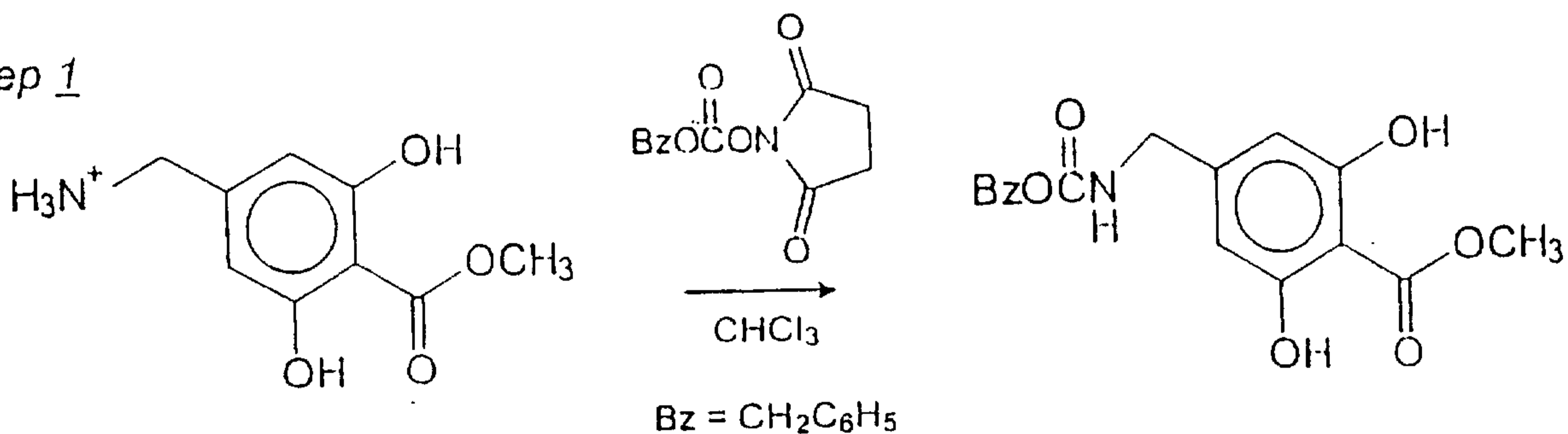

Step 2

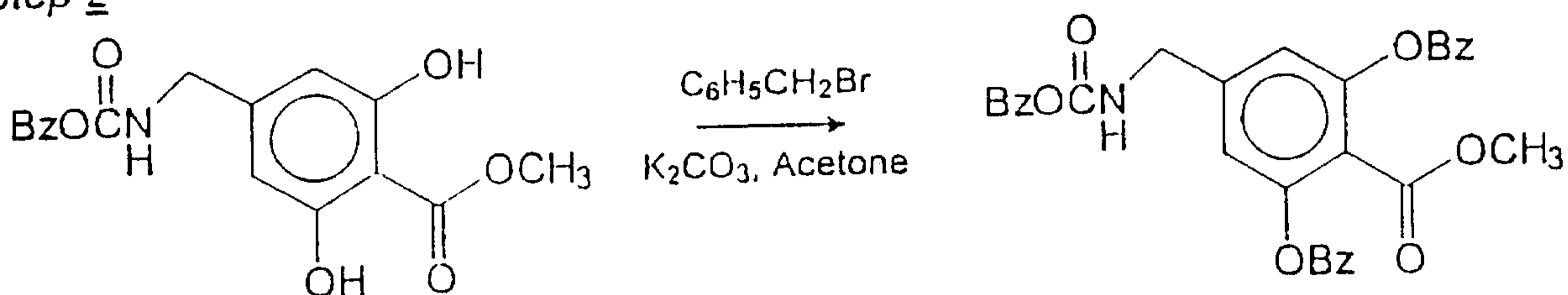

Step 3

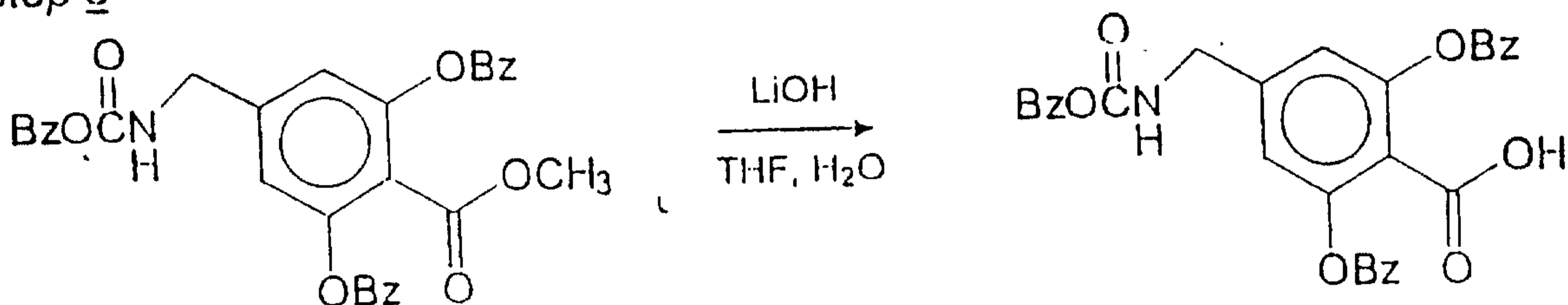

Step 4

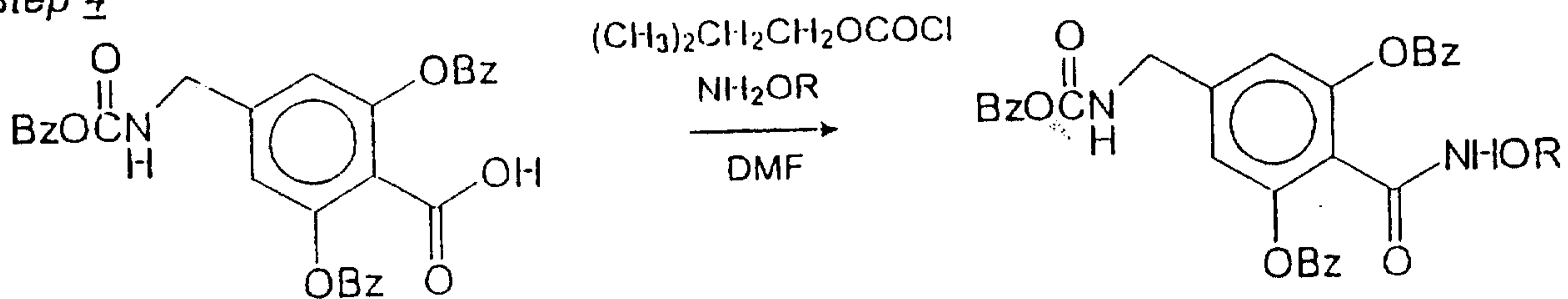

Step 5

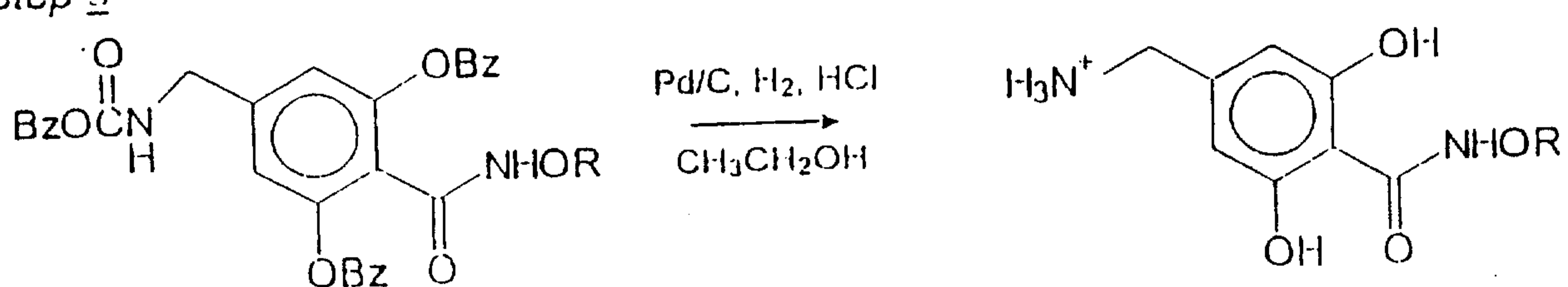
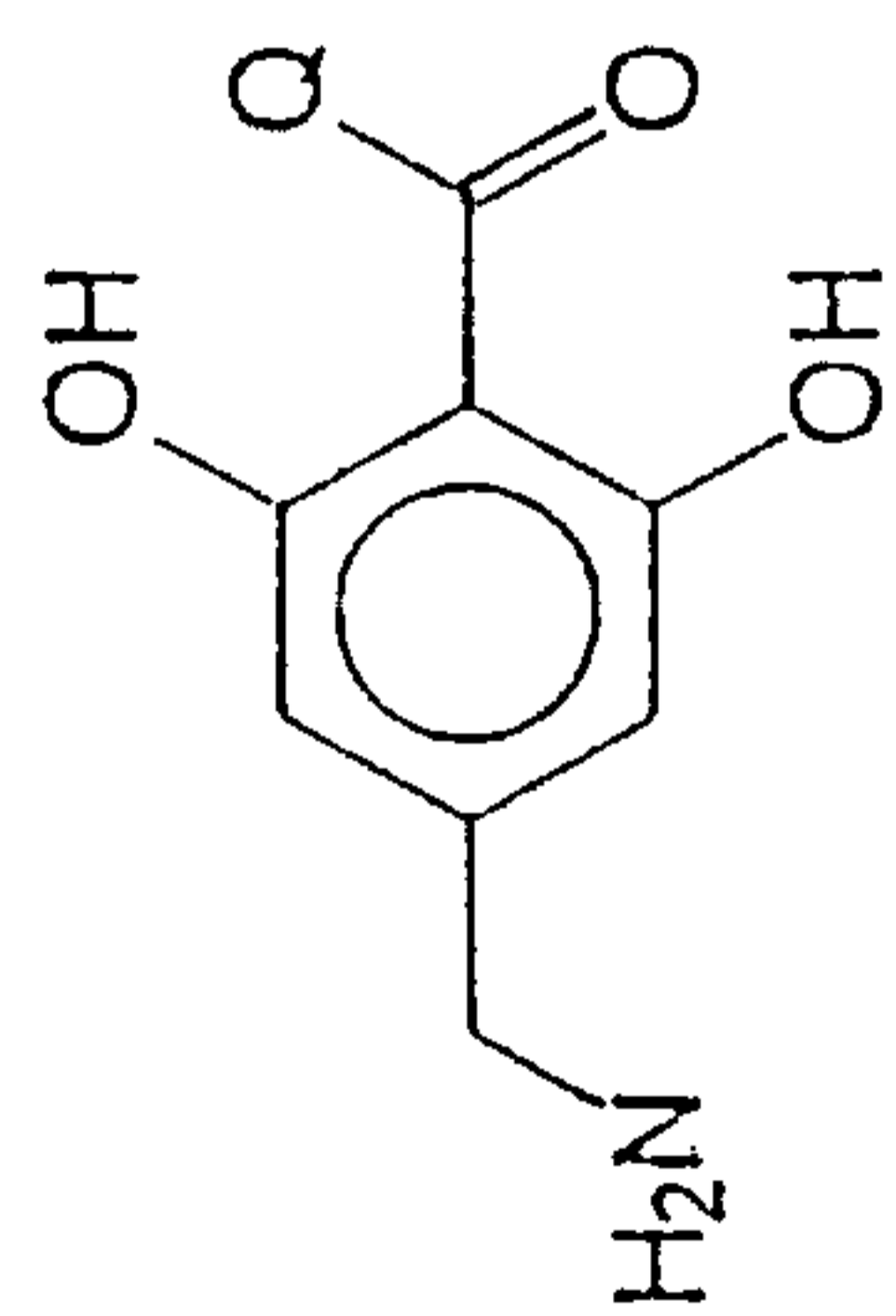
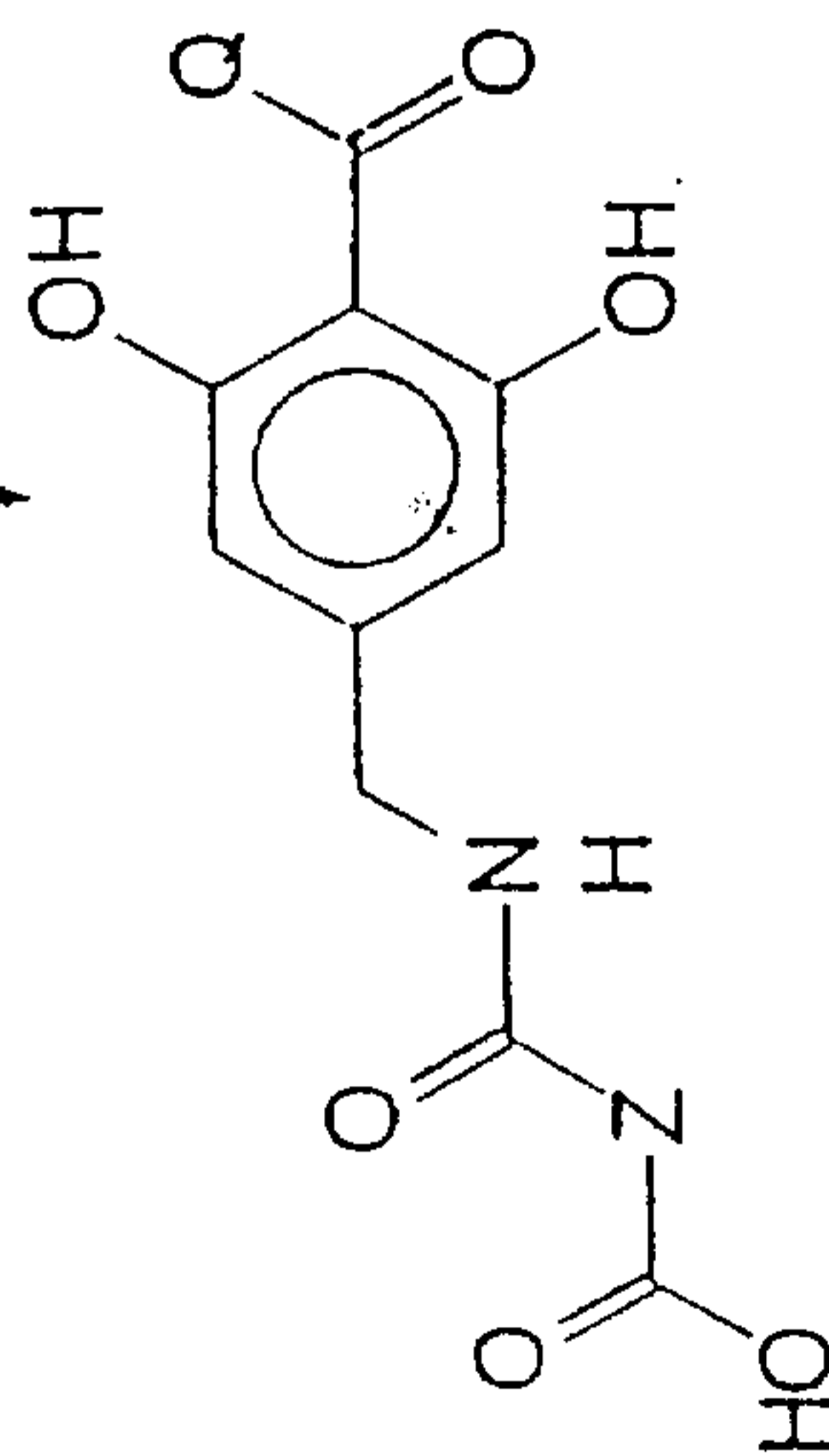
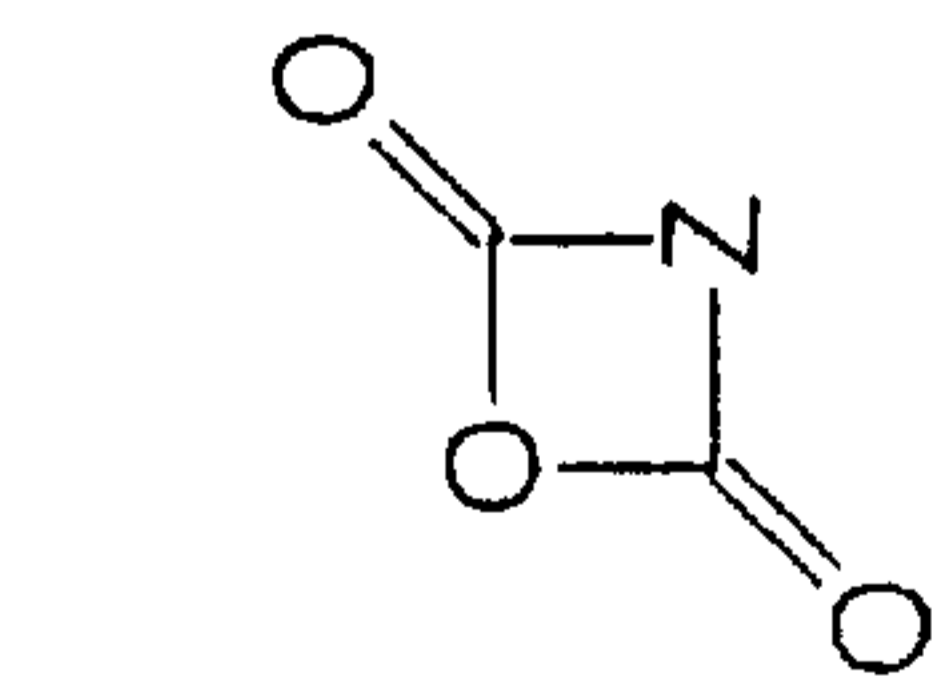

Figure 16



Q = OR, NHOR



Z is (CH<sub>2</sub>)<sub>n</sub>  
n is 2-6

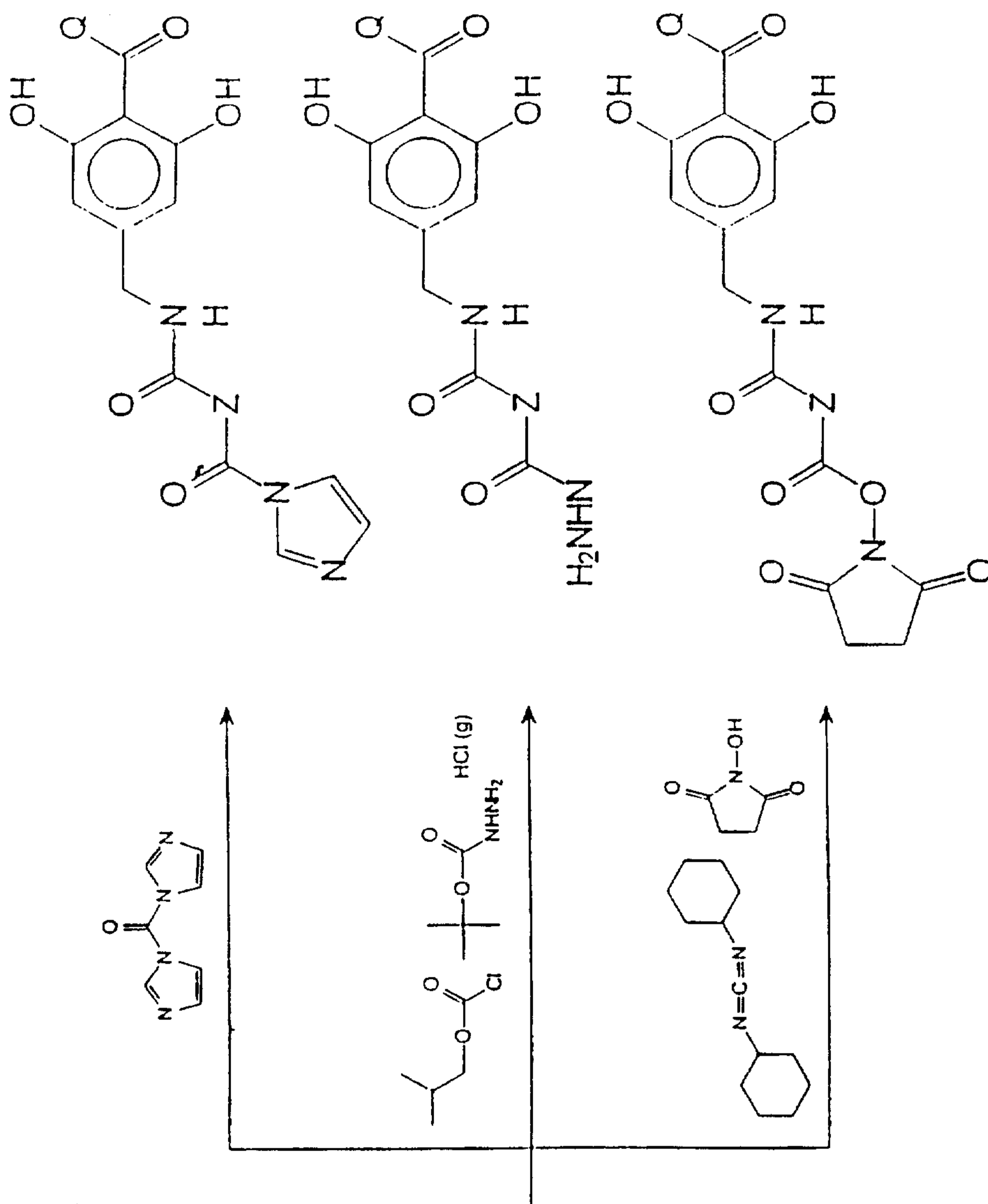

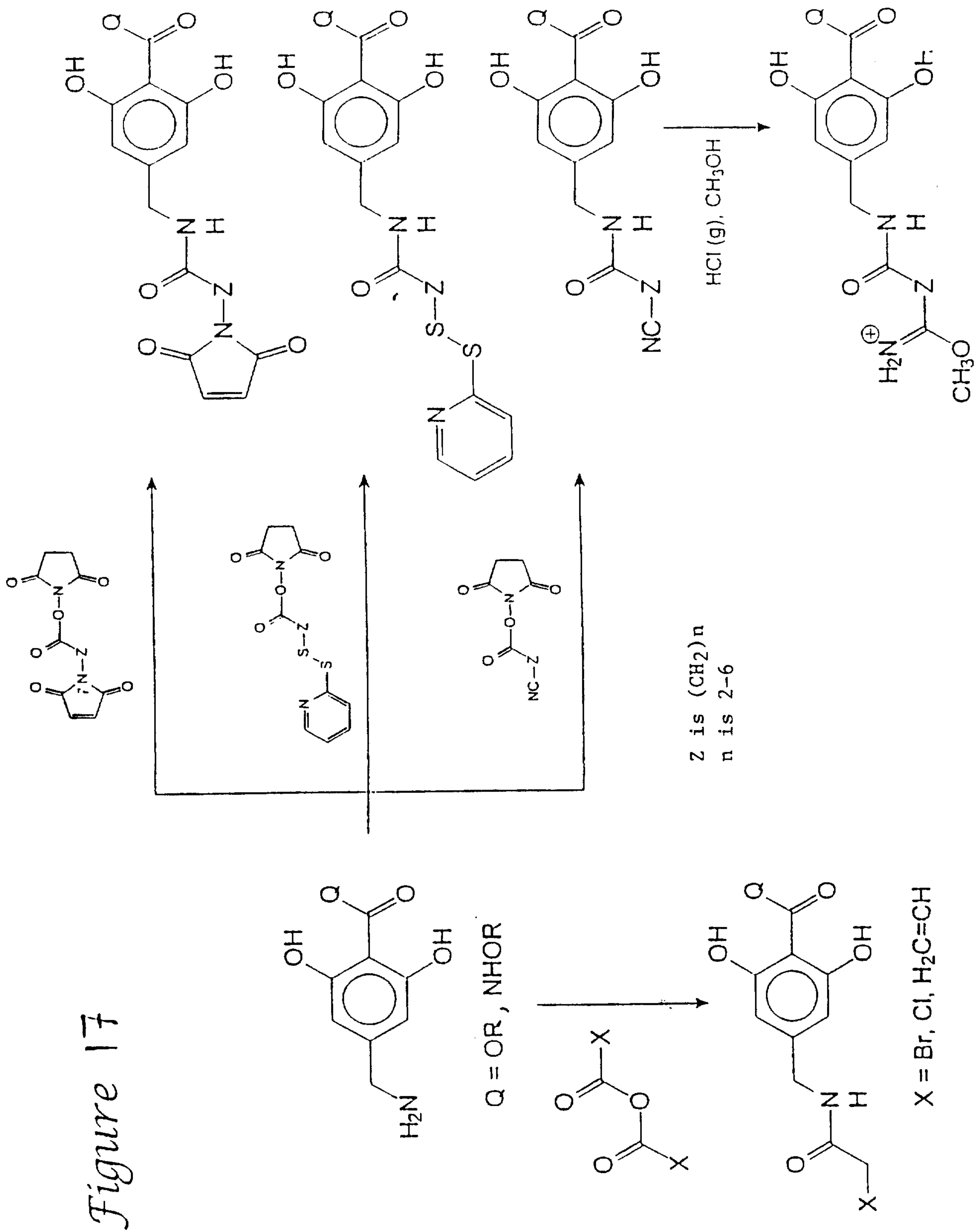

18/21

Figure 18

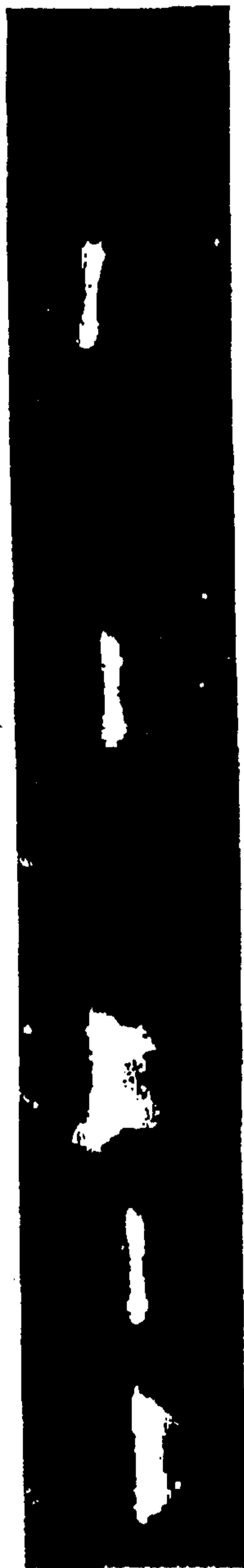
*Taq Polymerase Incorporation of PBA-XX-dUTP*

- 1 dTTP Control
- 2 dTTP after DHBHA-Sepharose
- 3 3:1 PBA-XX-dUTP/dTTP
- 4 3:1 PBA-XX-dUPT/dTTP after DHBHA-Sepharose
- 5 3:1 PBA-X-dUTP/dTTP
- 6 3:1 PBA-X-dUTP/dTTP after DHBHA-Sepharose
- 7 5:1 PBA-XX-dUTP/dTTP
- 8 5:1 PBA-XX-dUTP/dTTP after DHBHA-Sepharose

Figure 19

*Taq Polymerase Incorporation of PBA-XX-dUTP*

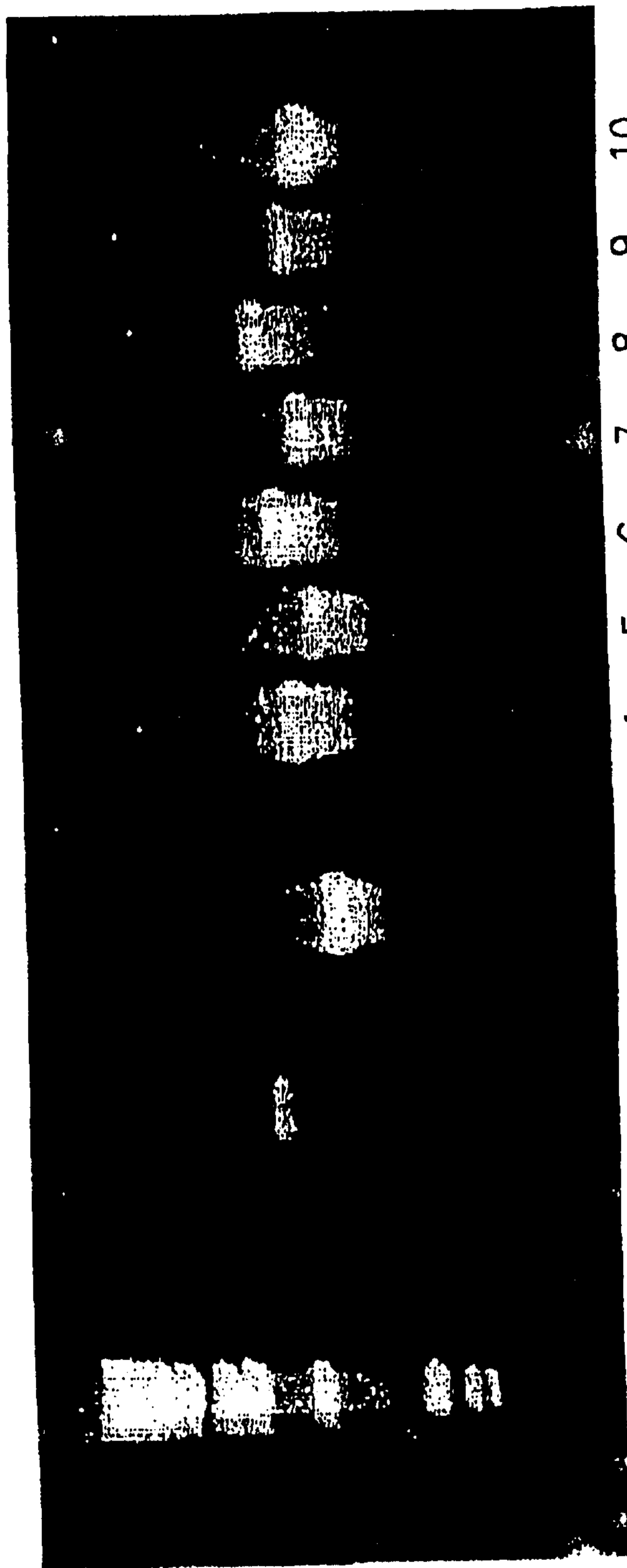

- |   |                      |    |                       |
|---|----------------------|----|-----------------------|
| 1 | 1Kb Ladder           | 6  | 5:1 PBA-XX-dUTP/dTTP  |
| 2 | PBA-XX-dUTP          | 7  | 5:1 PBA-X-dUTP/dTTP   |
| 3 | dTTP                 | 8  | 10:1 PBA-XX-dUTP/dTTP |
| 4 | 3:1 PBA-XX-dUTP/dTTP | 9  | 10:1 PBA-X-dUTP/dTTP  |
| 5 | 3:1 PBA-X-dUTP/dTTP  | 10 | dTTP with PBA-Primer  |



Figure 20

*Random Primed Labeling Incorporation of PBA-XX-dUTP*

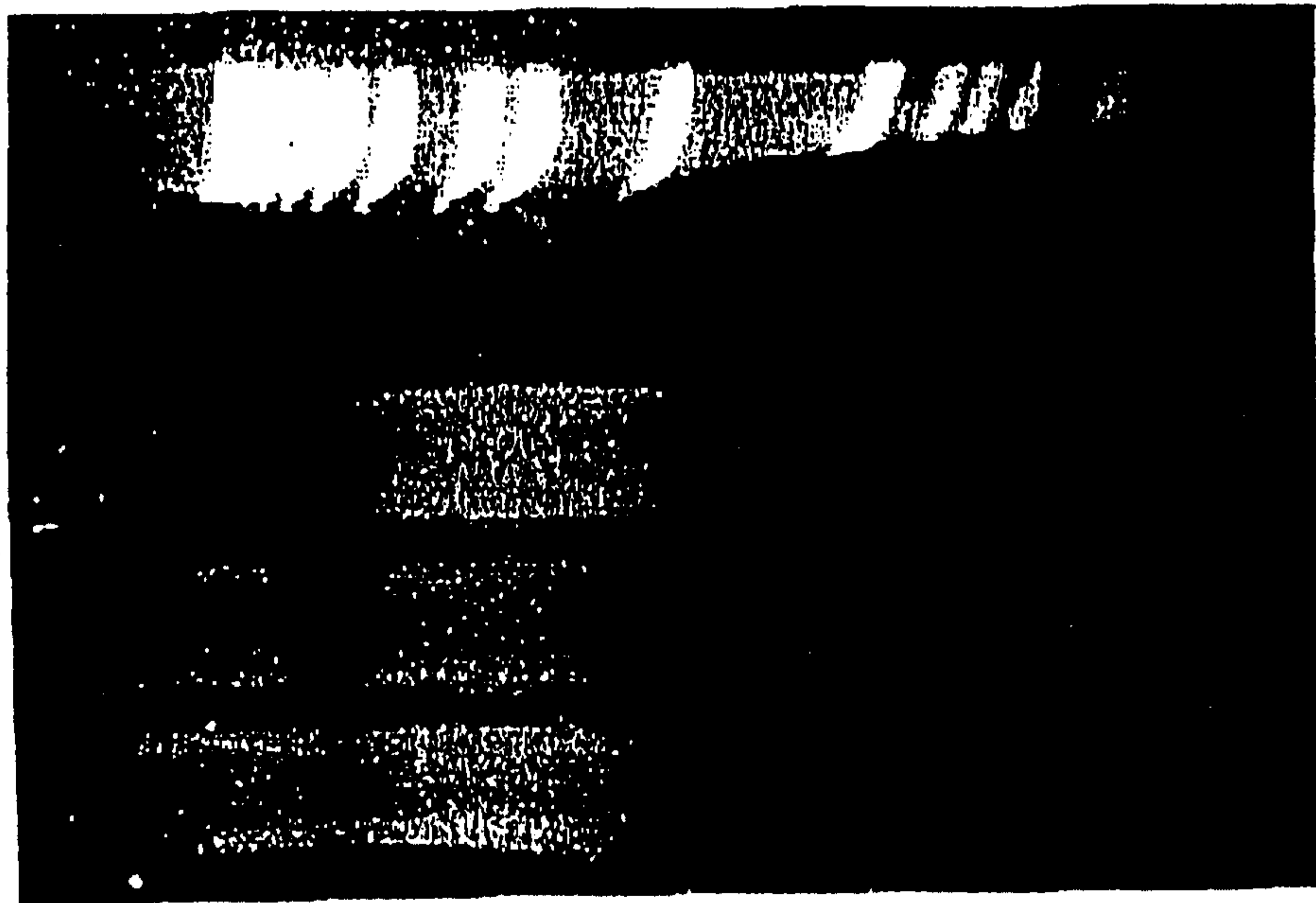

1 dTTP Control

2 dTTP after DHBHA-Separose

3 PBA-XX-dUTP Control

4 PBA-XX-dUTP after DHBHA-Separose

5 1Kb Ladder

Figure 21

*Terminal Transferase Incorporation of PBA-XX-dUTP*

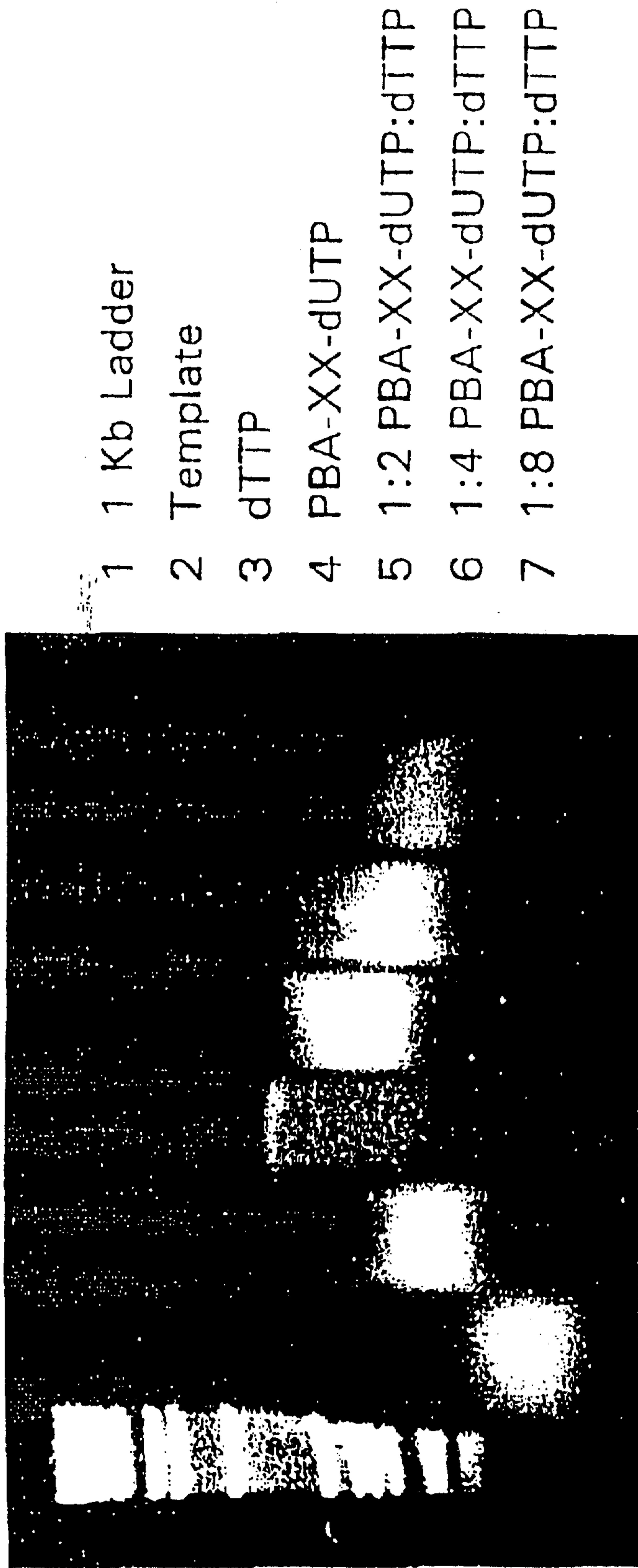

1 2 3 4 5 6 7

