



US00D770670S

(12) **United States Design Patent**
Reynolds

(10) **Patent No.:** **US D770,670 S**

(45) **Date of Patent:** **** Nov. 1, 2016**

(54) **HORTICULTURE GROW LIGHT**

(71) Applicant: **IP Holdings, LLC**, Vancouver, WA
(US)

(72) Inventor: **Christopher Reynolds**, Vancouver, WA
(US)

(73) Assignee: **IP Holdings, LLC**, Vancouver, WA
(US)

(**) Term: **15 Years**

(21) Appl. No.: **29/531,242**

(22) Filed: **Jun. 24, 2015**

(51) **LOC (10) Cl.** **29-99**

(52) **U.S. Cl.** **D26/118**
USPC **D26/118**

(58) **Field of Classification Search**
USPC D26/9, 10, 12, 13, 15, 16, 24, 51, 61,
D26/72, 76, 80, 81, 85, 86, 88, 90, 113, 118,
D26/119, 120, 122, 128, 129, 138, 143, 144
CPC B60Q 1/04; B60Q 1/26; F21S 8/026;
F21S 8/04; F21V 29/004; F21V 21/02;
F21V 21/04; F21V 29/2212; F21V 7/22;
F21V 29/83; F21V 37/002; F21V 7/00;
F21L 19/00; F23D 11/443; F21Y 2101/02;
A61L 9/037

See application file for complete search history.

(56) **References Cited**

U.S. PATENT DOCUMENTS

1,798,567 A 3/1931 Wagenhorst
1,987,705 A 1/1935 Pedersen

(Continued)

FOREIGN PATENT DOCUMENTS

CA 2034710 A1 8/1991
CA 1314529 C 3/1993

(Continued)

OTHER PUBLICATIONS

Air Resistance: Distinguishing Between Laminar and Turbulent Flow, www.docstoc.com, Dec. 29, 2010, p. 1-6.

(Continued)

Primary Examiner — Brian N Vinson

(74) *Attorney, Agent, or Firm* — J. Douglas Wells

(57)

CLAIM

The ornamental design for a horticulture grow light, as shown and described.

DESCRIPTION

FIG. 1 is a perspective view of a horticulture grow light, as viewed from below, showing my new design;

FIG. 2 is a perspective view of the light shown in FIG. 1, as viewed from above;

FIG. 3 is a left side view of the light shown in FIG. 1;

FIG. 4 is a right side view of the light shown in FIG. 1;

FIG. 5 is a front elevation view of the light shown in FIG. 1;

FIG. 6 is a rear elevation view of the light shown in FIG. 1; FIG. 7 is a bottom plan view of the light shown in FIG. 1; FIG. 8 is a top plan view of the light shown in FIG. 1; FIG. 9 is a partial bottom plan view of the light as shown in FIGS. 1 and 7, showing a reflector portion of such light, with corner sections dash-lined for a smooth mirror reflective surface, and with central portions stippled for a non-smooth textured reflective surface;

FIG. 10 is a partial bottom plan view of the light as shown in FIGS. 1 and 7, showing a reflector portion of such light, with corner sections stippled for a non-smooth textured reflective surface, and with central portions dash-lined for a smooth mirror reflective surface;

FIG. 11 is a partial bottom plan view of the light as shown in FIGS. 1 and 7, showing a reflector portion of such light, with corner sections single cross-hatched for a contrasted reflective surface, and with central portions double-triple cross-hatched for a reflective surface; and,

FIG. 12 is a partial bottom plan view of the light as shown in FIGS. 1 and 7, showing a reflector portion of such light, with dash-lined for a smooth mirror reflective surface.

The broken-line disclosure shown in the views is understood to represent portions of the article in which the claimed design is embodied, but which form no part of the claimed design.

1 Claim, 10 Drawing Sheets

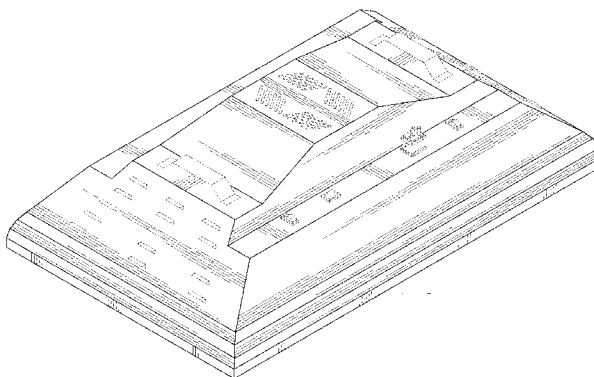
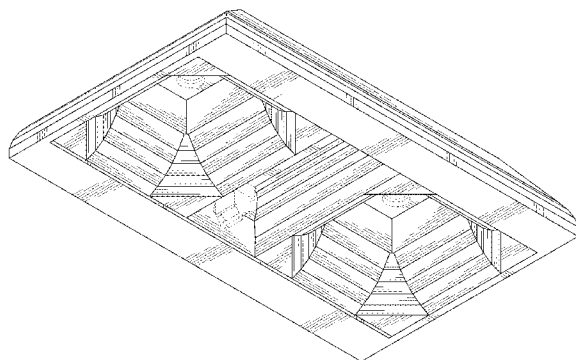

(56)

References Cited

U.S. PATENT DOCUMENTS

D106,614 S	10/1937	Waterbury	6,595,662 B2	7/2003	Wardenburg	
D123,768 S	12/1940	Scribner	6,601,972 B2	8/2003	Sei et al.	
D125,559 S	3/1941	Biller	6,658,652 B1	12/2003	Alexander	
D156,014 S	11/1949	Lazerson	6,709,131 B1	3/2004	Herst	
D174,221 S	3/1955	Hatch	6,729,383 B1	5/2004	Cannell et al.	
2,740,883 A	4/1956	Kruger	6,783,263 B1	8/2004	Cronk	
2,998,511 A	8/1961	Kingsley Chan	D496,121 S	9/2004	Santoro	
3,025,391 A	3/1962	Golko	6,885,134 B2	4/2005	Kurashima et al.	
3,125,301 A	3/1964	Stotter	7,156,539 B2	1/2007	Cronk	
3,272,978 A	9/1966	Jackson	7,175,309 B2	2/2007	Craw et al.	
3,420,995 A	1/1969	Dunckel	D542,460 S	5/2007	Hargreaves	
3,433,941 A	3/1969	Hall	D543,652 S *	5/2007	Hargreaves	D26/118
3,675,008 A	7/1972	Hill	D543,654 S	5/2007	Hargreaves	
3,701,898 A	10/1972	McNamara	7,213,948 B2	5/2007	Hein	
3,755,667 A	8/1973	Price	D544,136 S	6/2007	Hargreaves	
3,902,059 A	8/1975	McNamara	D544,138 S	6/2007	Hargreaves	
4,078,169 A	3/1978	Armstrong	D544,139 S	6/2007	Hargreaves	
D259,738 S	6/1981	Boschetti	D544,626 S	6/2007	Hargreaves	
D262,659 S	1/1982	Lalita	D544,980 S	6/2007	Hargreaves	
D266,578 S	10/1982	Moshier	D544,981 S	6/2007	Hargreaves	
4,531,180 A	7/1985	Hernandez	D544,982 S	6/2007	Hargreaves	
4,669,033 A	5/1987	Lee	D544,983 S	6/2007	Hargreaves	
D300,877 S	4/1989	Cyr	D544,984 S	6/2007	Hargreaves	
4,933,821 A	6/1990	Anderson	D544,985 S	6/2007	Hargreaves	
4,939,629 A	7/1990	Glanton et al.	D544,987 S	6/2007	Hargreaves	
D311,597 S	10/1990	Poot	D544,994 S	6/2007	Hargreaves	
4,970,428 A	11/1990	Hayakawa et al.	D544,995 S *	6/2007	Hargreaves	D26/118
4,980,809 A	12/1990	Baldwin et al.	D545,484 S *	6/2007	Hargreaves	D26/118
5,065,294 A	11/1991	Poot, Jr.	D545,485 S *	6/2007	Hargreaves	D26/118
5,072,349 A	12/1991	Waniga	D545,994 S	7/2007	Hargreaves	
5,253,152 A	10/1993	Yang	7,296,914 B1	11/2007	Russello	
5,353,746 A	10/1994	Del Rosario	7,360,927 B2	4/2008	Oka	
D352,126 S	11/1994	Ruud	7,445,363 B2	11/2008	Vanden Eynden	
5,461,554 A	10/1995	Leonetti et al.	7,524,090 B2	4/2009	Hargreaves	
5,486,737 A	1/1996	Hrubowchak et al.	7,534,011 B2	5/2009	Townsley	
5,510,676 A	4/1996	Cottaar et al.	D595,894 S	7/2009	Verfuert	
5,555,162 A	9/1996	Shemitz	D603,087 S	10/2009	Mo et al.	
5,570,947 A	11/1996	Felland	7,617,057 B2	11/2009	May et al.	
D377,993 S	2/1997	Herst	7,641,367 B2	1/2010	Hargreaves et al.	
5,698,947 A	12/1997	Choi	7,654,702 B1	2/2010	Ding	
D391,632 S	3/1998	Thomas	D614,801 S *	4/2010	Collins	D26/118
D396,319 S	7/1998	Sutton	7,722,228 B2	5/2010	Broer	
D397,481 S	8/1998	Schafer	D617,028 S	6/2010	Verfuert	
D399,329 S	10/1998	Compton	7,771,086 B2	8/2010	Goverde	
D399,587 S	10/1998	Compton	7,854,534 B2	12/2010	Liu	
5,896,004 A	4/1999	Feldman et al.	D633,640 S	3/2011	Wauters	
5,924,789 A	7/1999	Thornton	D634,060 S *	3/2011	Wardenburg	D26/118
5,932,955 A	8/1999	Berger et al.	D634,240 S	3/2011	Junkeer	
5,983,564 A	11/1999	Stragnola	D634,468 S	3/2011	Hargreaves	
5,987,697 A	11/1999	Song et al.	D634,469 S *	3/2011	Hargreaves	D26/118
5,999,943 A	12/1999	Nori	D637,341 S	5/2011	Wardenburg	
D418,626 S	1/2000	Herst	D637,752 S	5/2011	Mekhtarian	
D419,248 S	1/2000	Lyons	7,959,331 B2	6/2011	Ho	
6,024,468 A	2/2000	Kassay	7,972,044 B2	7/2011	Burkhauser	
6,042,250 A	3/2000	Stragnola	7,987,632 B2	8/2011	May et al.	
6,051,927 A	4/2000	Graser et al.	8,018,630 B2	9/2011	Herloski	
D425,237 S	5/2000	Scott	D648,652 S	11/2011	Hawkins	
6,061,690 A	5/2000	Nori	D650,515 S	12/2011	Bradley	
6,065,849 A	5/2000	Chen	D661,833 S	6/2012	Imajo	
6,070,173 A	5/2000	Huber	8,209,912 B2	7/2012	Hargreaves et al.	
6,076,944 A	6/2000	Maranon	D667,584 S	9/2012	Beghelli	
D428,516 S *	7/2000	Reo	8,334,640 B2	12/2012	Reed et al.	
6,094,919 A	8/2000	Bhatia	D675,369 S *	1/2013	Michaud	D26/118
6,111,739 A	8/2000	Wu et al.	8,371,726 B2	2/2013	Collins et al.	
6,152,579 A	11/2000	Reed et al.	D678,599 S	3/2013	Boyer et al.	
6,230,497 B1	5/2001	Morris et al.	D679,848 S	4/2013	Pickard	
D447,272 S *	8/2001	Smith	D683,064 S	5/2013	Tuck	
6,279,012 B1	8/2001	Sexton	D693,959 S *	11/2013	Boyer	D26/118
6,343,984 B1	2/2002	Langdon et al.	D698,074 S	1/2014	Hargreaves	
6,371,630 B1	4/2002	Unger	D698,986 S *	2/2014	Reynolds	D26/118
D456,938 S *	5/2002	Wardenburg	D698,987 S	2/2014	Stanley	
D459,825 S	7/2002	Field	D699,386 S	2/2014	Park	
6,488,387 B2	12/2002	Wardenburg	8,702,283 B2	4/2014	Bradley	
D469,564 S	1/2003	Brok	D705,474 S	5/2014	Philips	
6,527,422 B1	3/2003	Hutchison	8,723,086 B2	5/2014	McMahan	
			D707,385 S	6/2014	Wardenburg	
			D710,528 S	8/2014	Wardenburg	
			D717,636 S	11/2014	Stanley	
			D720,505 S	12/2014	Kersten	

(56)

References Cited

U.S. PATENT DOCUMENTS

8,905,575 B2 * 12/2014 Durkee F21V 7/0008
362/218

D725,820 S 3/2015 Hargreaves

9,016,907 B2 4/2015 Stanley

D728,848 S 5/2015 Reyes

D731,701 S * 6/2015 Hargreaves D26/118

D732,235 S * 6/2015 Reynolds D26/118

D732,236 S * 6/2015 Reynolds D26/118

D735,391 S 7/2015 Blessitt

D735,401 S 7/2015 Clements

D736,450 S * 8/2015 Reynolds D26/118

D737,498 S 8/2015 Stanley

9,110,209 B2 8/2015 Blessitt

D738,031 S 9/2015 Martins

D739,595 S 9/2015 Reynolds

9,127,826 B2 9/2015 Boyer

D740,486 S * 10/2015 Stanley D26/118

D745,993 S 12/2015 Reynolds

D747,029 S * 1/2016 Reynolds D26/118

D748,849 S * 2/2016 Stanley D26/118

D750,316 S * 2/2016 Reynolds D26/118

D751,244 S * 3/2016 Reynolds D26/118

D751,247 S * 3/2016 Reynolds D26/118

D756,026 S 5/2016 Reynolds

2002/0073285 A1 6/2002 Butterworth

2003/0191783 A1 10/2003 Wolczko

2005/0117333 A1 6/2005 Yoshida

2005/0160481 A1 7/2005 Todd

2005/0233691 A1 10/2005 Horton

2006/0231081 A1 10/2006 Kirakosyan

2006/0232984 A1 10/2006 Schuknecht

2006/0282457 A1 12/2006 Williams

2007/0051321 A1 3/2007 Chang

2007/0070633 A1 3/2007 Eynden

2007/0228993 A1 10/2007 Stuer et al.

2007/0246631 A1 10/2007 Brown

2007/0282806 A1 12/2007 Hoffman

2008/0059799 A1 3/2008 Scarlata

2008/0117617 A1 5/2008 Hargreaves et al.

2008/0205030 A1 8/2008 Hargreaves

2008/0205071 A1 8/2008 Townsley

2008/0212326 A1 9/2008 Chon

2008/0278950 A1 11/2008 Pickard et al.

2009/0231840 A1 9/2009 Boehme et al.

2009/0262540 A1 10/2009 Hargreaves et al.

2009/0276478 A1 11/2009 Soman

2009/0310373 A1 12/2009 Burkhauser

2009/0316404 A1 12/2009 Mo

2009/0323335 A1 12/2009 Yang

2010/0214789 A1 8/2010 Hawkes

2010/0238661 A1 9/2010 Pfund

2010/0277929 A1 11/2010 Hargreaves

2010/0302768 A1 12/2010 Collins et al.

2011/0169412 A1 7/2011 Yurich

2012/0092859 A1 4/2012 Gregoris

2012/0230035 A1 9/2012 Bradley, Jr. et al.

2013/0083539 A1 4/2013 Dimitriadis

2013/0155685 A1 6/2013 Stanley

2013/0242573 A1 9/2013 Petsoki

2013/0250567 A1 9/2013 Edmond

2015/0252992 A1 9/2015 Stanley

2015/0252993 A1 9/2015 Stanley

2015/0252994 A1 9/2015 Stanley

FOREIGN PATENT DOCUMENTS

EP 0325003 A1 7/1989

EP 0440274 A1 8/1991

WO 02063210 A2 8/2002

WO 2008018000 A1 2/2008

WO 2009096775 A2 8/2009

WO 2011119451 A1 9/2011

WO 2015009333 1/2015

OTHER PUBLICATIONS

Sun Systems LEC 630 Light Emitting Ceramic Fixture, Spec Sheet for 906217—Sun System LEC 630 120 Volt w/ 3100 K Lamps, www.sunlightsupply.com/shop/bycategory/led-lighting/sun-system-lec-630-light-emitting-ceramic-fixture, online, updated Feb. 9, 2015. Site visited Mar. 30, 2015, p. 1.

Mohri, Mineko, International Preliminary Report on Patentability for PCT/US2014/014959, Jan. 19, 2016.

A3V Reflector, Titaness Light Shop, www.titanesslightshop.com/products-page/reflectors/a3v-reflector, online. Site visited Jan. 14, 2015.

G2V Grow Light Reflector, Titaness Light Shop, www.titanesslightshop.com/products-page/reflectors/g2v-grow-light-reflector, online. Site visited Jan. 14, 2015.

* cited by examiner

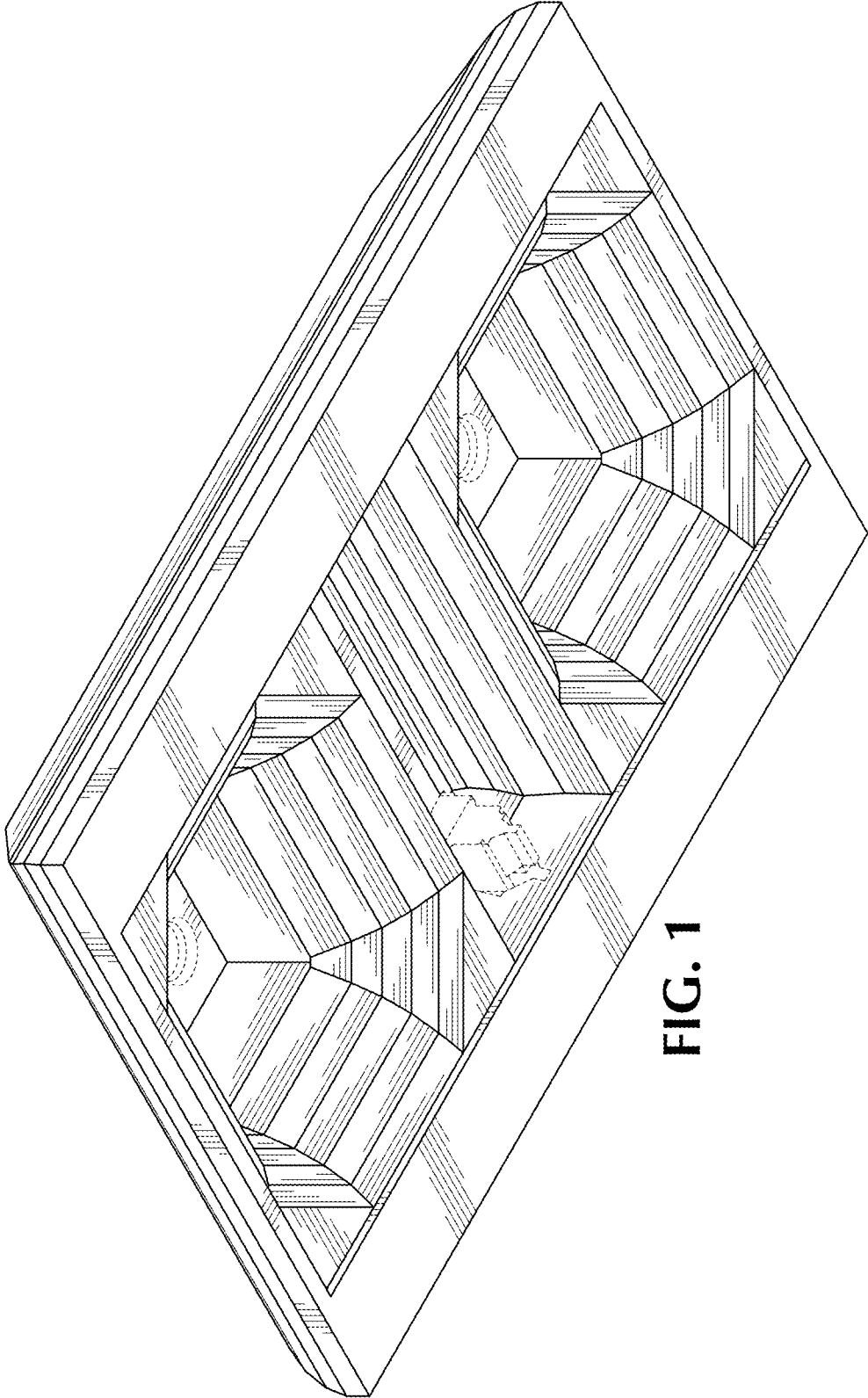

FIG. 1

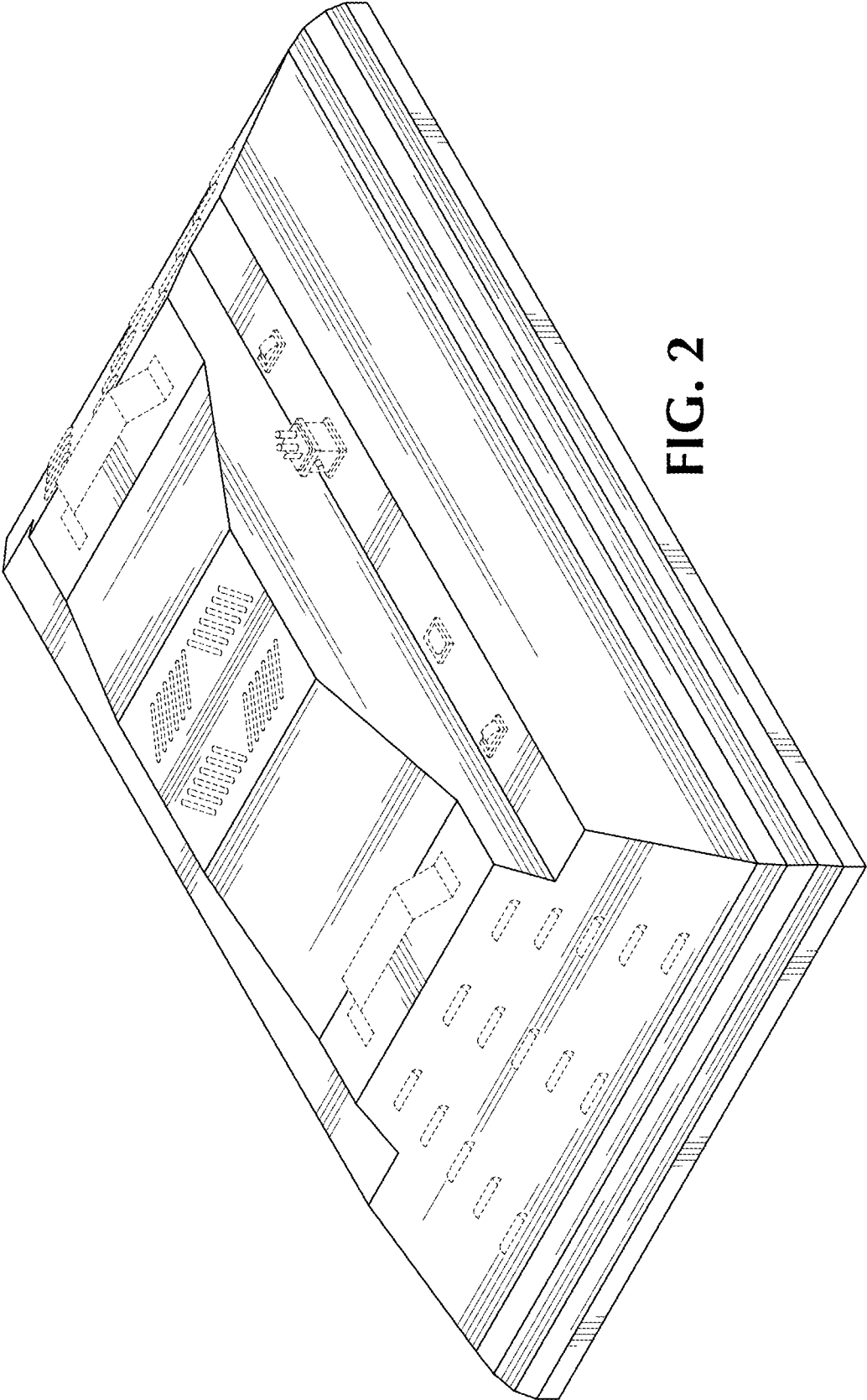

FIG. 2

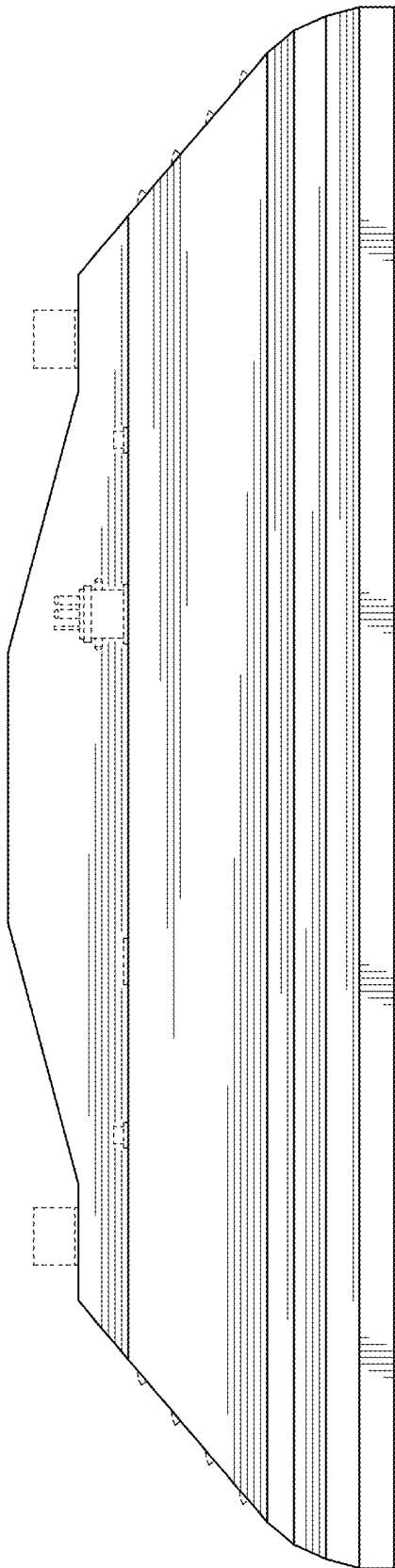

FIG. 3

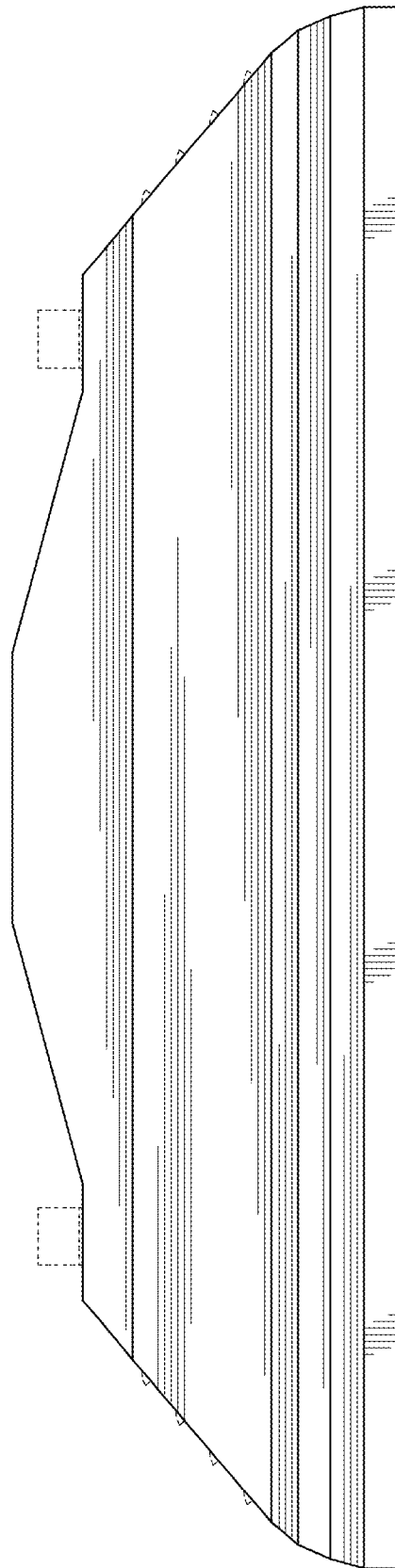

FIG. 4

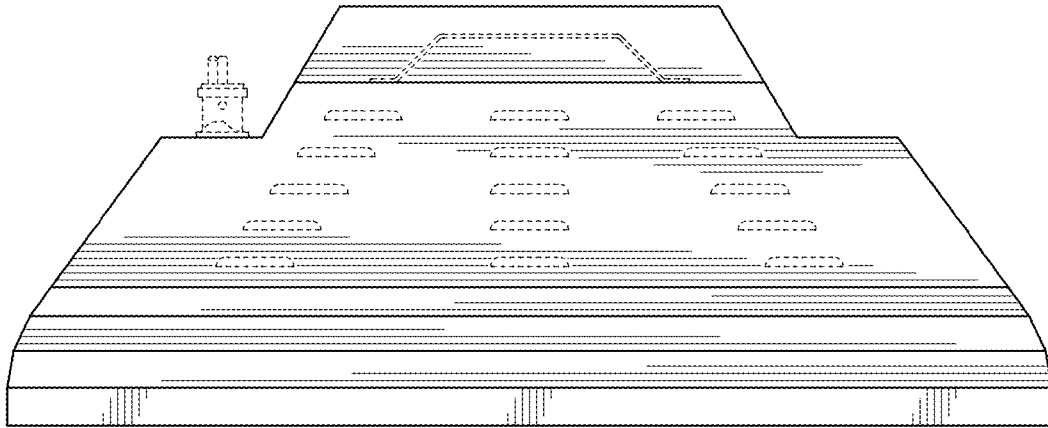

FIG. 5

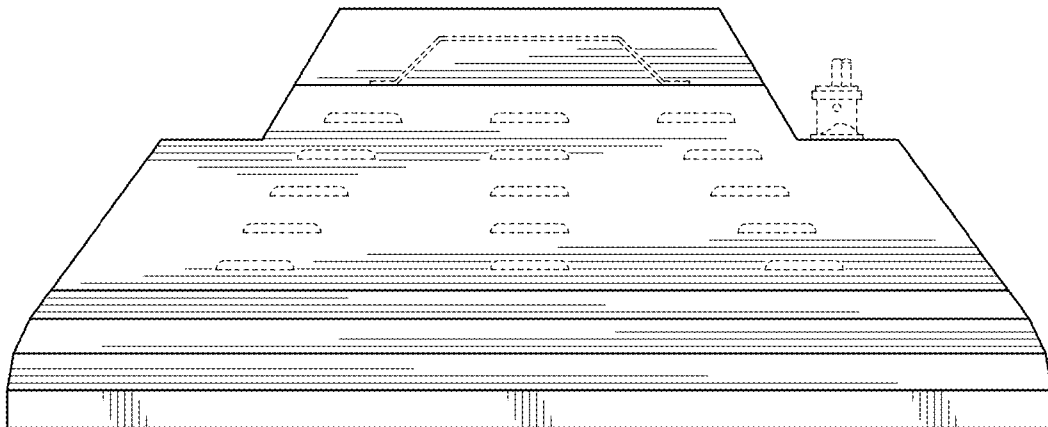

FIG. 6

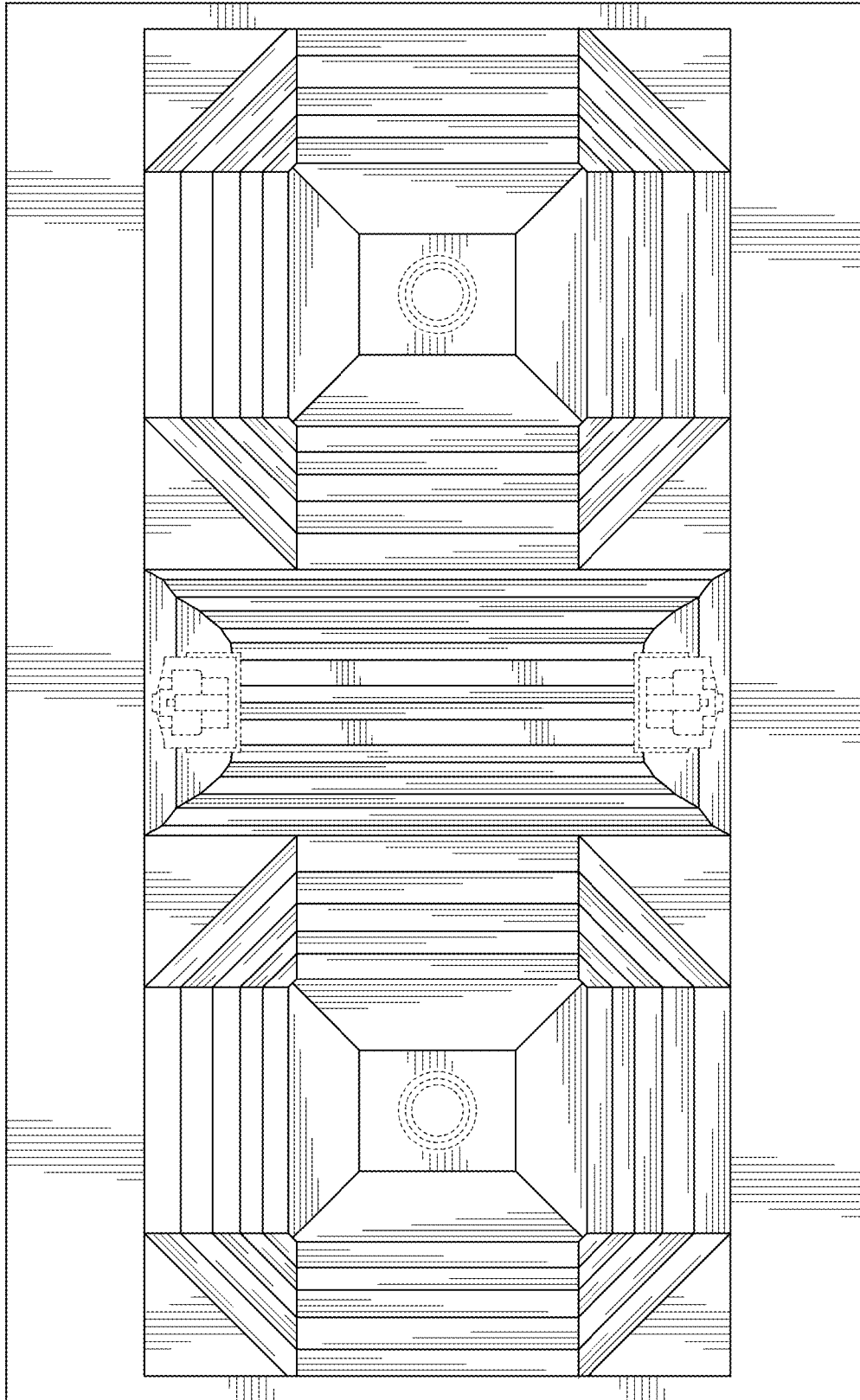

FIG. 7

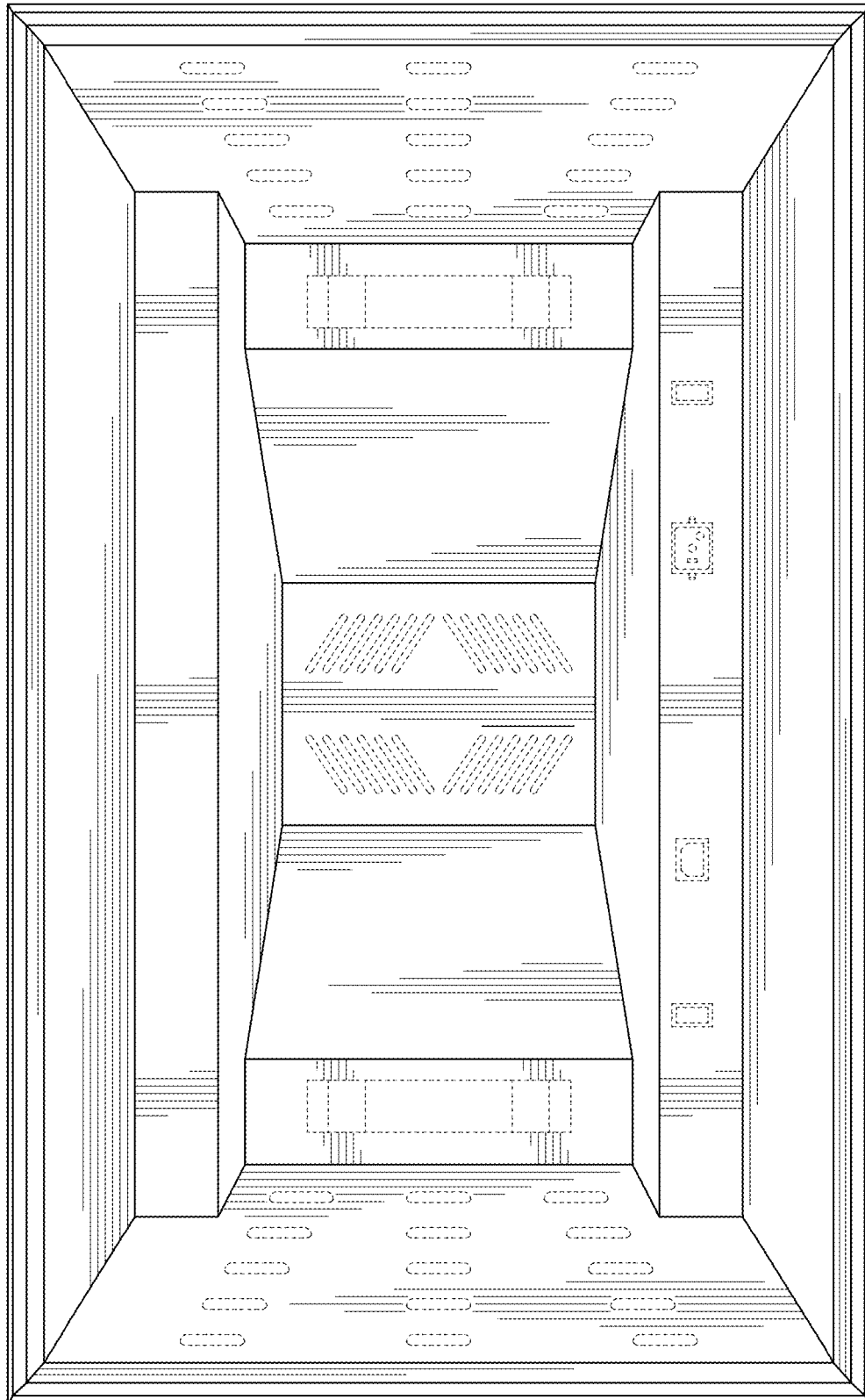

FIG. 8

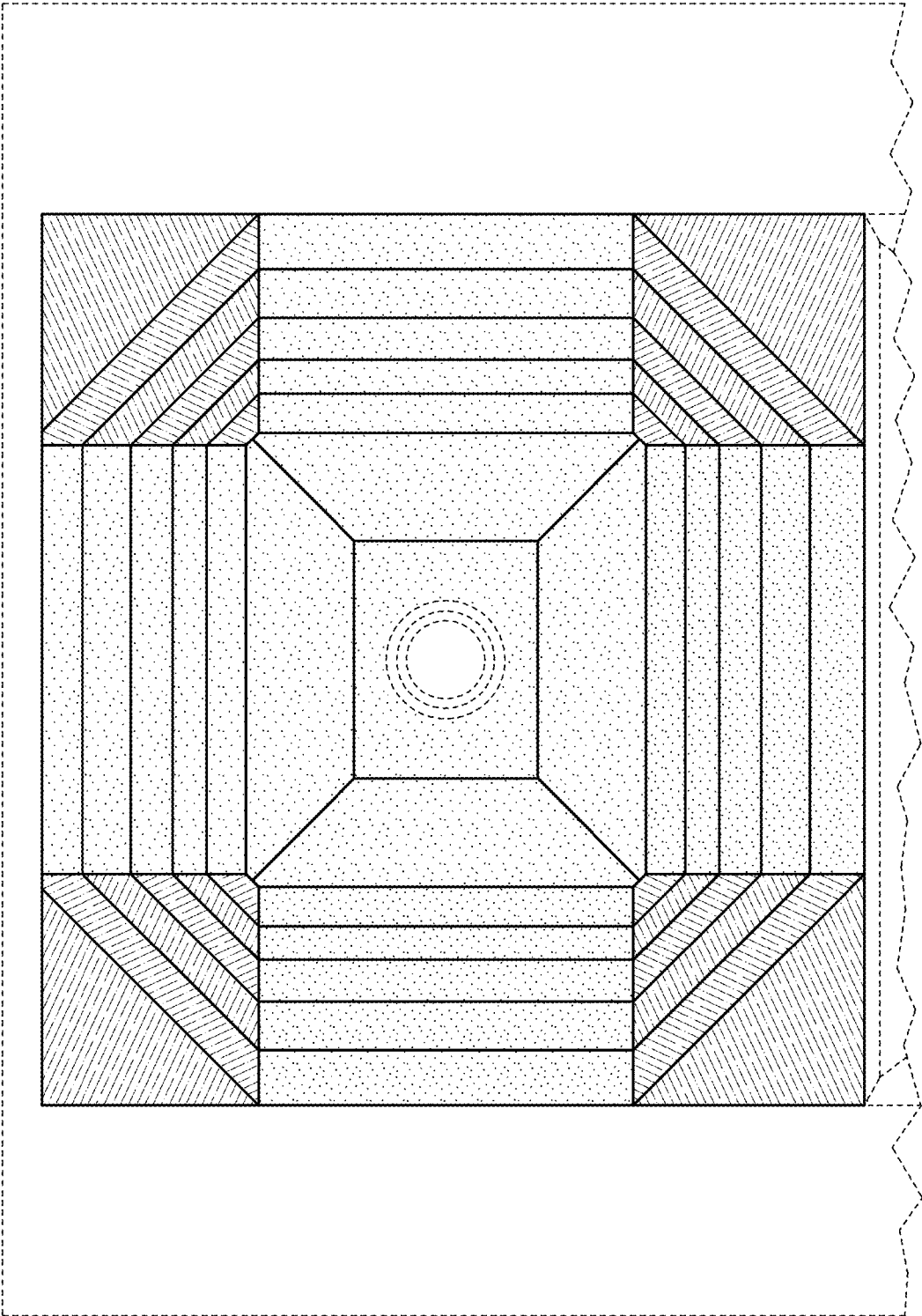

FIG. 9

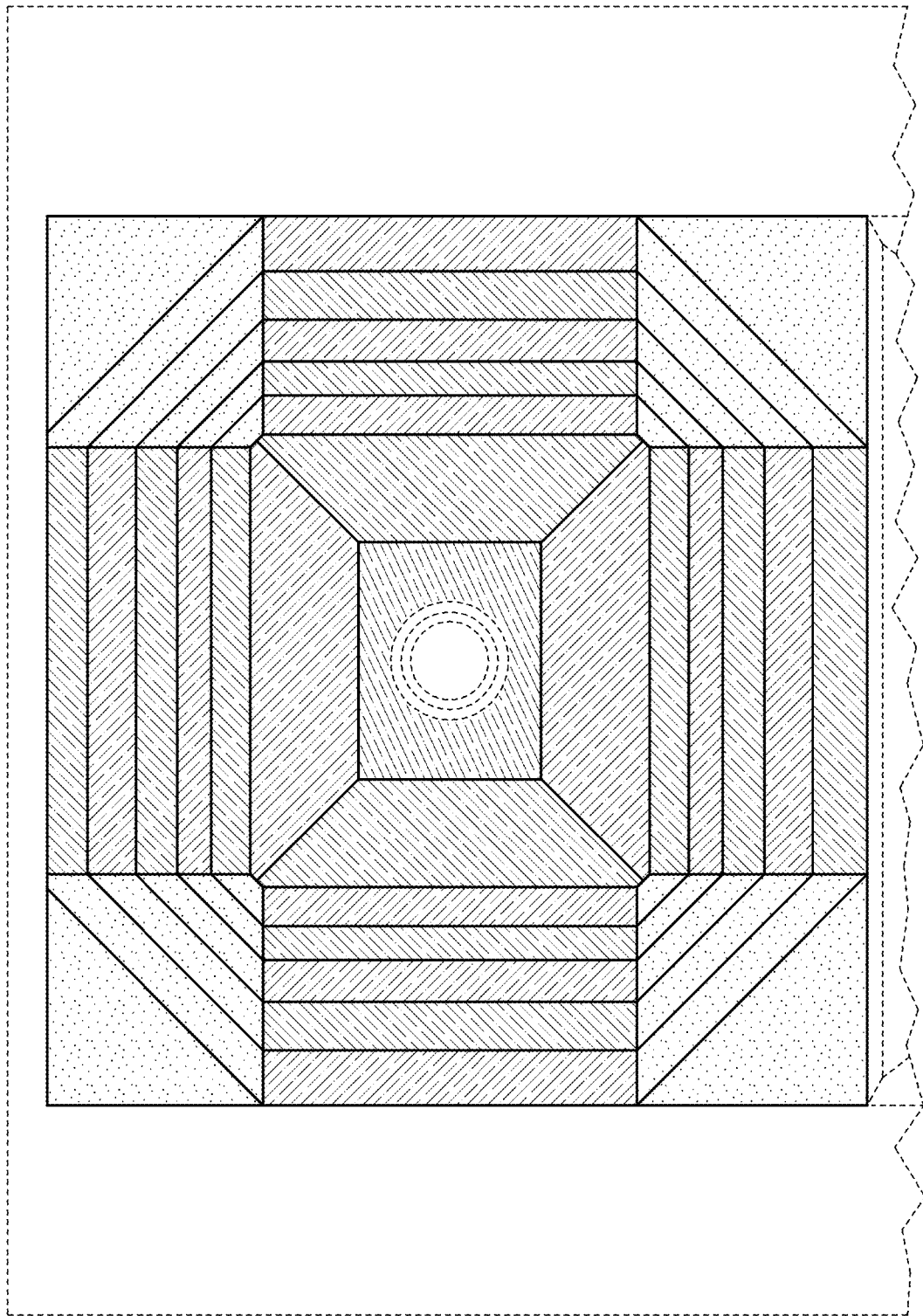

FIG. 10

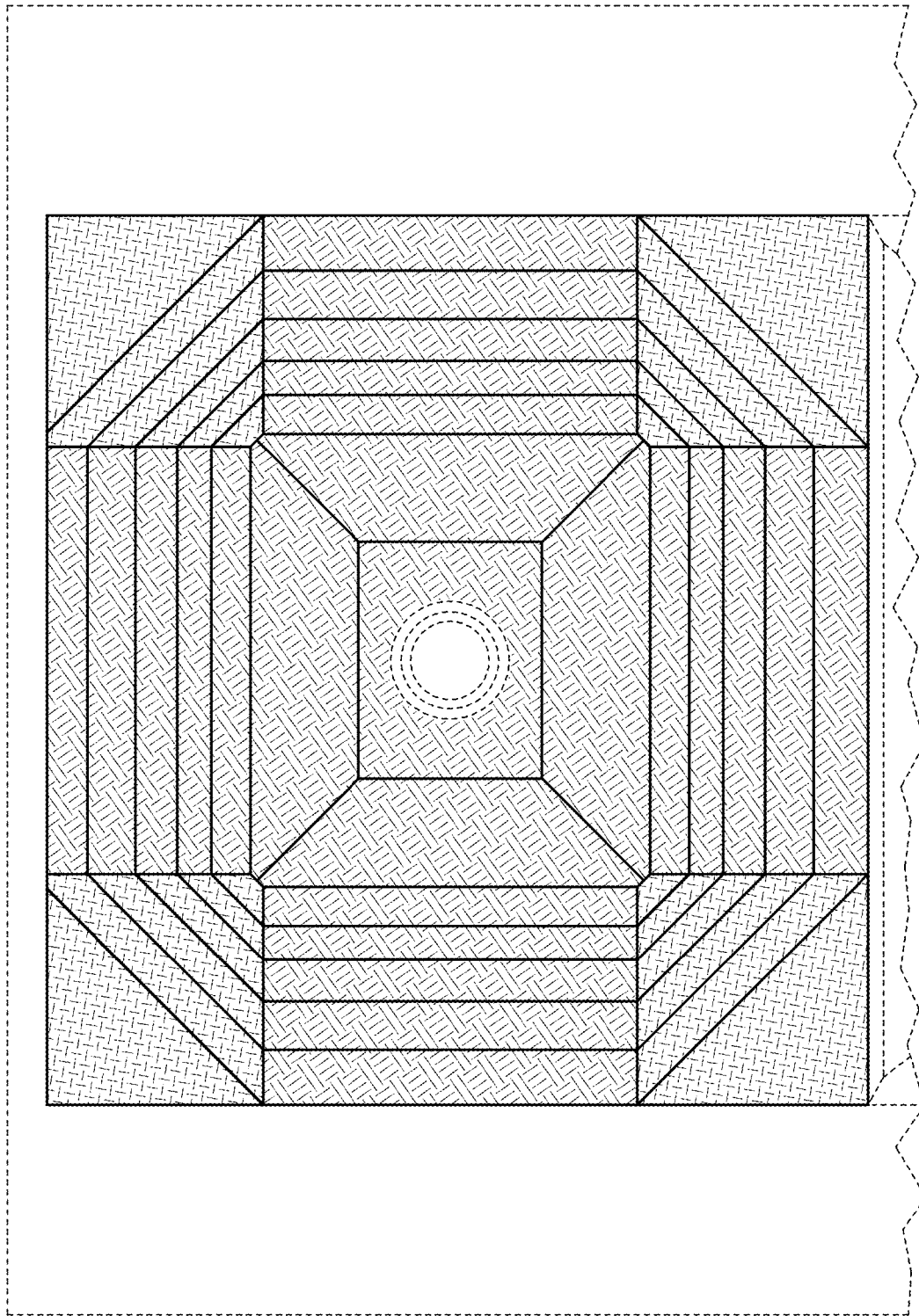

FIG. 11

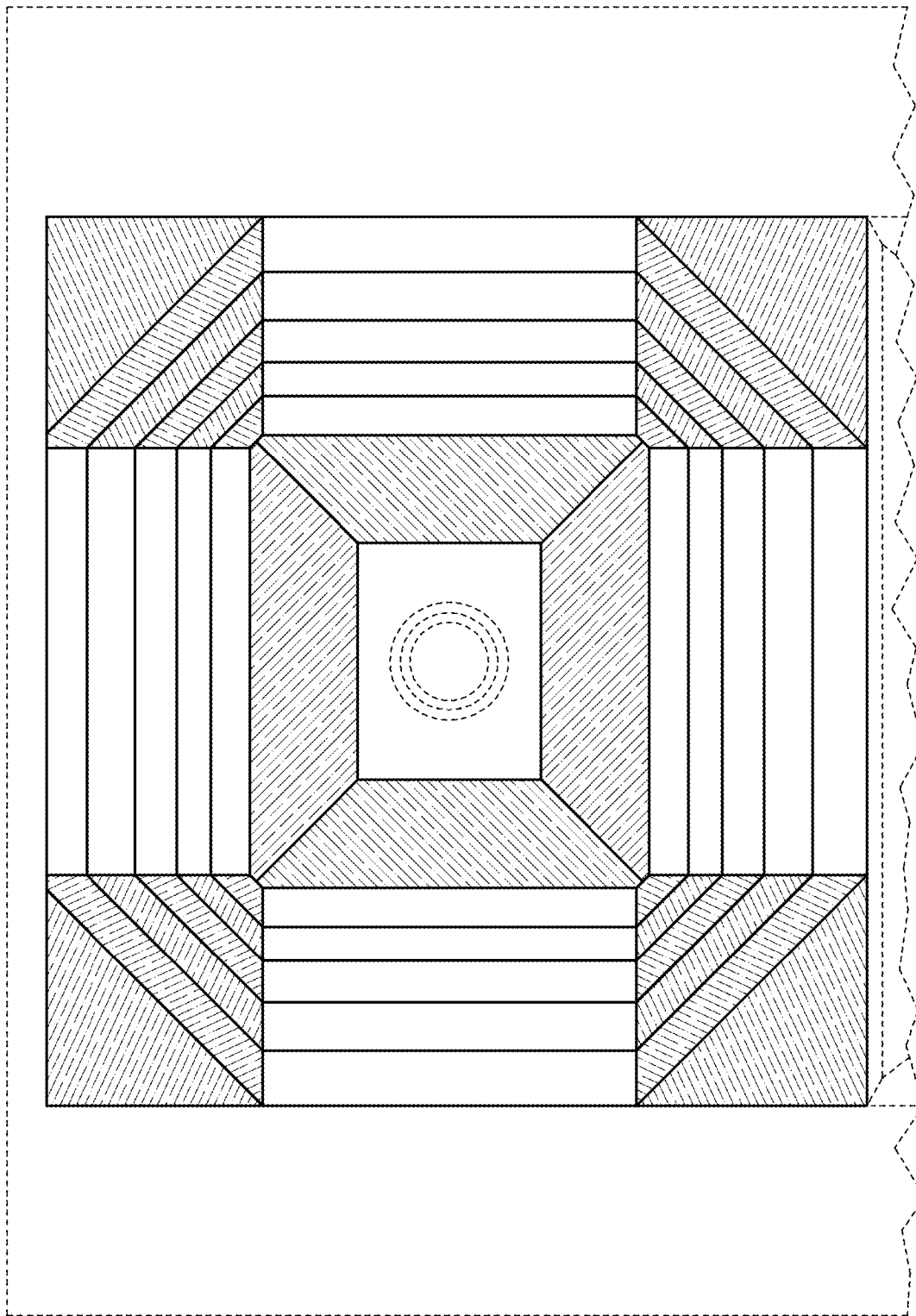

FIG. 12