



US00D744446S

(12) **United States Design Patent**
Kim

(10) **Patent No.:** **US D744,446 S**

(45) **Date of Patent:** **** Dec. 1, 2015**

(54) **TELEVISION RECEIVER**

(71) Applicant: **LG Electronics Inc.**, Seoul (KR)

(72) Inventor: **Yongsoock Kim**, Seoul (KR)

(73) Assignee: **LG Electronics Inc.**, Seoul (KR)

(**) Term: **14 Years**

(21) Appl. No.: **29/494,703**

(22) Filed: **Jun. 24, 2014**

(30) **Foreign Application Priority Data**

Jan. 9, 2014 (KR) 30-2014-0001274

(51) **LOC (10) Cl.** **14-03**

(52) **U.S. Cl.**
USPC **D14/126**

(58) **Field of Classification Search**
USPC D14/125-134, 239, 371, 136, 374-377,
D14/440, 450, 448, 336, 342, 159; 312/7.2;
348/836, 838, 180, 184, 325, 739;
248/917-924, 465; 345/104, 133, 156,
345/168, 87, 173; D21/329, 515, 577, 622,
D21/333, 433, 448, 452, 450, 331, 505;
D10/15, 26; 446/484, 175, 356;
D6/477, 479, 300
CPC ... G06F 1/1601; G06F 1/1643; H05K 5/0004;
H05K 5/0017; H05K 5/02; H05K 5/0217
See application file for complete search history.

(56) **References Cited**

U.S. PATENT DOCUMENTS

D671,084 S * 11/2012 Kim et al. D14/126
D689,033 S * 9/2013 Hwangbo et al. D14/126

D711,845 S * 8/2014 Skiadiotis et al. D14/126
D719,117 S * 12/2014 Huh et al. D14/126
D728,497 S * 5/2015 Jung D14/126

* cited by examiner

Primary Examiner — Raphael Barkai

(74) *Attorney, Agent, or Firm* — Morgan, Lewis & Bockius LLP

(57) **CLAIM**

The ornamental design for a television receiver, as shown and described.

DESCRIPTION

FIG. 1 is a perspective view of a television receiver showing my new design in which one of fourth of the display part is protruding;

FIG. 2 is a front view thereof;

FIG. 3 is a rear view thereof;

FIG. 4 is a left side view thereof;

FIG. 5 is a right side view thereof;

FIG. 6 is a top plan view thereof;

FIG. 7 is a bottom plan view thereof;

FIG. 8 is a rear perspective view thereof;

FIG. 9 is a perspective view thereof showing the state in which the display part is protruding in order to be 21:9 ratio;

FIG. 10 is a front view of FIG. 9;

FIG. 11 is a left side view of FIG. 9;

FIG. 12 is a perspective view thereof showing the state in which the display part is protruding in order to be 16:9 ratio;

FIG. 13 is a front view of FIG. 12; and,

FIG. 14 is a left side view of FIG. 12.

The broken lines show unclaimed subject matter only and form no part of the claimed design.

1 Claim, 13 Drawing Sheets

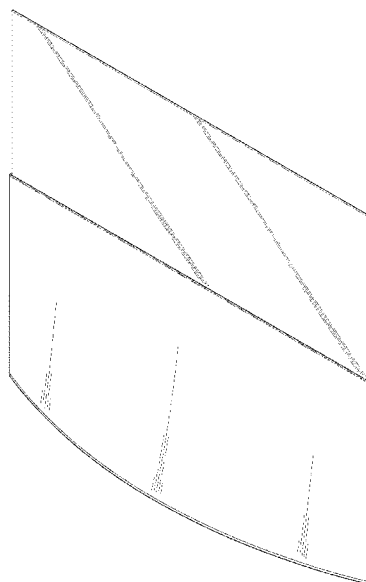
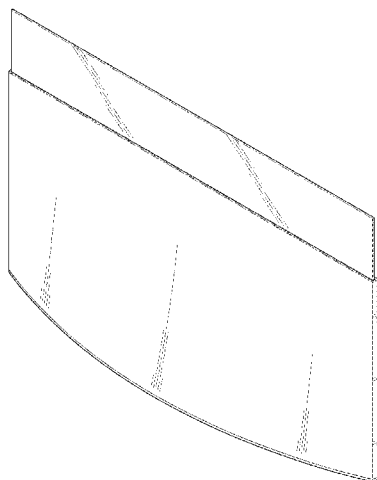

FIG. 1

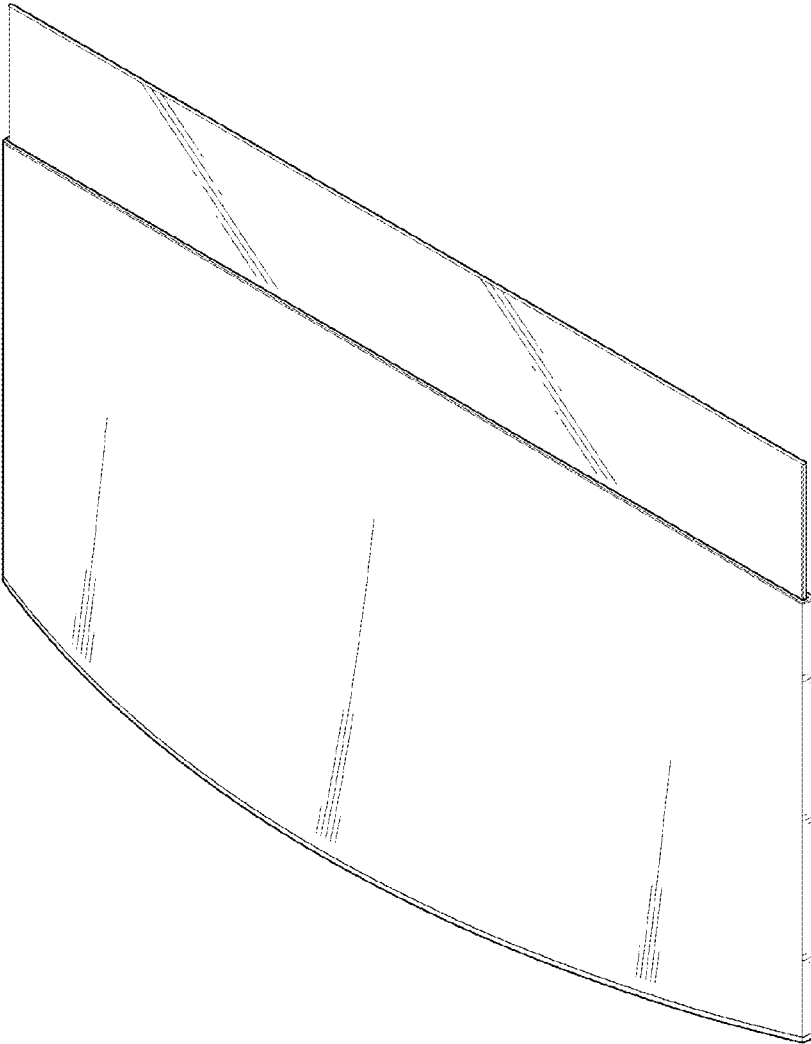

FIG. 2

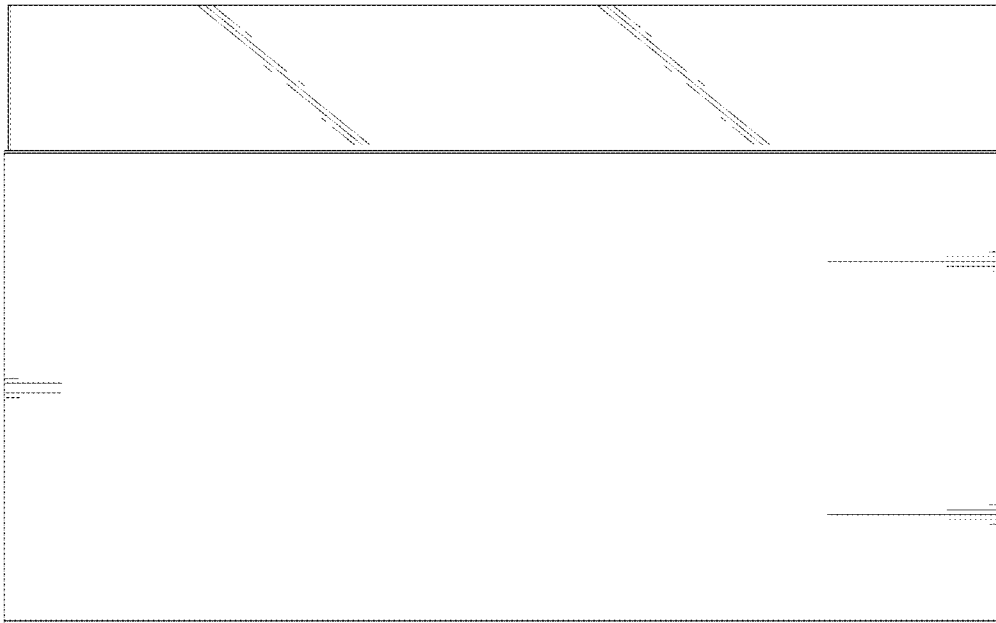

FIG. 3

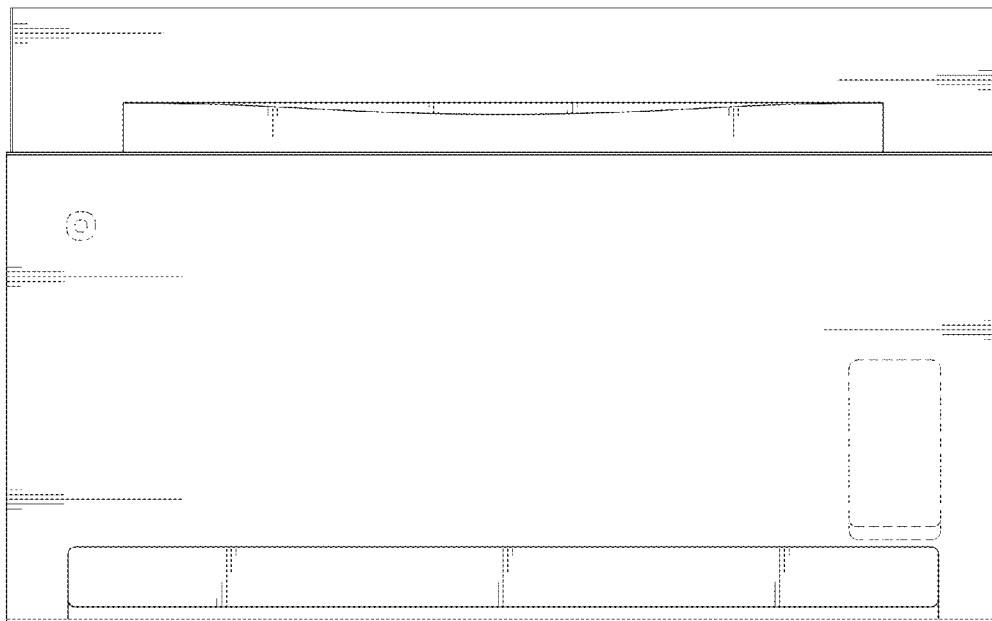

FIG. 4

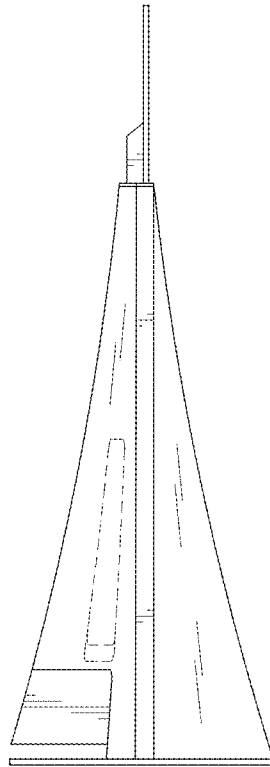

FIG. 5

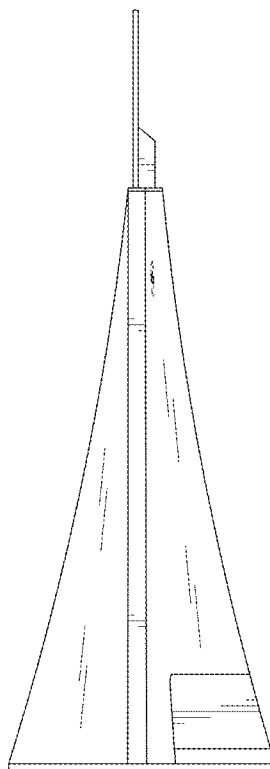

FIG. 6

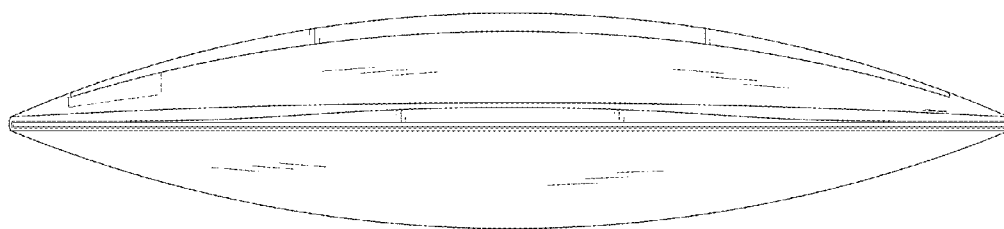

FIG. 7

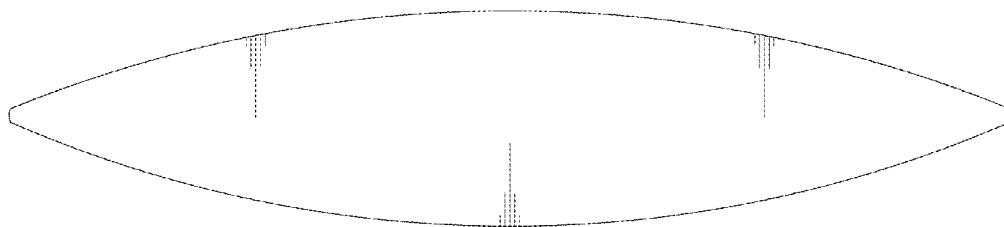

FIG. 8

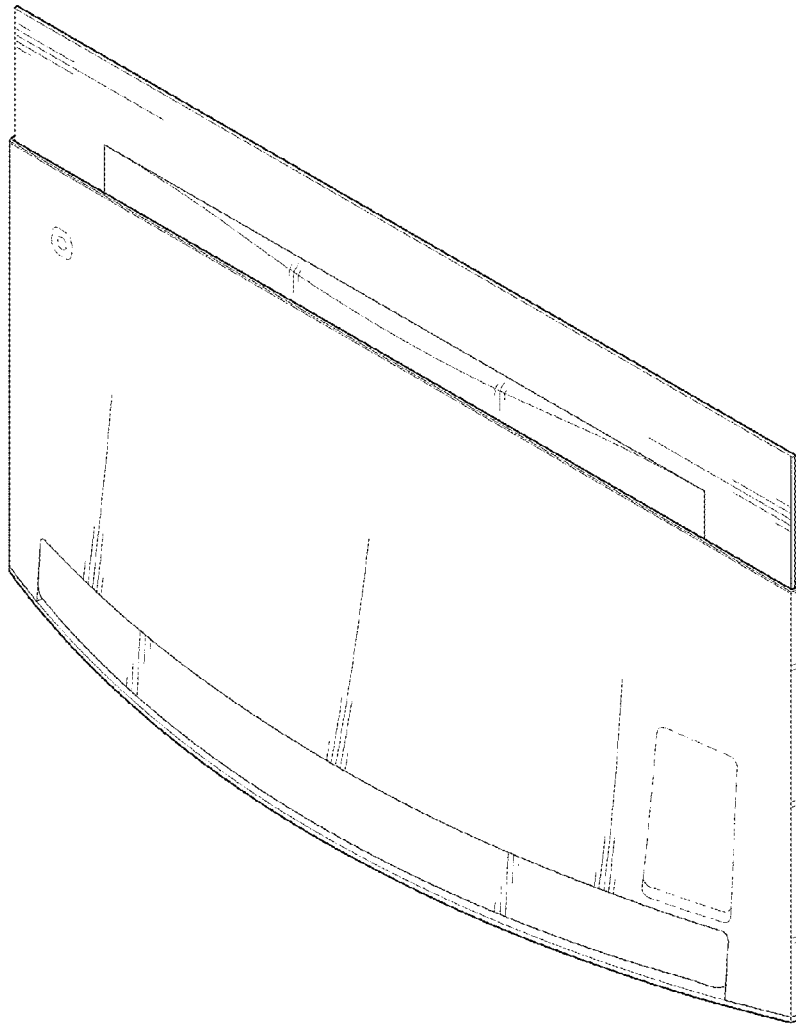

FIG. 9

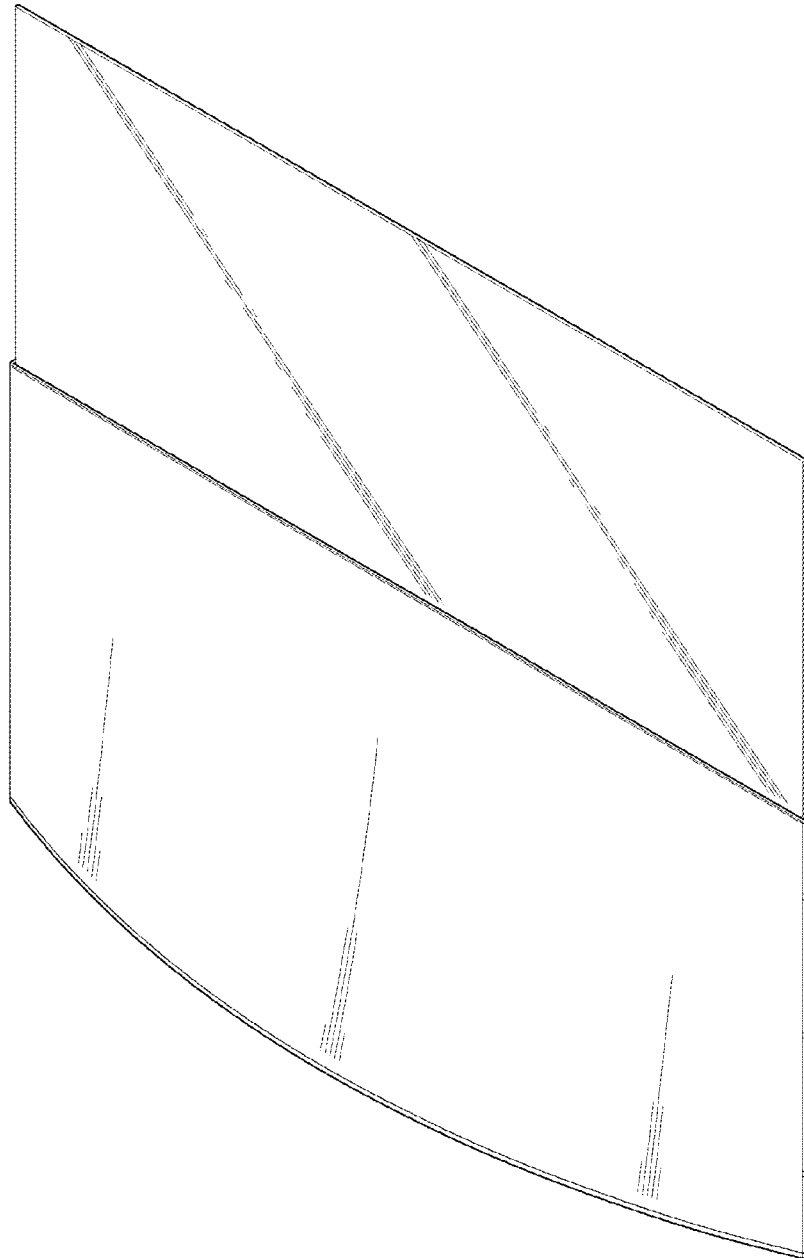

FIG. 10

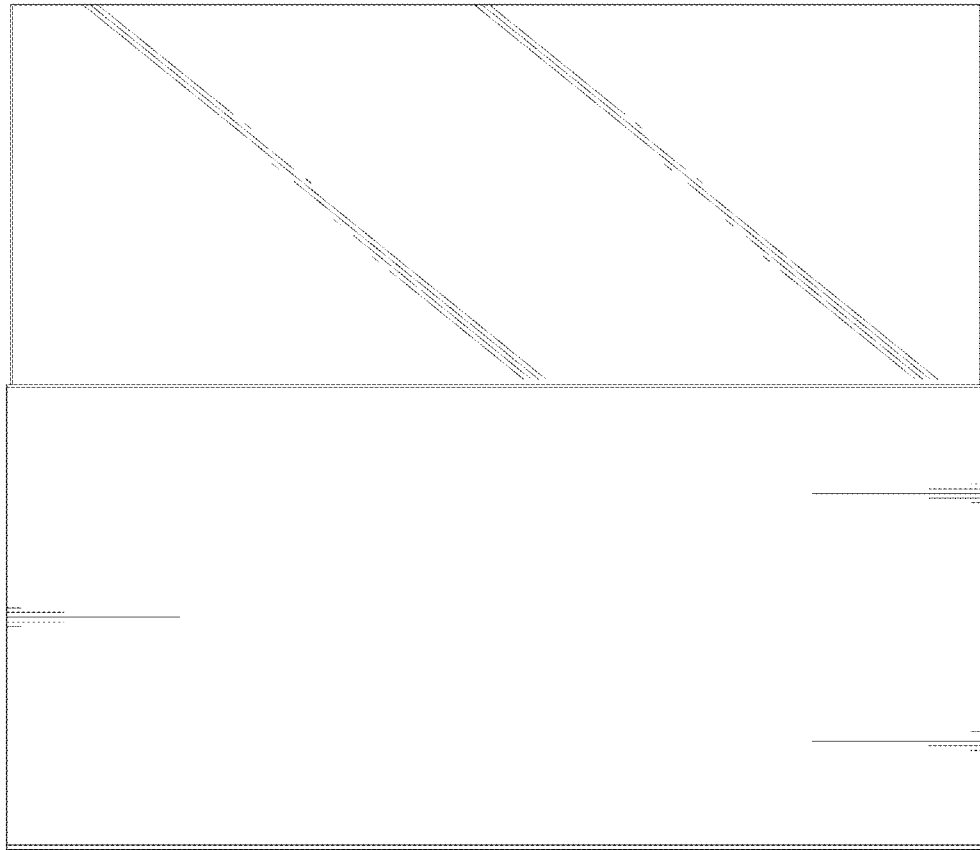

FIG. 11

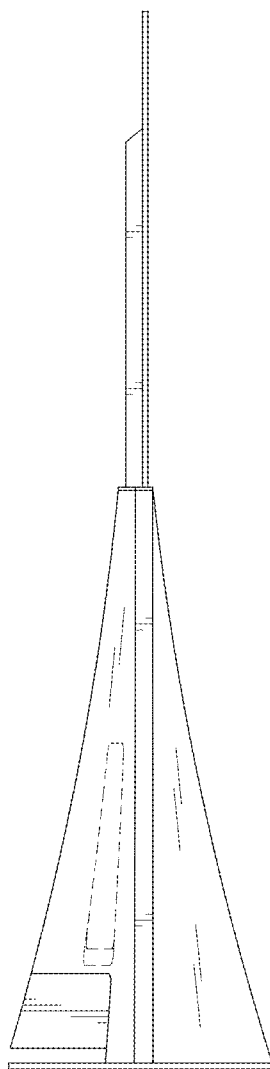

FIG. 12

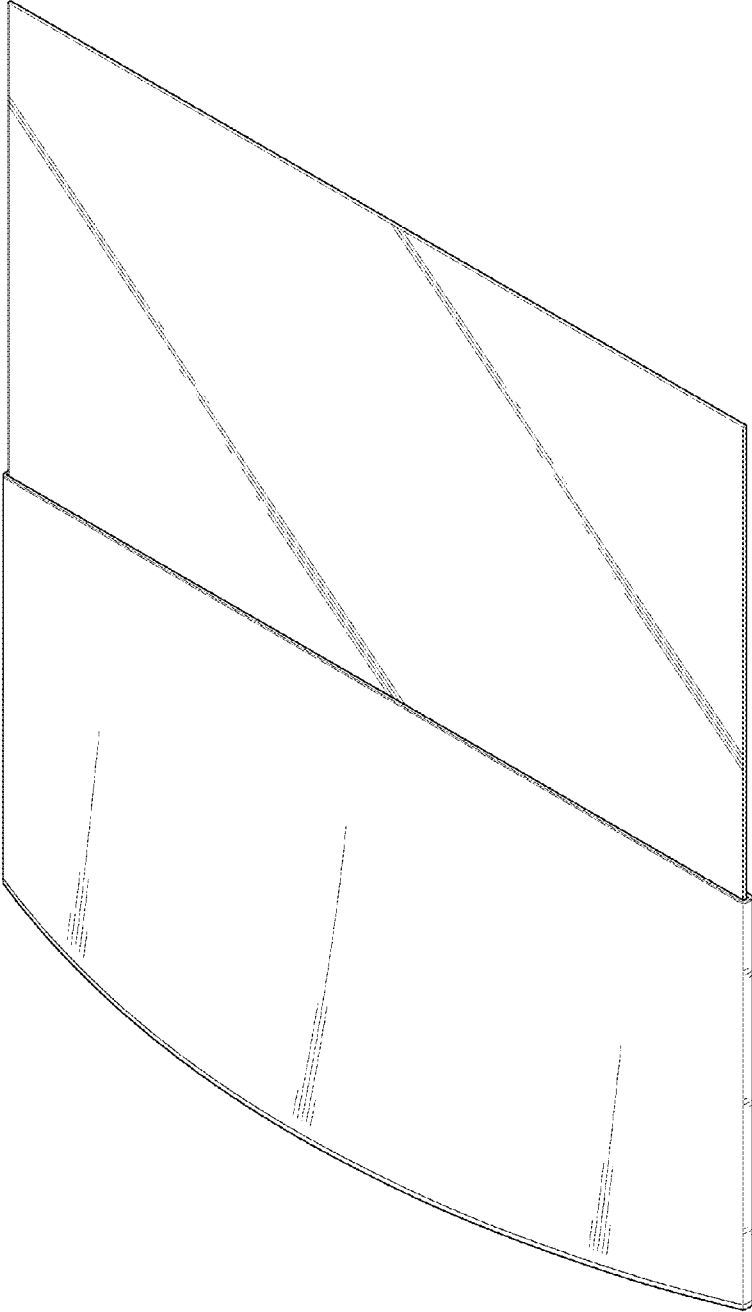

FIG. 13

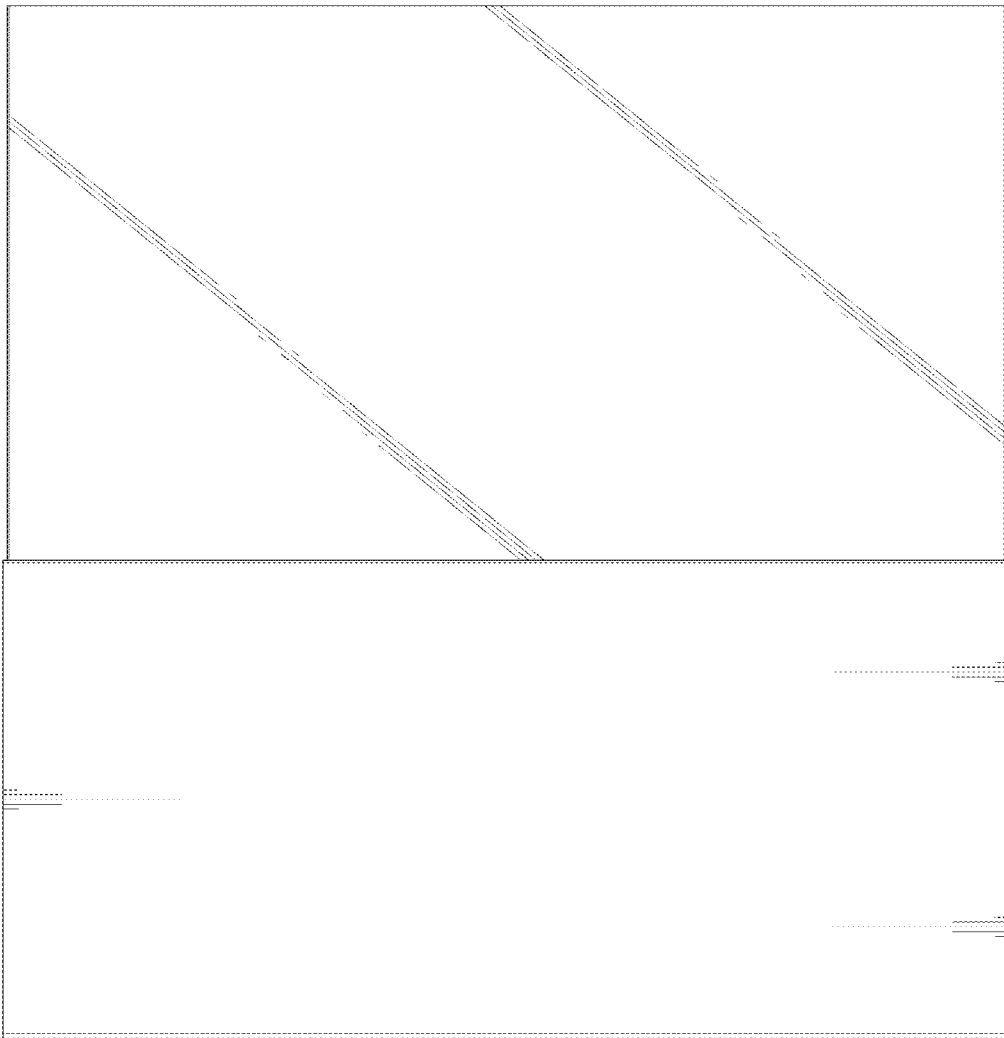

FIG. 14

