



(12) **United States Design Patent** (10) **Patent No.:** **US D892,129 S**  
**Bankov et al.** (45) **Date of Patent:** **\*\* Aug. 4, 2020**

(54) **MIMO OTA HOLDER**

(71) Applicant: **PCTEST Engineering Laboratory, Inc.**, Columbia, MD (US)

(72) Inventors: **Nikita Bankov**, San Jose, CA (US);  
**Erin Bankov**, San Jose, CA (US);  
**Justin Chao**, Ellicott City, MD (US);  
**Randy Joven Ortanez**, Morgan Hill, CA (US)

(73) Assignee: **PCTEST Engineering Laboratory, INC.**, Laurel, MD (US)

(\*\*) Term: **15 Years**

(21) Appl. No.: **29/642,741**

(22) Filed: **Apr. 2, 2018**

(51) **LOC (12) Cl.** ..... **14-02**

(52) **U.S. Cl.**  
USPC ..... **D14/447**; D14/253; D6/677.4

(58) **Field of Classification Search**  
USPC .... D14/434, 454-455, 457, 447, 238-238.1, D14/251-253; D13/107-108, D13/139.4-139.6, 162-164; D8/381, D8/354-355; D6/553, 567, 572, D6/672-673, 675, 675.3, 675.4, 677, D6/677.3-677.4, 678, 678.2, 680.2, 681, D6/681.2, 682-682.1, 682.3; D3/218; D12/415, 417, 420, 422, 223; D10/80  
CPC .... F16M 11/04; F16M 11/18; F16M 2200/00; F16M 13/00; F16M 13/02; F16M 13/022; A47F 5/00; A47F 5/16; A47F 7/00; A47F 7/02; A47F 7/022; A47F 7/0042; B60R 2011/0049; B60R 2011/0094; B60R 2011/008; B60R 2011/0241; G01R 1/0408; G01R 1/04; G01R 1/00

See application file for complete search history.

(56) **References Cited**

U.S. PATENT DOCUMENTS

D238,945 S *	2/1976	Macowski .....	D19/75
D279,851 S *	7/1985	Willis .....	D6/682.3
5,062,526 A *	11/1991	Rudnick .....	A47F 7/02
			206/486
D414,773 S *	10/1999	Heiligenstein .....	D14/238
D418,166 S *	12/1999	Dill .....	D19/88
D459,299 S *	6/2002	Hughes .....	D13/108
D460,971 S *	7/2002	Sica .....	D14/434
D516,025 S *	2/2006	Quinn .....	D13/108
D542,279 S *	5/2007	Chan .....	D14/216
D547,319 S *	7/2007	Chang .....	D13/108

(Continued)

OTHER PUBLICATIONS

Kumar, Akshay, ASUS introduces wired and wireless charging docks for Nexus 7 2013, posted at 91mobiles, posting date Feb. 27, 2014. Site visited May 14, 2019. URL: <<https://www.91mobiles.com/hub/asus-docks-nexus-7-2013/>> (Year: 2014).\*

(Continued)

*Primary Examiner* — Kevin K Rudzinski  
*Assistant Examiner* — Kathleen L Jones  
(74) *Attorney, Agent, or Firm* — McLean Law LLC; Kimberly McLean, esq.

(57) **CLAIM**  
The ornamental design for a mimo ota holder, as shown and described.

**DESCRIPTION**

FIG. 1 is a top plan view of a mimo ota holder in accordance with the present invention;  
FIG. 2 is a bottom plan view thereof;  
FIG. 3 is a left side elevational view thereof;  
FIG. 4 is a right side elevational view thereof;  
FIG. 5 is a back view thereof;  
FIG. 6 is front elevational view thereof; and,  
FIG. 7 is a perspective view thereof.

**1 Claim, 7 Drawing Sheets**

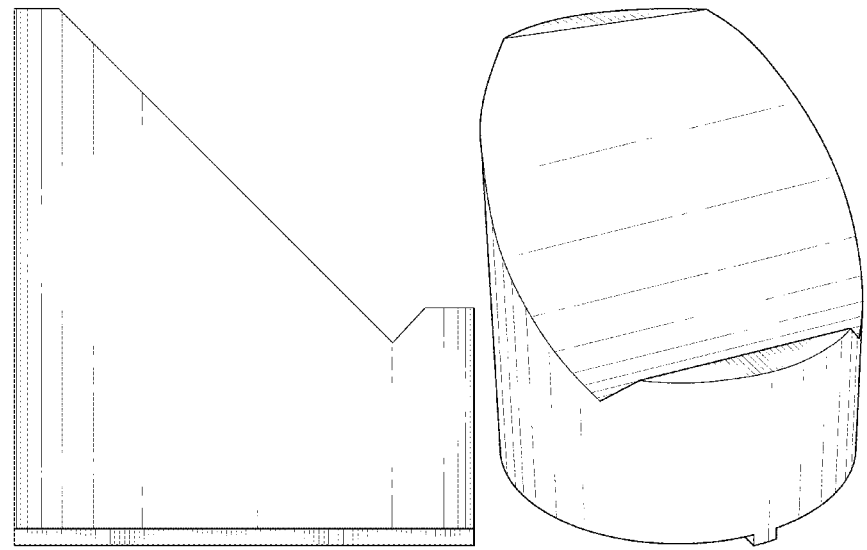

(56)

## References Cited

## U.S. PATENT DOCUMENTS

D572,189	S *	7/2008	Sarnowsky	.....	D13/108
D600,680	S *	9/2009	Mead	.....	D13/108
D628,203	S *	11/2010	Noble	.....	D14/447
7,969,732	B1 *	6/2011	Noble	.....	F16M 13/00 361/679.56
D654,921	S *	2/2012	Malsan	.....	D14/447
D655,293	S *	3/2012	Gioscia	.....	D14/434
D659,696	S *	5/2012	Lanza	.....	D14/447
D667,403	S *	9/2012	Maus	.....	D13/107
D671,546	S *	11/2012	Eberstein	.....	D14/447
D687,437	S *	8/2013	Hagenauer	.....	D14/434
D691,965	S *	10/2013	Bedolla	.....	D13/162
D693,353	S *	11/2013	Shu	.....	D14/447
D693,814	S *	11/2013	Park	.....	D14/434
D706,784	S *	6/2014	Mills	.....	D14/447
D711,366	S *	8/2014	Lui	.....	D14/253
D723,460	S *	3/2015	Gengler	.....	D13/108
D736,210	S *	8/2015	Paradise	.....	D14/434
D746,807	S *	1/2016	McGarry	.....	D14/253
D748,616	S *	2/2016	Noble	.....	D14/253
D753,057	S *	4/2016	Kubo	.....	D13/108
9,338,903	B1 *	5/2016	Loscalzo	.....	A47B 23/042
D763,244	S *	8/2016	McGarry	.....	D14/253
D779,493	S *	2/2017	Eliyahu	.....	D14/217
D844,698	S *	4/2019	Isaacs	.....	D18/12
D858,508	S *	9/2019	Lian	.....	D14/253
D859,394	S *	9/2019	Skogrand-Khatib	.....	D14/253
D865,752	S *	11/2019	Richardson	.....	D14/253
D868,018	S *	11/2019	Chen	.....	D14/149
D869,472	S *	12/2019	Wong	.....	D14/447
D870,094	S *	12/2019	Ma	.....	D14/253
D872,072	S *	1/2020	Anderson	.....	D14/253
D872,095	S *	1/2020	Miniard	.....	D14/447
D872,096	S *	1/2020	Siminoff	.....	D14/447
D873,831	S *	1/2020	DePaolo	.....	D14/434
D875,736	S *	2/2020	Ramones	.....	D14/447
D878,120	S *	3/2020	Smith	.....	D6/682.1
D878,380	S *	3/2020	Siminoff	.....	D14/447
2012/0241581	A1 *	9/2012	Chung	.....	A47B 23/042 248/346.06
2013/0229569	A1 *	9/2013	Bevirt	.....	F16M 11/12 348/373
2014/0135062	A1 *	5/2014	Bevirt	.....	F16M 11/041 455/556.1
2014/0362517	A1 *	12/2014	Moock	.....	E05B 73/0082 361/679.43
2015/0300556	A1 *	10/2015	Fan	.....	A45C 1/12 248/346.03
2018/0316843	A1 *	11/2018	Guyot	.....	F16M 13/00
2019/0133344	A1 *	5/2019	Bogdan	.....	A47F 7/142

## OTHER PUBLICATIONS

Desk Charging dock Station phone Holder for Xiaomi Oneplus for Huawei mobile, posted at DHgate, posting date not available. Site visited May 14, 2019. URL: <<https://www.dhgate.com/product/desk-charging-dock-station-phone-holder-for/431957692.html>>.\*

\* cited by examiner

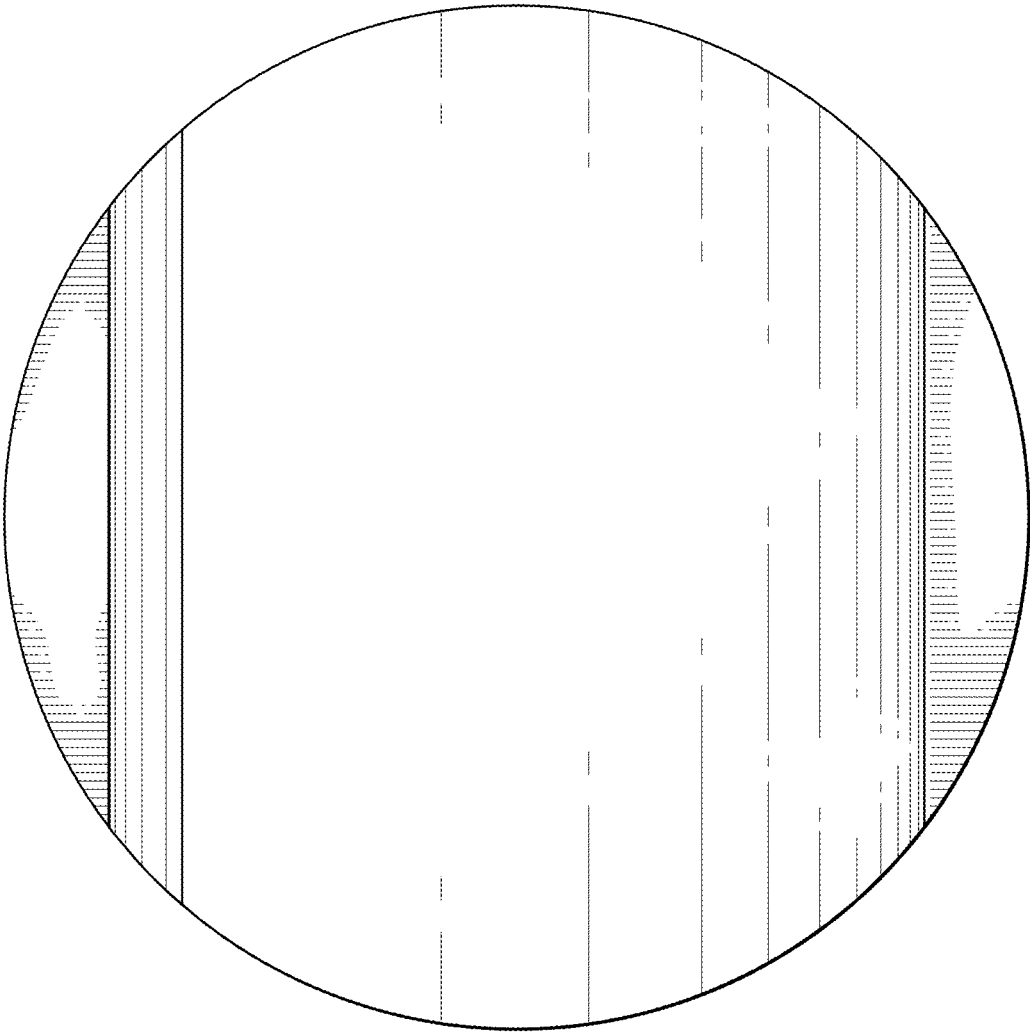

FIG. 1

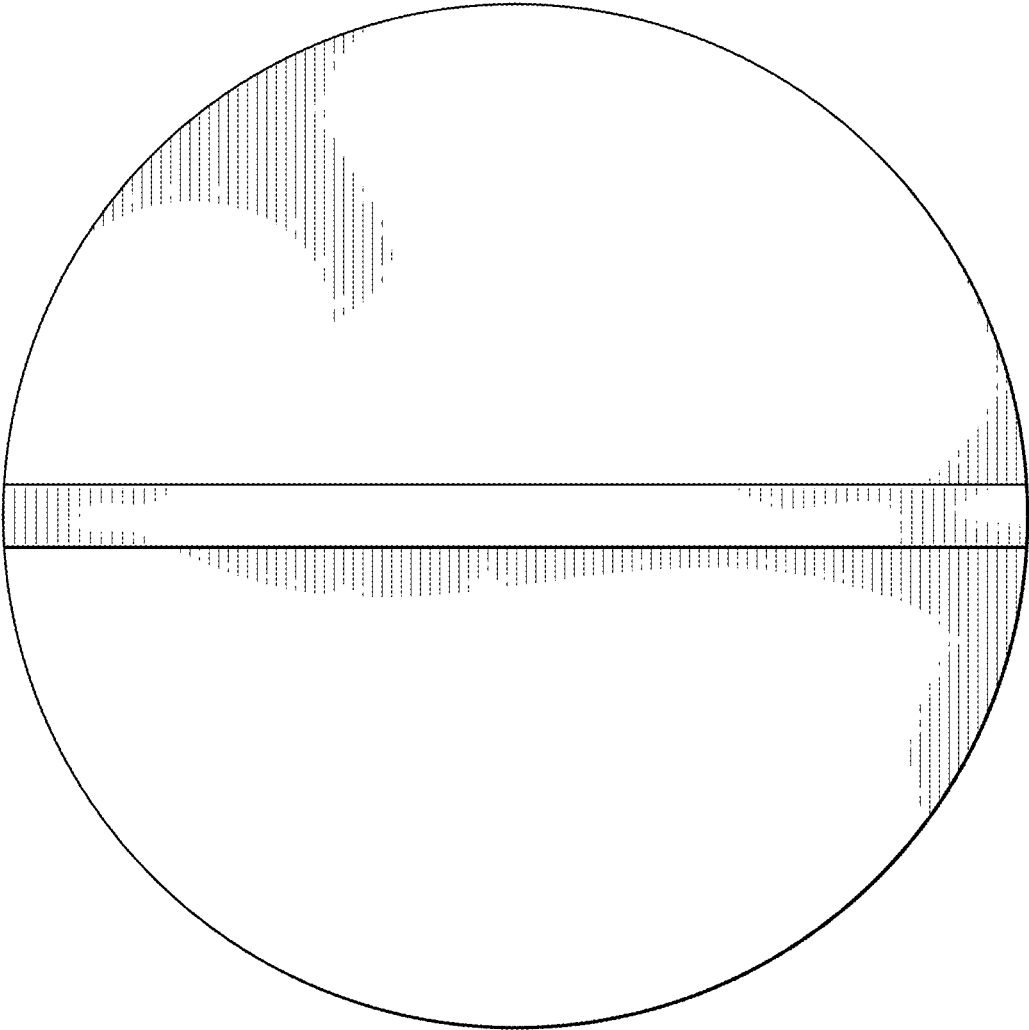

FIG. 2

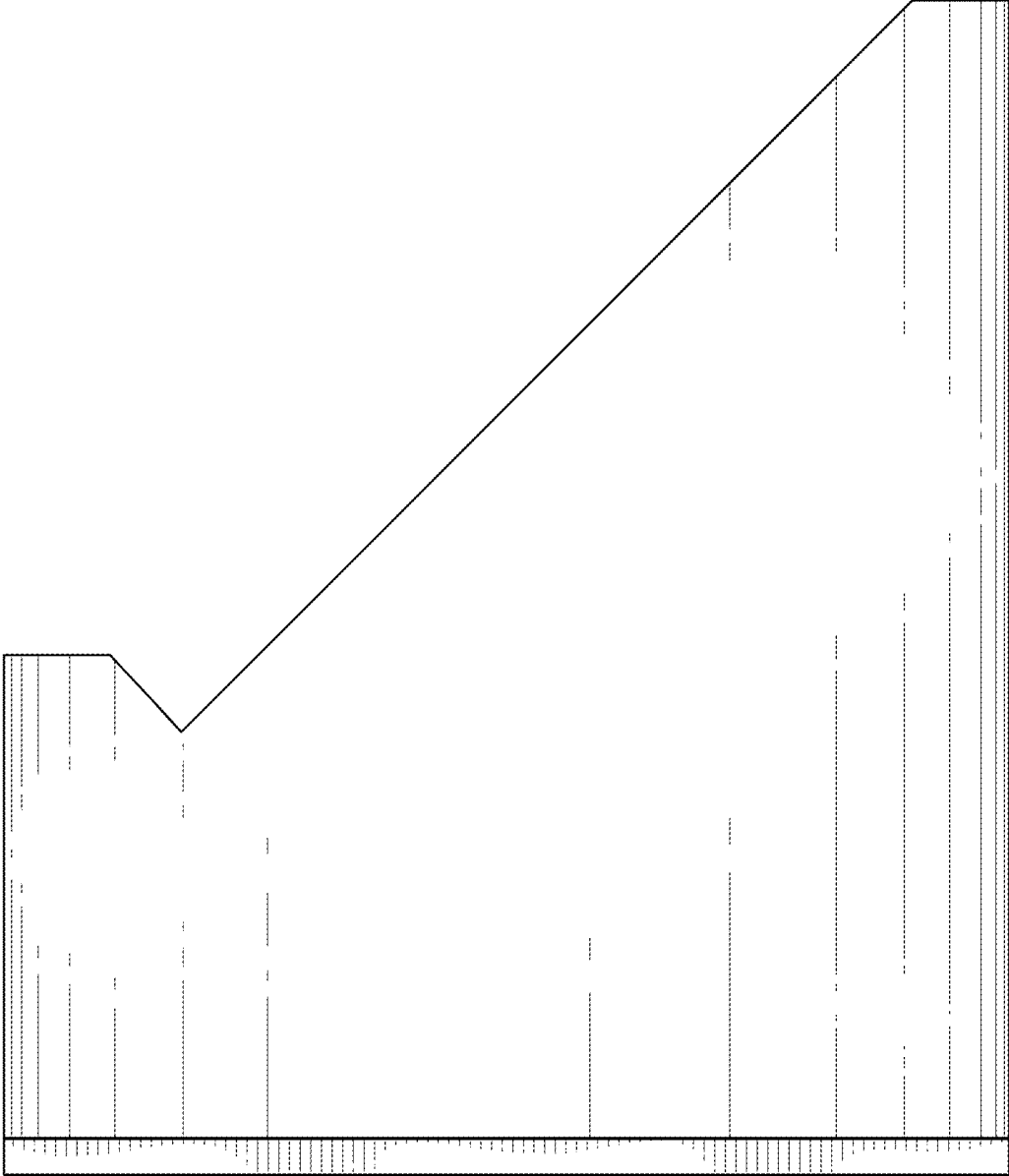

FIG. 3

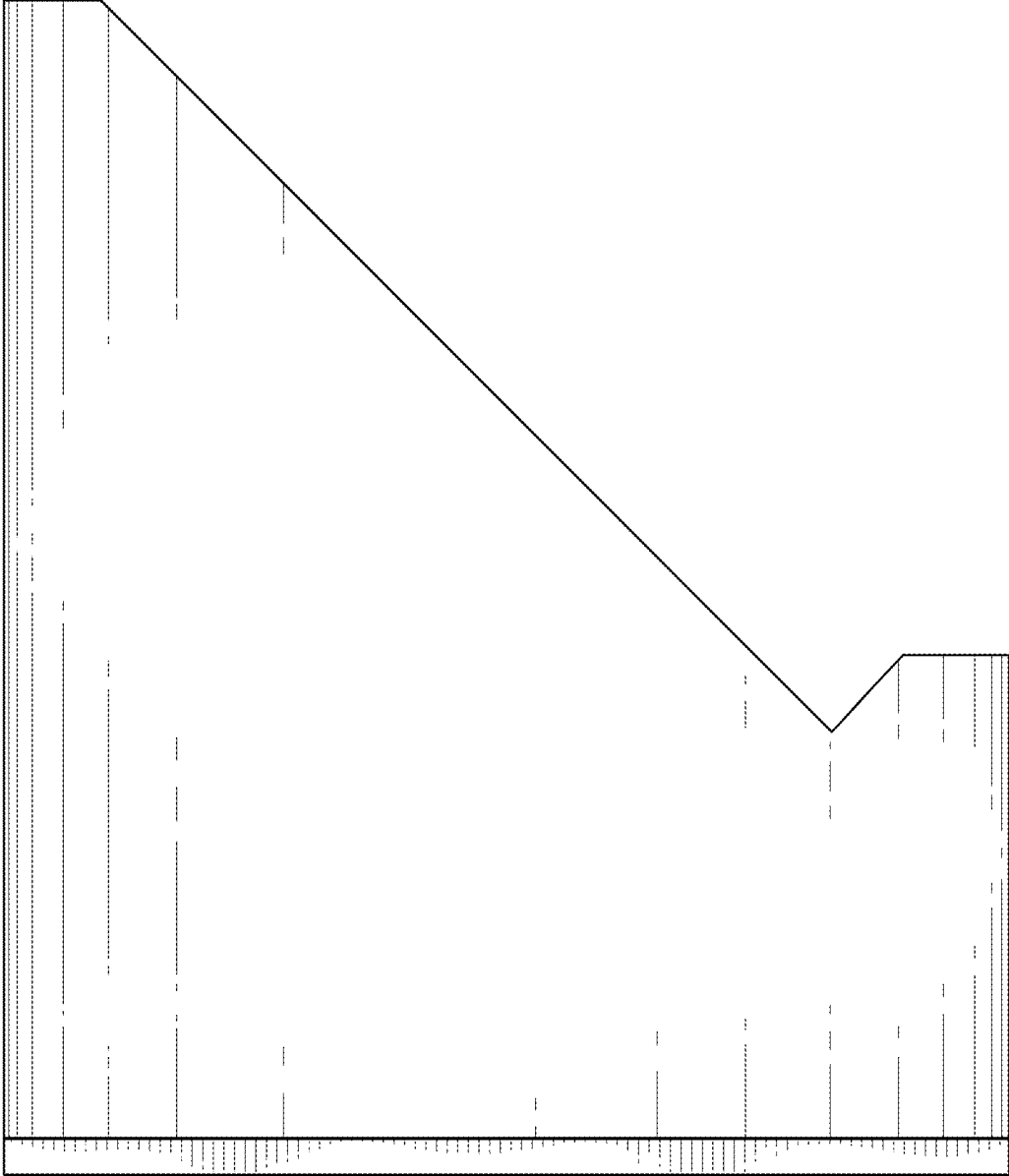

FIG. 4

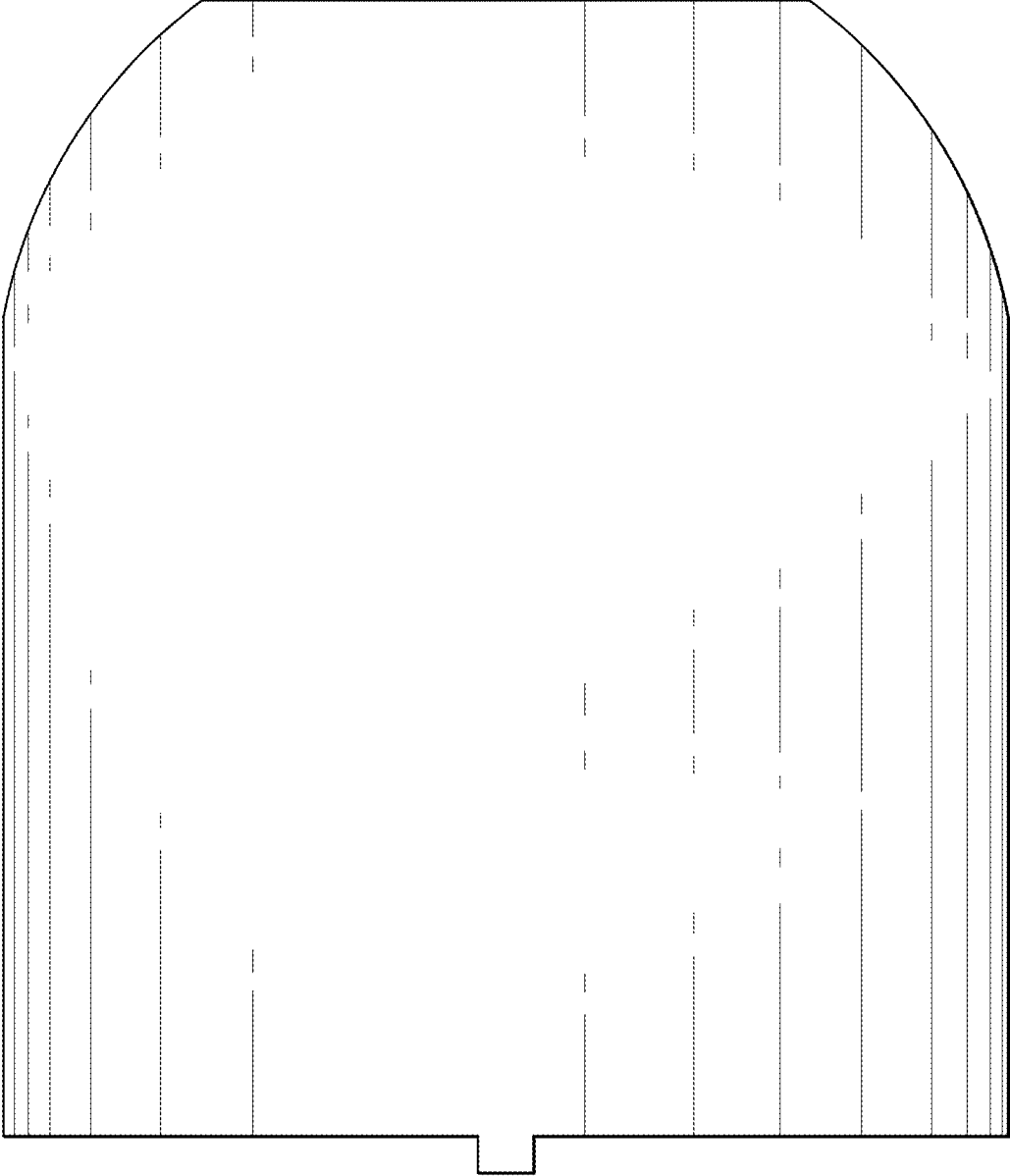

FIG. 5

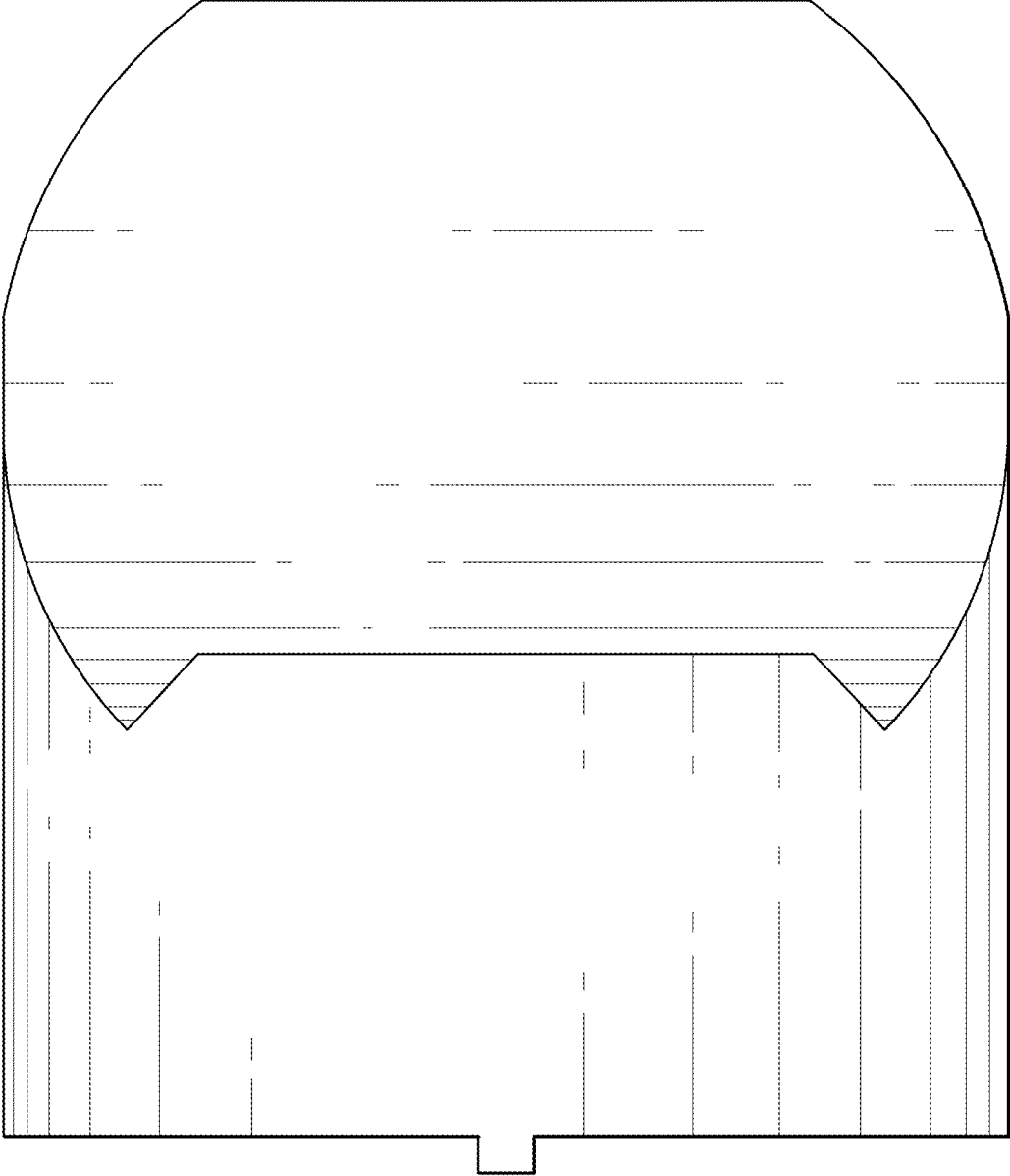

FIG. 6

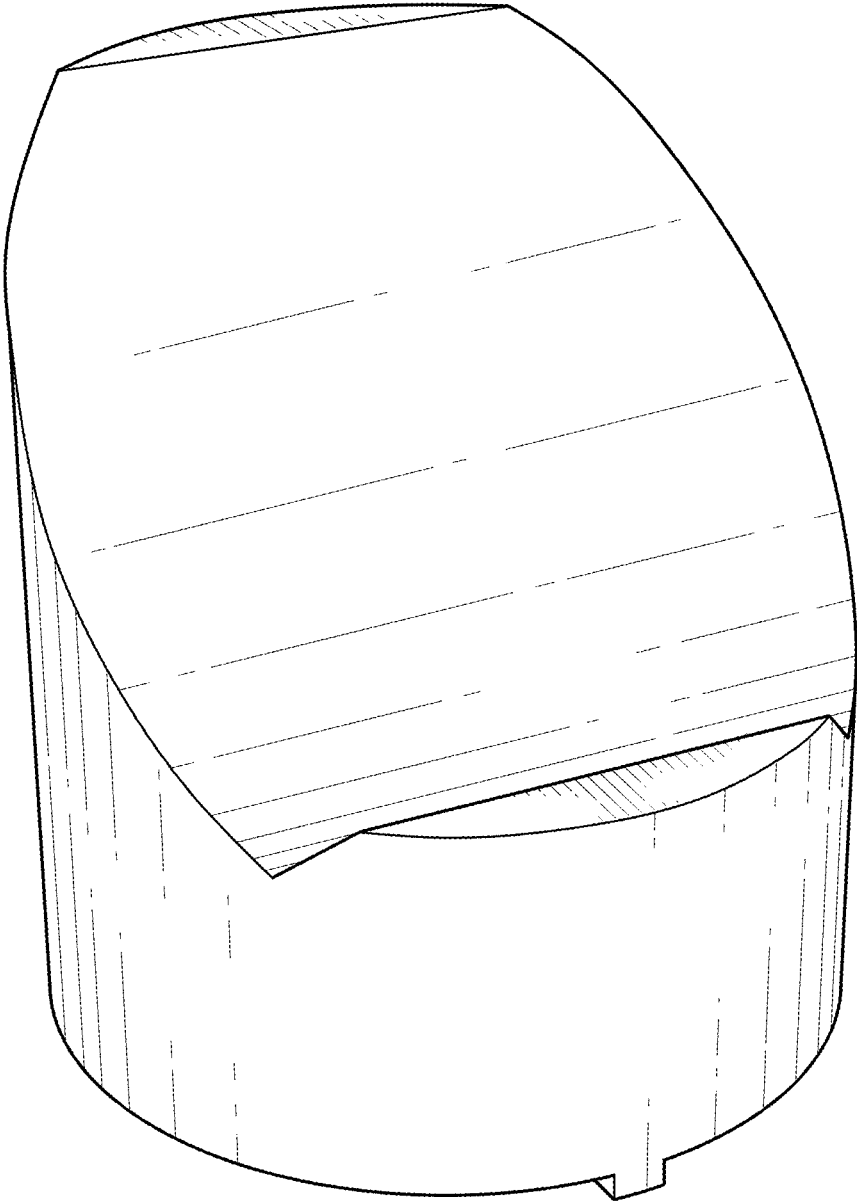

FIG. 7