



US00D782736S

(12) **United States Design Patent**
Stephens et al.

(10) **Patent No.:** **US D782,736 S**

(45) **Date of Patent:** **** Mar. 28, 2017**

(54) **ACCESSORY FOR A HAIRDRYER**

5,275,339 A * 1/1994 Andis A45D 20/122
239/443

(71) Applicant: **Dyson Technology Limited**, Wiltshire
(GB)

D349,585 S * 8/1994 Rizzuto, Jr. D28/18
D407,848 S * 4/1999 Celik D28/13
D429,374 S * 8/2000 Muller D28/18
D477,112 S * 7/2003 Yeung D28/18
D617,945 S * 6/2010 Kim D28/18
D715,486 S * 10/2014 Brady D28/18
9,408,452 B1 * 8/2016 Al-Khulaifi A45D 20/12
2011/0209721 A1* 9/2011 Yahnker A45D 20/12
132/271

(72) Inventors: **Philip Jonathan Stephens**, Swindon
(GB); **Stephen Farrar Smith**, Bristol
(GB); **Andrea Ee-Va Lim**, Bristol
(GB); **Peter David Gammack**,
Swindon (GB)

(73) Assignee: **Dyson Technology Limited**,
Malmesbury, Wiltshire (GB)

FOREIGN PATENT DOCUMENTS

(**) Term: **15 Years**

DE EP 0439781 A1 * 8/1991 A45D 20/122
DE 4100509 A1 * 7/1992 A45D 20/122
DE 9214397 U1 * 12/1992 A45D 20/122
DE 29507649 U1 * 9/1996 A45D 20/122
JP WO 2014034919 A1 * 3/2014 A45D 20/10
RU 00098857 * 7/2016
WO D054626-001 * 2/2001

(21) Appl. No.: **29/549,139**

(22) Filed: **Dec. 18, 2015**

* cited by examiner

(30) **Foreign Application Priority Data**

Jun. 18, 2015 (EM) 001436281-0003

Primary Examiner — Catherine Tuttle

(51) **LOC (10) Cl.** **28-03**

Assistant Examiner — Mary Malley

(52) **U.S. Cl.**

(74) *Attorney, Agent, or Firm* — Morrison & Foerster
LLP

USPC **D28/18**

(58) **Field of Classification Search**

(57) **CLAIM**

USPC ... D28/9, 10, 12, 13, 14, 15, 17, 18, 19, 20,
D28/25, 28; D30/158, 159; 34/98
CPC A45D 20/00; A45D 20/04; A45D 20/08;
A45D 20/10; A45D 20/12; A45D 20/122;
A45D 20/14; A45D 20/124; A45D 20/26;
A45D 20/16; A45D 2020/126; A45D
2020/128

We claim the ornamental design for an accessory for a
hairdryer, as shown and described.

See application file for complete search history.

DESCRIPTION

(56) **References Cited**

U.S. PATENT DOCUMENTS

D265,598 S * 7/1982 Radatz D28/18
D287,297 S * 12/1986 Reid D28/12

1 Claim, 6 Drawing Sheets

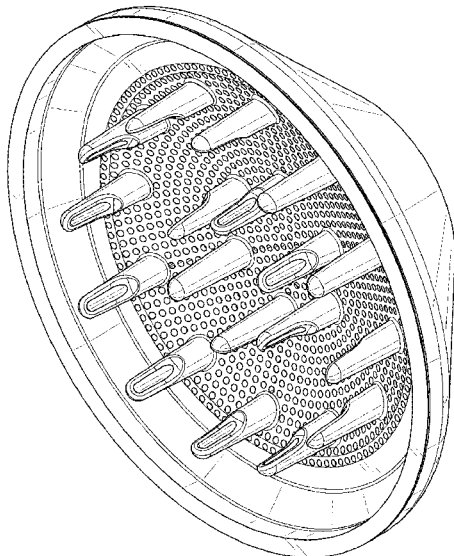

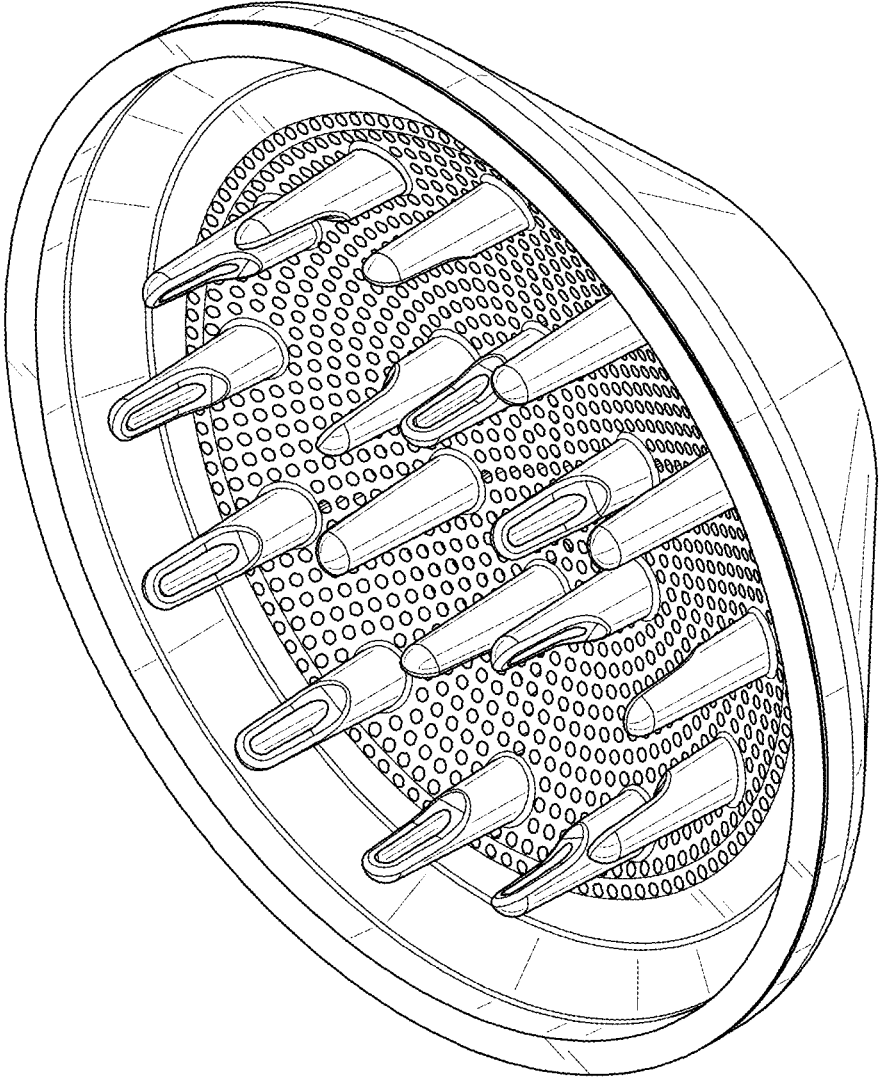

FIG. 1

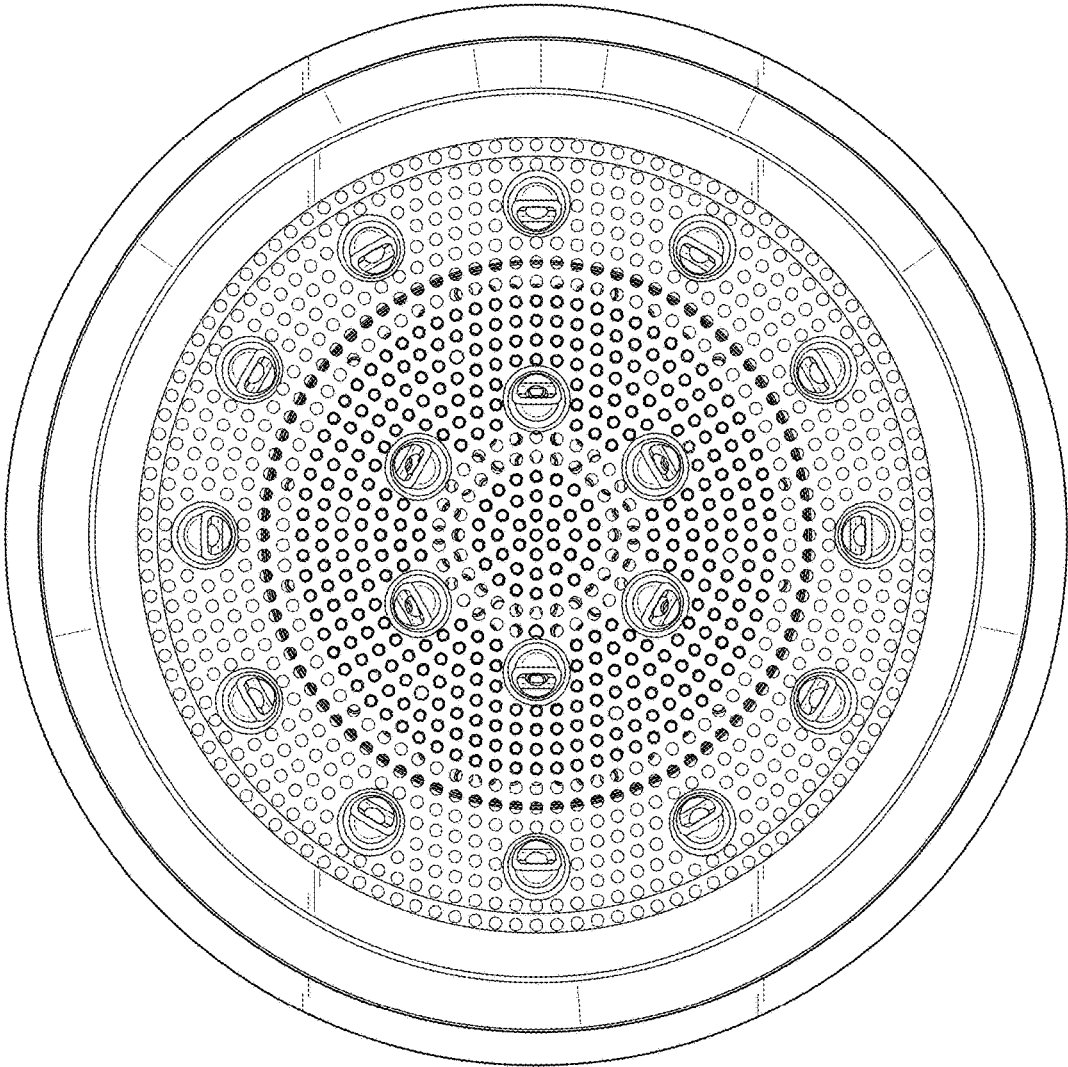

FIG. 2

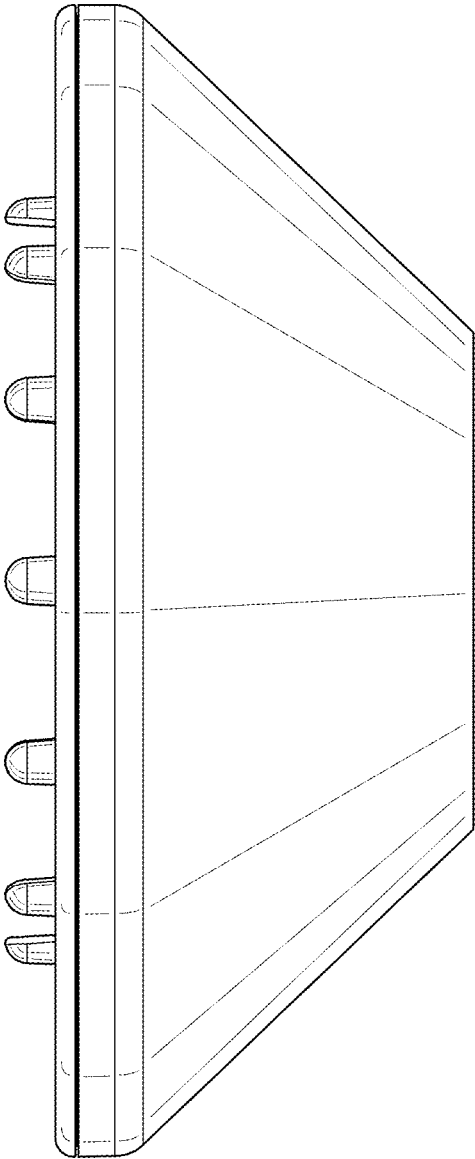

FIG. 3

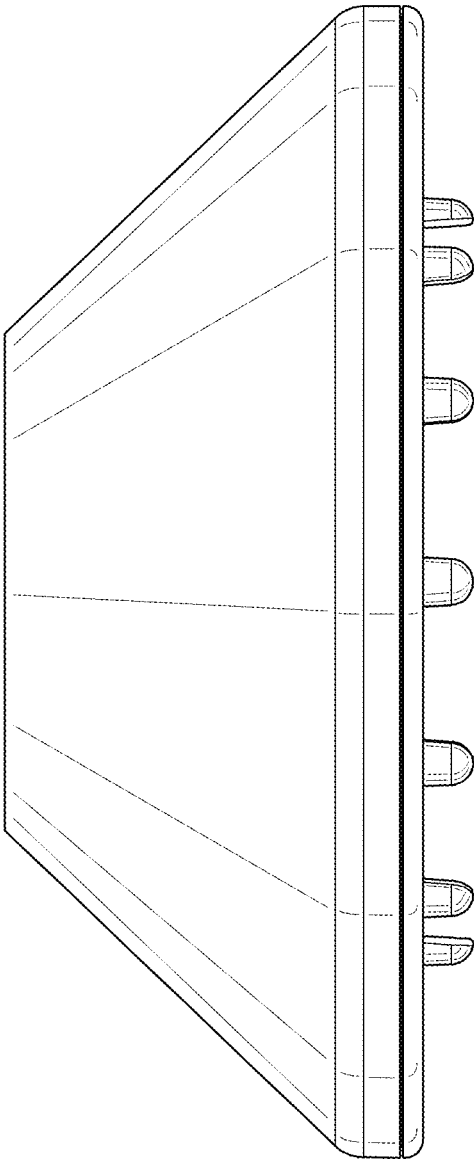

FIG. 4

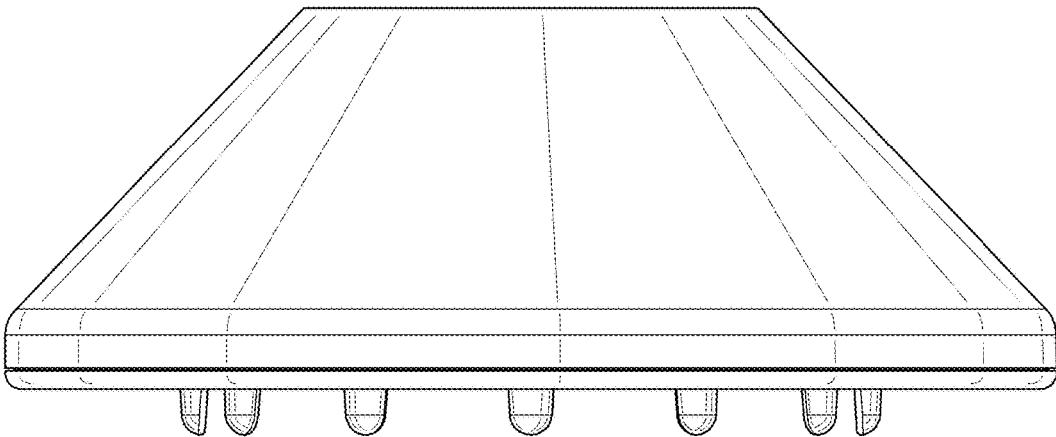

FIG. 5

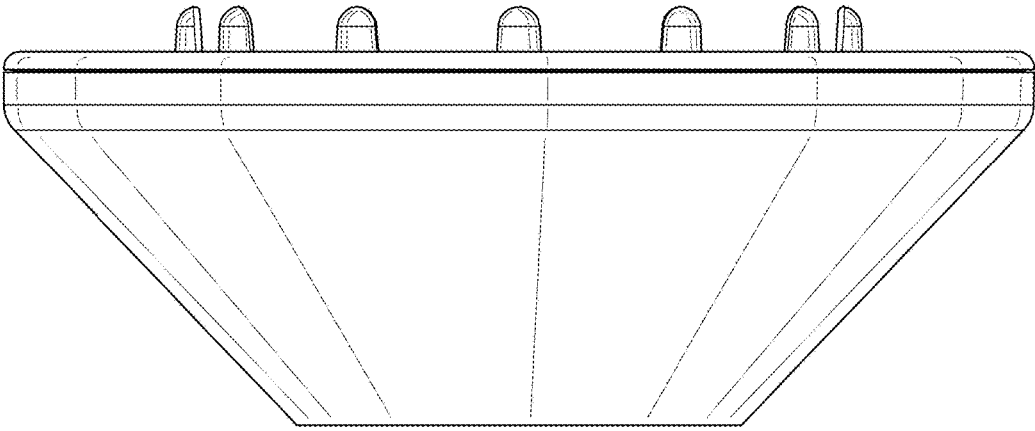

FIG. 6