



US00D445425S

(12) **United States Design Patent**  
**Koken et al.**

(10) **Patent No.:** **US D445,425 S**

(45) **Date of Patent:** **\*\* Jul. 24, 2001**

(54) **FRONT PANEL MEDIA DOOR**

D. 408,386 \* 4/1999 Yeh et al. .... D14/445

(75) Inventors: **Michael A. Koken**, Sunnyvale; **Chris L. Whittall**, Berkeley; **Erik A. Jensen**, San Francisco; **Max G. Chen**, Palo Alto, all of CA (US)

\* cited by examiner

*Primary Examiner*—Freda Nunn  
(74) *Attorney, Agent, or Firm*—Baker Botts L.L.P.

(73) Assignee: **Silicon Graphics**, Mountain View, CA (US)

(57) **CLAIM**

The ornamental design for a front panel media door, as shown and described.

(\*\*) Term: **14 Years**

**DESCRIPTION**

(21) Appl. No.: **29/125,876**

FIG. 1 is a perspective view taken from the top and right side of a front panel media door showing our new design; FIG. 2 is a front elevational view thereof; FIG. 3 is a right side elevational view thereof; FIG. 4 is a left side elevational view thereof; FIG. 5 is a top plan view thereof; and, FIG. 6 is a bottom plan view thereof.

(22) Filed: **Jun. 30, 2000**

(51) **LOC (7) Cl.** ..... **14-02**

(52) **U.S. Cl.** ..... **D14/445**

(58) **Field of Search** ..... D14/441-446,  
D14/257, 258; D13/164, 177; D10/103;  
312/223.2

FIG. 1 is shown with the front panel media door as used in the environment and the broken lines are shown for illustrative purposes only and form no part of the claimed design.

(56) **References Cited**

**U.S. PATENT DOCUMENTS**

D. 363,477 \* 10/1995 Tinsley, Jr. et al. .... D14/445

**1 Claim, 2 Drawing Sheets**

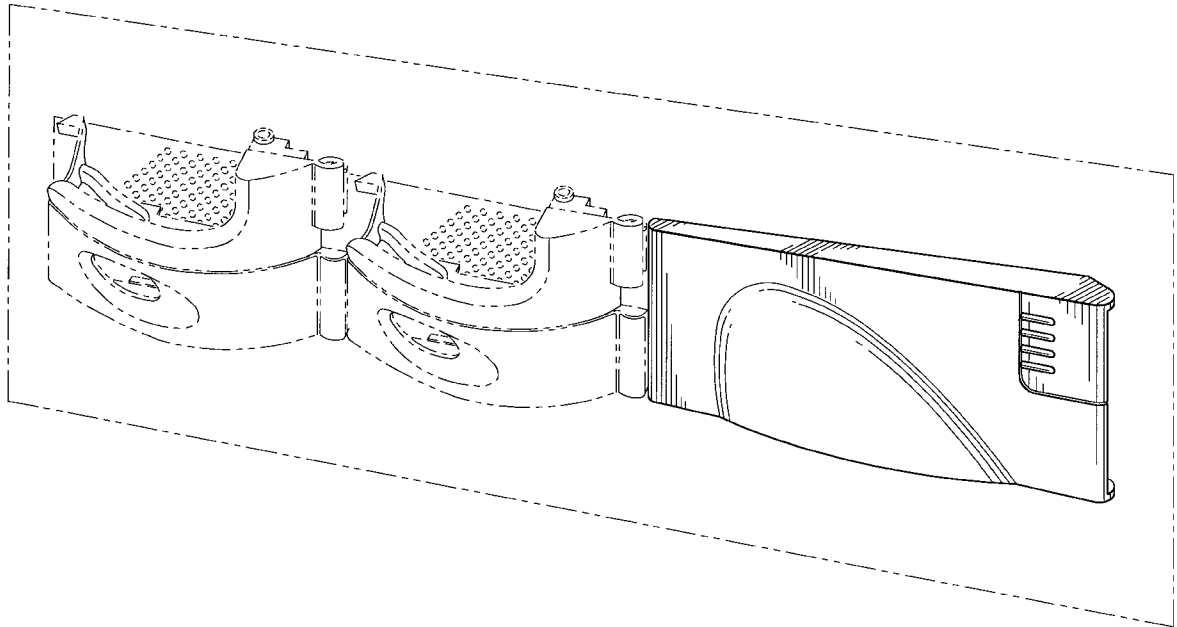

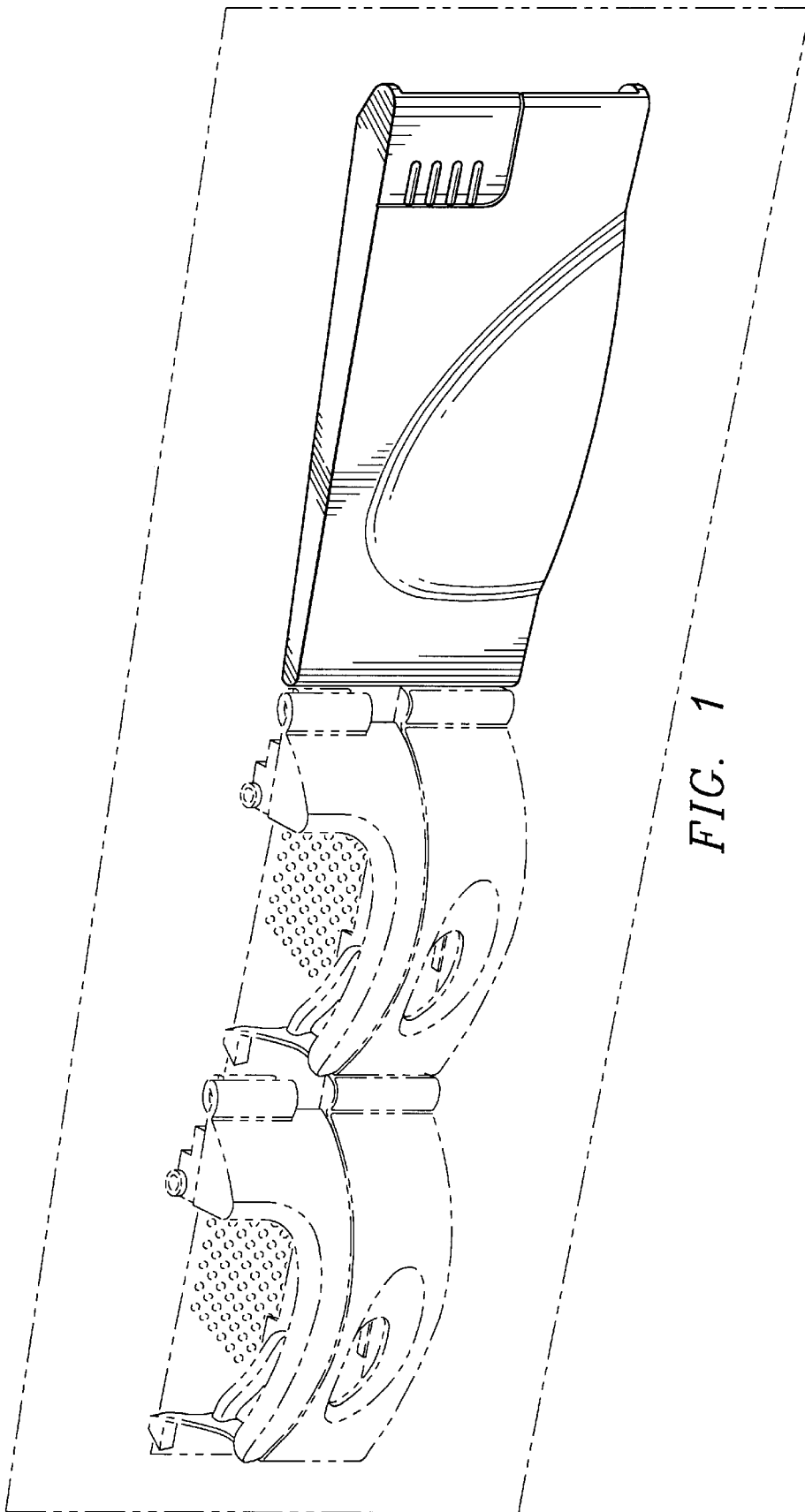

FIG. 1

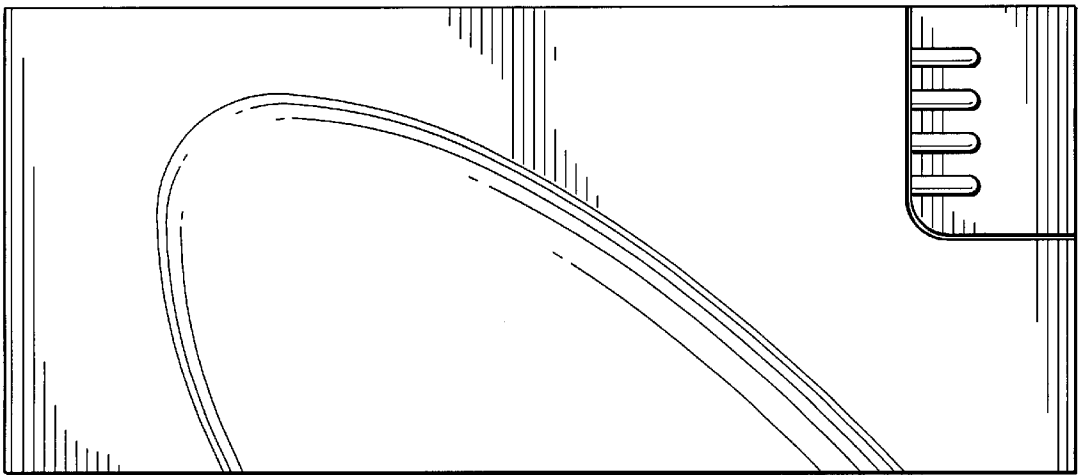

FIG. 2

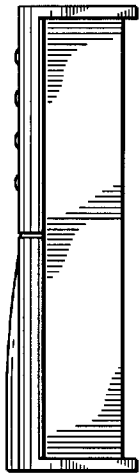

FIG. 3

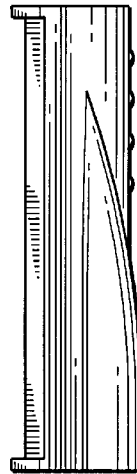

FIG. 4

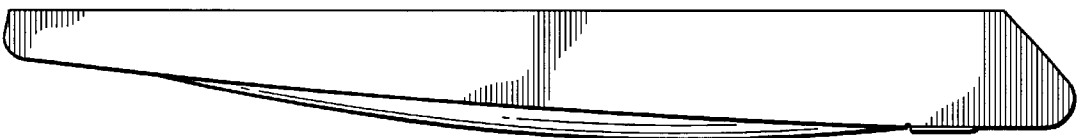

FIG. 5

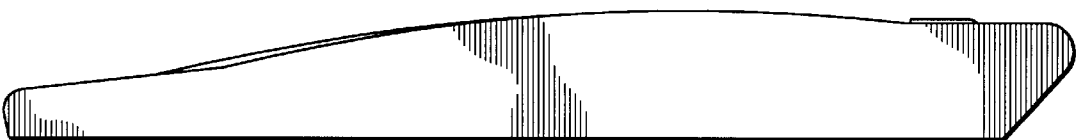

FIG. 6