



(11) **EP 1 763 234 A2**

(12) **EUROPEAN PATENT APPLICATION**

(43) Date of publication: **14.03.2007 Bulletin 2007/11** (51) Int Cl.: **H04N 5/445 (2006.01)**

(21) Application number: **06076885.0**

(22) Date of filing: **20.05.1994**

(84) Designated Contracting States:
AT BE CH DE DK ES FR GB GR IE IT LI LU MC NL PT SE
Designated Extension States:
SI

(62) Document number(s) of the earlier application(s) in accordance with Art. 76 EPC:
04075599.3 / 1 443 756
00200915.7 / 1 028 590
94923877.8 / 0 775 417

(71) Applicant: **United Video Properties Inc.**
Tulsa,
Oklahoma 74136-5422 (US)

(72) Inventors:
• **Alten, Jerry**
Norbeth, PA 19072 (US)
• **Morris, Michael**
Deceased (US)
• **Davis, Bruce**
Lake Oswego, OR 97034 (US)
• **Youman, Roger**
Wayne, PA 19087 (US)

(74) Representative: **Neobard, William John et al**
Kilburn & Strode
20 Red Lion Street
London WC1R 4PJ (GB)

(54) **Improved electronic television program schedule guide system and method**

(57) An electronic program schedule system which includes a receiver for receiving broadcast, satellite or cablecast television programs for a plurality of television channels and a tuner for tuning a television receiver to a selected one of the plurality of channels. A data processor receives and stores in a memory television program schedule information for a plurality of television programs to appear on the plurality of television channels. A user control apparatus, such as a remote controller, is utilized by a viewer to choose user control commands and transmit signals in response to the data processor which receives the signals in response to user control commands. A television receiver is used to display the television programs and television program schedule information. A video display generator receives video control commands from the data processor and program schedule information from the memory and displays a portion of the program schedule information in overlaying relationship with a television program appearing on a television channel in at least one mode of operation of the television programming guide. The data processor controls the video display generator with video control commands, issued in response to the user control commands, to display program schedule information for any chosen one of the plurality of television programs in overlaying relationship with at least one television program then appearing on any other chosen of the plurality of channels on the television receiver.

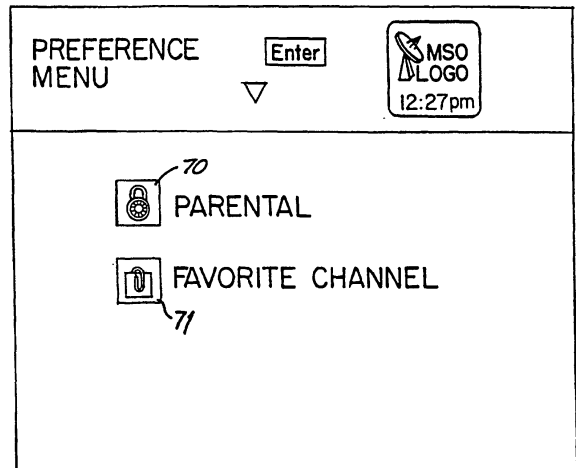

FIG.7

EP 1 763 234 A2

Description

Background of the Invention

[0001] This invention relates to an electronic program schedule system, which provides a user with schedule information for broadcast or cablecast programs viewed by the user on a television receiver. More particularly, it relates to an improved electronic program guide that provides the user with a more powerful and convenient operating environment, while, at the same time, increasing the efficiency of navigation by the user through the guide.

[0002] Electronic program guides for television systems are known in the art. For example, one prior system used an electronic character generator to display textual schedule information on the full screen of a television receiver. Other prior systems presented electronically stored program schedule information to a user for viewing while allowing the user to select display formats. Still other systems employed a data processor to input user-selection criteria, then stored only the program schedule information meeting these criteria, and subsequently used the stored information to automatically tune a programmable tuner or activate a recording device at the time of broadcast of the selected television programs. Such prior systems are generally discussed in "Stay Tuned for Smart TV," published in the November 1990 issue of Popular Science.

[0003] Collectively, the prior electronic program systems may be difficult to implement and cumbersome to use. They also fail to provide viewing capabilities that address in a more realistic manner the viewing habits of the users of these electronic program systems. Moreover, many of these systems are complex in their design and are expensive to implement. Ease of use and economy are primary concerns of television program distributors and viewers as they contemplate dramatic increases in the number and nature of program networks and other television-based services. And, as the number of television channels available to a user increases dramatically with the advent of new satellite and cable-based technologies, the utility of these prior systems substantially diminishes.

[0004] These prior-art systems also fail to provide the user with sufficient information, for example pricing and the like, about pay-per-view events, premium services or other packaged programming to which the user does not subscribe, nor do they provide the user with the capability to automatically purchase such programming on demand or impulse. Moreover, these prior-art systems are deficient in that they fail to provide an efficient and automatic method of updating or replacing the application software programs that implement the electronic guide at the user sites, relying instead on manual or other cumbersome forms of revision or replacement or hardware-based systems that can not be updated without physical replacement of integrated circuits and/or other parts.

[0005] Nor do these prior electronic guide systems

have the capability of linking the user to other applications or information systems which are not part of the electronic program guide application or data.

[0006] Nor do these prior electronic guide systems provide video promotion of television programs and services that are functionally linked and visually displayed in an integrated fashion. Program promotion is an important element of the effective marketing of television programming. The promotion of pay-per-view pay (i.e., "a la carte") programs and other unregulated program services is particularly important to cable television operators in the wake of re-regulation by the federal government. The current method of promoting such programming using video is through dedicated "barker" channels that use full screen continuous trailers (i.e., previews) which may or may not be accompanied by prices and ordering information. Recently, such promotional videos have been shown in split screens where part of the screen shows general schedule information for a time period roughly corresponding to the time period during which the general program being promoted is shown. Accordingly, there exists a need for an electronic program guide which can provide improved display and linking of video promotions with program schedule information and order processing functions.

[0007] The prior electronic program guides also fail to provide the user with a simple and efficient method of controlling access to individual channels and individual programs. The amount of adult situations involving sex and violence has steadily increased during the last 40 years. The issue of how this affects children or other viewers has gained national attention. Providing a parent with the ability to lock-out a channel is a well known and widespread feature of certain television receivers and cable converter boxes. Despite this availability, the feature is seldom used by parents. The main impediments to its effective use are the cumbersome ways in which it is generally implemented, as well as the requirement that entire channels be blocked in order to block access to any objectional programming. A channel-oriented parental lock is unfair to other programmers on the blocked channel -- who, for example, offer adult-oriented programming in the evening and youth-oriented programming the following morning and inconvenient for viewers who want access to such programs. Thus, there is a particular need for a system which provides password control to individual programs and channels using a flexible and uncomplicated on-screen user interface.

[0008] The prior electronic program guides are also deficient in that they do not provide the user with the ability to view on demand current billing status and, thus, a need exists for a system which can provide the user with current billing information on the user's demand.

[0009] An additional problem with prior program guides is that when displaying schedule information in grid format, i.e., columns representing time slots and rows representing channels, program titles generally are width-wise truncated to fit into the cells of the grid. The

width of a grid cell varies with the duration of the program. Since a 30 minute program is allotted only a small amount of space for the program title and description, titles and/or descriptions for half and even full hour programs often must be truncated in order to fit into the allotted space. Some systems simply cut off the description of a program without abbreviating it in any way, such that the user is unable to determine the subject matter of the program. For example, a recent television program display included the following text in a grid cell: "Baseball: Yankees v." Although some systems partially alleviate this problem by providing two lines of text in each grid cell, this solution is not ideal because program descriptions may still be truncated.

[0010] A similar problem arises as the time slots change, either automatically or in response to a user control command. Typically, 90 minutes of schedule information is displayed at one time and the 90 minute window is shiftable in 30-minute increments. In the case where a 30 minute shift causes a 30 minute size grid cell to display, e.g., a two-hour movie, it is likely that the full title of the movie will not fit into the cell. Truncation of the title is thus required in this situation as well. In this case, while two lines of text may be desirable to fit the title in the 30 minute cell, the 60 and 90 minute cells may require only one line of text to display the title.

[0011] The prior electronic program guides also lack a method for creating a viewing itinerary electronically while still viewing a program currently appearing on the television receiver. Moreover, these prior program guides leave much guess work for the user as he navigates through a sequence of channels. When skimming through channels to ascertain the program then being displayed on any channel, commonly known as "channel surfing," the user needs to guess which program is currently being aired from the video encountered as the user surfs through the channels. Since much -- in some cases, up to 30% -- of the programming appearing on any given channel at any given time is advertising or other commercial programming, the user is not provided with any clues as to what program is appearing on a selected channel at a given time and must therefore wait until the advertisement or commercial is over before ascertaining the program then appearing on the selected channel. Thus a need exists for a program guide which displays current program schedule information for each channel as the user surfs through the available channels.

[0012] Accordingly, there is a need in the art for a simplified electronic program schedule system that may be more easily implemented, and which is appealing and efficient in operation. There is also a need to provide the user with an electronic program schedule system that displays both broadcast programs and electronic schedule information in a manner not previously available with other electronic program schedule systems, particularly those using a remote controller.

[0013] For example, there is a particular need for a flexible program schedule system that allows a user to

view selected broadcast programs on a portion of the screen of the television receiver while simultaneously viewing program schedule information for other channels and/or services on another portion of the screen. There is also a need for such a program schedule system that permits the user to select from a plurality of selectable display formats for viewing the program schedule information. It is also preferred to have a system that indicates to the user those keys on the remote controller that are active in any particular mode of operation. There also exists a need for such a system that will give a user the capability to set a programmable reminder for viewing a program scheduled to air at a future time.

[0014] There is also a need for an electronic guide system providing the user with comprehensive information about pay-per-view events, premium services or other packaged programming to which the user does not ordinarily subscribe, and which provides the user with the capability to automatically purchase such programming on demand or impulse. There is also a need for an electronic guide system providing a reliable and efficient method of updating or replacing the application software that implements the electronic guide at the user sites.

[0015] There also exists a need for an electronic program guide that operates as a shell or window to provide the user with the capability to access other applications or information systems that are not part of the electronic program guide application or data.

[0016] It is accordingly an object of the present invention to provide a system that will allow the user to view a broadcast program while, at the same time, interactively viewing program schedule information for other programs.

[0017] It is another object of the present invention to provide the user with the ability to select from among a plurality of display formats for the program schedule information.

[0018] It is yet another object of the present invention to indicate to the user of the program schedule system those keys on the remote controller active in the particular mode of operation of the system at the time of use.

[0019] It is a still further object of the present invention to provide the user of the electronic program schedule system with the capability of setting programmable reminder messages for any future program.

[0020] It is yet a further object of this invention to provide the system user with comprehensive information about pay-per-view events, premium services or other packaged programming to which the user does not subscribe and the capability to automatically purchase such programming on demand or impulse.

[0021] It is another object of the present invention to provide an electronic guide system that provides a reliable and efficient method of updating or replacing the application software programs that implement the electronic guide at the user sites.

[0022] It is still another object of the electronic program guide to operate as a shell or window to provide the user

with the capability to access other applications or information systems which are not part of the electronic program guide application or data.

[0023] It is yet another object of the electronic program guide to provide a system whereby video promotion of television programs and services are functionally linked and visually displayed in an integrated fashion to facilitate the marketing and sale of such programs and services.

[0024] It is still a further object of the present invention to provide password control for access to individual programs, as well as channels, using a protected interactive flexible and uncomplicated on-screen interface.

[0025] Another object of the present invention is to provide the user with current programming information for all programs as the user surfs through the available channels.

[0026] It is yet a further object of the present invention to provide a system in which the user can access his current billing information on demand.

[0027] It is another object of the present invention to provide a system which overlays television program listings against varying background views.

[0028] It is yet another object of the present invention to provide an improved display of text in the grid cells comprising a page of television program listings.

[0029] These and other objects of the invention are achieved by an electronic program schedule system which includes a receiver for receiving broadcast, satellite or cablecast television programs for a plurality of television channels and a tuner for tuning a television receiver to a selected one of the plurality of channels. A data processor receives and stores in a memory television program schedule information for a plurality of television programs to appear on the plurality of television channels. A user control apparatus, such as a remote controller, is utilized by a viewer to choose user control commands and transmit signals in response to the data processor which receives the signals in response to user control commands. A television receiver is used to display the television programs and television program schedule and other information. A video display generator receives video control commands from the data processor and program schedule information from the memory and displays a portion of the program schedule information in overlaying relationship with a television program appearing on a television channel in at least one mode of operation of the television programming guide. The data processor controls the video display generator with video control commands, issued in response to the user control commands, to display program schedule information for any chosen one of the plurality of television programs in overlaying relationship with at least one television program then appearing on any chosen one of the plurality of channels on the television receiver.

Brief Description of the Drawings

[0030]

Fig. 1 is a block diagram showing various components of the preferred embodiment of the invention herein.

Fig. 2 is a block diagram showing the combination of program and schedule information by the video overlay device utilized in the preferred embodiment of the invention.

Fig. 3 depicts a remote controller that can be used in connection with the preferred embodiment of the electronic program guide system of the present application.

Fig. 4 depicts an alternative embodiment of the remote controller shown in Fig. 3.

Fig. 5 shows an overlay appearing on a television screen in one mode of operation of the preferred embodiment of the present invention.

Fig. 6 is a menu that appears on a television screen in a MENU mode of operation of the preferred embodiment of the present invention.

Fig. 6A is yet another menu that appears on a television screen in a MENU mode of operation of the preferred embodiment of the present invention.

Fig. 7 depicts a Viewer Preference Menu that appears on a television screen in one aspect of the preferred embodiment of the present invention.

Fig. 8 shows a Preferred Channel selection submenu.

Fig. 9 shows an impulse ordering menu that appears on a television screen in one aspect of the preferred embodiment of the present invention.

Fig. 10 shows a Premium Services submenu that appears in one mode of operation of the preferred embodiment of the present invention.

Fig. 11 shows a graphic overlay appearing on a television screen in a BROWSE mode of operation of the preferred embodiment of the present invention.

Fig. 12 shows a graphic overlay appearing on a television screen in a BROWSE mode of operation of the preferred embodiment of the present invention having different information from that shown in Fig. 11.

Fig. 12A shows a graphic overlay appearing on a television screen in a BROWSE mode of operation in the present invention displaying schedule information for a time and channel other than that shown in Fig. 11.

Fig. 13 shows a graphic overlay appearing in a REMINDER mode of operation of the preferred embodiment of the present invention.

Fig. 14 shows yet another graphic overlay appearing in a REMINDER mode of operation of the preferred embodiment of the present invention.

Fig. 15 is yet another menu that appears on a television screen in a MENU mode of operation of the preferred embodiment of the present invention.

Fig. 16 is yet another menu that appears on a television screen in a MENU mode of operation of the preferred embodiment of the present invention.

Fig. 17 is yet another menu that appears on a television screen in a MENU mode of operation of the preferred embodiment of the present invention.

Fig. 18 shows a grid listing of schedule information displayed in an All Listings mode of operation of the preferred embodiment of the present invention.

Fig. 19 shows schedule information displayed in a Listings By Category mode of operation of the preferred embodiment of the present invention.

Fig. 20 shows schedule information displayed in a Listings By Channel mode of operation of the preferred embodiment of the present invention.

Fig. 21 shows information displayed in response to a user's request for supplemental programming information.

Fig. 22 shows programming, ordering and video promotional information displayed in a Pay-Per-View mode of operation of the preferred embodiment of the present invention.

Fig. 23 shows an ordering submenu used in conjunction with the mode of operation shown in Fig. 22.

Fig. 24 shows yet another ordering submenu used in conjunction with the mode of operation shown in Fig. 22.

Fig. 24A shows yet another ordering submenu used in conjunction with the mode of operation shown in Fig. 22.

Fig. 25 shows another grid listing of schedule information displayed in an All Listings mode of operation of the present invention.

Fig. 26 shows a Premium Services submenu that appears in one mode of operation of the preferred embodiment of the present invention.

Fig. 27 shows a Messages menu that appears in one mode of operation of the preferred embodiment of the present invention.

Fig. 28 shows exemplary messages used in connection with the menu of Fig. 27.

Fig. 28A is an alternative message menu.

Fig. 29 shows billing information used in connection with the menu of Fig. 27.

Fig. 30 shows a Key Lock Access menu that appears during one mode of operation of the preferred embodiment of the present invention.

Fig. 31 shows a menu appearing in connection with an Interactive Television mode of operation of the preferred embodiment of the present invention.

Fig. 32 shows information that appears in a Quote Watch menu in connection with the Interactive Television mode of operation shown in Fig. 31.

Fig. 33 shows other information that appears in connection with the Interactive Television mode of operation shown in Fig. 31.

Fig. 34 is a menu showing information that appears in a news display in the Interactive Television mode of operation of the preferred embodiment of the present invention.

Fig. 35 is a menu showing information that appears

in a sports display in the Interactive Television mode of operation of the preferred embodiment of the present invention.

Fig. 36 is a flow chart showing the operation logic required for implementation of a computer program for the electronic program guide.

Fig. 37 is a menu showing a Locator screen for locating channel numbers and defining favorite channel lists.

Fig. 38 is an alternative menu that can be used in a MENU mode of operation of the electronic program guide.

Fig. 38A and 38B show, respectively, an alternative main menu screen and a listing-by-time screen accessible from the alternative main menu.

Fig. 39 is a Lockout menu that alternatively can be used for permitting or prohibiting access to certain programs.

Fig. 40 is a Setup menu that can be used to set text location and a purchase code for premium and pay-per-view programming.

Fig. 40A shows an exemplary menu for inputting a lockout code.

Figs. 40B through 40E show, respectively, exemplary menus for entering, confirming, clearing or changing a purchase code.

Fig. 41 is a Lockout Verify menu that is used in connection with the Lockout menu of Fig. 39.

Fig. 42 is a flow chart showing the operation of the preferred embodiment of the text fit system of the invention herein.

DETAILED DESCRIPTION OF THE PREFERRED EMBODIMENT

System Configuration

[0031] Fig. 1 is a block diagram showing various components of the electronic program schedule system generally designated as 10. Physically, these system components can be located in a user's set-top cable converter box or other signal reception or processing device, such as a satellite receiver. Alternatively, the components can be mounted in a separate housing, or included as part of a television receiver, VCR, personal computer, or multimedia player; or reside as a distributed application in a broadband network architecture.

[0032] An input signal 11 is connected to a receiver 12, which receives a transmitted data stream from a data provider. The data stream may contain, for example, information about programs or services available in a particular market, geographical or otherwise. The input signal 11 can originate, for example, as part of a standard broadcast, cablecast or satellite transmission, or other form of data transmission. The data provider is a program information provider, the satellite uplink manager, a local cable operator, or a combination of these sources, and the data stream contains program schedule information

for all television programs and other services available in the operator's geographical market.

[0033] The data stream may be modulated and then transmitted on the cable line in any number of ways, including as part of a dedicated channel transmission operating at a frequency of, for example, 75 MHz. Those of skill in the art will understand that numerous other transmission schemes can be used to transmit the data stream, such as embedding it in the vertical blanking interval of a program broadcast signal. As will be discussed in greater detail below, according to the present invention, the transmitted data stream may additionally contain application software for implementing or updating the electronic program guide at the user site.

[0034] The transmitted program schedule data or application software is received by the receiver 12 on signal input line 11. The received signal is passed from the receiver to a data demodulator 13, such as a QPSK demodulator or a GI Info-Cipher 1000R, which demodulates the transmission and passes it to a buffer 15.

[0035] A microcontroller 16, such as a M68000EC, receives data passed to the buffer 15. Bootstrap operating software, which may be used for capturing electronic program guide application software updates, is stored in a read only memory (ROM) 17. The microcontroller 16 uses the received program schedule information to build a database by storing the data in appropriately organized records in dynamic random access memory (DRAM) 18. The stored schedule information can be updated on a periodic basis, such as hourly, daily or weekly, or at any time when changes in scheduling or other factors warrant an update. The system also includes a system clock 19.

[0036] Alternatively, the program schedule information could be supplied in a ROM, disk or other non-volatile memory, or it could be downloaded to a storage disk or other data storage device. The invention herein is not directed to the particular method of transmission or reception of the schedule information.

[0037] If the microcontroller 16 recognizes the received data as application software which controls the program schedule system, as opposed to program schedule information, it stores it in non-volatile memory, such as an electrically erasable programmable ROM (EEPROM) 20 or battery-backed static RAM (SRAM). This configuration allows revised or replacement versions of the application software to be downloaded directly from the software developer to the user site through the cable or other transmission system.

[0038] In the case where an EEPROM is utilized, revised or replacement versions of the application software downloaded from the developer are first stored in DRAM 18 by the microcontroller 16, under direction of the downloading operating software stored in the ROM 17. The stored application software can then be checked for accuracy by, for example, a checksum analysis or other verification routine.

[0039] After the accuracy of the application software has been verified, the microcontroller 16 initiates a rou-

tine to re-program the EEPROM 20, where the application software is permanently stored. The microcontroller 16 will issue proper control commands to a reprogram circuit 21, which is adapted to supply the proper program voltage and logic control signals 22 required to erase and write to the EEPROM. It supplies this program voltage, Vprog, as well as any other required control signals, such as read or write enable, to the EEPROM 20 upon command from the microcontroller 16. After the EEPROM 20 has been electrically erased, the microcontroller 16 initiates transfer of the new application software from the DRAM 18 to the EEPROM 20 for storing.

[0040] When a battery-backed SRAM is utilized as non-volatile memory, the microcontroller stores the revised or replacement version of the application software downloaded from the developer directly in the SRAM, again under direction of the downloading operating software stored in the ROM. The stored application software can then be checked for accuracy by, for example, a checksum analysis or other verification routine.

[0041] When power is first applied to the system 10, the bootstrap operating software verifies that the program guide application software is resident in memory. If it is not resident, the bootstrap operating software waits for a download of the software. Once the application software is resident, the microcontroller 16 executes the application program software from a dedicated portion of the DRAM 18. Alternatively, the application software can be executed directly from the non-volatile memory 20. Under control of the program guide application software, the microcontroller 16 first verifies that the program schedule information is resident in DRAM 18. If it is not resident, the microcontroller waits for a download of the program schedule information, as discussed above. Alternatively, if the application program is resident in memory, but the database records containing the program schedule information data are not yet available, the application software can be configured to carry out other tasks, such as allowing the user to carry out functions not requiring the program schedule information data, as well as displaying an appropriate message indicating the database data is not yet available.

[0042] When the schedule system is operating, as discussed in greater detail hereinbelow, the microcontroller 16 takes the program schedule information stored in the DRAM 18 and, in conjunction with other downloaded data types such as stored bit maps for the screen configuration and the graphic symbol or logo displays stored in non-volatile memory 20 or, alternatively, in DRAM 18, supplies it to a video display generator (VDG) 23, which in the present embodiment may be a commercially available VGA-type graphics card, such as a Rocgen card manufactured by Roctec. The VDG includes a standard RGB video generator 24, which takes the digital program schedule information sent by the microcontroller 16 and converts it to an RGB format in accordance with the bit map for the particular screen display then being presented to the user on the television receiver 27. The config-

uration of each screen is shown and discussed in greater detail in the System operation section below.

[0043] The VDG also includes a Video Overlay Device 25, which accepts the RGB video input, as well as an input from conventional television tuner 28, such as a conventional tuner manufactured by General Instrument or a Jerrold DPBB tuner, which supplies a program signal in standard NTSC video format. The overlay device 25 converts and combines the RGB signal with the signal from the tuner 28, and produces a composite NTSC output signal containing both the program signal and the program schedule information, as shown in Fig. 2. This composite video signal is supplied to a modulator 26, shown in Fig. 1, which can be a modulator such as available from Radio Shack, and then to the television receiver 27, which the user keeps tuned to the modulated channel, for example, channel 3 or 4. The composite video signal can also be supplied directly to the television receiver 27 or other receiving device from the VDG through a video port 25A on the VDG.

[0044] The system components identified in connection with Fig. 1 can all be implemented in a preferred platform by, for example, an IBM personal computer equipped with a transmission link and a video graphics card, such as those manufactured by Roctec. Other platforms, such as a cable converter box equipped with a microprocessor and memory, or a broadband network also could be used. Examples of the particular components are as follows: Microcontroller -- Motorola part no. MC68331-16; ROM -- Texas Instruments part no. TMS27PC512; DRAM -- Texas Instruments part no. TM4256; EEPROM -- Intel part no. 28F001BX-T. In any event, those of skill in the art will appreciate that the particular details of the hardware components and data storage are a function of the particular implementation of the system, and are not the subject of the present invention.

[0045] As discussed in detail below, the user may navigate through the program schedule system with a remote controller, such as that shown in Fig. 3, which operates on conventional principles of remote control transmitter-receiver logic, such as by infrared or other signalling, or other suitable user interface. The remote controller 31 communicates with the microcontroller 16 through the remote controller receiver 29, shown in Fig. 1, which can be a Silent Partner IR receiver and which receives signals transmitted by the remote controller 31 and supplies the microcontroller 16 with a corresponding digital signal indicating the key depressed by the user.

[0046] A remote controller suitable for the present invention, such as shown in Fig. 3, which can be a remote controller manufactured by Universal Electronics or Presentation Electronics' Silent Partner, may include a power switch 32, volume 33 and mute 34 controls, an ENTER key 35, 0-9 digit keys 36, four direction arrow keys 37A and 37B, a MODE key 38 and an information key 39 that is designated with a lower case "i." The power 32, volume 33 and mute 34 keys operate in the same manner as conventional remote controllers typically used

with present-day television receivers. The numeric digit keys 36 also function in much the same manner as conventional remote controllers. A brief description of the remaining keys follows.

5 **[0047]** The MODE key 38 takes the user through various layers of the electronic program schedule system 10 and generally allows the user to return to a previous screen when he is in a submenu. The up/down direction arrow keys 37A allow a user to navigate through the different TV program channels when the program schedule system is in a FLIP or BROWSE mode, as will be fully described below, and also allow the user to navigate through highlighted bars displayed on the TV screen when in a MENU mode. The left/right direction arrow keys 15 37B allow the user to navigate through selected time periods when the program schedule system is in the BROWSE mode, as will also be described below. They further allow the user to navigate across subject-matter categories while in the "Categories" submenu of the MENU mode, as well as to navigate across time periods when the program schedule system is in a pay-per-view ordering mode and, in general, navigate in left or right directions to select various icons and other objects. The information, or "i," key 39 allows the user to view supplemental program and other information during the various 25 modes of the program schedule system. The ENTER 35 key fulfills and inputs a command once the user has made a selection from the remote controller keys. The function and operation of these keys will be made more apparent in the detailed discussion of the FLIP, BROWSE and MENU modes below.

30 **[0048]** A second embodiment of the remote controller 40 is shown in Fig. 4. This embodiment of the remote controller also includes a power key 41, numeric digit keys 42, direction arrow keys 43A and 43B, information key 48, ENTER or SELECT or "OK" key 44, volume control 45, lockout key 45A, mute keys 46 and help key 48A. It also includes pound sign and star keys.

35 **[0049]** This embodiment of the remote controller further includes a number of icon keys 47A and 47B, which correspond to different submenus or modes of the program schedule system. The icons 47A and 47B may also be displayed on the TV screen when the program schedule system is operating. The icon keys essentially replace the MODE key 38 used in the embodiment of the remote controller shown in Fig. 3. Using these keys, the user can move from one mode to another simply by depressing the icon key corresponding to the desired mode of operation of the program schedule system. In the embodiment of Fig. 4, the icons 47A and 47B are shown as graphic symbols situated directly above a corresponding color-coded key. Alternatively, the color-coded keys could be eliminated and keys could be formed in the image of the icon itself.

40 **[0050]** The embodiment of the remote controller shown in Fig. 4 also includes three color-coded viewer preference or favorite channel keys, 48A, 48B and 48C that are situated directly above the icon keys. Each of

these keys indicates to the program schedule system a distinct user-created "Channel Preference" or "Favorite Channel" list, which is a listing of a specific subset of channels for a particular user, arranged in the sequential order that the user wishes to view during operation of the program schedule system. The creation of the Channel Preference or Favorite Channel list is discussed in the following section. Thus, the system provides for at least three individual channel subsets for three individual users.

[0051] The remote controller of Fig. 4 also may be equipped with a "HELP" key 48A, which, when depressed, causes the microcontroller 16 to retrieve previously stored instruction messages from memory and cause them to be displayed on the television receiver 27. These messages offer help to the user in the form of instructions that guide the user through the operation of the various operating modes of the electronic television program guide. They may be text messages, or instructional video images, or audio programs, depending on the storage capacity of the system, or any combination of these. Moreover, these help messages may be created so that they are context-sensitive, i.e., the messages displayed depend entirely upon the precise point in the operation of the electronic program guide that the user depresses the help key 48A. For example, information could be supplied for operation of the remote controller, for operating the FLIP or BROWSE mode (discussed below), or any other mode of operation of the guide, for impulse ordering, for setting a lockout, etc. In order to accomplish this, each point of operation of the guide could be coded so that the microprocessor could track the current operating point, for example, by temporarily storing the code reflecting the present operating point as the user operated the guide. When the user pressed the help key 48A, the microcontroller 16 would retrieve an appropriate set of messages based on the presently stored operating point code. Additionally, the i key 39 could be used to carry out the function of the help key.

[0052] Additionally, each of the functions of the remote controllers can also be integrated into a keypad on the user's cable box or other hardware.

System Operation

[0053] In operation, the electronic program schedule system of the present invention functions as follows.

FLIP Mode

[0054] When the user is viewing a particular program channel on the television receiver, the program schedule system defaults to a FLIP mode, shown in Fig. 5. In this mode, a graphic overlay 51 containing programming information for the channel currently tuned on the tuner is superimposed in overlaying relationship with a received program signal 55 on the screen of the television receiver 27 whenever the viewer changes the program channel,

for example, by using the up/down direction arrows on the remote controller. The video overlay device 25, such as shown in Fig. 1, combines the computer-generated RGB video-graphic overlay information with the NTSC-format program signal from the tuner 28, and supplies an NTSC-format output signal, which includes the program signal from the tuner and the program schedule overlay information for viewing on the television receiver 27.

[0055] The programming information contained in the graphic overlay 51 is supplied to the RGB video generator by the microcontroller. In FLIP mode, the microcontroller first searches the program schedule database in, for example, the DRAM 18 to retrieve the programming information for the currently tuned channel 52 corresponding to the current time; i.e., the time at which the user just turned on the television receiver for viewing. The microcontroller 16 then supplies the current channel and program information to the RGB video generator 24 which converts the digital data information to RGB format and supplies it to the video overlay device 25.

[0056] In normal operation, the microcontroller 16 defaults to displaying all channels offered by the cable company prioritized by numeric order, which is determined by the broadcast channel position in the radio spectrum or the marketing judgments of local cable operators. Using a "Channel Preference" submenu, or an alternative "Locator" screen, both of which are discussed below, the user can revise the content and/or sequential order of the channels presented to the television receiver 27.

[0057] In general, if the user does not issue a change-channel instruction, or other command, from the remote controller 40 within a predetermined time interval while in the FLIP mode, the microcontroller 16 instructs the VDG 23 to remove the graphic overlay 51 from the television receiver, thus presenting only a program signal 55 to the television receiver 27 for viewing. The duration of the predetermined time interval is such that it allows the user sufficient time to read the programming information contained in the overlay. The duration of the predetermined time interval during which the graphic 51 overlay appears is stored in a location in non-volatile memory 20 addressable by the microcontroller 16. The user can change the duration of the time interval, by first entering a Viewer Preference mode, and then selecting an "overlay interval" entry. The microcontroller 16 then causes a user prompt to be displayed on the screen which, for example, asks the user to select an appropriate time period for displaying in the graphic overlay on the screen. Using the numeric keys, the user can input an appropriate response, for example, a period between 5 and 60 seconds, and then depress ENTER. The new interval period is then read and stored by the microcontroller 16 in the overlay time interval location in memory.

[0058] If the user issues a change-channel command from the remote controller 40 before or after the predetermined overlay period has elapsed, either by using the up/down direction arrows 43A, or by entering a desired

channel number using the numeric keys 42 and then depressing the ENTER key 44, the microcontroller 16 will cause the tuner 28 to tune to the desired channel either the channel immediately preceding or following the current channel when the up or down arrow 43A is used or the specific channel entered on the numeric key pad by the user -- and will also search for and immediately cause to be displayed the current program information for that channel. Thus, as the user flips through the channels, the program schedule information for any selected channel automatically appears in the graphic overlay 51 while the actual program 55 appearing on the selected channel at the particular time occupies the remainder of the screen.

[0059] The system can also be configured to issue an error message, such as an audible beep or displayed text indicating an invalid key stroke, if the user depresses either the left or right direction arrow keys while in the FLIP mode.

BROWSE Mode

[0060] To initiate the BROWSE mode, the user depresses the MODE switch once while in the FLIP mode when using the first embodiment of the remote controller 31 shown in Fig. 3. Utilizing the second embodiment of the remote controller 40 shown in Fig. 4, the user would depress the button below the BROWSE icon 47A.

[0061] In the BROWSE mode, the user is provided with the ability to scan through program schedule information for any channel, including, but not limited to, the channel being viewed, while at the same time continuing to view the TV program previously selected. As shown in Fig. 11, in this mode the graphic overlay information that appears in the FLIP mode is replaced with programming information for the channel being browsed, which may or may not be the channel currently being viewed by the user. After the user issues the command from the remote controller 40 to enter the BROWSE mode, a graphic overlay 111 is generated, as in the FLIP mode, with program schedule information for the currently tuned channel 112 and a textual BROWSE indicator 113 to remind the user of the currently active mode, as shown in Fig. 11.

[0062] If the user depresses either the up or down direction arrow on the remote controller 40 while in the BROWSE mode, program schedule information for either the prior or next channel is displayed in the graphic overlay portion 111 of the television receiver screen 27, while the tuner remains tuned to the channel program that appeared on the television receiver at the time the user entered the BROWSE mode, as shown in Fig. 12, and continues to so appear. Each successive depression of the up or down direction arrow key produces corresponding program schedule information for the selected channel. The graphic overlay may also include a small video window for showing the actual video signal of a currently aired program or a clip of a future program corresponding to the schedule information then appearing in the

BROWSE overlay. In this way, the user can simultaneously scan program schedule information for all channels while continuously viewing at least one selected program on the television receiver. With the advent of sophisticated television receivers, it may also be possible to simultaneously display multiple broadcast programs on a single screen for viewing, or to split the screen to show, for example, broadcast programs in combination with advertisements. The BROWSE feature could be used in any of these situations.

[0063] If, at any time during scanning of the program schedule information in the BROWSE mode, the user desires to tune the television receiver 27 from the program channel currently being viewed to the program channel indicated in the schedule information in the graphic overlay, he simply depresses the ENTER button 44 and the tuner 28 will be tuned to that channel. If the user does not want to view another channel and wishes to exit the BROWSE mode, thus removing the graphic overlay 111 with the program schedule information, he must depress the MODE key twice in the first embodiment of the remote controller 31. The first depression of the MODE key takes the user to the MENU mode, discussed below, and the second depression will take the user to the FLIP mode. Once in the FLIP mode, the graphic overlay will be removed after the duration of the timeout interval has passed. In the second embodiment of the remote controller shown in Fig. 4, the user toggles the BROWSE icon key to deactivate the BROWSE mode.

[0064] When the user first enters the BROWSE mode and begins scanning channels, the schedule information appearing in the overlay portion 111 describes the programs currently playing on any particular channel. In order to view programming information for later or earlier times, the user employs the left and right direction arrows 43B. As a consequence, the system will display future program schedule information for the particular channel previously selected by the up and down direction arrows, whether it is the channel currently being viewed or any other available channel. The schedule information presented includes the name of the program and program start/stop time. The instant embodiment of the system, in order to conserve memory, will not allow the user to view programming information for a time prior to the current time. The system could be easily modified to provide such information if adequate memory is made available. It may be desirable, for example, to allow a user to view schedule information for an earlier time to find a particular show and then allow the user to command the microcontroller to find and display future airing dates of the show, or the microcontroller could simply do this automatically.

[0065] When viewing program schedule information for a future time in the BROWSE mode, the displayed time of airing 121 of the particular show 122 is highlighted, as well as the channel number and service indicator 123, as shown in Fig. 12A. Such highlighted information reminds the user that he is viewing program schedule information for a future time. Also, when viewing program

schedule information for a future time on any particular channel in the BROWSE mode, depression of the channel up direction arrow key on the remote controller 40 causes programming schedule information for the next channel to appear, which corresponds in time to the future time that was being viewed before the up key was depressed by the user. The channel down direction arrow key 43B functions identically in this mode.

[0066] If while viewing program schedule information for a future time in BROWSE mode the user depresses the ENTER key on the remote controller, the microcontroller 16 will instruct the VDG 23 to display a REMINDER overlay message 130 which, as shown in Fig. 13, is displayed as a second overlay 131 appearing above the BROWSE overlay 132. The REMINDER message 130 queries the user as to whether the system should remind the user, at a predetermined time before the start of the selected program, that he or she would like to view the selected program, as shown in Fig. 13. If the user responds affirmatively, the microcontroller 16 stores reminder data consisting of at least the channel, time and day of the selected program in a reminder buffer, which contains similar schedule information for all programs for which the user has set a reminder. At a pre-determined time before the selected program start time, for example, five minutes, the microcontroller 16 will retrieve schedule information, including title and service, based on the reminder data, and will instruct the VDG 23 to display a REMINDER overlay message 140 on the television receiver 27, as shown in Fig. 14, to remind the user that he or she previously set a reminder to watch the selected program. The REMINDER message 140 contains the channel, service and start time. It also displays the number of minutes before the time of airing of the particular show and updates the display every minute until the time of airing. The REMINDER message 140 also displays a "TUNE" inquiry, which asks the user if she would like to tune to the selected program. When the user sets multiple reminders, the reminder overlays are stacked, for example, in ascending order according to the time each reminder is scheduled to be displayed, and the next reminder message will appear on the television receiver after the user takes appropriate action to remove the reminder message then being displayed. The REMINDER message (140 could also be adapted to allow the user to display or modify a list of all reminders previously set by the user. As with the overlay display time period in the FLIP mode, the user can modify the time period before a selected program that the REMINDER message appears by entering the Viewer Preference mode and revising the time entry.

MENU Mode

[0067] Using the remote controller 31 shown in Fig. 3, the user can enter the MENU mode from the BROWSE mode or from the FLIP mode by toggling the MODE button 38 once or twice, respectively. Using the remote con-

troller 40 of Fig. 4, the user would simply depress the key 47B corresponding to the MENU icon.

[0068] Referring to Fig. 6, in the MENU mode, the system displays a plurality of menu items and icons, which correspond to and allow user selection of distinct program schedule information display formats, local cable system message boards and other on-line information services. The MENU screen shown in Fig. 6 is a full-screen display. In the embodiment shown in Fig. 6, there are four vertically selectable horizontal bars 61-64, which are accessed using the up and down direction arrows 43A on the remote controller 31 or 40. At the extreme left of each bar, an identifying icon 61A-64A is displayed, which identifies the information contained in that bar. In the embodiment of Fig. 6, the "TV GUIDE" icon 61A in the first bar corresponds to program schedule information from TV Guide® magazine, the "NOW SHOWING" icon 62A in the second bar 62 corresponds to pay-per-view and premium service events, the "MSO Logo" icon 63A in the third bar 63 corresponds to Customer Service or local cable company information messages, and the circular icon 64A in the fourth bar 64 corresponds to other interactive services available to the user, or in the case of broadband networks, other venues, e.g., home shopping, banking or telephone use. As also shown in Figs. 6 and 6A, each bar also contains a textual description of its contents.

[0069] When the user first enters the MENU mode, the system defaults to selection of the program schedule bar. When a particular bar is selected, the textual description is removed and a plurality of icons or identifying windows are displayed adjacent the identifying icon. In Fig. 6, the program schedule bar 61 is selected. Using the up or down direction arrow key on the remote controller 40, the user selects a vertically adjacent bar. Figs. 15-17 show, respectively, selection of the Pay-Per-View bar 62, the Customer Service or Messages bar 63 and the Interactive TV services bar 64.

[0070] An alternative MAIN MENU screen 215 is shown in Fig. 38. Certain selection screens accessible from the menu shown in Fig. 38 are shown in Figs. 38A and 38B. It has three horizontally selectable bars: program schedule 205, Home Theater 206 and Customer Service 207. The MAIN MENU screen 215 also contains an additional "Locator" identifier, which is described below.

[0071] Once a particular bar in the MENU screen is selected, the user can select a particular icon from the plurality of horizontally selectable displayed icons 65A-65C by using the left or right direction arrow and the ENTER key on the remote controller 40. Each icon contains a graphical symbol appearing in a background window of a particular color. When a particular icon is selected, it is offset from its background window and the color of the window changes. In Fig. 6, the grid icon 65A immediately adjacent the "TV GUIDE" icon in the first bar 61 is selected.

[0072] The function corresponding to the selectable

entries in the MAIN MENU screen will now be discussed with reference to Fig. 6. It will be appreciated by those of skill in the art that the same functionality applies in the categories shown in the MAIN MENU 215 shown in Fig. 38.

[0073] In the uppermost vertically selectable horizontal bar 61, the first grid icon 65A represents an "All Listings" mode in which the program schedule information is displayed in a grid listing, such as that shown in Fig. 18. Alternatively, a single column grid-like display could be used, as that shown in Fig. 25. In this format, the vertical y-axis identifies the channel number and service while the horizontal x-axis identifies the time. The screen display of Fig. 18 also contains in the upper left-hand corner a mode identifier 180, in this case the notation "All Listings," to remind the user of the current operating mode of the system. Directly underneath the mode display is a highlighted display 181 of the channel that the user was watching before entering the MENU mode. In the upper right-hand corner, a logo icon 182 appears in a window directly above a date/time identifier 183, which alternatively displays the current date and time.

[0074] In the center of the screen display shown in Fig. 18 is a graphical Active Key Display (AKD) 184 which indicates to the user those keys on the remote controller that are active for that particular mode of the program guide display system. For example, in the screen display of Fig. 18, the cursor can only move up, down or to the right. If the user were to depress the left direction arrow key on the remote controller at that point, the system would not carry out any function since the cursor can not move to the left. Thus, the left arrow key is not active so its image is not displayed on the AKD 184. Similarly, since the system will only respond to a depression of the up, down or right direction arrow keys and the ENTER key, they are the only key images displayed on the graphical AKD 184. The MODE key, though not displayed, is always active to change from one mode to another. When the user first enters the All Listings guide, the time listing begins by default at the half-hour immediately preceding the current time unless the current time is on the hour or half-hour, in which case the display begins with the particular hour or half-hour, and the channel listing begins at the last channel being viewed by the user before entering the MENU mode. For example, in Fig. 18, the current time is displayed as 7:13 p.m., the time listing begins at 7:00 p.m. and the channel listing begins with channel 4.

[0075] In the All Listings mode, a moveable highlighted cursor 185 is used to indicate the currently selected program to the user. The user manipulates cursor movement using the direction arrow keys on the remote controller 40. Furthermore, the entire information display pages upward if the cursor is placed at the bottom of the screen and the down direction arrow is depressed, and similarly pages to the left if the cursor is at the extreme right side of the display and the right direction arrow is depressed. In this way, the user can navigate through the entire program schedule.

[0076] The folder icon 65B immediately to the right of the All Listings icon in the top horizontal bar 61 of Fig. 6 identifies a "Category Listing" mode in which program schedule information is displayed and categorized by program content, as shown in Fig. 19. The particular listing shown in Fig. 19 includes the categories of Movies, Sports, News and Children 190A-190D. The database record stored for each listing contains a content-specific identifier so the microcontroller can search the database and categorize the information by content for purposes of displaying it in the category Listing mode. As shown in Fig. 19, the user can manipulate the cursor left or right to highlight any one of the categories which appear at the head of the listing. In Fig. 19, the "Movies" category 190A is selected. As shown, the user is given a display of all movies, prioritized by time and then alphabetically by title of show, beginning with the half-hour immediately preceding the current time unless the current time is on the hour or half-hour, in which case the display begins with the particular hour or half-hour. The screen display shown in Fig. 19 also includes a textual description of the current operating mode of the program schedule system, as well as the graphic AKD 184, similar to that used in connection with the All Listings mode.

[0077] As with the All Listings mode, if the user highlights a show which is currently airing, he can immediately tune to that show by depressing the ENTER key on the remote controller 40. If the highlighted show is one that will appear at future time, the user is again given the option of setting a REMINDER message.

[0078] The triangular icon 65C at the far right of the TV GUIDE bar 61 in the display of Fig. 6 identifies a "Channel Listing" mode in which the program schedule information is categorized and displayed by channel, as shown in Fig. 20. The screen display shown in Fig. 20 again includes a textual mode identifier 201, the graphic AKD 184, and the window including the logo icon 182 and alternating time/date display 183. At the head of the program listing is a list of several consecutive channels 202A-202C beginning with the last channel viewed by the user before entering the Channel Listing mode. The channel in the middle window 202B is highlighted and is the channel for which schedule information is displayed. The display identifies those programs appearing on the highlighted channel beginning with the half-hour immediately preceding the current time unless the current time is on the hour or half-hour, in which case the display begins with the particular hour or half-hour. The user can display further future listings by manipulating the cursor to the bottom of the screen and paging the display, as previously described. The user can also change the selected channel by manipulating the left or right direction arrow keys on the remote controller 40. When the user issues a change-channel command in this manner, the next consecutive channel will be displayed in the highlighted window 202B in the channel string at the head of the display, and schedule information for the newly selected channel will be displayed on the television receiver

27.

[0079] As with other modes, if a user wishes to tune to a highlighted program that is currently airing, he can do so by simply depressing the ENTER key on the remote controller 40, and if the user wishes to view a program that airs at a future time, the user is again given the option of setting a REMINDER message.

[0080] In each of the FLIP, BROWSE and MENU modes, a lower case "i" icon appears at a number of occasions in connection with certain program listings, such as movies, such as the "i" 203 shown in Fig. 20. Any time this icon appears, the user can view additional programming information, generally comprising a textual description of program content and/or other information related to the program, such as the names of cast members and the like, by depressing the "i" key 48 on the remote controller 40. An example of a display of such additional information is shown in Fig. 21.

[0081] The second horizontal bar 62 appearing on the screen in the MAIN MENU mode shown in Fig. 6 is the "Home Theater" Listing. It corresponds to Pay-Per-View events or services, specialized programming, and Premium service programs. When this category is chosen by the user, the television receiver displays information as shown in Fig. 15. The first theater-ticket icon 150 that appears in this Home Theater bar identifies a format in which the Pay-Per-View events and premium services are displayed, as shown in Fig. 22. As with other modes, the user can manipulate the cursor to highlight and select any particular show. Also, the user can obtain additional information about the Pay-Per-View event or service by depressing the "i" key 48 on the remote controller 40. The Pay-Per-View menu screen display shown in Fig. 22 also includes a video display section 220 in which short promotional clips of current and future events and services can be shown to the user while the user is viewing the Pay-Per-View scheduling information. The display of Fig. 22 is bit mapped such that the advertising clips may be shown in the lower left quadrant of the screen. The clips may be shown randomly in the video display section 120 or, alternatively, the clip shown could correspond to the particular selected entry on the list of events, and would change automatically as the user navigated through the list.

[0082] When a user highlights a Pay-Per-View event or service by manipulating the cursor to the desired event or service using the direction arrow keys on the remote controller 40, he can order the event or service by depressing the ENTER button on the remote controller, thus linking schedule, promotional and ordering functions. If the user selects a particular Pay-Per-View event or service in this manner, the programming schedule system will next present to the user a Pay-Per-View ordering screen such as that shown in Fig. 23. The display includes a figure representing the cost of the event or service. The display also asks the user to choose from among a plurality of scheduled airing times 230A-230C, as well as whether the user would like to see a REMINDER mes-

sage prior to the start of the Pay-Per-View event or service. The user responds to these inquiries by using the direction keys on the remote controller 40 to manipulate the cursor to the proper response and then depressing the ENTER key. After the user has ordered a Pay-Per-View event or service, the program schedule system will present the user with two ordering confirmation submenus, such as shown in Figs. 24 and 24A. In either of these submenus, the user can confirm or cancel the Pay-Per-View event or service.

[0083] If the user confirms the order, the microcontroller 16 stores the Pay-Per-View ordering information in a location in memory. The ordering information can then be transmitted to the cable operator by the microcontroller 16 either by phone line or on the cable line where the system has two-way communication or other such interactive capability. Alternatively, a computer at the cable operator location can interrogate the memory where the microcontroller stored the Pay-Per-View ordering information. At the appropriate time, the cable operator supplies the Pay-Per-View event or service and it is received by all users who have ordered the program.

[0084] The second icon 151 in the Pay-Per-View bar of Fig. 15 identifies a specialized broadcast, cable or satellite programming service to which the user has access via the electronic program guide. In this mode, the electronic program guide application software acts to connect the user, through an appropriate data transmission link, to the programming service, at which point the user interacts with the service. Alternatively, the electronic program guide provides the navigation software, including the menus and scheduling information, for the particular programming service. Such a service could be, for example, Your Choice TV ("YCTV"), a service offering reruns of highly rated broadcast and cable programs, in which case the icon may take a form suitable to identify YCTV. The programming available on YCTV is then supplied to the user via the programming guide system.

[0085] The last icon 152 appearing in the Pay-Per-View bar of Fig. 15 identifies a display format which lists all Premium Services offered by the cable operator, as shown in Fig. 26. In this mode, the user can select for impulse ordering any one of the premium services by manipulating the cursor using the direction arrow keys on the remote controller and depressing the ENTER key. Similar to Pay-Per-View ordering, the system will present the user with a series of ordering displays and, if a service is ordered by the user, it will confirm the user's request using another other submenu. If confirmed, the microcontroller 16 will store the ordering information or transmit it directly to the cable operator. Once the order has been confirmed, the microcontroller can immediately allow the user access to the ordered premium service. In this manner, the user can order premium events or services on demand.

[0086] If, during FLIP or BROWSE modes, a user views a channel or schedule information for a service not subscribed to by the user, the microcontroller 16 causes

an ordering submenu to appear instead of displaying a program signal along with the graphic overlay, as shown in Fig. 9. This submenu indicates to the user that she does not currently subscribe to the selected service, and then asks the user if she would like to order the service. If the user responds affirmatively, the program schedule system takes the user to the ordering submenu discussed above. In this manner, the user can order premium events or services on impulse.

[0087] The third horizontal bar 63 in the MENU mode shown in Fig. 6 is the "Messages" or "Customer Service" listing. As shown in Fig. 16, the first envelope icon 160 represents message information available from the cable operator. When the user selects the message icon, he is presented with a screen display of currently available messages, as shown in Fig. 27. The display shown in Fig. 27 includes cable system messages 270 and billing information 271. If the user selects the cable system messages option 270, she is presented with a message pertaining to the local cable operator, such as that shown in Fig. 28. If the user selects the billing status option 271 shown in Fig. 27, she is presented with a display of current billing information, such as that shown in Fig. 29. This information may include a history of purchases charged to the user, current balance information, pending orders, and, an indication of available credit, which can be an authorized debit limit previously arranged with the cable or other operator. Thus, a user could specify only a certain pre-set spending limit. Once the amount of charges from pay-per-view events reaches the limit, the microcontroller would not permit further ordering of events. An alternative messages menu is shown in Fig. 28A.

[0088] The next icon 161 in the Customer Service information bar 63 of Fig. 16 identifies a "Viewer Preference" mode, which allows the user to create or revise a number of program schedule system operating parameters. Once selected, this display presents the user with several preference options concerning certain operating parameters of the program schedule system, as well as the viewing of certain channels and/or certain content-specific programming, for example, those shown in Fig. 7.

[0089] The first option shown in Fig. 7 is the "Parental" option 70, which can also be expressed as a "Key Lock Access" option. Once this option is initially selected by the user, the system displays a "Key Lock Access" submenu such as that shown in Fig. 30.

[0090] The Key Lock Access menu shown in Fig. 30 allows the user to control access to individual channels and programs or events by requiring the user to enter an access code "key," consisting of a user-specified four digit code in the specific embodiment discussed herein, before ordering or viewing these pre-selected channels, programs or events. The menu display shown in Fig. 30 shows a series of subject categories that are entries in the vertical y-axis selectable by the user. A particular subject category is chosen by using the up or down direction arrow keys on the remote controller 40 to highlight

the desired entry. Once the user selects a particular subject category, the left and right arrow keys are used to navigate within the chosen category.

[0091] The first subject entry shown in Fig. 30 is the "Parental Guidance" category 301. Once the user selects this category by manipulating the cursor to highlight the entry, the cursor can be then moved horizontally to an active window 302 which displays and selects one the five letter rating items in the category. The letter items represent ratings of program content as follows: "V" for violence, "N" for nudity, "L" for language, "AS" for adult situations and "PD" for parental discretion. Once the user selects a particular item, such as "L", by moving to the active window 302 using the right direction arrow key, depressing the ENTER key will indicate to the microcontroller 16 that a key lock access has been selected for programs rated with a "L" rating for violent or explicit language. The system indicates activation of a key lock access by displaying a key icon directly below the "L" category display. Once a key lock access is set, it can be deactivated by selecting the category letter and then depressing the ENTER key. This action causes the key icon to disappear. The user can change the rating category in the active window 302 by using the left or right direction arrow keys on the remote controller 40, images of which are displayed on the screen adjacent the active window as a reminder to the user. In this manner, the user can select other rating categories for setting a key lock access for any of the program content identifiers appearing in the Parental Guidance category.

[0092] The key lock access code itself consists of a four digit code, which the user can enter and modify at any time. To do so, the user highlights the fourth vertically selectable entry "Change Key Lock Access Code," 304 by manipulating the cursor to highlight it using the direction arrow keys on the remote controller. Once highlighted, the user enters a new four digit code or revises the then existing code and depresses the ENTER key. The microcontroller 16 then identifies the new four digit key lock access code and stores it in memory. The user can clear the key lock access code, as well as all other previously activated keys, by moving to the last entry in Fig. 30, "Clear Key Lock Access Code and All Keys," 305 which highlights the "OK" window, and then depressing the ENTER key. This action clears and deactivates all previously set keys, as well as the key lock access code.

[0093] The schedule information database record for each program contains a field that corresponds to the program content identifiers in the Parental Guidance category. During operation, the microcontroller checks this field in response to a user command to tune to or order a program, or to display its corresponding schedule information before carrying out the tuning, ordering or displaying function. If the parental guide identifier in the program schedule information database record matches any one of the activated parental guidance identifiers shown in Fig. 30, the user will be prompted to enter the four digit key lock access code before the system takes any further

action. If the entered code matches the key lock access code previously entered and stored by the user as described above, the system will carry out the user request to tune to the program, to order it, or to display its corresponding schedule information. If the code is not recognized by the system, no further action will be taken and the user's request will be denied.

[0094] By manipulating the cursor using the direction arrow keys to highlight the second entry, "MPAA ratings," 308 the user can also set a key lock access for programs based on their MPAA rating code, as also shown in Fig. 30.

[0095] As with the Parental Guidance category, once the MPAA rating category has been selected, the user can move horizontally within the category to the active window 306 to select one of the five rating codes, i.e., "G" for general audiences, "PG" for parental guidance, "PG-13" for suggested parental guidance, no one under 13 admitted without an adult, "R" for restricted and "X" for x-rated. As with the Parental Guidance category, by selecting a particular rating --by using the left or right direction arrow keys until the particular rating code appears in the active window--and then depressing the ENTER key, the user sets a key lock access for the rating, in which case a key icon appears below the rating code. And, as with the Parental Guidance category, once a key lock access is set, the system will prompt the user to enter the four digit key lock access code anytime a request is made to tune to, order or display schedule information for a particular program having a rating code which matches a rating code for which key lock access has been activated.

[0096] The Key Lock Access mode also includes a subject category 303 for controlling access to channels, which may be entitled, for example, "Channel Block" or "Channel Lock." As with the Parental Guidance 301 and MPAA 308 categories, the user navigates to the Channel Block category 303 by manipulating the cursor using the direction arrow keys on the remote controller and depressing the ENTER key. Once the Channel Block category 303 has been entered, the user can move horizontally to an active window 307, which in Fig. 30 indicates channel 2. Once the user highlights this window by manipulating the cursor using the direction arrow keys on the remote controller 40, a key lock access can be set for the channel appearing in the active window. This is done, as with the other subject categories in the Key Lock Access mode, by depressing the ENTER key, which again causes a key icon to appear below the channel number in the active window. The user can move to the prior channel or to the next channel in sequence by depressing either the left or right direction arrow key on the remote controller 40. In this manner, the user can activate a key lock access for any available channel.

[0097] As with the Parental Guidance 301 and MPAA 308 categories, once a key lock access is set for a particular channel, the system will prompt the user to input the key lock access code prior to carrying out an instruc-

tion to tune to or order that channel. If the input key lock access code matches the previously stored access code, the user's instruction is carried out. Otherwise, the user's instruction is ignored. Thus, the user can control access to the audio and video program content of any available channel. In this instance, the microcontroller 16 will not allow audio or video program signals to pass to the VDG, but it will allow schedule information to appear for the channel.

[0098] An alternative method for effecting lockout of programs is accomplished using a "Lockout" screen, as shown in Fig. 39. In addition to limiting access to programs based on the Parental Guidance, MPAA and channel criteria, as discussed above, access may be limited on the basis of program title. Fig. 39 shows an alternative Lockout screen 250 that can be used to permit or limit access to programs based on program title, in addition to the aforementioned criteria. Other parameters also may be included, such as time of day, day of week, credit limit, and content category (e.g., talk shows).

[0099] To enter the Lockout screen 250 shown in Fig. 39, the user must enter a multi-digit lockout code using the numeric digit keys 42 and the enter key 44 on the remote controller 40. The lockout code is set initially when the system is first used or installed. To set a lockout code in the first instance, the user accesses a Setup screen 260, such as that shown in Fig. 40. The Setup screen 260 will automatically appear the first time the electronic program guide is installed and initialized. For access during normal operation of the electronic program guide, a suitable access path to the Setup screen 260 may be provided, such as from an appropriate icon in the MAIN MENU 215.

[0100] In the Setup screen 260 of Fig. 40, the user can navigate to the Lockout Code category 265 and set a new lockout code using the appropriate navigation and selection keys on the remote controller 40. A suitable menu for inputting the lockout code is shown in Fig. 40A. Once enabled, the lockout code must be used to set or modify locks, to view a previously locked program, or to clear or change the lockout code. The memory location of the stored lockout code also should be remotely accessible, such as by the local cable company, in case the user forgets the lockout code and it must be erased.

[0101] Once the lockout code is entered and the Lockout screen 250 of Fig. 39 is displayed, navigation within the screen is controlled by the direction keys 43A and 43B on the remote controller 40. Using the up and down direction keys 43A to move the selection cursor, either the Movie Rating 251, Parental Guidance 252, Channel 253, Locked Program 254 or Lockout Code 255 category can be selected. The left and right direction keys 43B are then used to navigate inside the selected category.

[0102] Clearing a previously set lockout code is accomplished by moving the selection cursor to the "clear" entry 256 in the Lockout Code category 255 and depressing the enter key 44 on the remote controller 40. This causes the microcontroller to clear the lockout code

stored in memory, as well as all locks previously set by the user. To change the current lockout code, the user navigates to the "Change" entry 257 in the Lockout Code category 255 and depresses the enter key 44 on the remote controller 40. The user is then prompted to enter a new lockout code, which is subsequently stored in memory by the microcontroller.

[0103] To set a lock in either the Movie Rating 251 or Parental Guidance 252 category, the user navigates to the selected entry in Fig. 39 by manipulating the selection cursor using the direction keys 43A and 43B on the remote controller 40, and then depresses a lockout key on the remote controller, such as the padlock key 45A shown in Fig. 4. The microcontroller will appropriately modify the display to indicate that a lock has been set, for example, by changing the color of the text or the background in the selected entry window, or by displaying an appropriate icon next to the text in the selected entry window. In Fig. 39, a padlock icon 258 appears in the window of the "PG" entry in the Movie Rating category 251. Toggling the lockout key while the selection cursor is positioned on a selected entry will alternately enable and disable the lockout function for that entry.

[0104] Similarly, to set a lock for a particular channel, the user selects the channel using the selection cursor and then depresses the lockout key. In Fig. 39, the channel "4 KCNC" entry in the Channel category 253 has been locked, which is indicated by the inverse video and padlock icon appearing in the window.

[0105] Program locks also may be set by title, which can be effected in several ways. For example, when the above-described FLIP or BROWSE mode of the electronic program guide is enabled, thereby causing the title of a program to be displayed along with other program schedule information in a window superimposed on the actual program signal then being received, the user can limit access to the program corresponding to the displayed program information by depressing the lockout key 45A on the remote controller 40. The user also may limit access to the currently tuned program by depressing the lockout key 45A on the remote controller 40 while viewing the program, regardless whether the FLIP or BROWSE modes are enabled. In this instance, the microcontroller first removes the program signal from the display and then accesses the schedule information database record for the program then appearing and sets an appropriate flag to indicate the program has been locked. Also, when viewing program schedule information in the grid or category listings, as discussed above and shown, for example, in Figs. 18-20, the user also can tag a program for lockout by highlighting it with the selection cursor and then depressing the lockout key 45A on the remote controller 40.

[0106] In each of these instances, the microcontroller then stores the program title in a lockout title list stored in memory along with any other titles that previously have been locked out by the user. Individual items in the lockout title list are displayed in alphabetical order in the

"Locked Program" window 259 shown in Fig. 39, and the user may scroll through the list by positioning the selection cursor on the Locked Program window 259 using the up and down direction keys 43A on the remote controller in Fig. 40 and then using the left and right direction keys 43B to scroll through the list one item at a time. In order to save memory space, alternatively, the microcontroller may be programmed to set a flag or otherwise mark the particular database record containing the program schedule information for the program that is to be locked out, and to thereafter access the database to retrieve the title information when it is to be displayed, such as when the viewer is reviewing the lockout title list in the Locked Program window 259.

[0107] Once an individual title has been locked out, the microcontroller can be programmed optionally to display an appropriate lockout icon, such as a padlock, whenever program schedule information for the locked program is to be displayed, such as in the window overlay of the FLIP or BROWSE mode, or in the various grid and category displays available in the MAIN MENU displays. The system also may display an appropriate text message if someone tries to access the program signal of a previously-locked program. Of course, once a program is locked, in all instances the microcontroller prevents access to the actual program signal (including both the audio and video portions of the program signal) until an appropriate code is entered or the lockout is removed.

[0108] Several methods can be used to block programs at their time of airing. For example, in the case of the Movie Rating, Parental Guidance and Channel categories, the schedule information database record for each program is provided with a field that corresponds to the rating, program content identifier or channel appearing, respectively, in the Movie Rating 251, Parental Guidance 256 and Channel 253 category of the Lockout screen 250 shown in Fig. 39.

[0109] During operation, the microcontroller checks the appropriate field in the database record in response to a user command to tune to or order a program before carrying out the tuning or ordering function. Additionally, the lockout code also may be used to restrict access to program schedule information. In this instance, the microcontroller also would check the appropriate field in the schedule information database record before displaying schedule information for a program.

[0110] If the movie rating, parental guidance or channel identifier in the program schedule information database record matches any one of the locked-out entries indicated in the Lockout screen 250, a Lockout Verify screen 300 is displayed in overlaying relationship with the video signal then being displayed on the television receiver, as shown in Fig. 41. The user will be prompted to enter the previously set lockout code before the system takes any further action. As an added security measure, asterisks will be displayed as the user enters the lockout code. If the entered code matches the lockout code previously entered and stored by the user as described

above, the system will carry out the user request to tune to or order the program, or to display its corresponding schedule information. If the code is not recognized by the system, no further action will be taken and the user's request will be denied. In this case, the Lockout Verify screen 300 will remain displayed on the television receiver waiting for a correct code to be entered. If no action is taken by the user, the Lockout Verify screen 300 will be removed after a predetermined time-out period, such as one or two minutes.

[0111] Similarly, in the case of lockout by title, the microcontroller also could check the title field in the schedule information database record and compare it with the list of program titles for which the user previously set a lock. If, as described above, the microcontroller does not maintain a list of the actual titles of programs locked by title, a suitable identifier can be set in a field in the database record to indicate that a program has been locked by title when the user first sets the lock, and, thereafter, the microcontroller could check that field in response to a user request to tune to or order a program, or display schedule information.

[0112] An alternative method for effecting lockout involves the use of a portion of the real-time program signal being received by the television receiver. With this method, codes corresponding to a program's rating, parental guidance category, title or channel are inserted into and transmitted along with the program signal, such as in the vertical or horizontal blanking intervals, or on raster scan lines that are not visible on the television receiver. When the program signal is received, these codes are stripped from the program signal and stored in memory. Methods and apparatus for the insertion transmission and reception of digital codes carried on a program signal are known in the art.

[0113] After the transmitted codes have been separated from the program signal and stored in memory, the microcontroller can compare them with the lockout criteria set by the user in the Lockout screen and take appropriate action, as described above.

[0114] The Setup screen 260 shown in Fig. 40 also contains a Purchase Code category 270, which allows the user to set a numeric purchase code that must be entered before any premium channels or pay-per-view programs can be ordered. The Setup screen 260 shown in Fig. 40 includes entries for setting a new purchase code and for clearing or changing a previously set password. Appropriate menus for setting, confirming, clearing or changing the purchase code are shown in Figs. 40B through 40E. Once a user sets a purchase code, the microcontroller thereafter will display a Purchase Code Verify screen in response to a user request to tune to or order a premium services channel or pay-per-view program. The Purchase Code Verify screen works in a manner similar to the Lockout Verify screen 300 in that the user is prompted to enter the previously set purchase code password before the microcontroller will tune to or order the requested program. If the correct purchase code is

not entered, the microcontroller will take no further action and the Purchase Code Verify screen will remain displayed waiting for input of the correct code. If no action is taken within a predetermined time-out period, the Purchase Code Verify screen will be removed.

[0115] The next option shown in Fig. 7 is the Channel Preference or "Favorite Channel" list option 71. By highlighting this icon and depressing the ENTER key on the remote controller 40, the user is presented with a submenu on the screen such as that shown in Fig. 8.

[0116] In normal operation, the program guide system presents channels to the user in numerical order in response to an up or down change-channel command issued by the user using one of the direction arrow keys on the remote controller. The channel number presentation sequence includes all channels offered by the cable company in the order of which they are modulated onto the channel by the operator.

[0117] The program guide system also provides the capability of selecting from among several user-defined channel presentation sequences, which are activated using one of the three "check mark" icon keys 48A, 48B or 48C on the remote controller 40 shown in Fig. 4. Each of these keys represents a preferred particular list of channels which a particular user selects and which the microcontroller stores in memory as a "Channel Preference" list, as discussed in detail below. To activate one of these preferred channel lists, the user depresses the corresponding check-mark icon key, in which case the microcontroller may display the chosen icon on the screen in the graphic overlays and full screen displays to remind the user that a particular channel preference list is being used by the system. Once a preference list is activated, the system will limit the tuning of the television receiver and the display of schedule information only to those channels that are designated in the activated viewer preference list.

[0118] To revise the content and/or sequential order of the channels in the Channel Preference list, the user enters the MENU mode of the programming guide system. To enter the MENU mode from the FLIP mode, the user twice depresses the MODE key 38 when using the remote controller 31 of Fig. 3. To enter the MENU mode when using the alternative embodiment of the remote controller 40 of Fig. 4, the user simply depresses the MENU icon key 47B.

[0119] When first entered, the MENU mode has a screen display such as shown in Fig. 6. To select the submenu for editing the Channel Preference list, the user first selects the third horizontal bar 63, which can be titled, for example, "Messages" or "Customer Service," by manipulating the cursor using the down direction arrow key, as shown in Fig. 7. The screen of Fig. 6A is thereby displayed. The user then selects the second icon 161 appearing in that bar, indicated with a check mark, which corresponds to a "Viewer Preference" mode, by highlighting the icon using the direction arrow keys and again depressing the ENTER key. This action will cause the

microcontroller 16 to display a Viewer Preference sub-menu such as that shown in Fig. 7. By selecting the Channel Preference or "Favorite Channel" entry 71, the user enters the Channel Preference submenu, shown in Fig. 8. If the user has not already done so, he would then depress the particular check-mark icon key on the remote controller 40 of Fig. 4 to create or revise the particular channel preference list.

[0120] In the Channel Preference menu shown in Fig. 8, a list 80 of all channels available on the particular cable system is displayed on the left side of the television receiver screen, labeled "Choices" in Fig. 8, and the viewer's preferred list 81, designated "Selected" in Fig. 8, is displayed on the right side. If a particular code, such as an END or "-1" symbol appears in the first (uppermost) position 82 of the viewer preference list 81, the system displays information for all channels in numerical order in all modes of operation. This is the default mode of the system.

[0121] By selecting channels in sequence from the available list 80 and placing them in the desired order in the preference list 81, the user can select a subset of channels and/or rearrange the default sequence in response to a channel up or channel down command from the user. This is accomplished by highlighting a channel in the available list 80 using the up and down direction arrow keys on the remote controller 40 and depressing the ENTER key 44, which stores the entry temporarily in a buffer.

[0122] The microcontroller 16 stores a list of all channels previously entered in the viewer preference list 81. As a particular channel is highlighted by the user when navigating through the available channel list 80 displayed on the left side of the television screen, a window 84 appears adjacent to the particular channel highlighted by the user. If the particular channel already appears in the viewer preference list 81, the system displays a "DELETE" message in the window 84 as a reminder that the channel was previously selected from the available channel list 80 and can only be deleted from the list 81, which is accomplished by depressing the ENTER key 44. If the particular highlighted channel in the list 80 was not previously selected, the system displays a "SELECT" message in the window 84 as a reminder that the particular channel will be selected for addition to the viewer preference list 81 if the user depresses the ENTER key 44. The microcontroller 16 inserts a selected channel at the bottom of the list 81. In this manner, the user can select or delete channels from the viewer preference list in any desired order.

[0123] The available channel list 80 may also be provided with categorical entries 83, such as movies, news, sports or children's shows. The user may also highlight any of these entries and put them into the viewer preference list 81. If the user does include a category in his viewer preference list 81, when the user issues channel up or down commands, the system will display, in sequence, first the user's selected preferred channels in

numerical order and then all channels having a program whose content corresponds to the selected category or categories at the time.

[0124] Once the user has revised the channel preference list 81 in the described manner, the microcontroller 16 will follow the stored user-specified channel sequence in response to a change-channel command made by the user employing one of the direction arrow keys. To activate the viewer preference list, the user depresses one of the three check-mark icon keys 48A, 48B or 48C on the top of the remote controller shown in Fig. 4. The viewer preference list can be used to selectively limit tuning of the television receiver or display of schedule information in any of the operating modes of the electronic program guide. In the present embodiment, once a preference list is activated, the system will limit the tuning of the television receiver and the display of schedule information in the FLIP, and BROWSE modes, as well as in the grid category and channel listings in the MENU mode, only to those channels designated in the activated viewer preference list. The tuner can not be tuned to, and no corresponding schedule information can be displayed for, any channel not entered in the viewer preference list when it is activated. In this regard, it should be noted that setting a key lock access in the Parental Guidance 301, MPAA 308 or Channel Block 303 categories produces a different result than when using other display criteria, such as the Channel Preference List of preferred channels discussed above. Thus, while a key lock access will prevent audio and video program information, but not schedule information, from being displayed or ordered absent entry of an authorization code, if a particular channel is included in the Channel Preference list and also has a key lock access activated in the Channel Block category 303 of the Key Lock Access mode, that channel or its corresponding schedule information will not be displayed at any time.

[0125] To deactivate a previously selected viewer preference list, the user toggles the appropriate check-mark icon key on the remote controller 40 of Fig. 4. Once deactivated, the system defaults to displaying and tuning all available channels, as well as displaying schedule information for all available channels.

[0126] Alternatively, the viewer preference list 81, if activated, can be used to control tuning and display of schedule information only in selected modes, such as only in the FLIP mode, thus allowing the user to tune and view corresponding schedule information only for those channels entered in the preference list 81 in the FLIP mode, while viewing all channels and corresponding schedule information in all other modes.

[0127] In this latter configuration, as well as in the instance where no channel preference list is activated and the system is in default mode, if a channel appears in the viewer preference list 81 that corresponds to a service not subscribed to by the user, the microcontroller 16 causes an ordering submenu to appear instead of displaying a program signal along with the graphic overlay,

as shown in Fig. 9. This submenu indicates to the user that he does not currently subscribe to the selected service, and then asks the user if he would like to order the service. If the user responds affirmatively, the program schedule system takes the user to another ordering submenu to confirm the user's request, as with impulse ordering.

[0128] The program guide also may be configured with a Locator screen 201, as shown in Fig. 37, which aids the viewer in channel selection and definition of a favorite channel list. The Locator screen 201 displays all available channel numbers grouped according to the source of the program information appearing on any particular channel at any particular time, e.g., broadcast, cablecast, pay-per-view, near video on demand, satellite, or other source of program material. Thus, the Locator screen 101 can be used to locate any particular channel or service because the groupings provide a quick and efficient method for scrolling through the list of available channels. The channel numbers also may be grouped according to other criteria, such as program category, program content, program rating or other content-based standard, time of availability, numerical order, or other logical grouping.

[0129] In the example shown in Fig. 37, the user navigates within the Locator screen 201 using the direction keys 43A and 43B on the remote controller 40. The right and left direction keys 43B move the selection cursor within the category rows, while the up and down direction keys 43A are used to select a particular category. From the Locator screen 201, any particular channel can be selected for viewing by positioning the selection cursor on the desired channel and depressing either the enter key 44 or an optional tune key (not shown) on the remote controller 40.

[0130] In addition to aiding in channel selection, the Locator screen 201 also provides the user with the ability to conveniently define favorite channel lists. To do so, the user first moves the selection cursor to the desired channel by using the direction keys 43A and 43B or numeric digit keys 42 on the remote controller 40, and then depresses a favorite channel key 46A provided on the remote controller 40, which causes the display to change in some manner or characteristic as an indication that the channel has been selected as a favorite channel, such as by changing the color of the channel identification text or the text background, by displaying an appropriate icon or by some other appropriate identification scheme. In the remote controller 40 shown in Fig. 4, the pound key "#" can function as the favorite channel key.

[0131] Also, if multiple favorite channel lists are being used, the user would depress the appropriate favorite channel key on the remote controller to select a particular list before depressing the favorite channel key. For example, as discussed above, the remote controller 40 shown in Fig. 4, has three color-coded check-mark favorite channel keys 48A, 48B and 48C, which provide for at least three individual favorite channel lists for three individual users. Different identification characteristics

could be displayed on the Locator screen 201 to indicate that a particular favorite channel list is selected. For example, the icon or image used to enable a favorite channel list on the remote controller, such as the check mark key 48A used on the remote controller 40 shown in Fig. 4, could be displayed on the Locator screen 201, as well as other screens of the program guide, when a favorite channel list is enabled. Alternatively, the color of the displayed text or background could be changed to match the color of the selected favorite channel key.

[0132] The Locator screen 201 may be accessed via several paths. For example, it may be included as a virtual channel that is conveniently positioned in the channel-tuning sequence, such as between the highest and lowest available channel numbers -- for example, a virtual channel 0. To the user, such a virtual channel appears to be a conventional channel. However, it requires no additional bandwidth as a carrier. For example, it can be digitally produced at the subscriber station or included in an appropriate blanking interval in existing bandwidth frequencies. In this manner, the virtual channel is accessible either by entering the corresponding channel number using the numeric digit keys 42 on the remote controller, or by using the up and down direction keys 43A to wrap around from the highest to the lowest channel number, or vice versa. As shown in Fig. 38, it also may be desirable to provide a suitable identifier, such as an icon or text message 210, in the MAIN MENU display 215, from which the user could access the Locator screen 201 simply by highlighting the identifier 210 with the selection cursor and depressing the enter key 44 on the remote controller 40. Alternatively, the remote controller may be provided with a key corresponding to the Locator screen 201 which would cause the microcontroller to display the Locator screen 201 when the user depressed it.

[0133] In addition to Channel Preference or Favorite Channel keys, the remote controller 40 can also be supplied with a number of user-activated category preference icon keys, e.g., movies, sports, or children's programming. The system can be adapted to present to the user only those programs meeting particular preference category when it is activated by the user. As with the Channel Preference icons, the microcontroller may display the icon corresponding to the activated preference category to remind the user of the currently activated mode of system operation.

[0134] The question mark icon 162 at the far right of the third horizontal bar in the menu of Fig. 16 identifies a program guide system "Help" mode in which information explaining the operation of the system is displayed for the user. Again, by manipulating the cursor using the appropriate keys on the remote controller, the user can select this mode. Once selected, the next submenu appearing in the Help mode asks the user to identify the particular portion of the system about which the user would like to view Help information.

[0135] The icons appearing in the last horizontal bar of the MENU mode identify certain interactive and/or oth-

er types of information services which the programming system, acting as a gateway, makes available to the user as shown in Fig. 17. By manipulating the cursor, the user can select any one of the identified services, as shown in Figs. 31-35.

[0136] For example, if the user initially selects the "X*PRESS" icon appearing in the last horizontal bar, he is presented with a submenu such as that shown in Fig. 31. Using the direction arrow and enter keys on the remote controller, the user selects one of the three entries appearing in the display of Fig. 31. Once a particular entry is selected, the electronic program guide connects the user to the selected service and passes control to the particular service application software, as shown in Figs. 32-35.

[0137] Alternatively, the remote controller 40 can be supplied with a plurality of content-specific keys corresponding to a plurality of content-specific categories of programming, e.g., a Sports key, News key, Movie key, etc. When the user depresses a content-specific key, a content-specific mode is initiated. In Fig. 4, the remote controller is equipped with a Sports key 49. If the user depresses the Sports key 49, the microcontroller will limit the display of programs and/or program schedule information to those that are sports-related. The microcontroller will block all other programming or schedule information from appearing on the television receiver. The microcontroller can be adapted to distinguish programs and schedule information that are sports-related by examining an appropriate code associated with the program or schedule information.

[0138] As discussed above, coding can be accomplished using any number of methods, such as by including an appropriate code in the vertical blanking interval of the program signal, or in an appropriate memory location in the database record of the program schedule information, or if the schedule information is being received on a broadband network, by including it in an appropriate blanking interval. The user activates a content-specific mode by depressing the appropriate content-specific key in any mode of operation of the electronic programming guide, including the aforescribed FLIP, BROWSE or MAIN MENU modes, as well as when no schedule information is being displayed and only a program signal is visible on the television receiver. Once a content-specific mode is requested by the user, the microcontroller immediately and directly enables the content-specific programming criteria, and maintains it for all operating modes of the guide until disabled, which can be accomplished, for example, by toggling the Sports key 49.

[0139] Instead of a dedicated content-specific key, such as Sports key 49, the system may be configured with a single, generic content-specific key, which, when activated, would cause the microcontroller to display a content-specific menu containing a list of all content-specific categories available to the user. The user then could highlight a particular category by manipulating the selection cursor using the direction arrow keys on the remote

controller and select it by depressing the ENTER or OK key 44. As an alternative to using a content-specific key on the remote controller, access to the content-specific menu can be effected by providing an appropriate identifier in another menu screen of the electronic guide, such as in the LOCATOR, SETUP or MAIN MENU screens.

[0140] In addition to blocking all non-selected content-specific programming when a particular content-specific category has been selected, the microcontroller can be programmed to enable all added-value programming or services that are specially related to the selected content-specific category. For example, if the user activates a Sports content-specific mode, the microcontroller, in addition to allowing only sports programming or schedule information related to sports programming to be displayed, will proactively seek out and enable all sports related added-value services, such as related trivia or video games, up-to-date scores while a game is in progress, team schedules, replays of prior games of the selected teams or players, ticket or souvenir purchasing, etc. Thus, the information available from the programming or service can be integrated into the environment of the electronic program guide. Rather than simply passing control to another service as described above, in this manner the electronic program guide would function as a system integrator or interface to combine the available added-value information into a package within the electronic guide environment, thus essentially creating a series of modular electronic program applications corresponding to a variety of available content-specific categories.

[0141] The Setup screen shown in Fig. 40 also includes a Text Location category 275, which contains the textual entries "Bottom of Screen" and "Top of Screen." By navigating to the Text Location category 275 using the up and down direction keys 43A on the remote controller 40, and to either the "Top" or "Bottom" entries in that category using the left and right direction keys 43B on the remote controller, and then depressing the enter or select key 44, the user can control the position of the overlay windows used to display information in various operating modes of the electronic program guide. The Setup screen of Fig. 40 provides the user with two positional choices: the top or bottom of the screen. Depending on the modes of operation of the program guide, it may be desirable to provide the user with more positional choices in viewing area of the television receiver, or to provide the user with the ability to choose a different position for information displayed different operating modes.

[0142] One of the novel features of the disclosed invention is the textfit system. The preferred embodiment of the text fit system includes an interactive computer program used to edit the program listings data before it is transmitted to the user and stored in memory. The interactive system operates as follows: unedited (or partially edited) program listings information is loaded into data a processor. The data includes program titles, pro-

gram schedule times, duration, category, as well as additional descriptive information dependent on the type of program. For example, for movies the data includes the MPAA rating, year of the movie, whether it is in black and white, and a list of starring actors and actresses.

[0143] The data processor extracts only the program title data which includes television program titles as well as movie titles, sporting events and titles for other special events. Based on the duration of the program, the data processor first analyzes the listings data to determine what grid size listings are needed for each title. Thus, a two hour movie could require four different edited titles to fit into each of the four different size grid cells (30, 60, 90, 120 minutes). The data processor then determines how much space is required to display the title based on its character length. If the title is to be displayed in the program schedule grid using a proportional font and character to character kerning, the data processor may also account for these factors in determining the space required to display a title. The determination would than be based on the number of pixels required for the particular combination of characters in the title. The amount of space available for display of a title depends on the size of the grid cell and the space required for display of icons, when activated.

[0144] If the data processor determines that a full title requires too much space to fit into one or more grid cells, the title is then presented to the editor using a suitable display device connected to the data processor, such as a CRT. The editor is then queried to alter the title so that it will fit in the allotted space. If the title must be edited for more than one cell size, the editor is queried to edit each of these separately. In the preferred embodiment of the interactive program, the editor is shown in real time whether the edited title will fit in the designated grid cell.

[0145] In the preferred embodiment, two lines of text are displayed in each grid cell of the program listings. The title, as edited, appears on the first line, and if necessary, continues onto the second line. The decision to wrap-around to the second line is based on whether natural breaks exist in the title such as spaces between words, commas, periods, hyphens, etc. These are standard techniques used in word processing software routines. The editor may also be queried to edit a title in the situation where the full title will fit on the allotted two lines, but a hyphen is required because there are no natural breaks in the title.

[0146] Prior to querying the editor to shorten a title, the data processor compares the title with a stored library of shortened titles to determine if the title had previously been shortened while editing another listings database. Each time changes are made by the editor to a title, the shortened title is added to the library. It is apparent that this process of building a library of shortened titles greatly reduces the manual input required.

[0147] A flow chart illustrating the process by which the text fit system operates is shown in Fig. 42. The chart illustrates the operation of editing a listing for display in

a program grid for a single platform, but operation is the same for all platforms.

[0148] Text editing may be necessary in other situations besides that where multiple size grid cells are used for display of the same title. For example, the disclosed program guide may run on several different platforms, with each one having different constraints and grid cell space availability. Some may not display the text in proportional fonts and some may have other limitations reducing the available space. Thus, in the preferred embodiment the interactive program would request edits for all platforms for which they required at the same time. In addition, editing of text may be required for display modes other than a grid of program listings. For example, in the "Listings by Channel" display of fig. 20, programs are listed on an entire, fixed-length line, but the length of the line may vary from platform to platform, so that the text fit system may be employed for the purpose of editing listings for the different platforms in this display mode as well. The space available for the display of text will also depend on how much space is reserved for icon display. The same process as that shown in fig. 42 would apply, except that there would be no need to determine what grid sizes are needed because a fixed length line is used for display rather than multiple sized grid cells.

[0149] It will be apparent to those of skill in the art that the disclosed text fit system has applications beyond that of title editing alone. The system may be easily modified to provide editing of messages, "i" screen storylines, pay-per-view promotional copy, and similar text messages so that they will fit into the designated space available for display of the text. In fact, the system may be used to edit any text for display in the disclosed program schedule system.

[0150] The computer program for the microcontroller 16 may also include a schedule for the display of varying background views upon which the program schedule information is overlaid either partially or in a full screen display. The background views may be stored as bit maps in memory or in another storage medium, such as an optical storage device. For example, the microcontroller 16 may be programmed to issue a command to the VDG every morning at 6:00 AM to display a sunrise in the background. The background may then be changed accordingly throughout the day to, for example, a blue sky or a nighttime view. It also may vary, e.g., by time of day, day of week, month, year or season. The mood background also could change depending on the particular category of programming that the user is watching or to which selected schedule information pertains. The mood background also may be adapted to display scenes that reflect the particular viewing area in which the user is situated, like the Rocky Mountains, or Mt. Rainier, etc. It also may be possible to display standard scenes, such as an ocean or forest scene. Moreover, the audio background also could be adjusted to relate to the particular mood background then being displayed. In addition, different background views may be used for holidays and special

events, such as Christmas, Fourth of July, Superbowl Sunday, etc. The purpose of the background views is to help ease the monotony of viewing program listings. The microcontroller 16 could be adapted automatically to coordinate the display of the mood background. The user also could be given the ability to choose from among various mood background displays by adapting the microcontroller to display an appropriate mood option menu that lists the mood background options available to the user and allows the user to select one or more by manipulating the selection cursor. Access to such a mood option menu could be achieved by supplying an appropriate identifier, textual or visual, in an appropriate menu of the system, such as the LOCATOR or SETUP screen.

[0151] Additionally, the electronic program guide could be configured to store a unique digital identifier for each program along with its schedule information and later use the identifier-- e.g., by transmitting it -- to indicate to a recording or storage device, such as a video recorder, that the user wishes to record the program. The program guide could also use the identifier to automatically control operation of the video recorder. The electronic program guide could also be configured to use other stored schedule information for this purpose.

[0152] The form and content of a particular computer program to implement the invention disclosed herein will be readily apparent to those skilled in the art of video system programming and graphic display. A flow chart showing the operation logic of the system is shown in Fig. 36. It will also be appreciated by those skilled in the art that there can be departure from the specific embodiment of the invention described herein without departing from the true scope of the claims appended hereto.

Claims

1. A method for using an electronic program guide to restrict access to program schedule information displayed on a television, the method comprising:

receiving and storing in memory television program schedule information;
 providing a user with the ability to set parental control options; and
 restricting the ability to view program schedule information on the television based on the parental control options, wherein restricted program schedule information is capable of being viewed when a code is received from the user.

2. A method according to claim 1, wherein restricting the ability to view program schedule information based on the parental control options comprises restricting the ability to view program schedule information based on at least one record field in a schedule information database.

3. A method according to claim 1, wherein restricting the ability to view program schedule information based on the parental control options comprises restricting the ability to view program schedule information based on at least one code transmitted with a program signal.

4. A method according to claim 1, further comprising restricting the ability to access television programming based on the parental control options.

5. A method according to claim 1, further comprising providing the user with the ability to activate the parental control options.

6. A method according to claim 1, further comprising providing the user with the ability to deactivate the parental control options.

7. A method according to claim 1, wherein providing the user with the ability to set parental control options comprises providing the user with the ability to indicate channels to which access is to be restricted.

8. A method according to claim 1, wherein providing the user with the ability to set parental control options comprises providing the user with the ability to indicate ratings of television programs to which access is to be restricted.

9. A method according to claim 1, wherein providing the user with the ability to set parental control options comprises providing the user with the ability to indicate television program titles to which access is to be restricted.

10. A method according to claim 1, further comprising unrestricting the ability to view the program schedule information that is restricted based on the parental control options by providing the user with the ability to submit a valid lockout code.

11. A system for using an electronic program guide to restrict access to program schedule information displayed on a television, the system comprising a receiver, a data processor, a user control apparatus, and a display generator, the data processor configured to:

receive and store in memory television program schedule information;
 provide a user with the ability to set parental control options; and
 restrict the ability to view program schedule information on the television based on the parental control options by directing the display generator not to display restricted program schedule information, wherein restricted program sched-

ule information is capable of being viewed when a code is received from the user control apparatus.

12. A system according to claim 11, wherein the data processor is further configured to restrict the ability to view program schedule information based on at least one record field in a schedule information database. 5
10
13. A system according to claim 11, wherein the data processor is further configured to restrict the ability to view program schedule information based on at least one code transmitted with a program signal. 15
14. A system according to claim 11, wherein the data processor is further configured to restrict the ability to access television programming based on the parental control options. 20
15. A system according to claim 11, wherein the data processor is further configured to provide the user with the ability to activate the parental control options using the user control apparatus. 25
16. A system according to claim 11, wherein the data processor is further configured to provide the user with the ability to deactivate the parental control options using the user control apparatus. 30
17. A system according to claim 11, wherein the data processor is further configured to provide the user with the ability to indicate channels to which access is to be restricted. 35
18. A system according to claim 11, wherein the data processor is further configured to provide the user with the ability to indicate ratings of television programs to which access is to be restricted. 40
19. A system according to claim 11, wherein the data processor is further configured to provide the user with the ability to indicate television program titles to which access is to be restricted. 45
20. A system according to claim 11, wherein the data processor is further configured to unrestrict the ability to view the program schedule information that is restricted based on the parental control options by providing the user with the ability to submit a valid lock-out code using the user control apparatus. 50

55

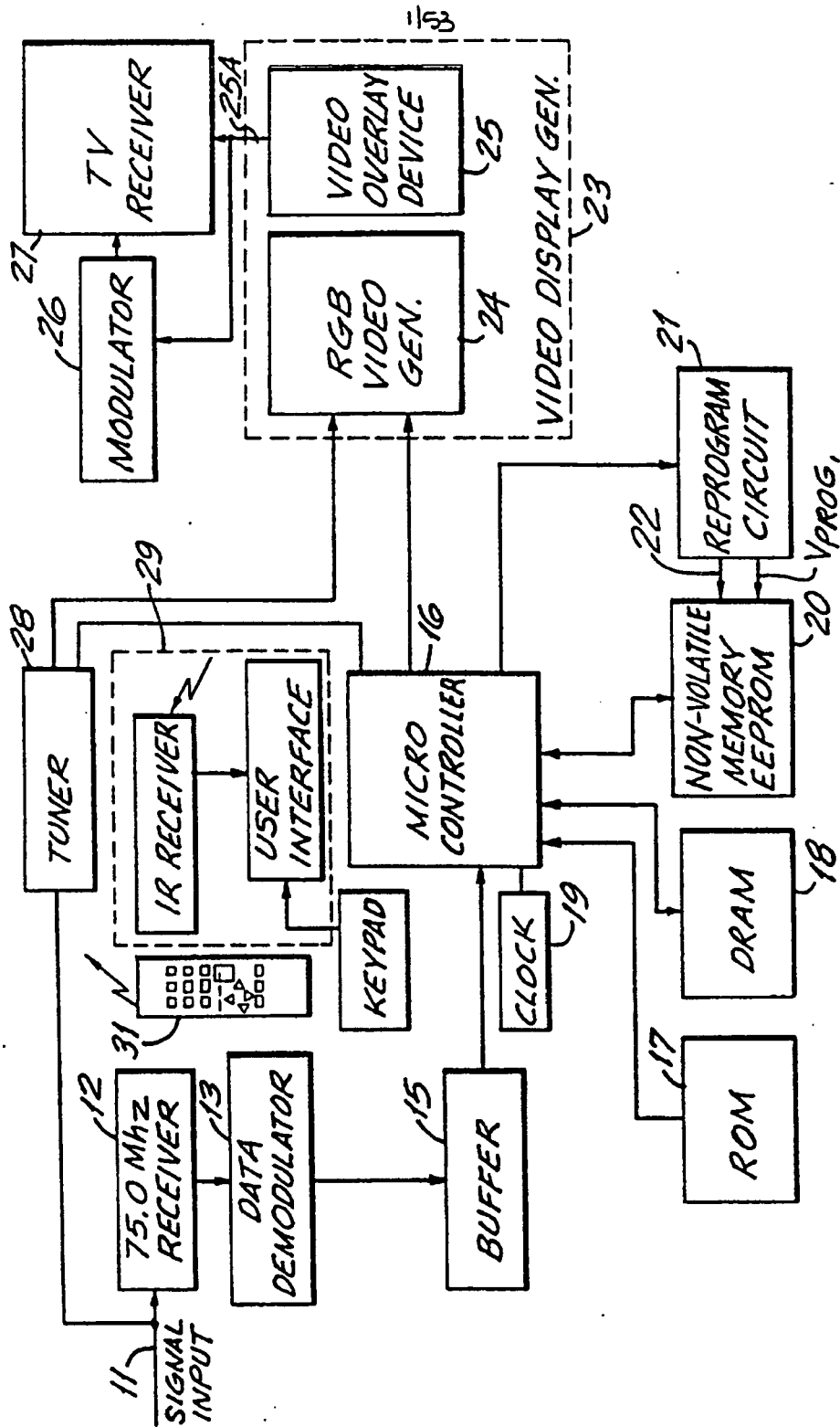

FIG. 1

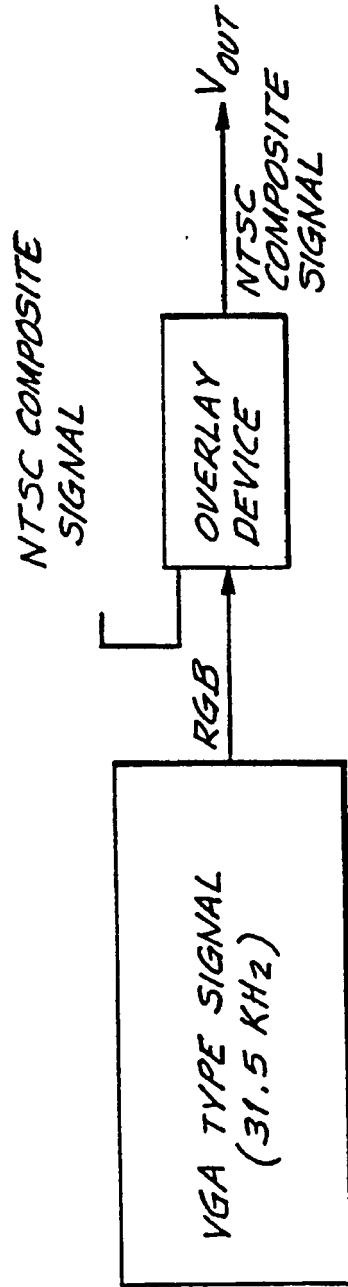
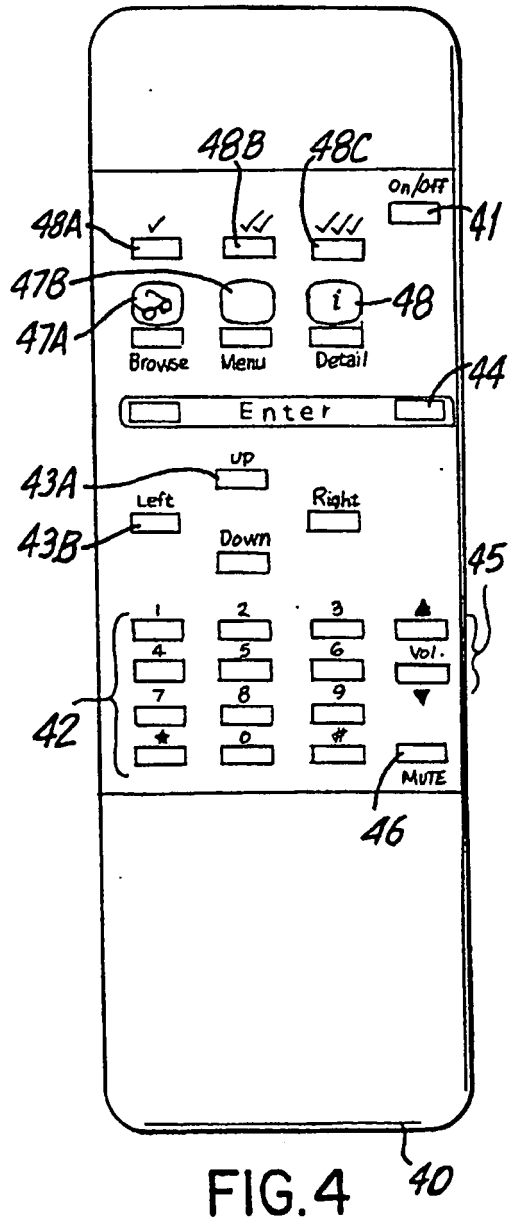
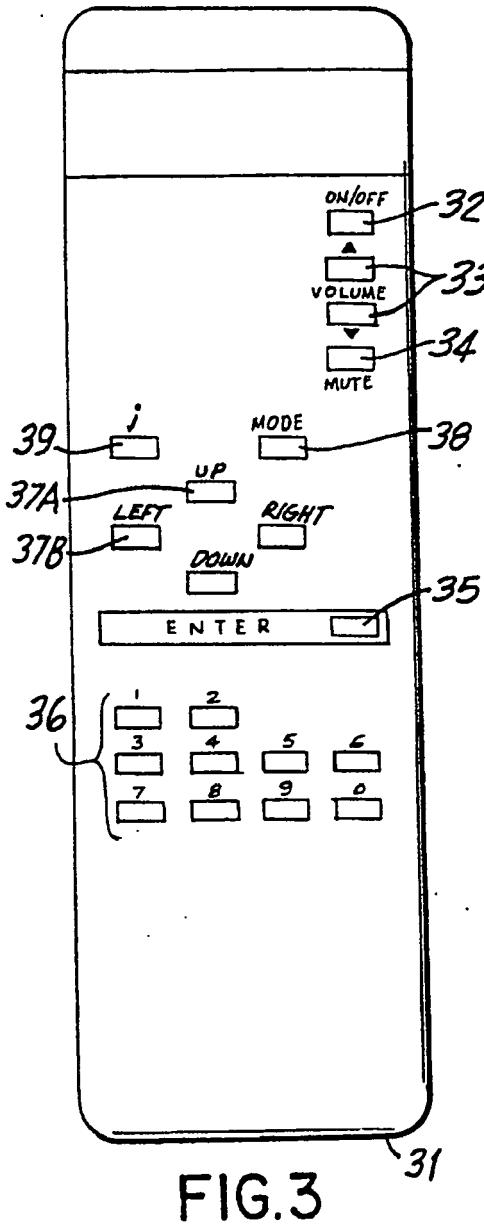

FIG. 2



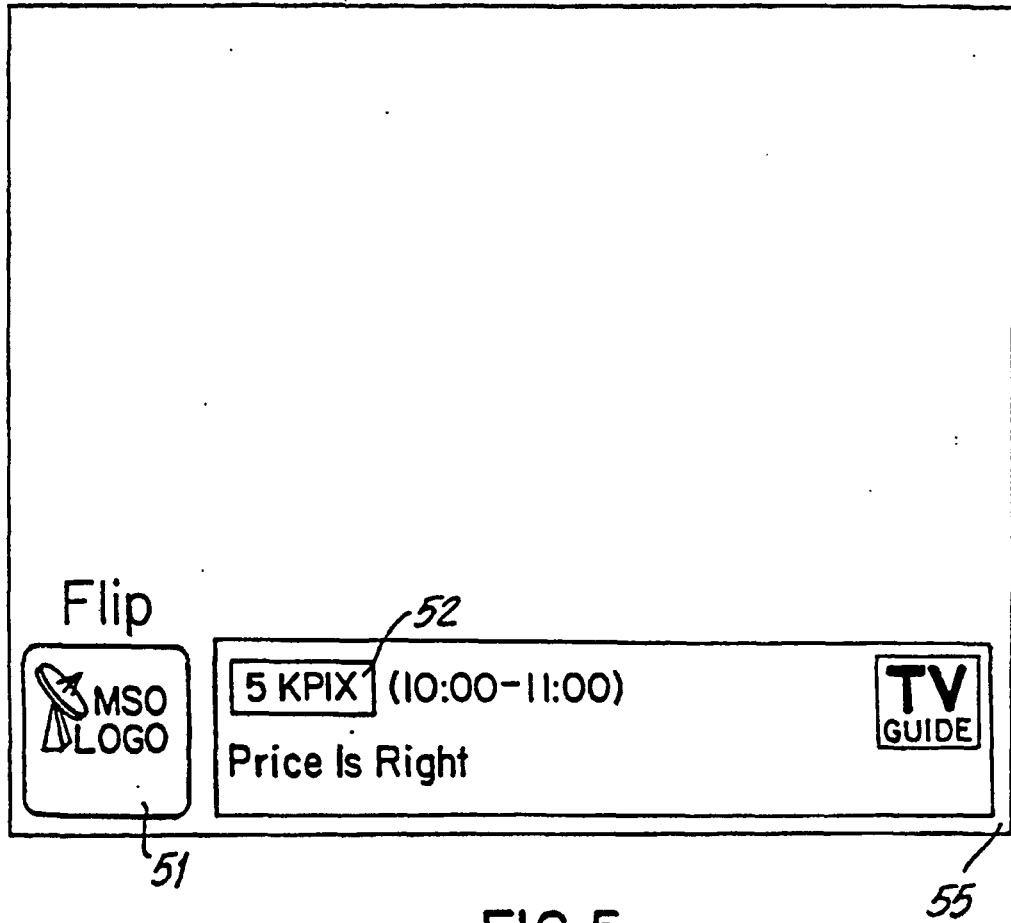

FIG. 5

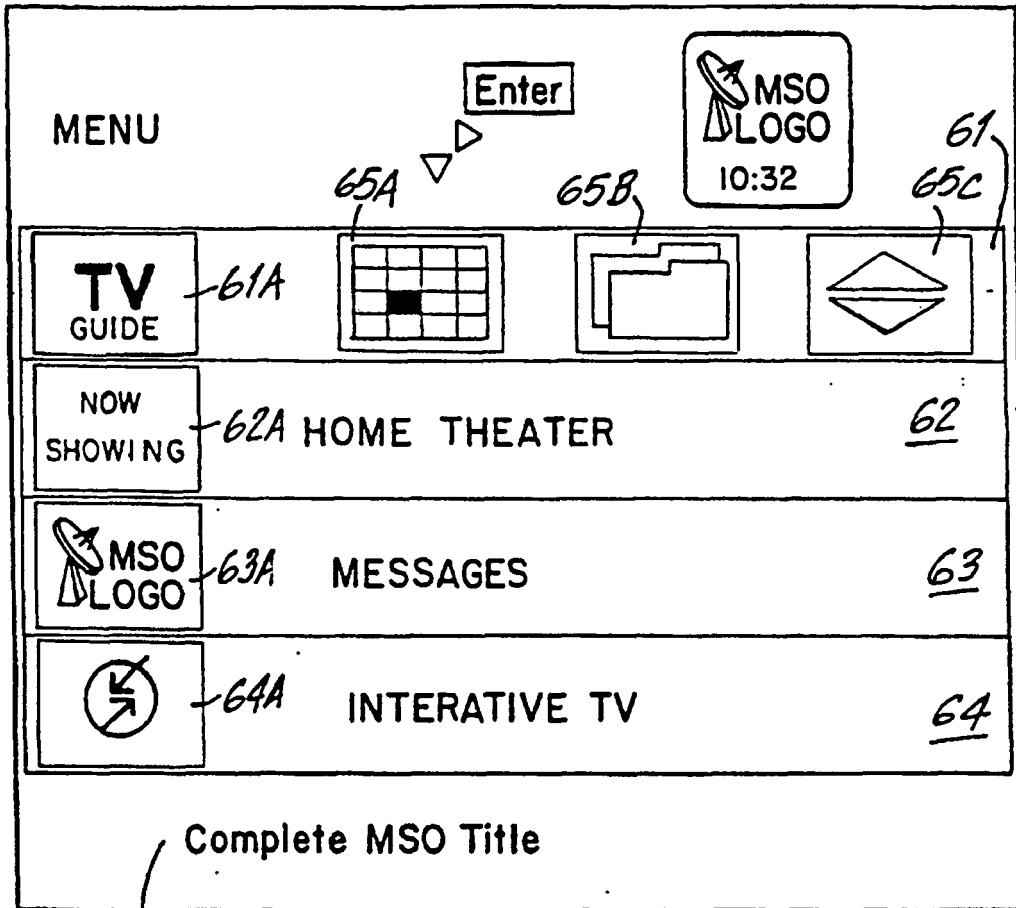

FIG.6

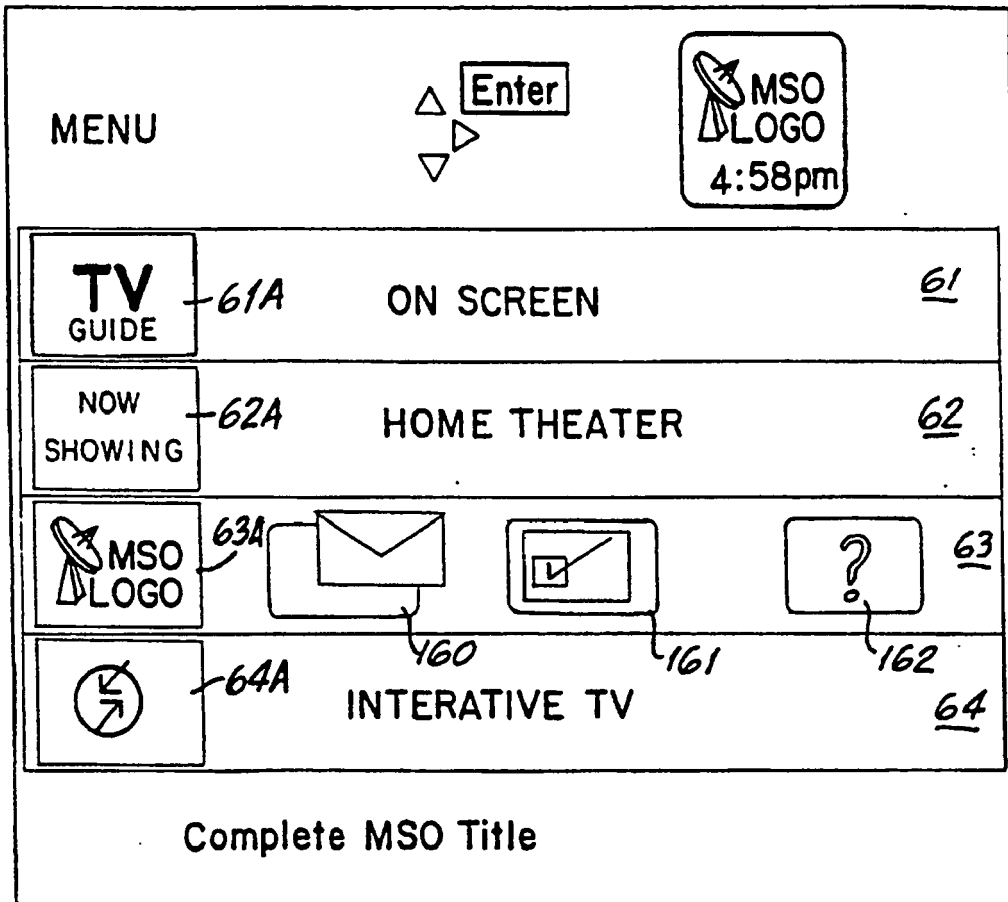

FIG.6A

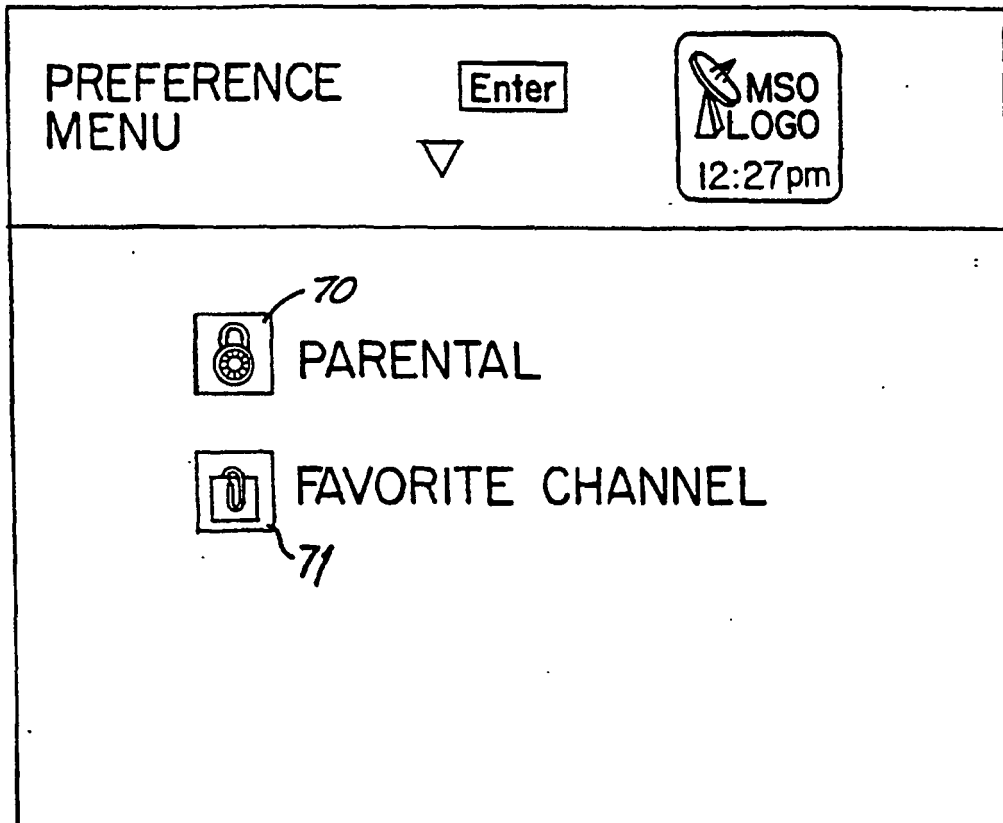

FIG.7

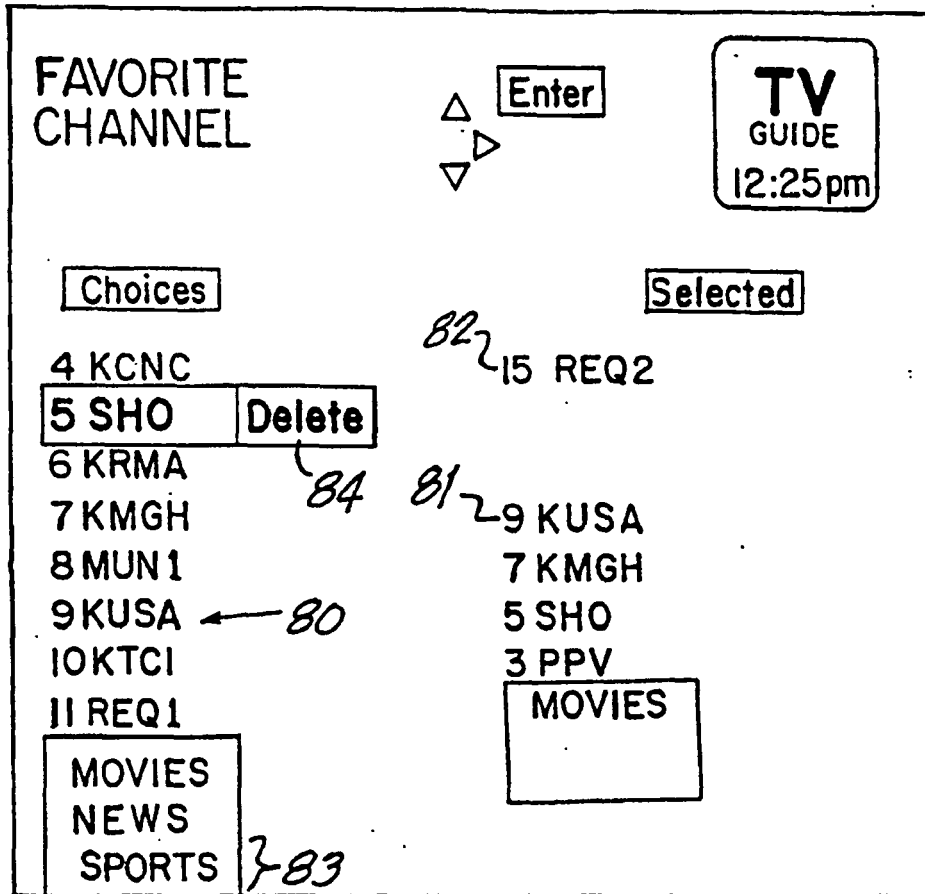

FIG.8

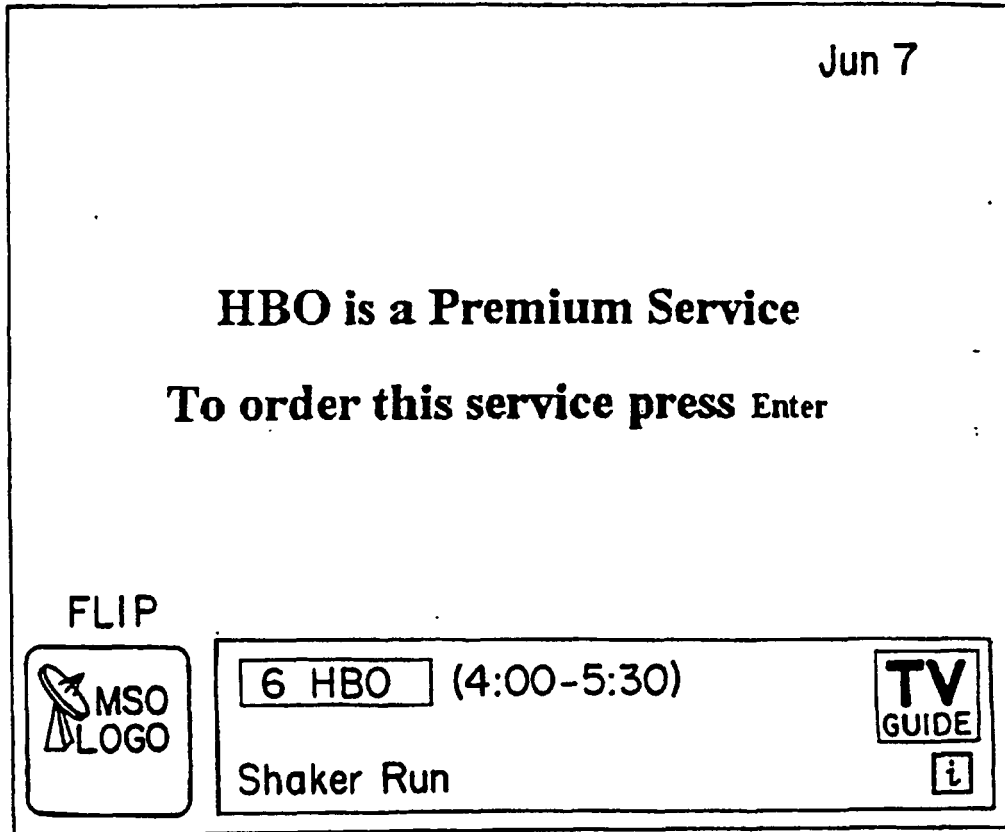

FIG.9

Premium Services	<input type="button" value="Enter"/>	
<input type="button" value="HBO"/>	Home Box Office \$10.40/Month	
<input type="button" value="SHO"/>	Showtime \$9.95/Month	
<input type="button" value="DIS"/>	The Disney Channel \$9.95/Month	
<input type="button" value="TMC"/>	The Movie Channel \$1.50/Month	
<input type="button" value="MAX"/>	Cinemax \$9.95/Month	
<input type="button" value="PLA"/>	Playboy at Night \$4.95/Evening(5:00pm to 3:00am)	
<input type="button" value="ACT"/>	Action \$5.95/Day(11:00pm to 3:00pm)	
Movie, special events, and family programming!		
You are not a Subscriber. Press <input type="button" value="Enter"/> to Subscribe!		

FIG. 10

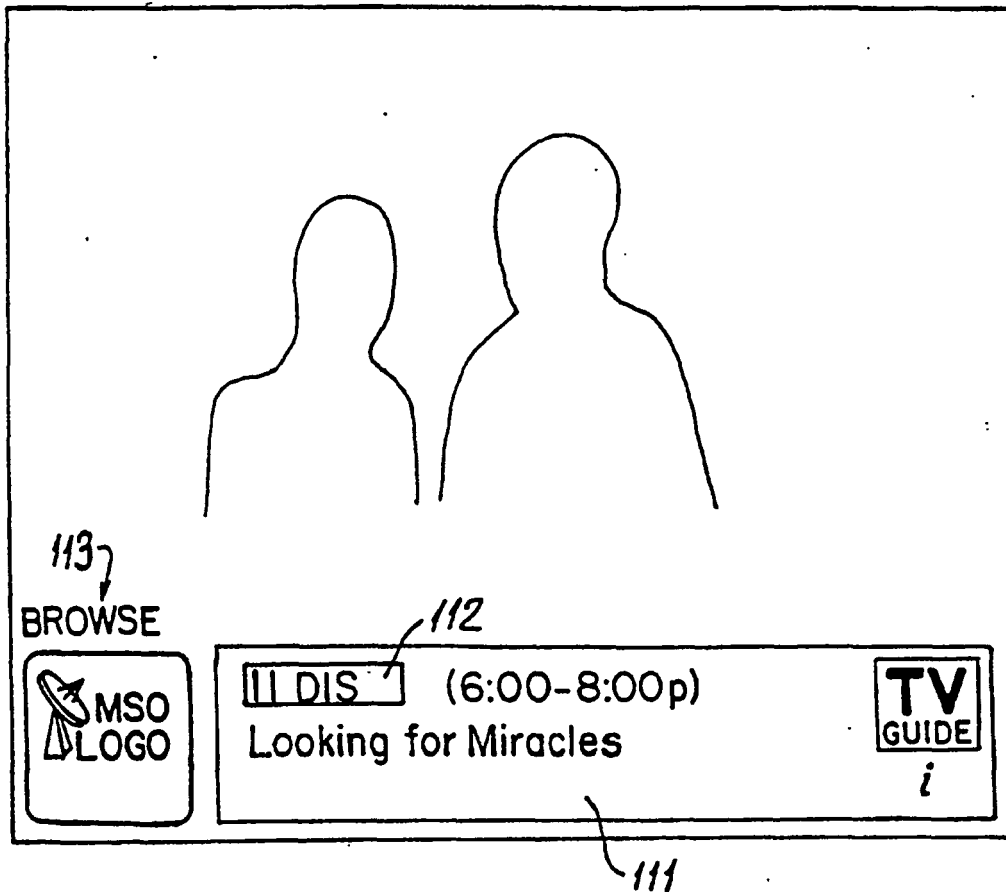

FIG. II

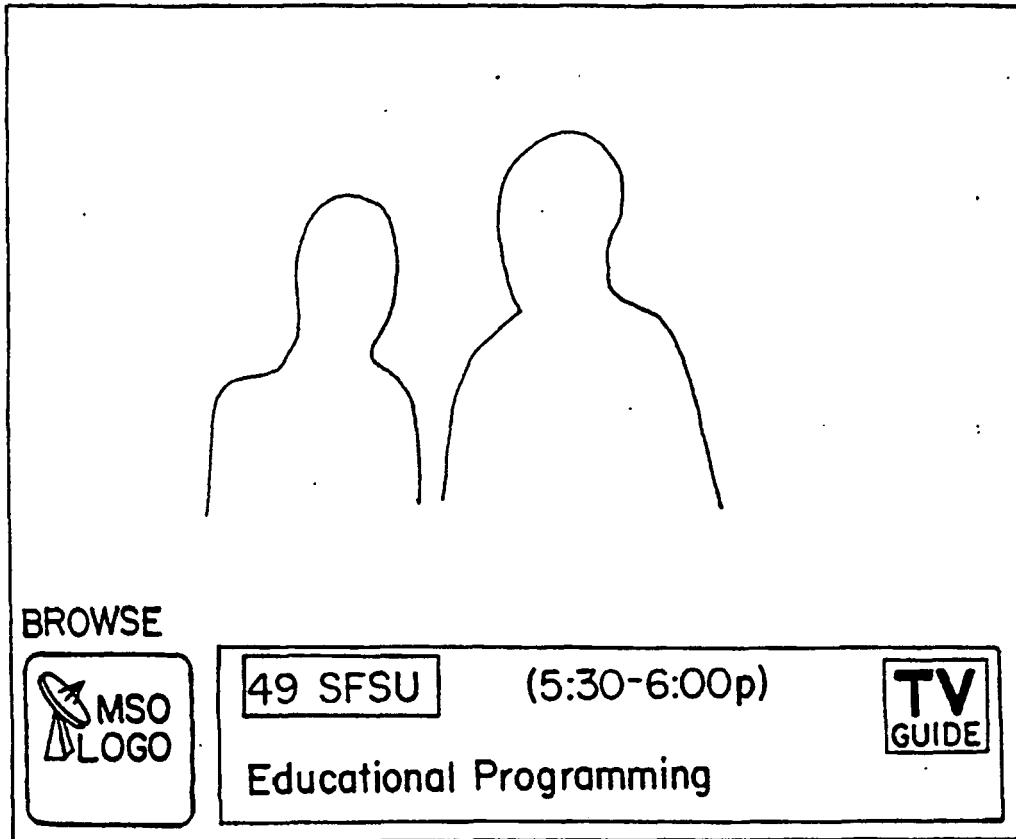

FIG.12

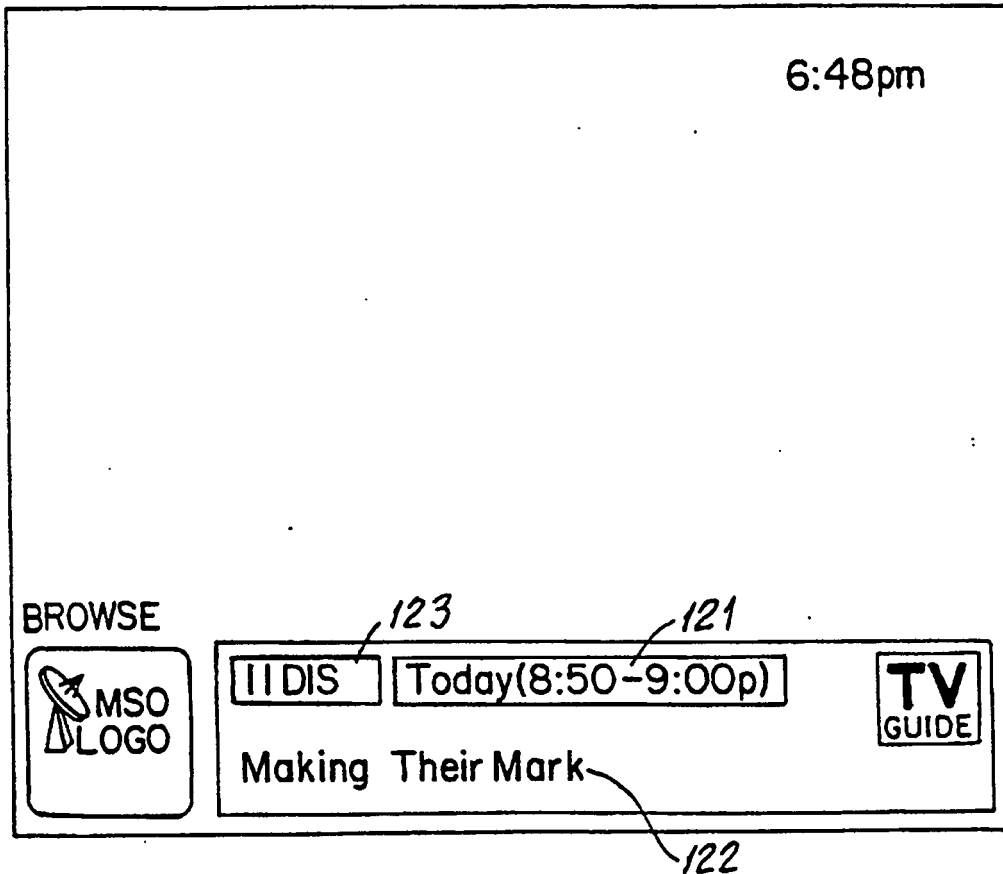

FIG. 12A

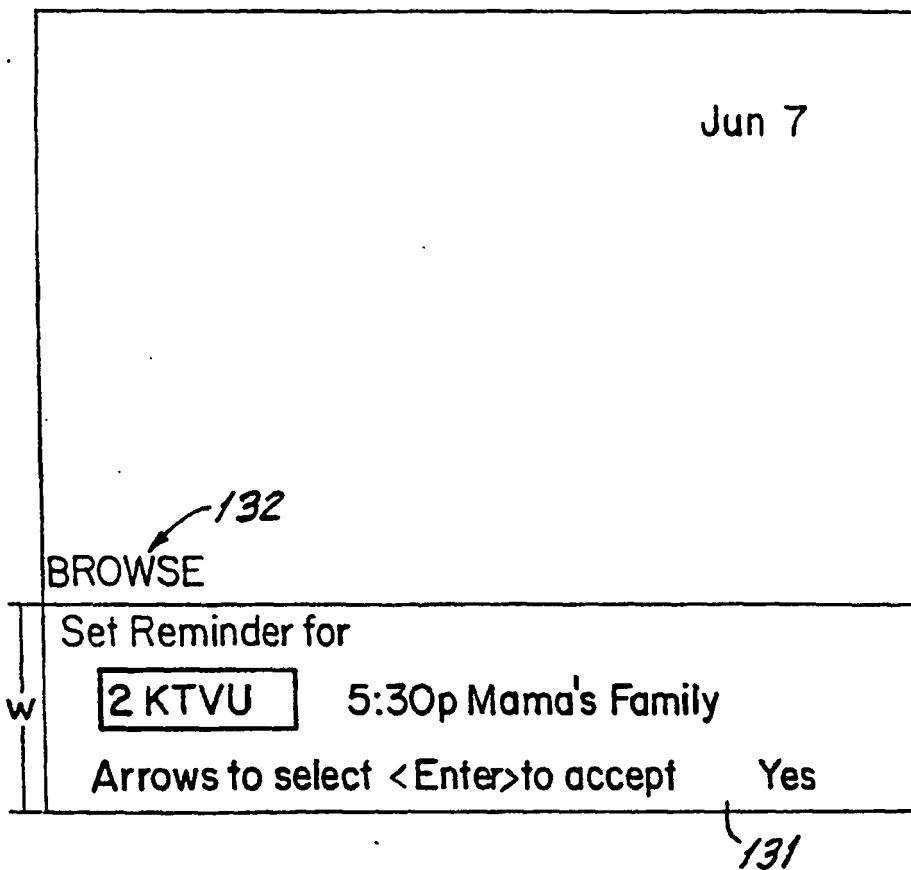

FIG.13

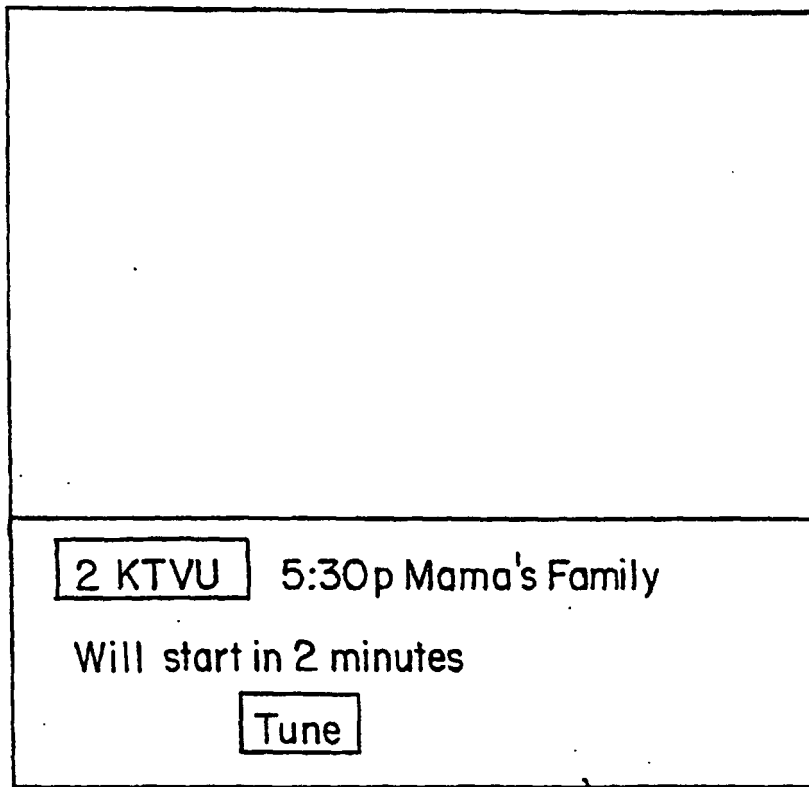

FIG.14

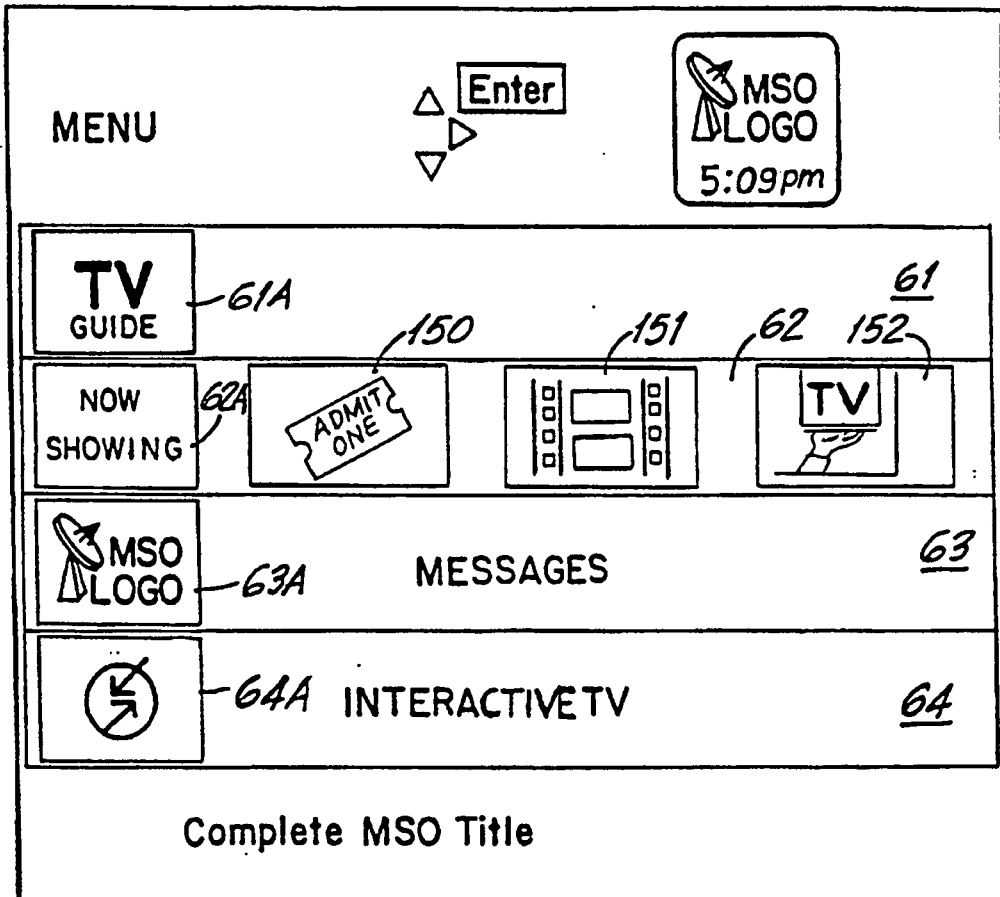

FIG.15

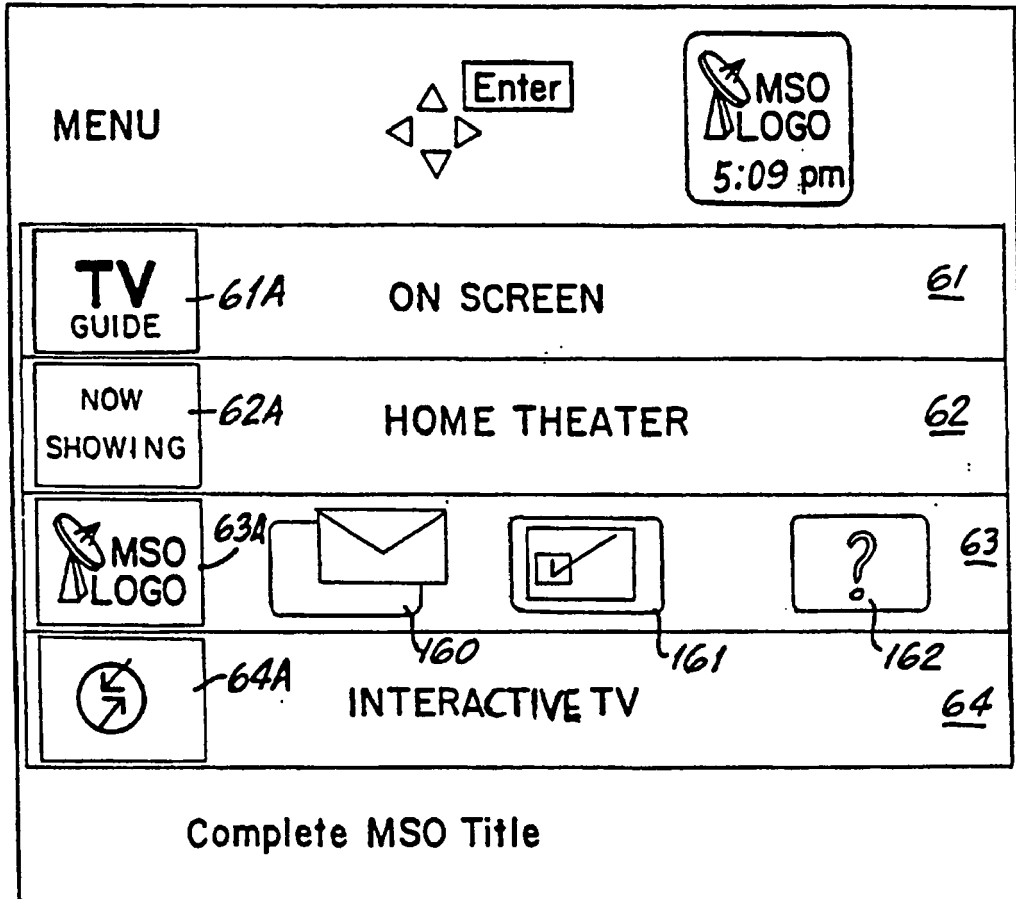

FIG.16

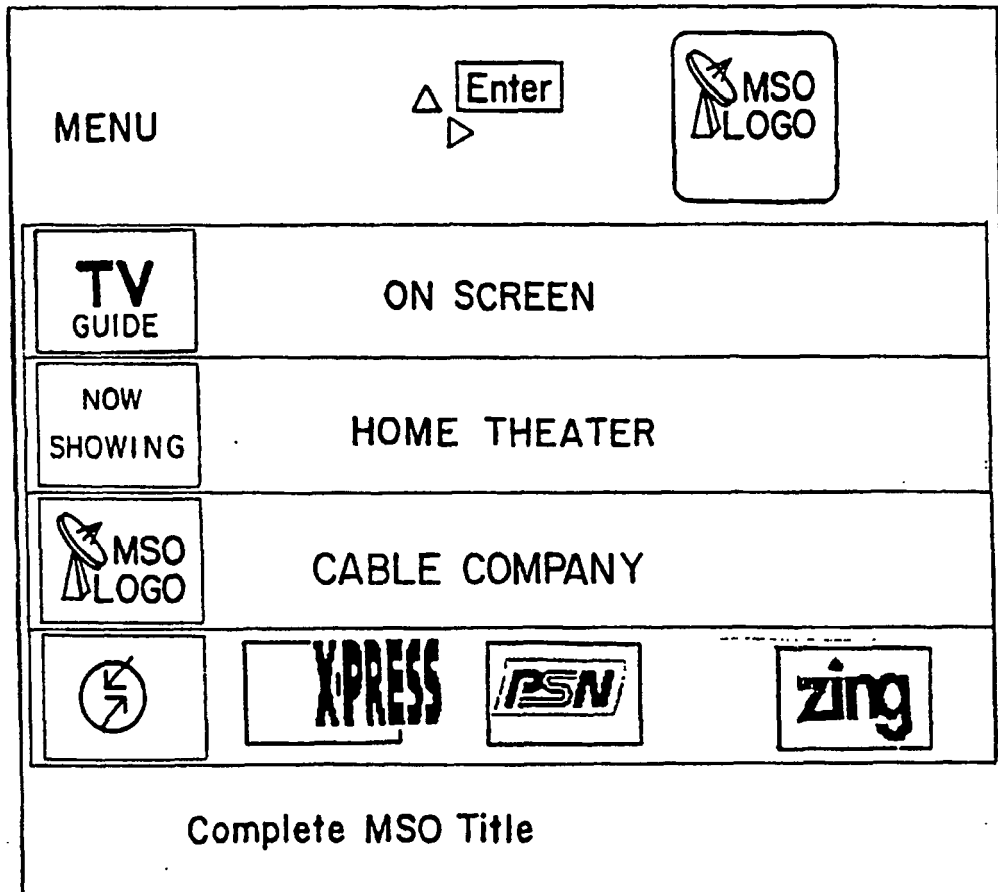

FIG.17

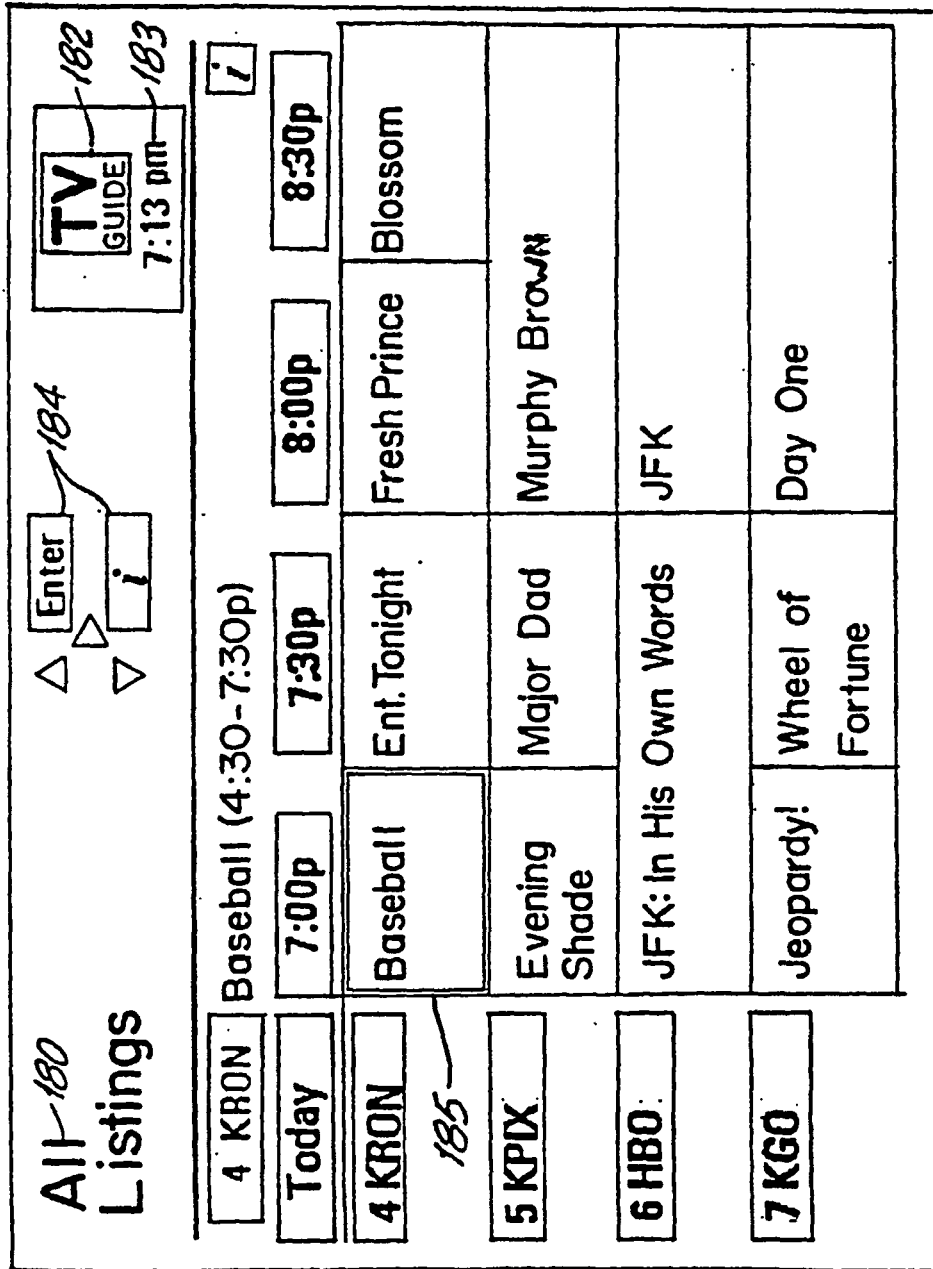

FIG. 18

Listings By TV GUIDE 5:45 pm
 Category *190A* / *190B* Enter i *190D* *190C*
Movies Sports News Children
 _____ Today _____

22 LIF	4:00p A Case of DeadlyForce	i
1 HOT	4:00p Ring of Fire II: Blood and Steel	i
34 AMC	4:00p Texas Across the River	i
31 MAX	4:00p The Ballad of the Sad Cafe	i
8 SHO	5:00p Big Girls Don't Cry-They Get Even	i
46 BRV	5:00p Queen of Hearts	i
27 TMC	5:00p The Roaring Twenties	i
25 TBS	5 05p No Mercy	i

FIG. 19

Listings By *201*

Channel *202a* *202b* *202c*

182

183

Today *203*

4:30p Baseball	<input type="button" value="i"/>
7:30p Entertainment Tonight	
8:00p Fresh Prince	
8:30p Blossom	
9:00p PerryMason: Notorious Nun	<input type="button" value="i"/>
11:00p News	
11:30 Tonight	
12:30a David Letterman	

FIG. 20

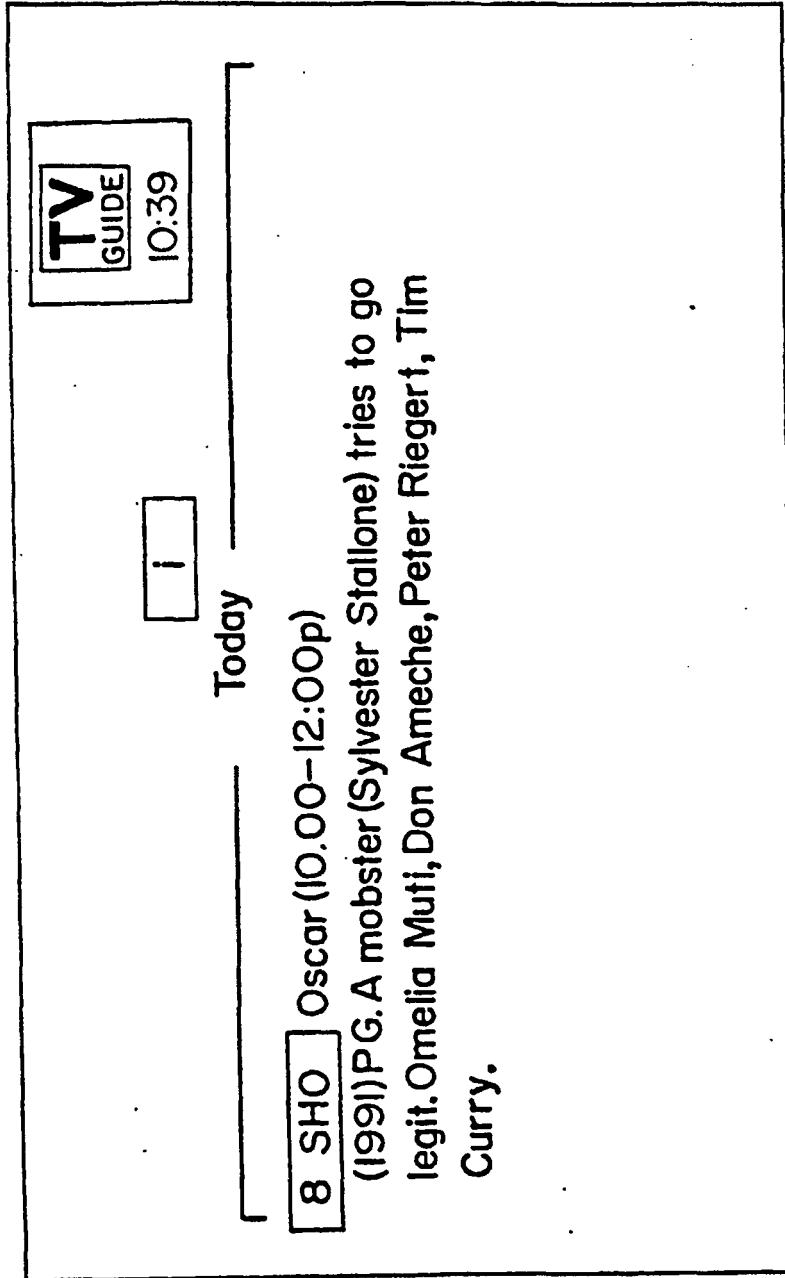

FIG. 21

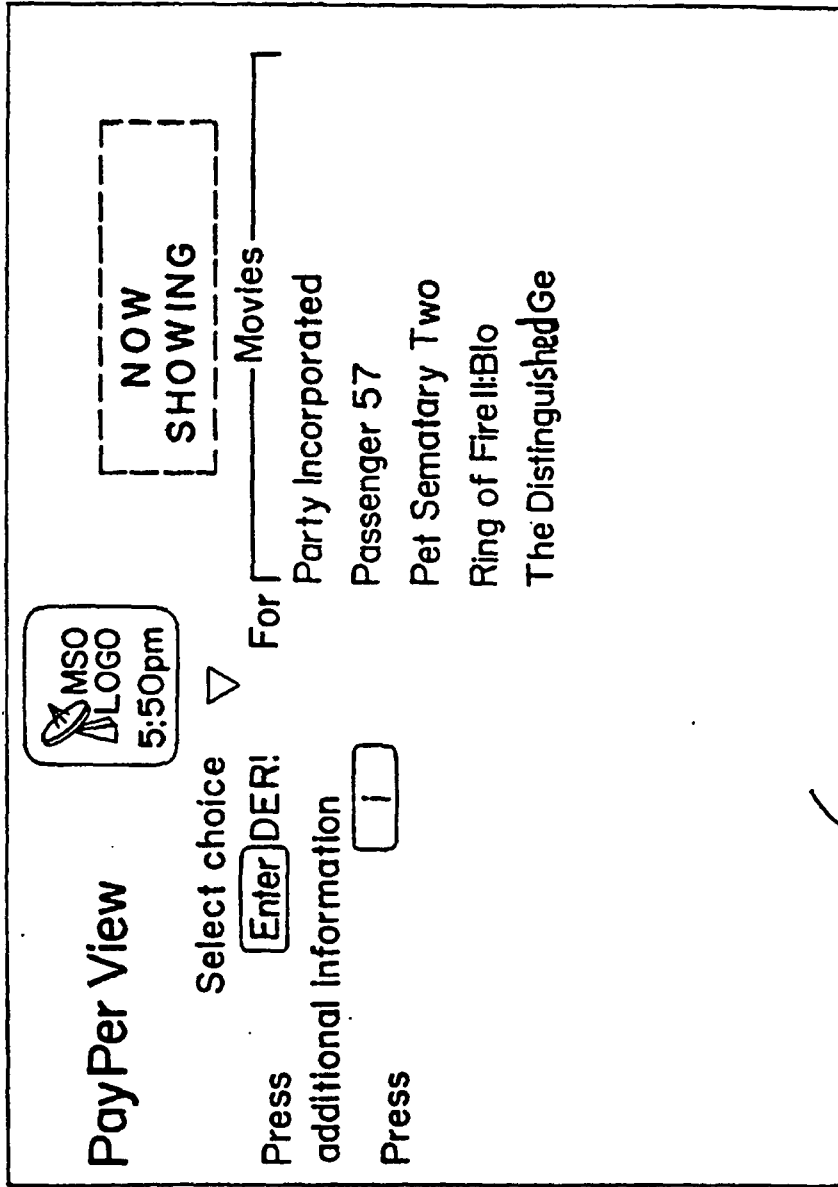

FIG. 22

Pay Per View
Ordering

Enter

MSO
LOGO
5:49 PM

\$ 3.99

Passenger 57

What time would you like this show to start?

Today 9:00p ^{230B} Tomw 12:00p ^{230C} Tomw 6:00p

230A

Would you like to see a countdown onscreen
just before the show start

Yes No

PPV /
/Source

FIG.23

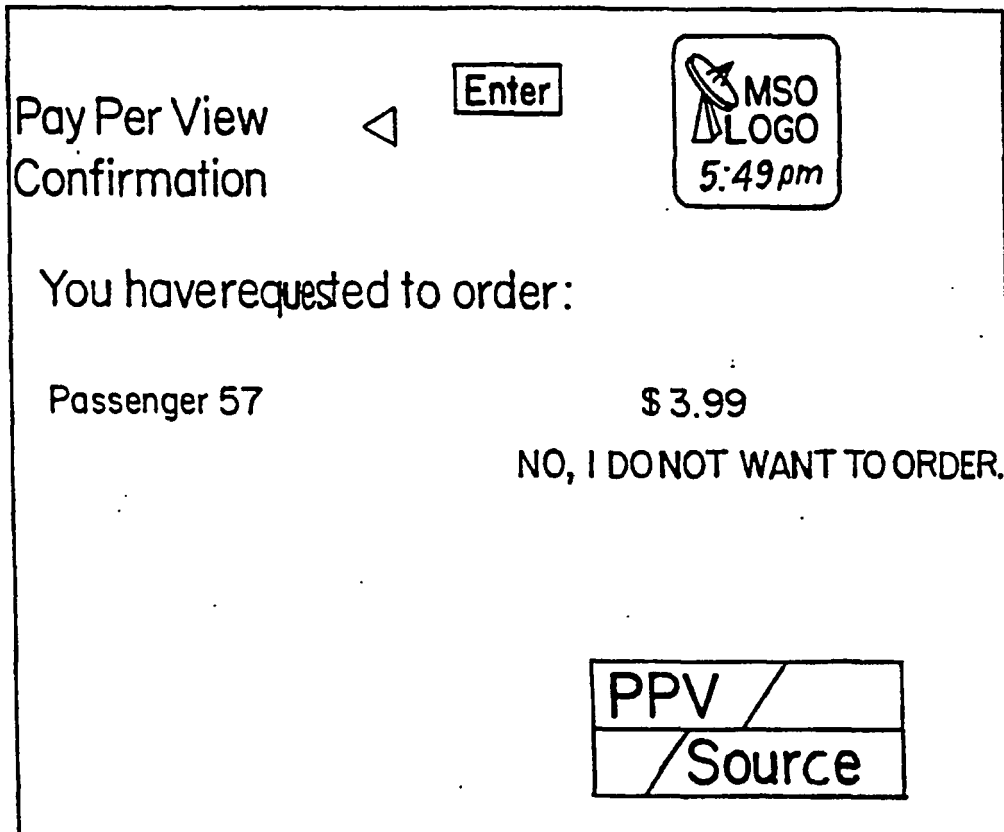

FIG.24



FIG.25

Premium Services	<input type="button" value="Enter"/>	
<input type="button" value="HBO"/>	Home BoxOffice \$10.40/Month	
<input type="button" value="SHO"/>	Showtime \$9.95/Month	
<input type="button" value="DIS"/>	The Disney Channel \$9.95/Month	
<input type="button" value="TMC"/>	The Movie Channel \$1.50/Month	
<input type="button" value="MAX"/>	Cinemax \$9.95/Month	
<input type="button" value="PLA"/>	Playboy at Night \$4.95/Evening(5:00pm to 3:00am)	
<input type="button" value="ACT"/>	Action \$5.95/Day(11:00pm to 3:00pm)	
Movie, special events, and family programming!		
You are not a Subscriber. Press <input type="button" value="Enter"/> to Subscribe!		

FIG.26

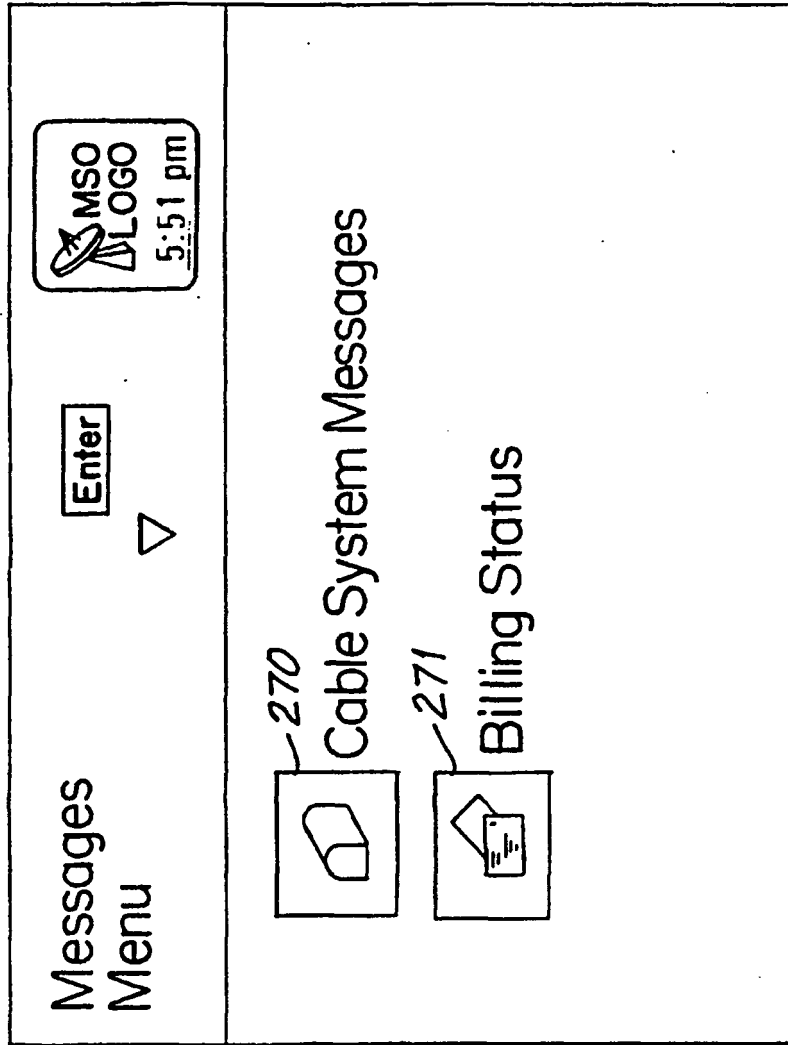

FIG.27

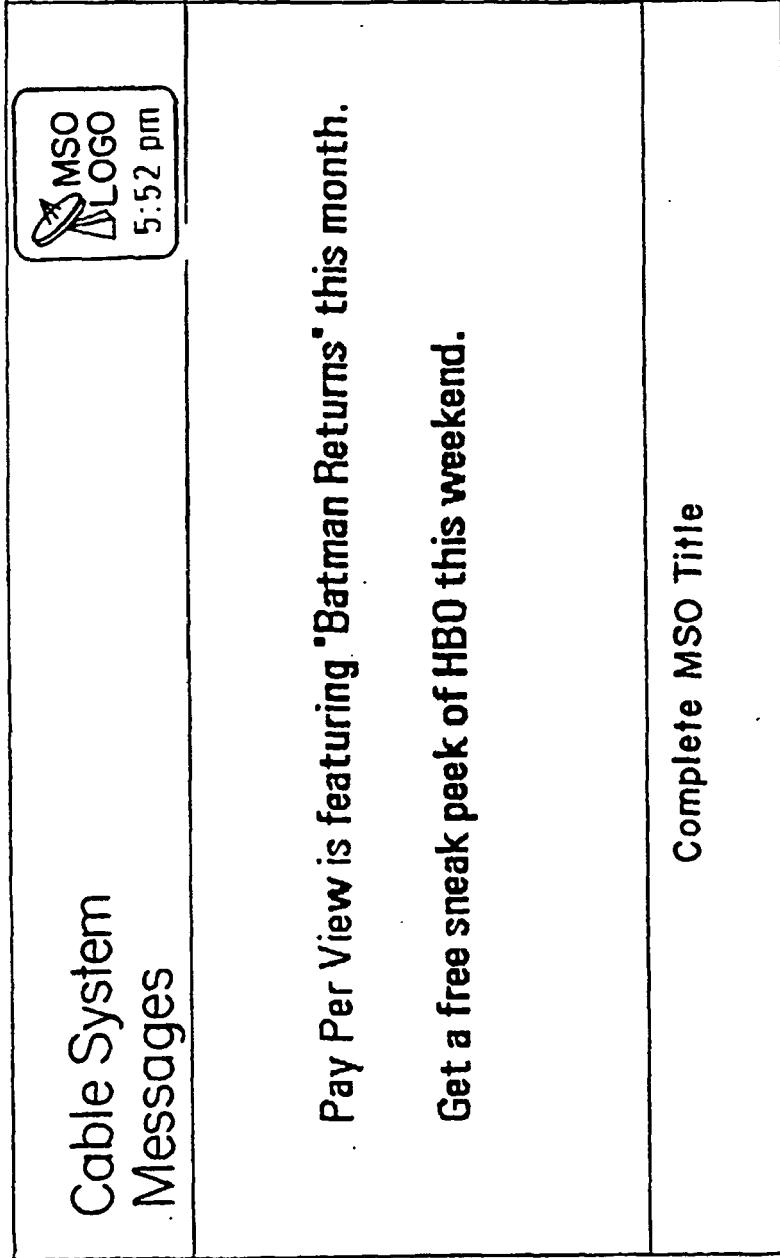

FIG.28

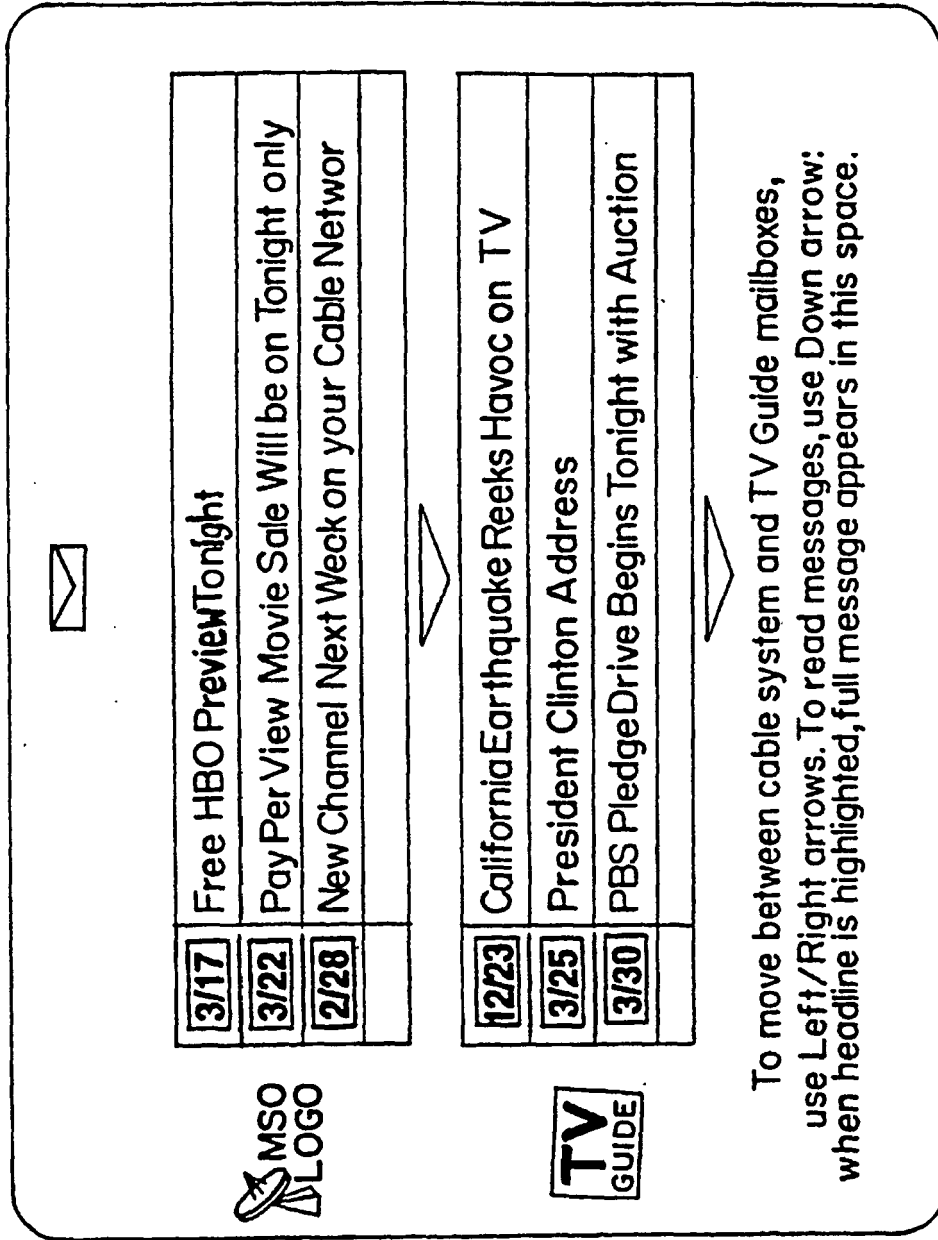

FIG. 28A

Billing			
Name:	TV Guide Onscreen	Acct.#:	12345-098765-08-9
Billed From:	05/25/93	Billed To:	06/25/93
FOR CUSTOMER SERVICE CALL: 790-0900		Total:	\$3.99
Date	Time	Service / PPV Event	Cost
06/07/93	9:00 p	PASSENGER 57	\$3.99

FIG.29

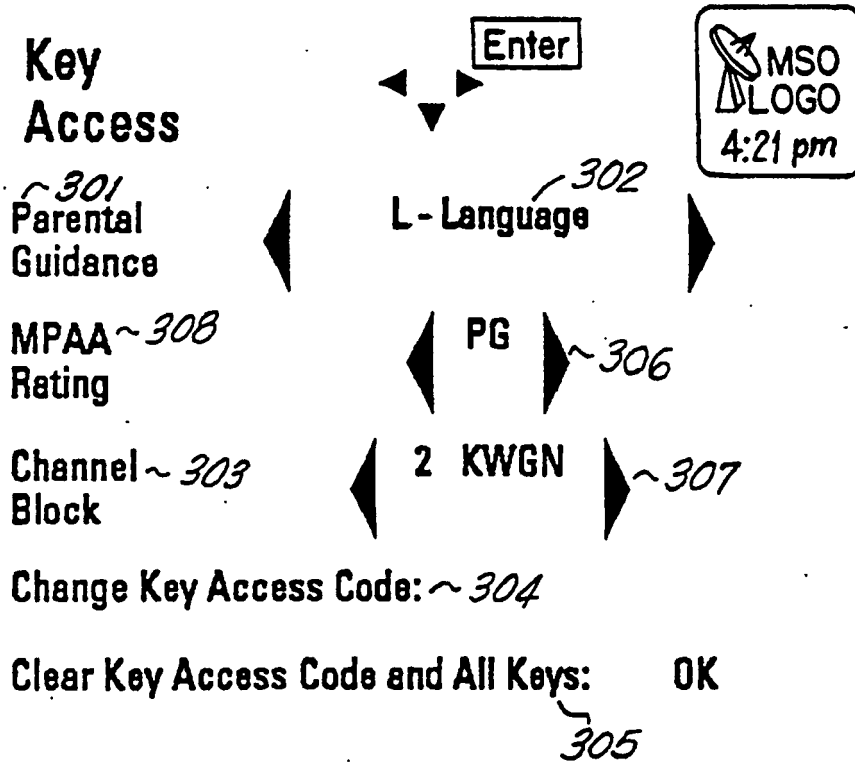

FIG.30

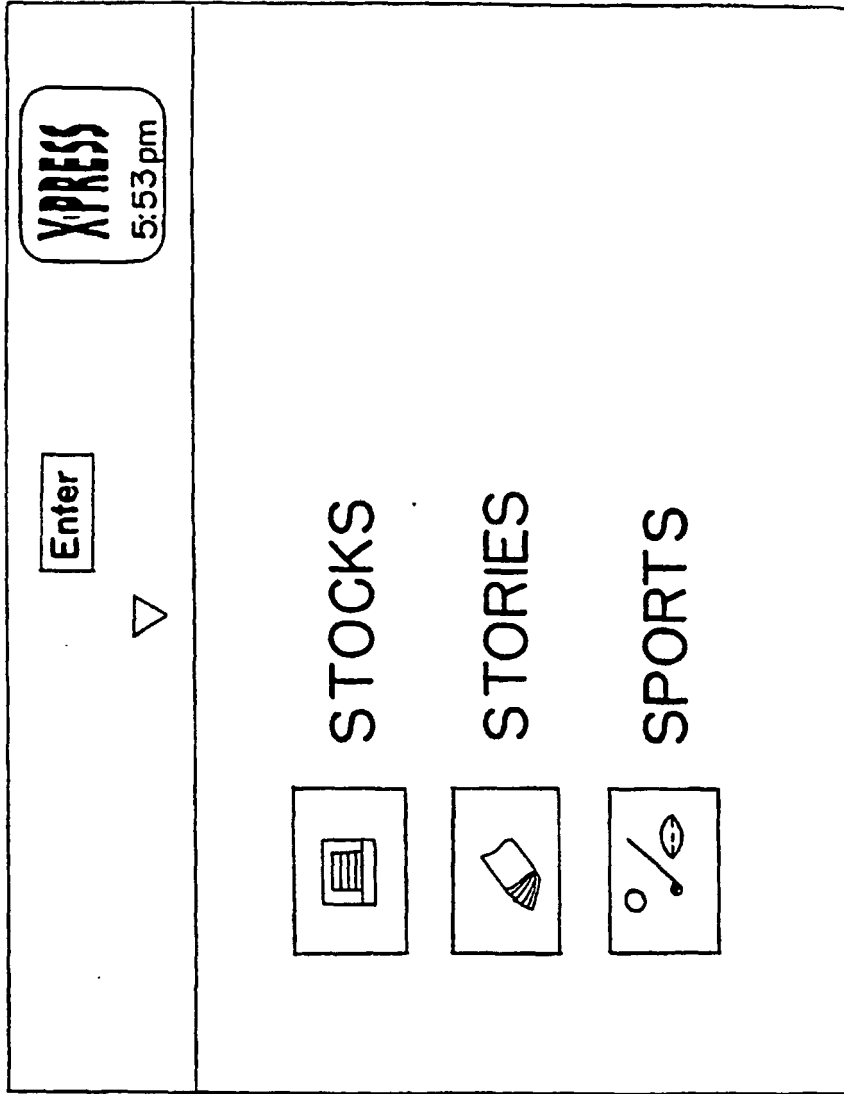

FIG. 31

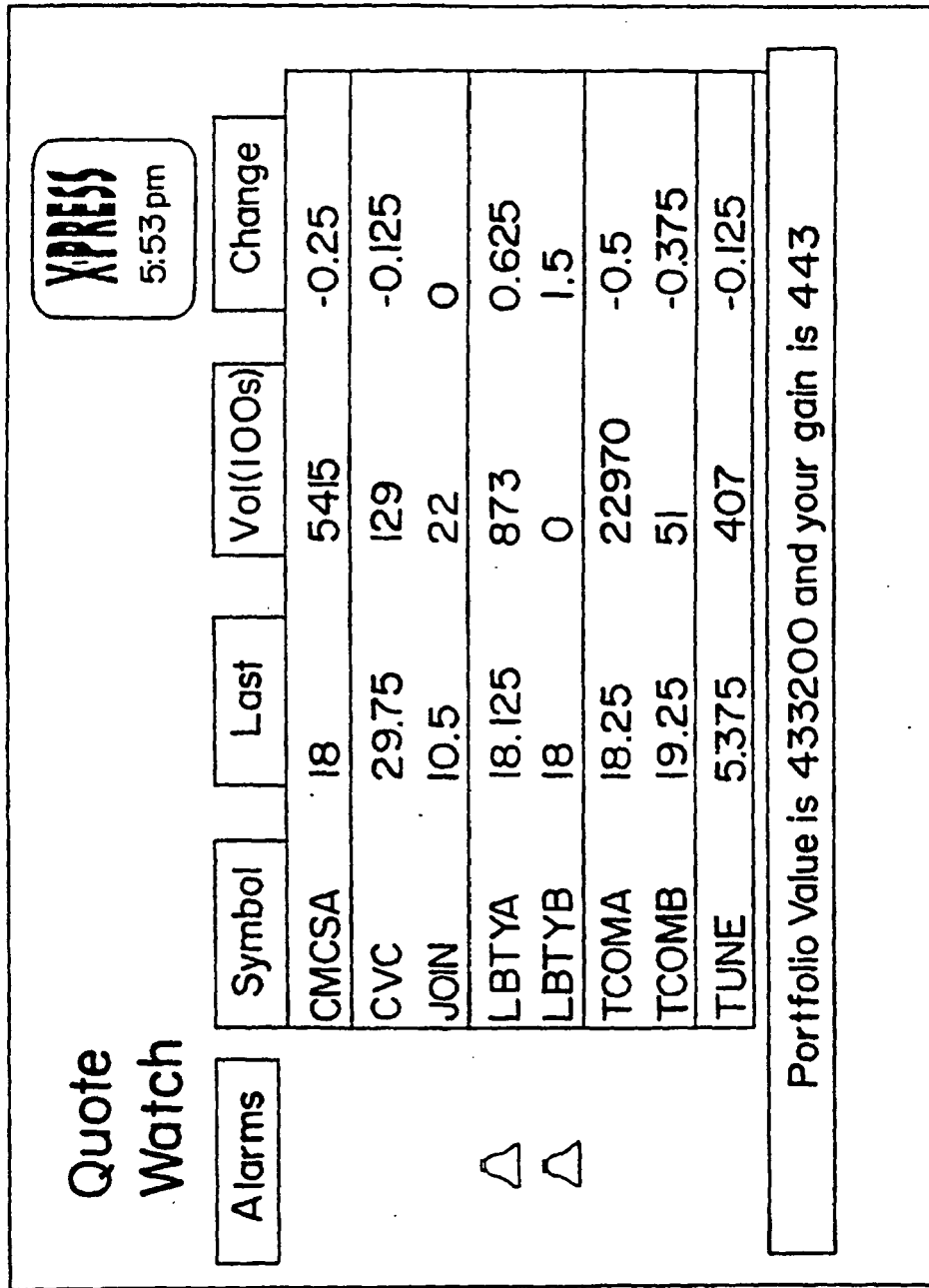

FIG. 32

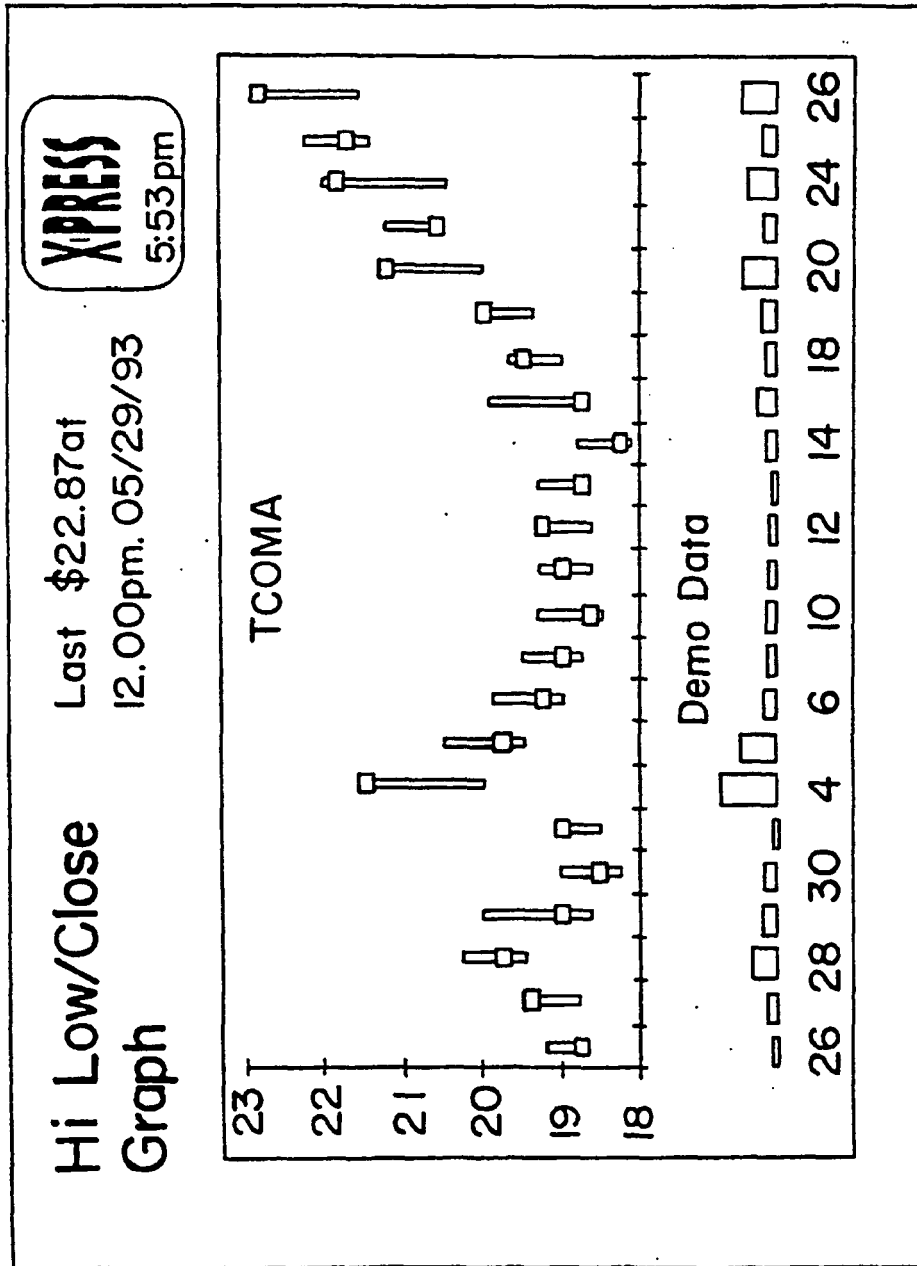

FIG. 33

STORIES



US World News

Cubans use Vitamins to combat epidemic

Geneva - A costly campaign to provide vitamins to all Cubans has helped curb a mysterious epidemic that has afflicted thousands with vision problems, a World Health Organization official said yesterday.

The outbreak of optical neuritis has dimmed the vision of about 20,000 Cubans and a related malady has affected 6,000 other people, mostly women.

FIG.34

SPORTS



Major League Baseball

Yesterday in National League Action

Colorado 7, Houston 5

San Francis co 5, Chicago 4

Yesterday in American League Action

Detroit 4, Boston 1

Toronto 4, Milwaukee 2

FIG.35

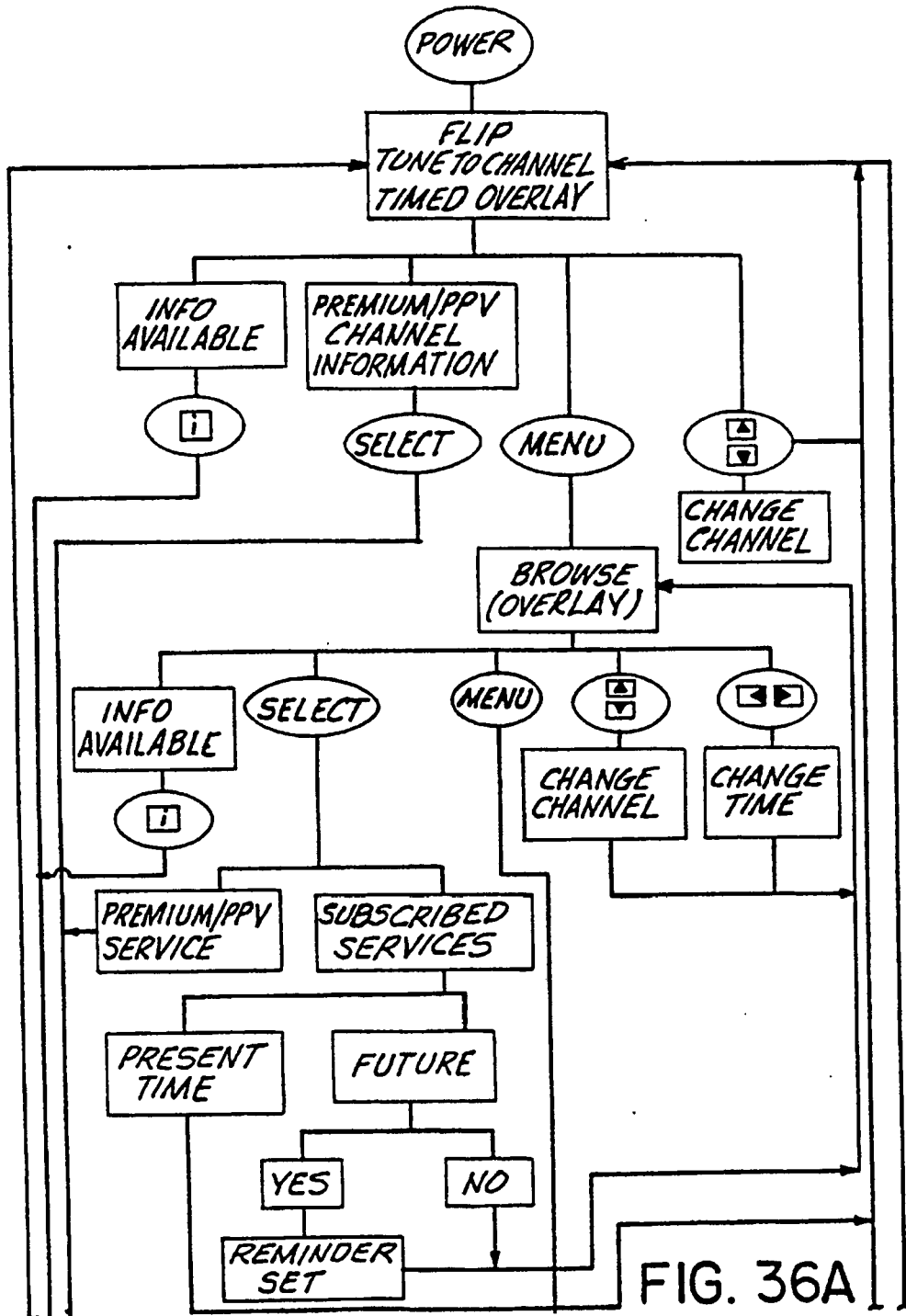

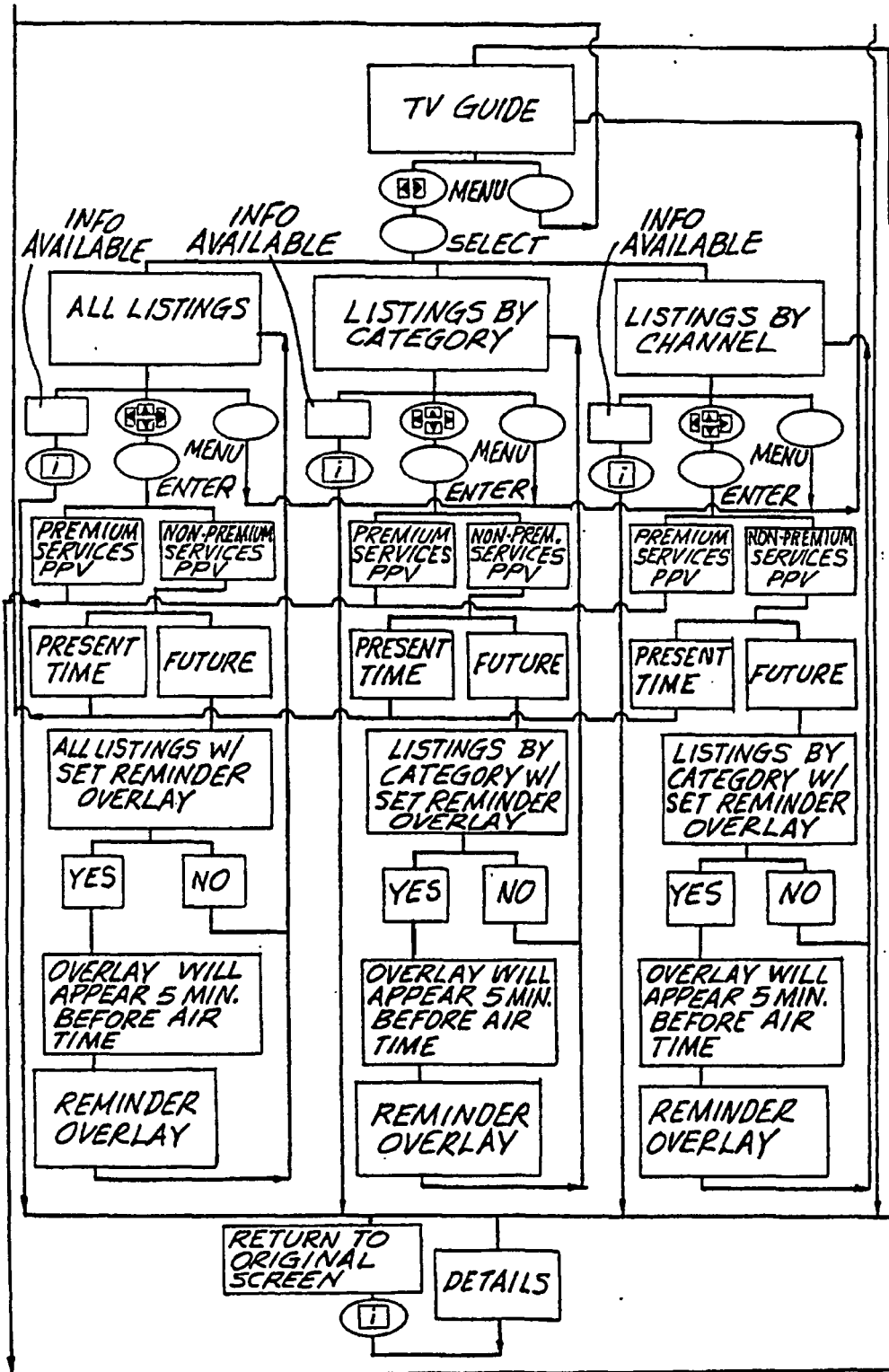

FIG 36B

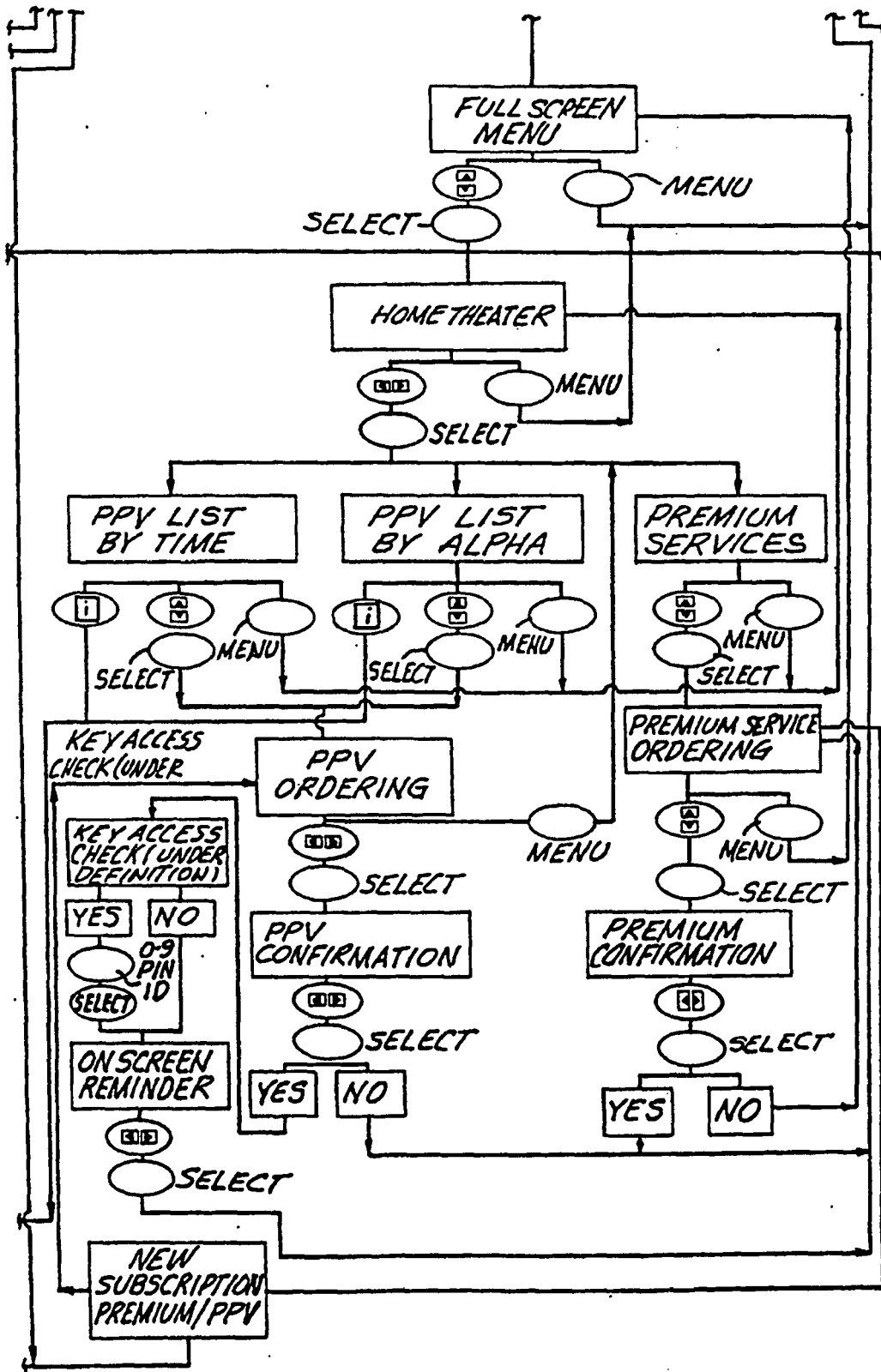

FIG. 36C

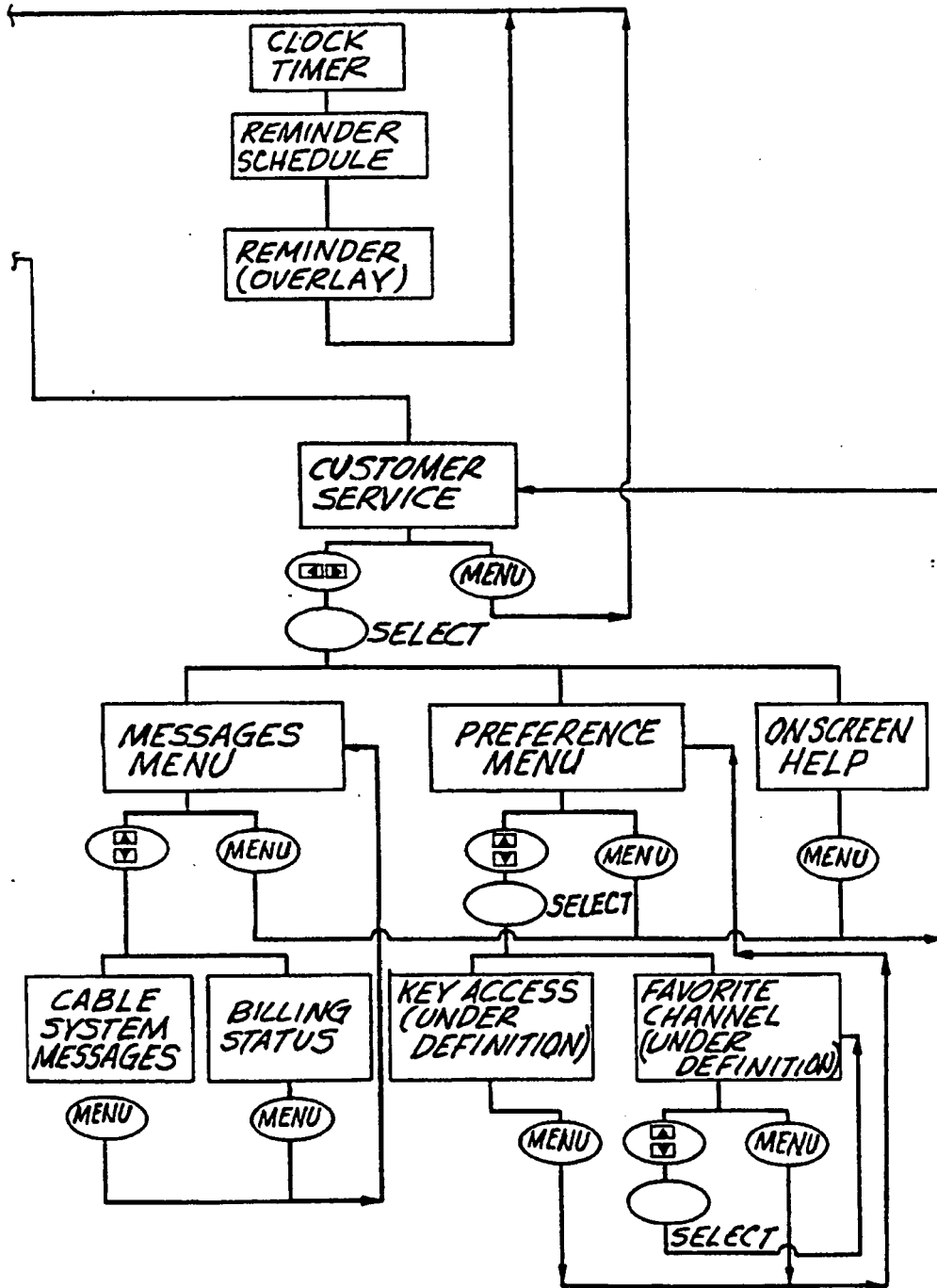

FIG. 36D

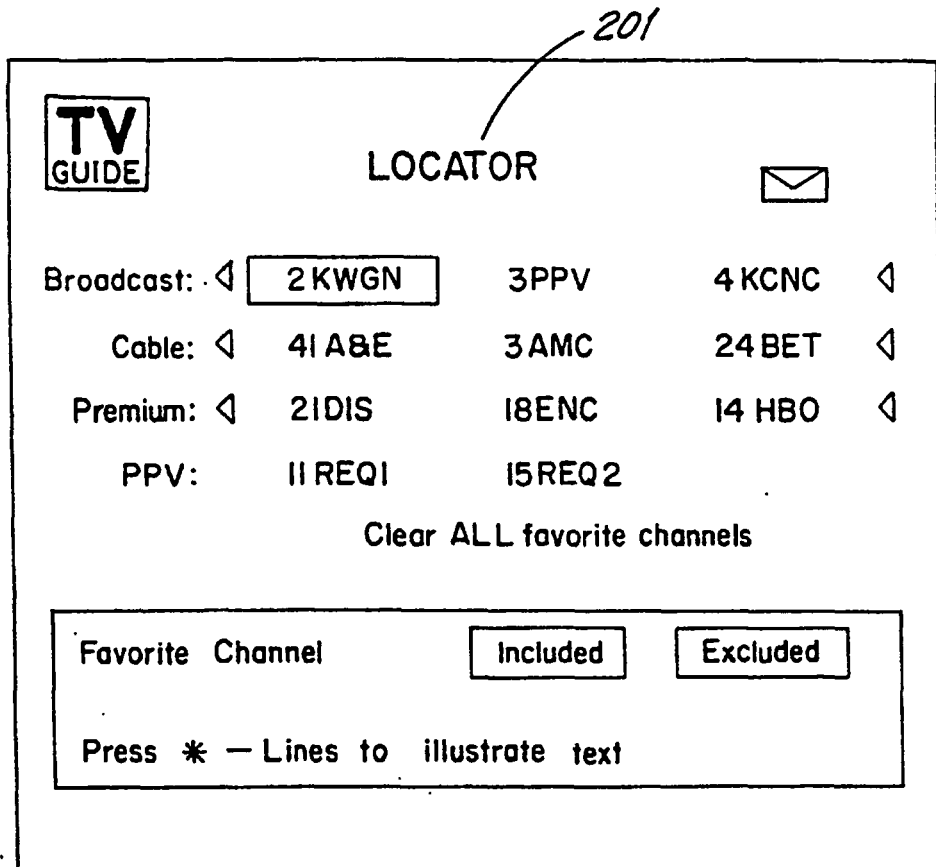

FIG. 37

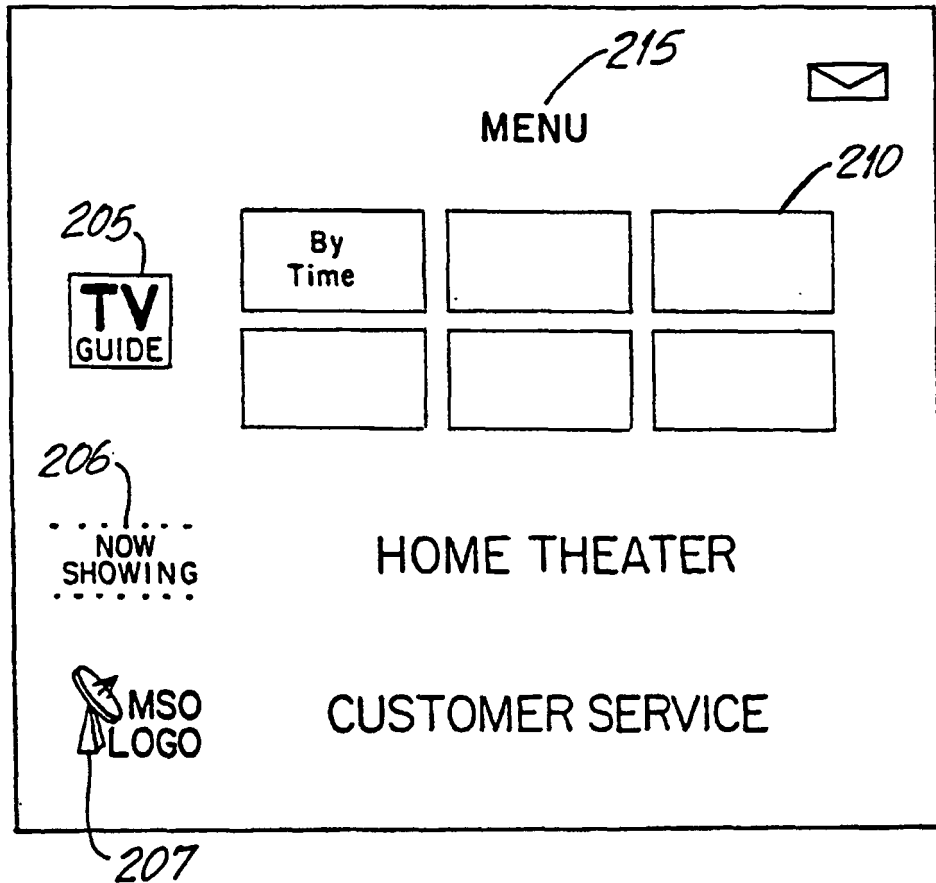

FIG.38

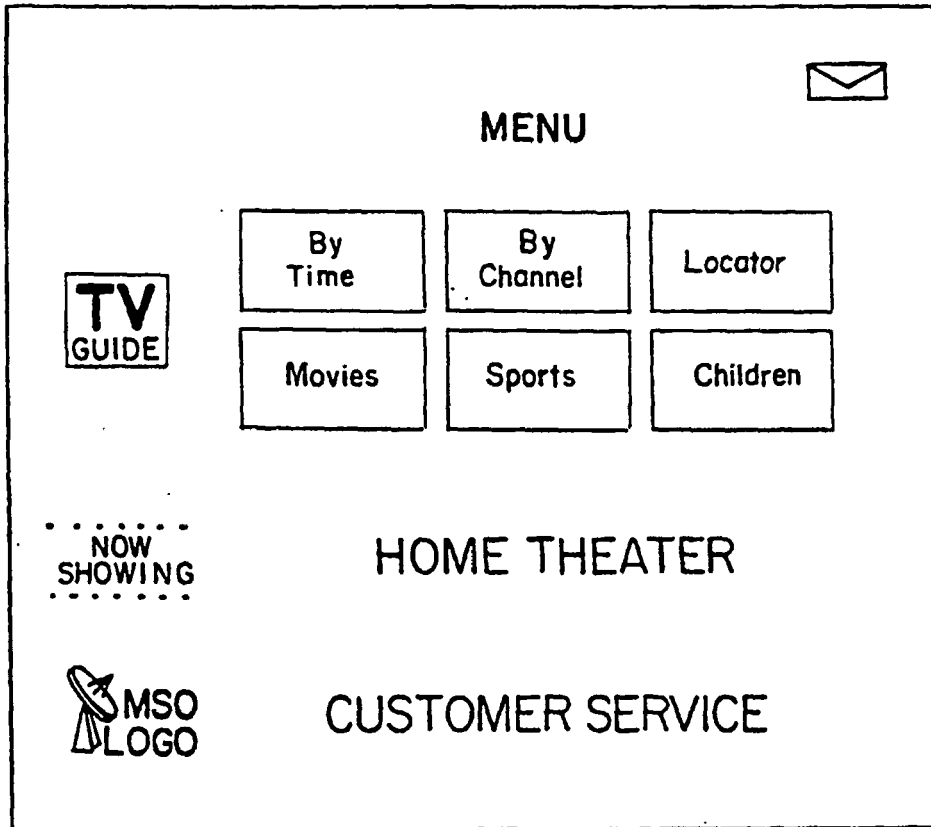





FIG.38A







TODAY 7:30PM



Extra Extra Line

51 CSPN2 Gov't Program (10-10a)

1

52 SPICE **Mom and Dad Save the World (4-6p)**

1

53 KWHD Religious Programming (12-12m)

54 MUN2 Public Access (12-12m)

2 KWGN NBA Basketball (6-30-9p)

1

Mom and Dad Save the World \$4.99

You have requested this program at 4PM.

To complete the ordering process,
enter your four-digit purchase code.

Purchase Code:

FIG. 38B

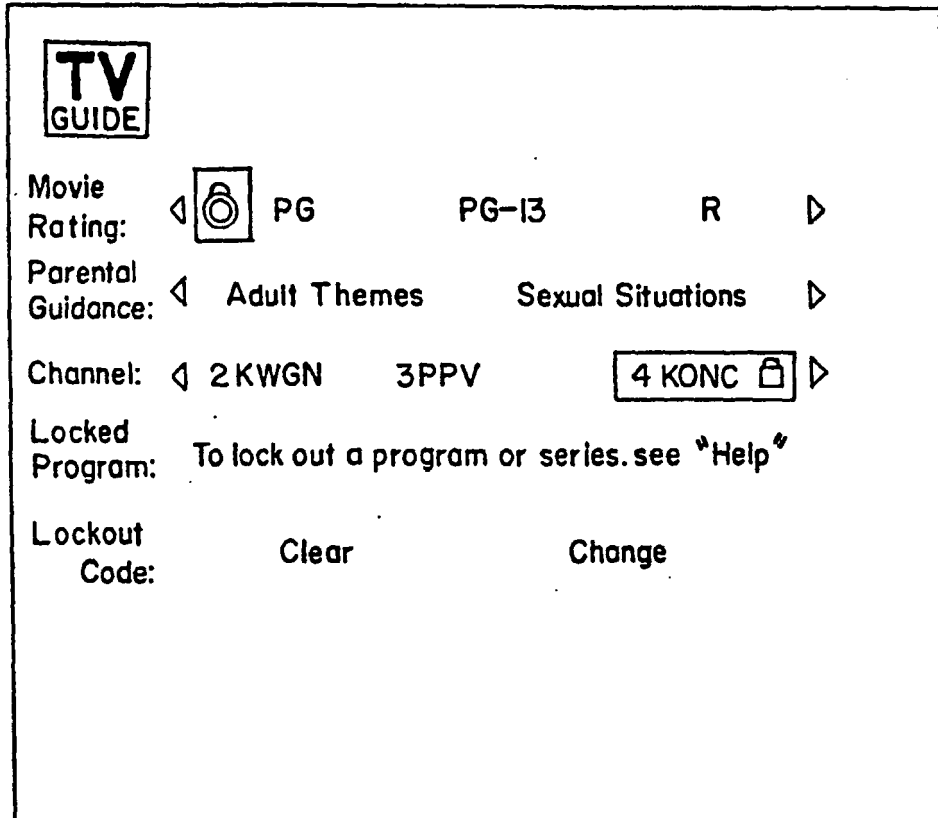

FIG. 39

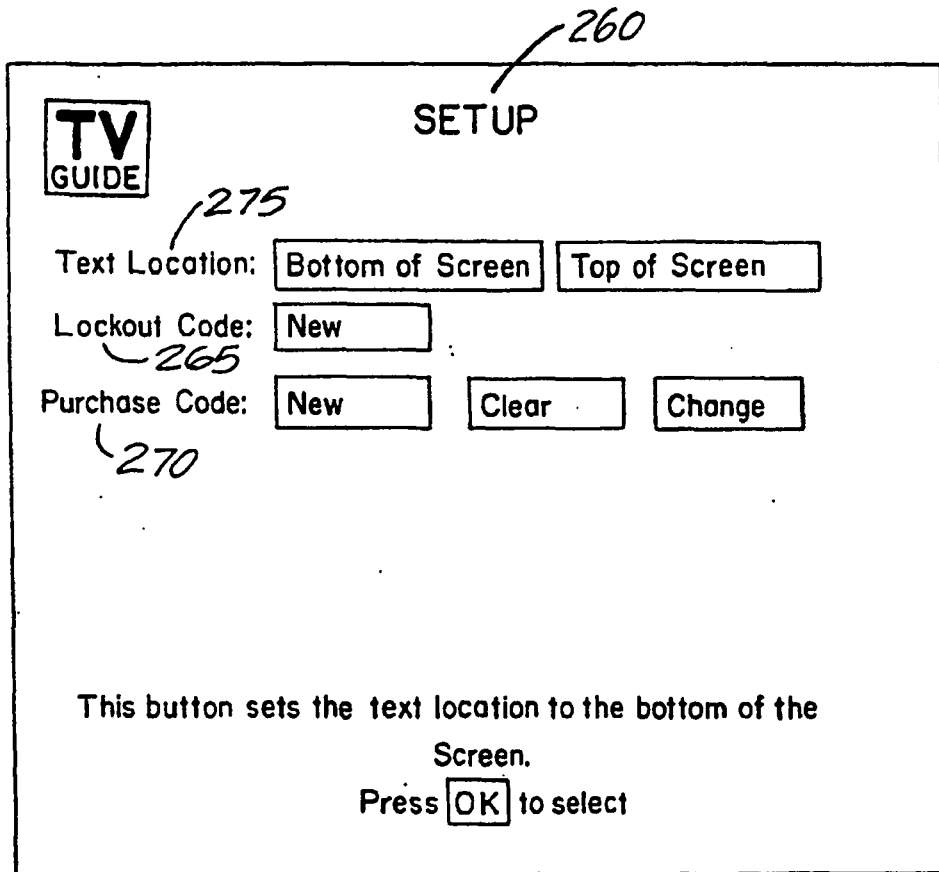

FIG. 40

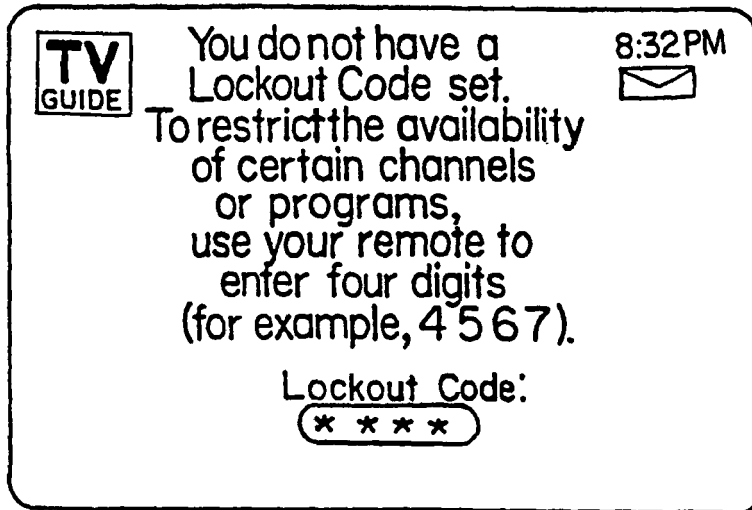

FIG.40A

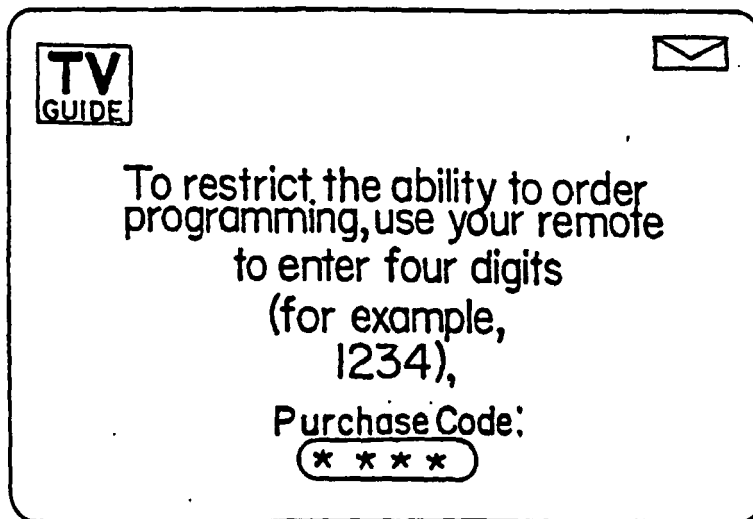

FIG.40B

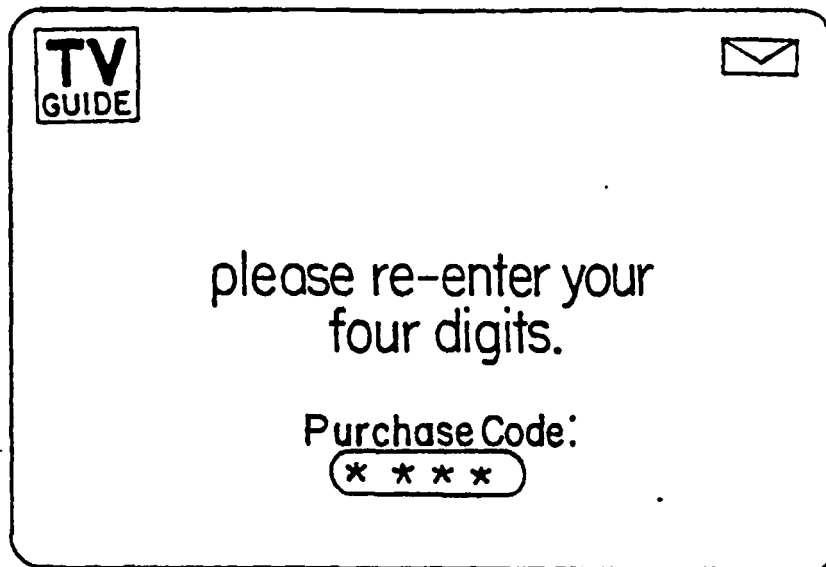

FIG.40C

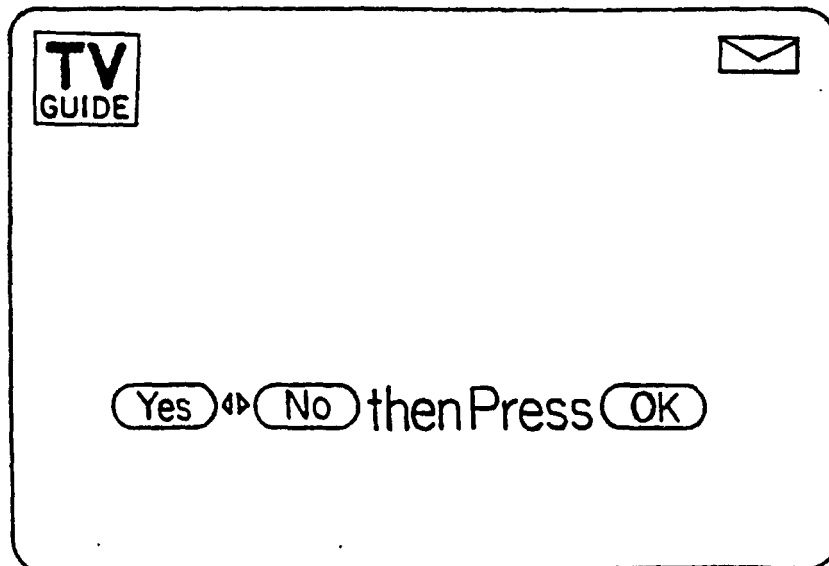

FIG.40D

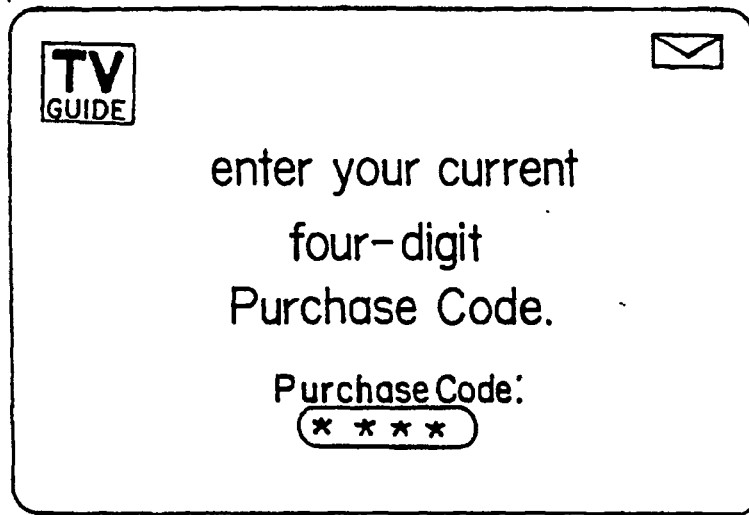

FIG.40E

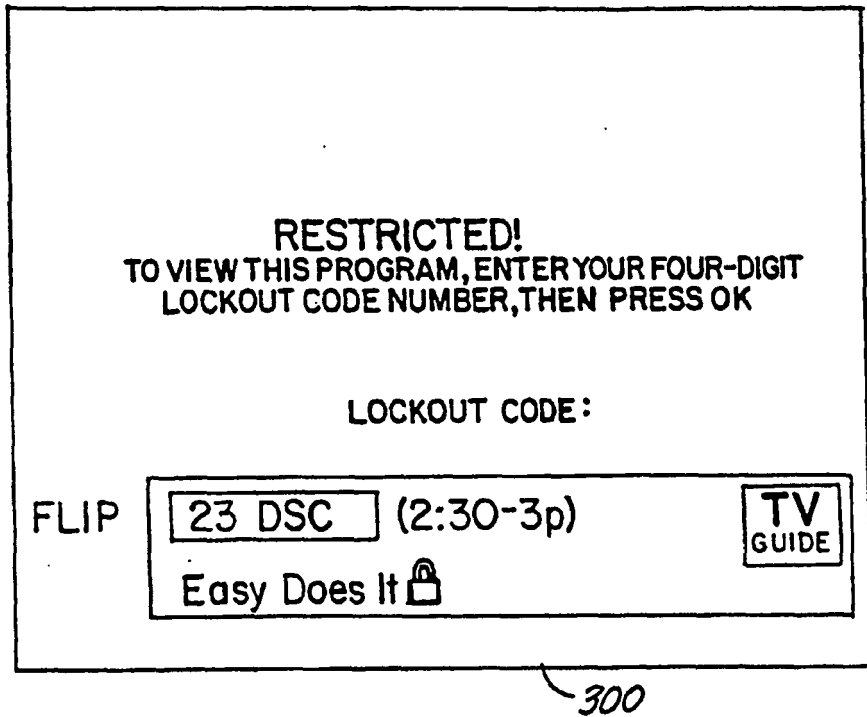

FIG.4I

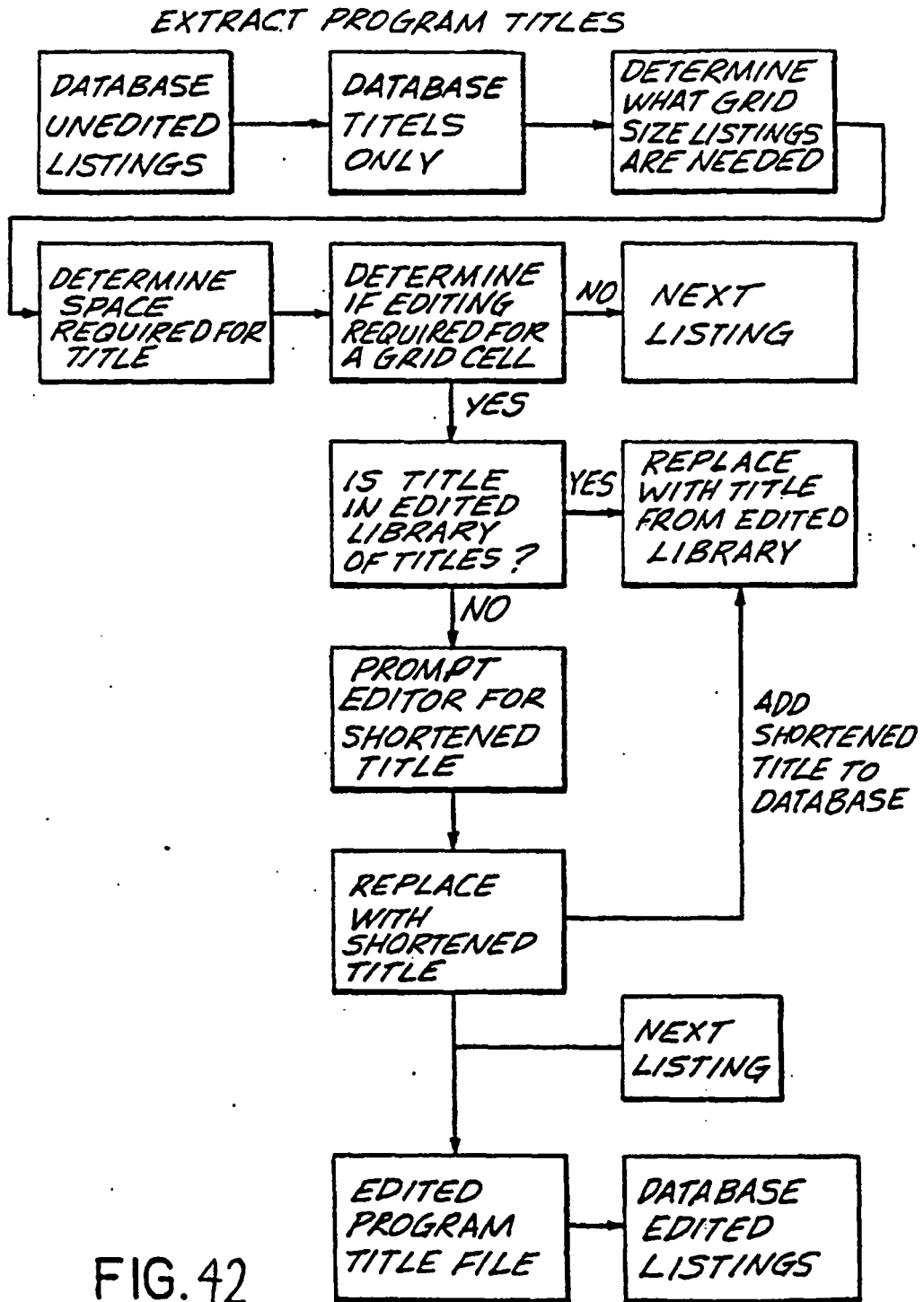

FIG. 42

REFERENCES CITED IN THE DESCRIPTION

This list of references cited by the applicant is for the reader's convenience only. It does not form part of the European patent document. Even though great care has been taken in compiling the references, errors or omissions cannot be excluded and the EPO disclaims all liability in this regard.

Non-patent literature cited in the description

- Stay Tuned for Smart TV. *Popular Science*, November 1990 [0002]