



US00D358166S

United States Patent [19]

[11] Patent Number: **Des. 358,166**

Deutch

[45] Date of Patent: **** May 9, 1995**

[54] **CARD HOLDER**

[57] **CLAIM**

[75] Inventor: **Sidney S. Deutch**, Woodbridge, Canada

The ornamental design for a card holder, as shown and described.

[73] Assignee: **Data Accessories Corporation**, Woodbridge, Canada

DESCRIPTION

[**] Term: **14 Years**

FIG. 1 is a top plan view of the card holder; FIG. 2 is a bottom plan view of the card holder of FIG. 1;

[21] Appl. No.: **9,599**

FIG. 3 is a side plan view of the card holder of FIG. 1; FIG. 4 is a plan view of the other side of the card holder of FIG. 1;

[22] Filed: **Jun. 18, 1993**

FIG. 5 is a side plan view of a second embodiment of FIG. 1, it being understood that the top and bottom are the same as in FIG. 1;

[52] U.S. Cl. **D19/26**

[58] Field of Search D19/26, 27, 28; D3/227, D3/303, 247, 250, 251; 283/63.1, 64; 281/31, 15.1, 21.1, 33, 29, 35

FIG. 6 is a plan view of the other side of the card holder of FIG. 5;

FIG. 7 is a side plan view of a third embodiment of FIG. 1, it being understood that the top and bottom are the same as in FIG. 1;

[56] References Cited

U.S. PATENT DOCUMENTS

- D. 188,525 8/1960 Seitz D3/250
- D. 216,173 11/1969 Kognitt D19/26 X
- D. 243,525 3/1977 Summers et al. D19/26
- D. 250,591 12/1978 Testro et al. D19/26
- D. 251,093 2/1979 Testro et al. D19/26
- D. 279,113 6/1985 Beall D19/26
- D. 316,108 4/1991 Gerriet D19/26
- D. 328,096 7/1992 Gordon D19/26
- 2,815,126 12/1957 Deckers D3/247 X
- 4,932,520 6/1990 Ciarcia et al. 229/72 X

FIG. 8 is a plan view of the other side of the card holder of FIG. 7;

FIG. 9 is an end view of the card holder of FIG. 1;

FIG. 10 is an end view of the card holder of FIG. 5;

FIG. 11 is an end view of the card holder of FIG. 7;

FIG. 12 is a perspective view of the interior of the card holder of FIG. 1 when the card holder is in the open position;

FIG. 13 is a plan view of the interior of the card holder of FIG. 1 when the card holder is in the open position, with the verticle center broken away for ease of illustration only;

FIG. 14 is a plan view of the exterior of the card holder of FIG. 1 when the card holder is in the open position, with the verticle center broken away for ease of illustration only;

FIG. 15 is an end view of the card holder of FIG. 1 when the card holder is in the open position;

FIG. 16 is an end view of the card holder of FIG. 5 when the card holder is in the open position; and,

FIG. 17 is an end view of the card holder of FIG. 7 when the card holder is in the open position.

FOREIGN PATENT DOCUMENTS

- 8485 of 1904 United Kingdom D19/L229 26
- 199846 7/1923 United Kingdom D3/251

Primary Examiner—James M. Gandy
Assistant Examiner—Pamela Burgess
Attorney, Agent, or Firm—Bereskin & Parr

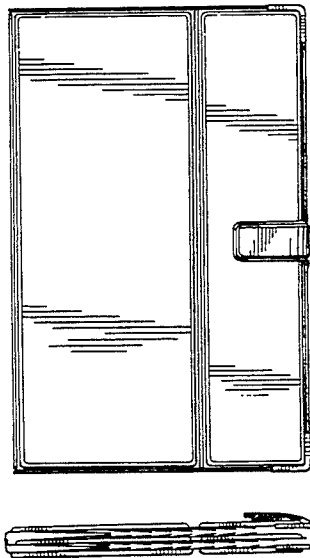

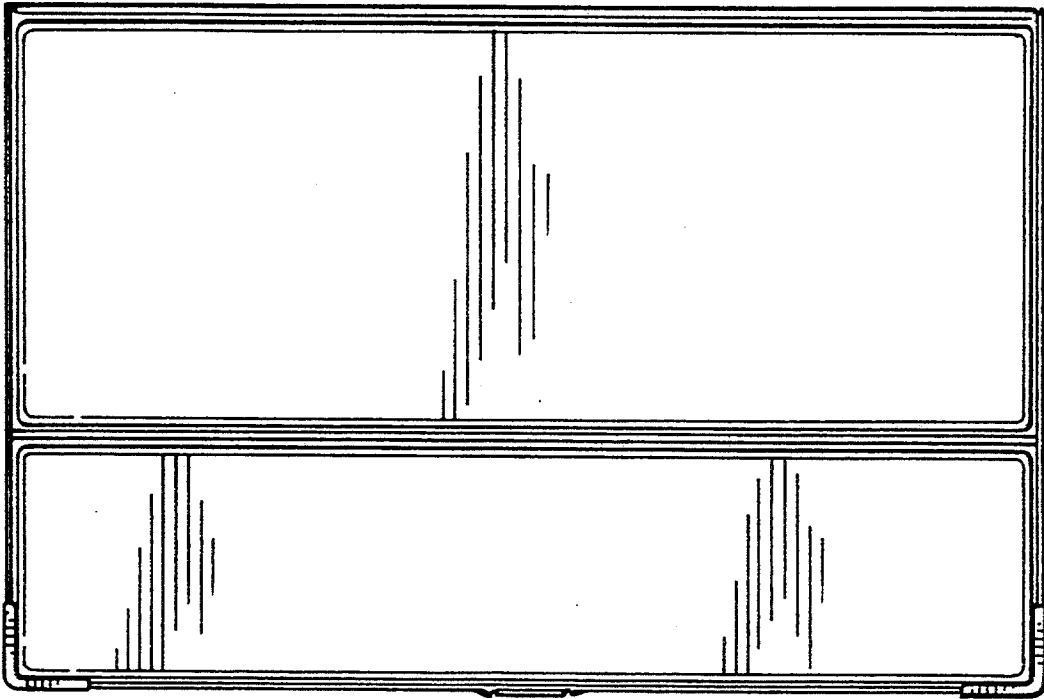

FIG. 2

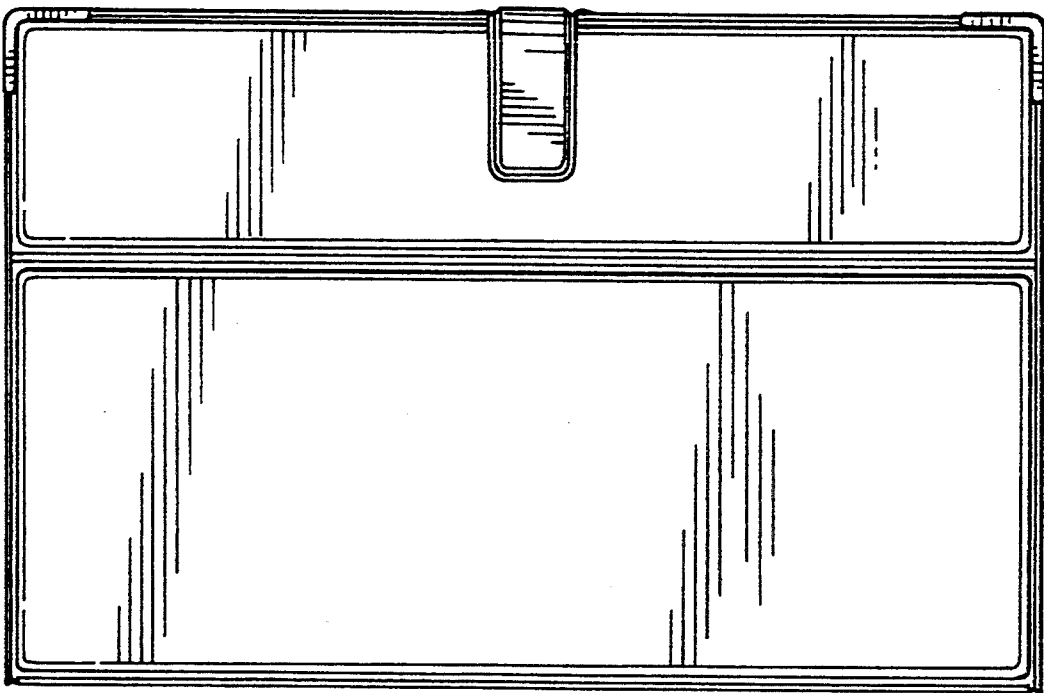

FIG. 1

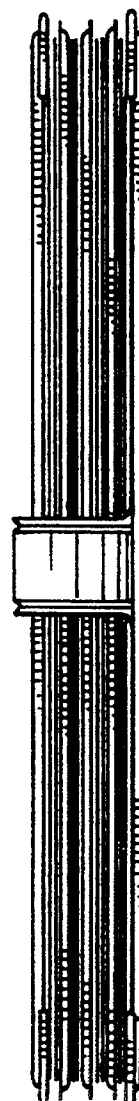
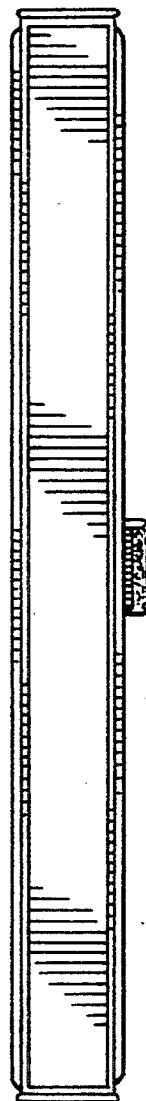
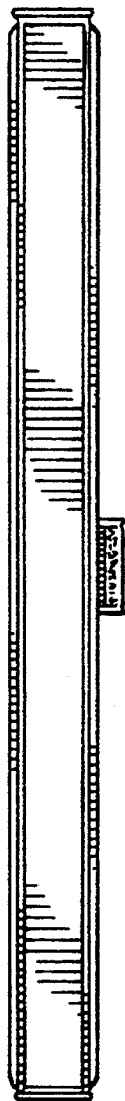

FIG. 3

FIG. 4

FIG. 5

FIG. 6

FIG. 7

FIG. 8



FIG. 9

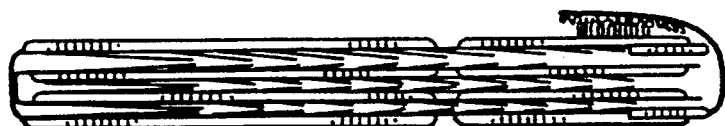

FIG. 10



FIG. 11

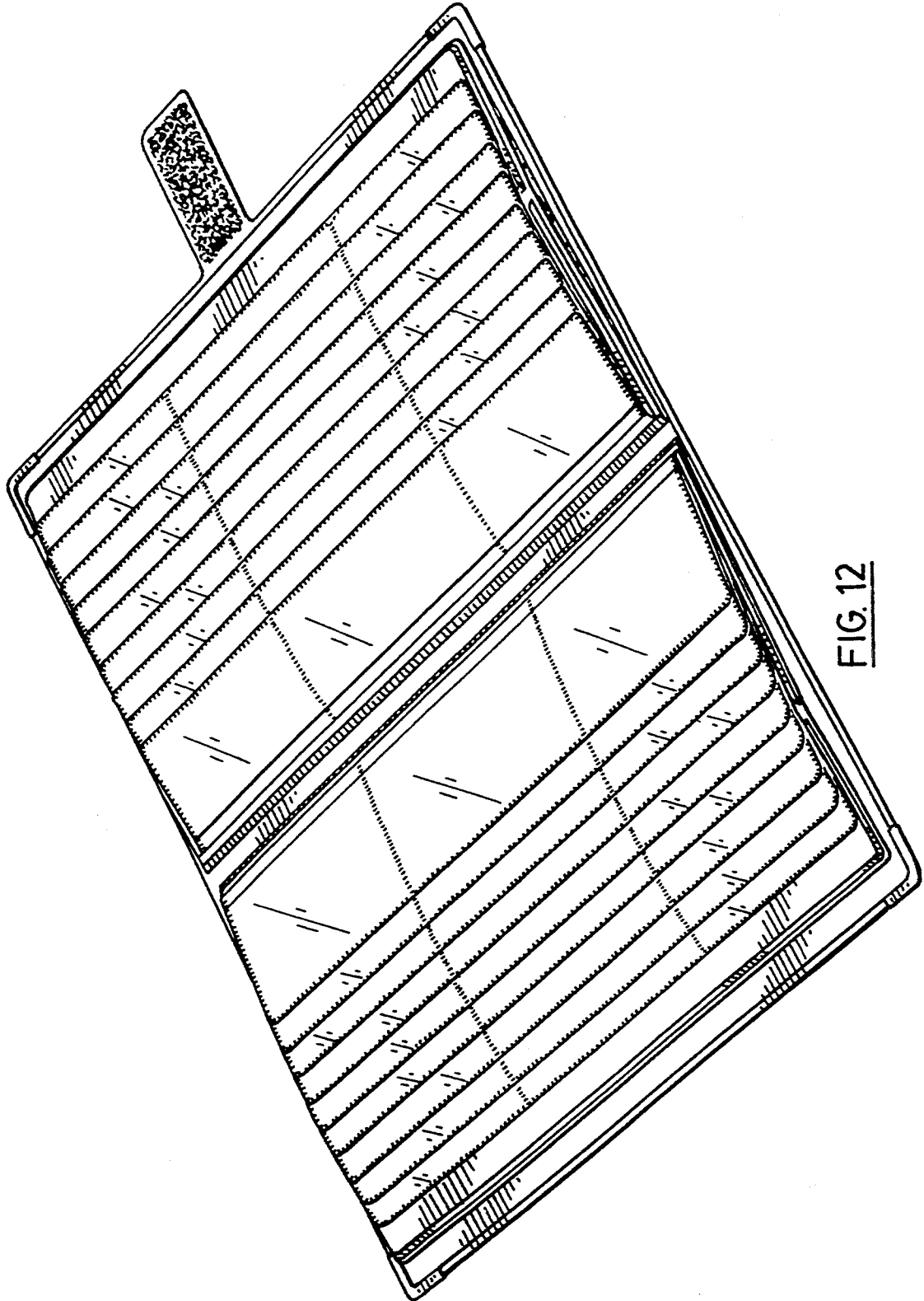

FIG. 12

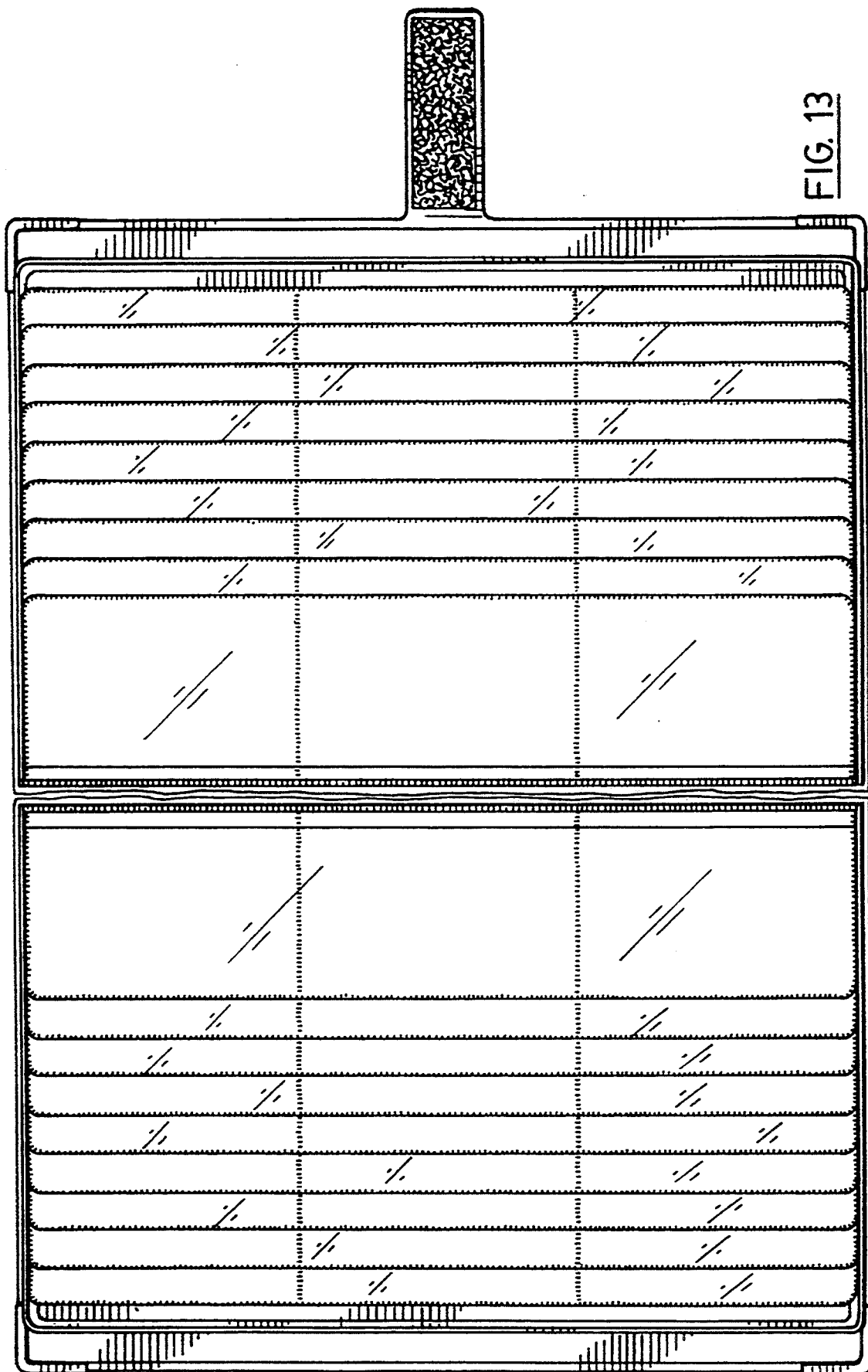

FIG. 13

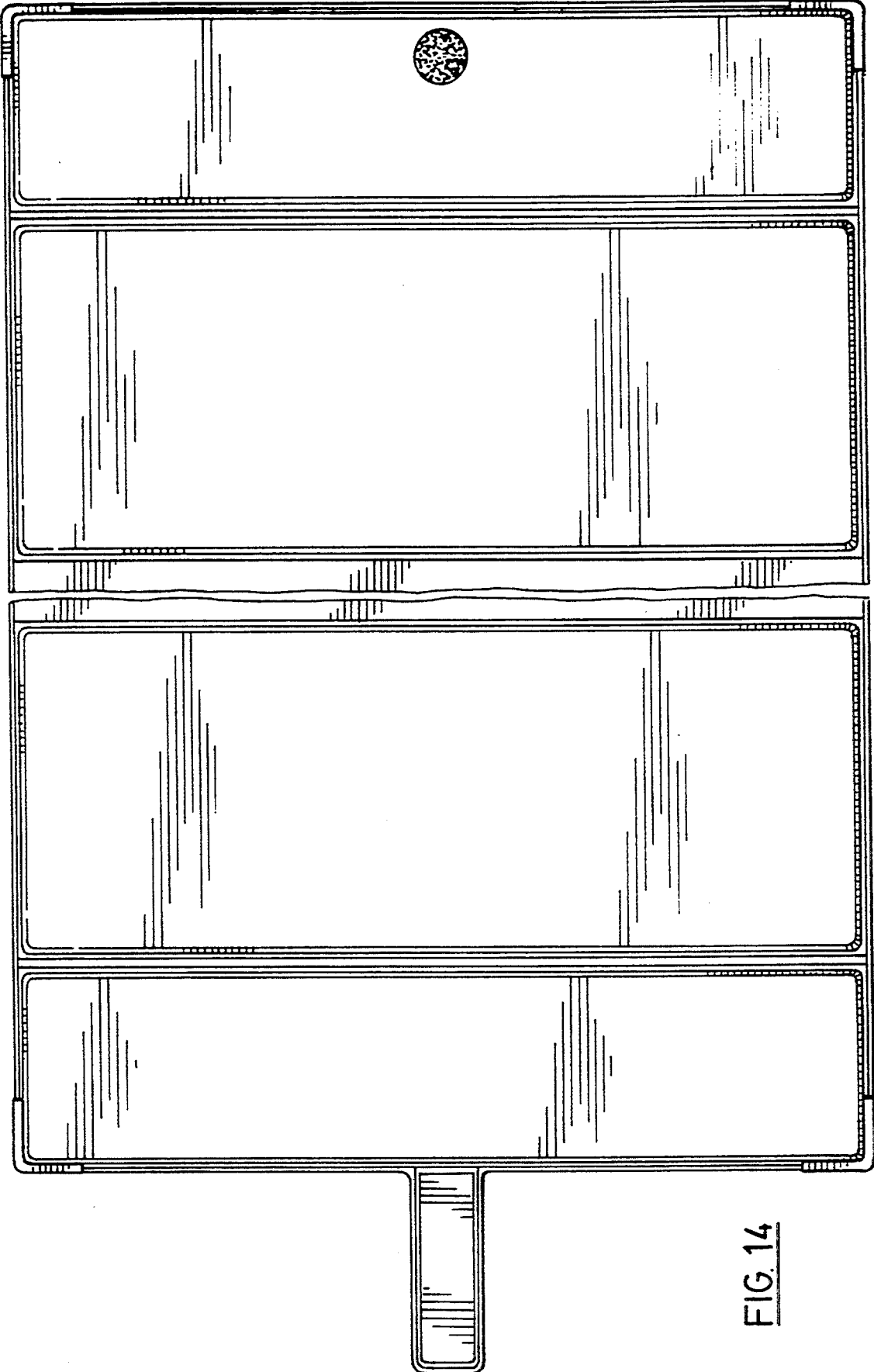

FIG. 14



FIG. 15



FIG. 16



FIG. 17