

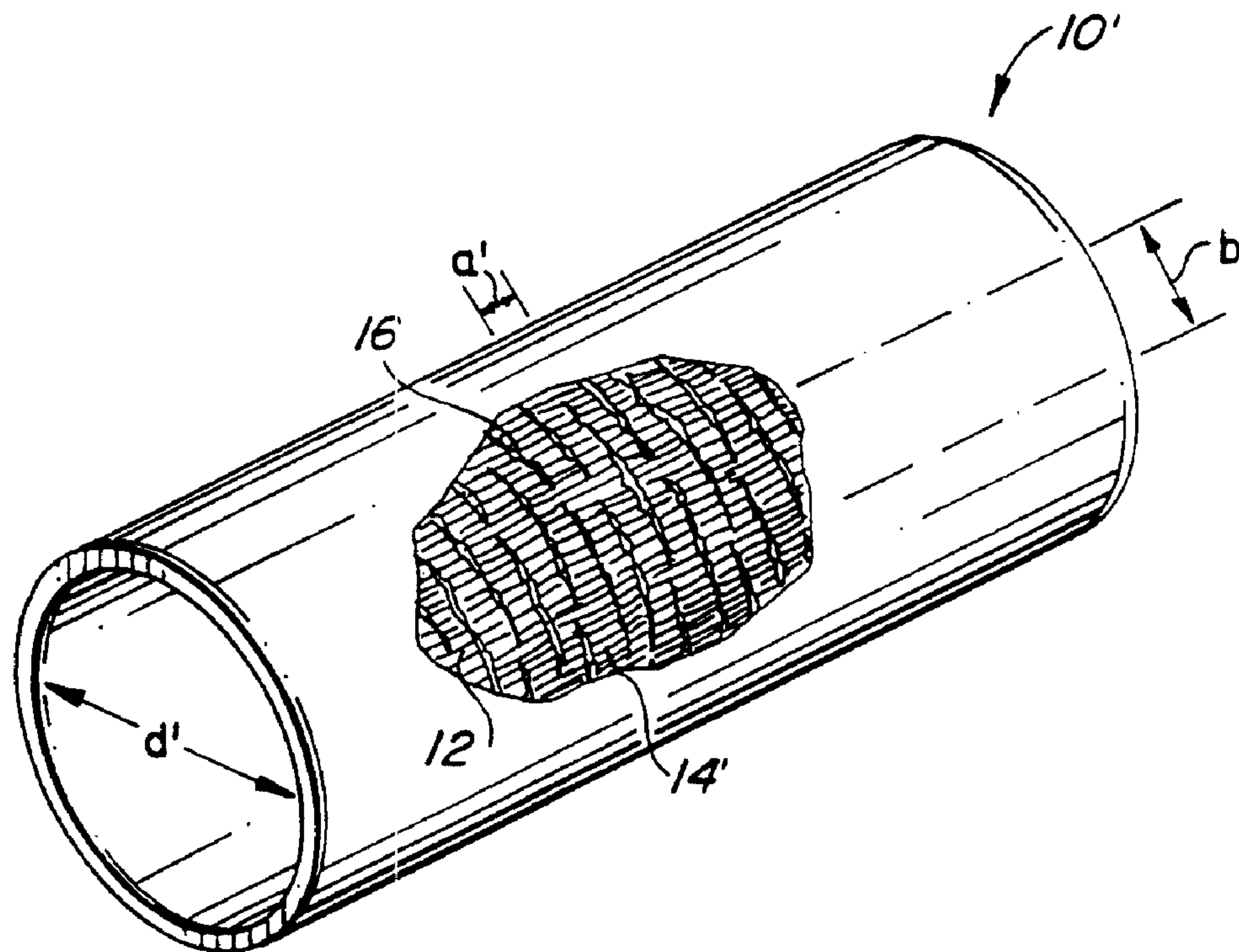

(86) Date de dépôt PCT/PCT Filing Date: 1998/02/02
 (87) Date publication PCT/PCT Publication Date: 1998/08/06
 (45) Date de délivrance/Issue Date: 2007/05/01
 (85) Entrée phase nationale/National Entry: 1999/08/04
 (86) N° demande PCT/PCT Application No.: US 1998/002361
 (87) N° publication PCT/PCT Publication No.: 1998/033453
 (30) Priorité/Priority: 1997/02/05 (US08/794,871)

(51) Cl.Int./Int.Cl. *A61F 2/90* (2006.01),
A61L 27/50 (2006.01), *A61L 31/04* (2006.01)
 (72) Inventeurs/Inventors:
EDWIN, TARUN J., US;
HURRY, FARIBA, US;
BANAS, CHRISTOPHER E., US
 (73) Propriétaire/Owner:
BARD PERIPHERAL VASCULAR, INC., US
 (74) Agent: CASSAN MACLEAN

(54) Titre : IMPLANTS TUBULAIRES EN POLYTETRAFLUORETHYLENE RADIALEMENT EXTENSIBLES ET LEUR
PROCEDE DE FABRICATION
 (54) Title: RADIALLY EXPANDABLE TUBULAR POLYTETRAFLUOROETHYLENE GRAFTS AND METHOD OF MAKING
SAME



(57) **Abrégé/Abstract:**

Tubular ePTFE materials which are capable of being radially expanded under the influence of a radially outward force applied from the lumen of the ePTFE tubular material to substantially uniformly radially deform the ePTFE material. The ePTFE material is radially expandable to a diameter 700 % its unexpanded diameter under the influence of pressures less than 6 atm while retaining the structural integrity of the ePTFE microstructure. Conservation of the structural integrity of the ePTFE material is determined by conservation of the ePTFE microstructure structural integrity.

PCT

WORLD INTELLECTUAL PROPERTY ORGANIZATION
International Bureau

INTERNATIONAL APPLICATION PUBLISHED UNDER THE PATENT COOPERATION TREATY (PCT)

<p>(51) International Patent Classification⁶ : A61F 2/06</p>	<p>A3</p>	<p>(11) International Publication Number: WO 98/33453</p> <p>(43) International Publication Date: 6 August 1998 (06.08.98)</p>
<p>(21) International Application Number: PCT/US98/02361</p> <p>(22) International Filing Date: 2 February 1998 (02.02.98)</p> <p>(30) Priority Data: 08/794,871 5 February 1997 (05.02.97) US</p> <p>(71) Applicant: IMPRA, INC. [US/US]; 1625 West Third Street, P.O. Box 1740, Tempe, AZ 85280-1740 (US).</p> <p>(74) Agent: ROSENBAUM, David, G.; Sonnenschein, Nath & Rosenthal, 8000 Sears Tower, 233 South Wacker Drive, Chicago, IL 60606-6404 (US).</p>	<p>(81) Designated States: AU, CA, JP, European patent (AT, BE, CH, DE, DK, ES, FI, FR, GB, GR, IE, IT, LU, MC, NL, PT, SE).</p> <p>Published <i>With international search report. Before the expiration of the time limit for amending the claims and to be republished in the event of the receipt of amendments.</i></p> <p>(88) Date of publication of the international search report: 17 September 1998 (17.09.98)</p>	

(54) Title: RADIALLY EXPANDABLE TUBULAR POLYTETRAFLUOROETHYLENE GRAFTS AND METHOD OF MAKING SAME

(57) Abstract

Tubular ePTFE materials which are capable of being radially expanded under the influence of a radially outward force applied from the lumen of the ePTFE tubular material to substantially uniformly radially deform the ePTFE material. The ePTFE material is radially expandable to a diameter 700 % its unexpanded diameter under the influence of pressures less than 6 atm while retaining the structural integrity of the ePTFE microstructure. Conservation of the structural integrity of the ePTFE material is determined by conservation of the ePTFE microstructure structural integrity.

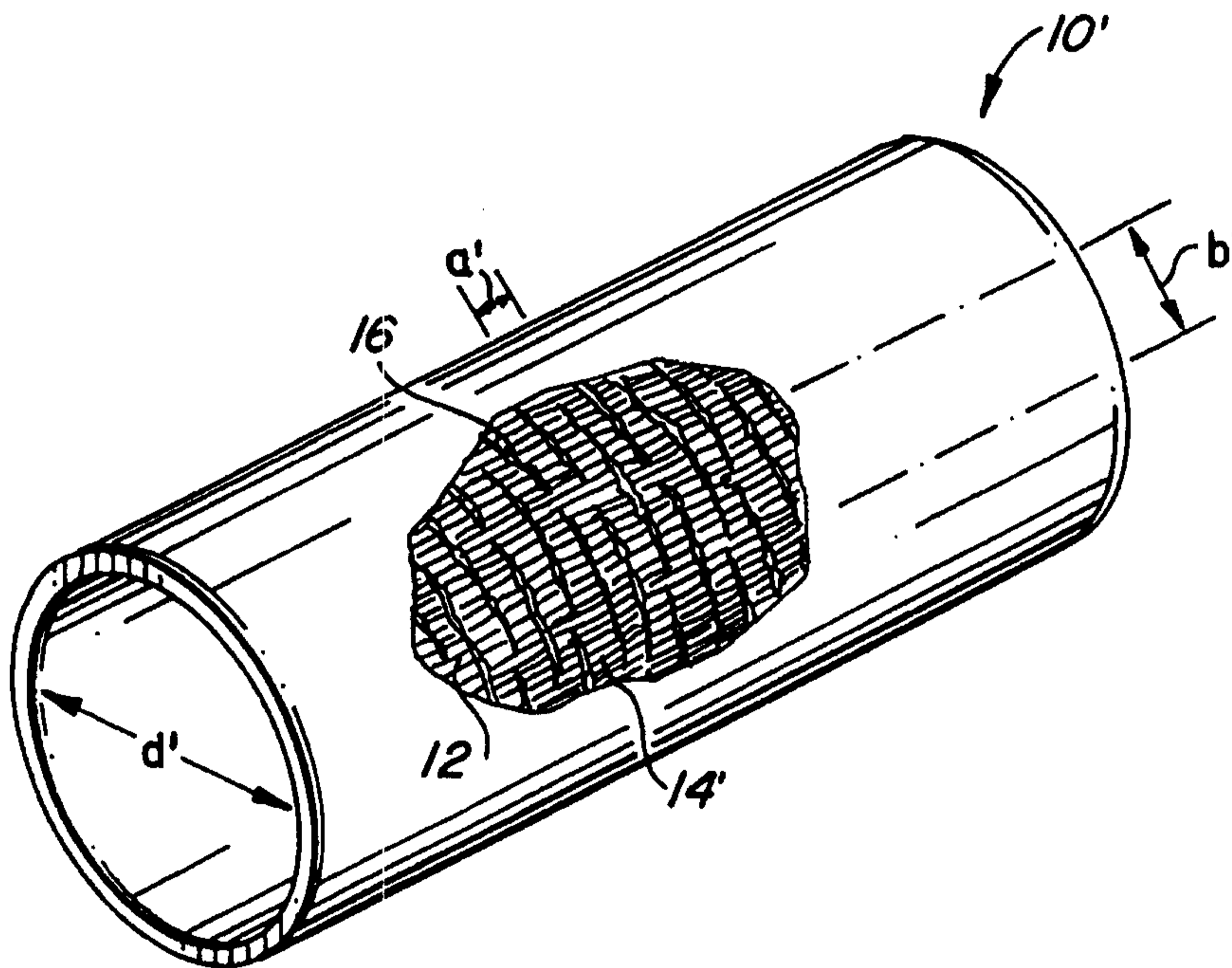

RADIALLY EXPANDABLE TUBULAR POLYTETRAFLUOROETHYLENE GRAFTS AND METHOD OF MAKING SAME

Background of the Invention

The present invention relates generally to longitudinally expanded microporous tubular polytetrafluoroethylene grafts, and more particularly, to radially expandable polytetrafluoroethylene ("rePTFE") grafts which are longitudinally expanded and sintered prior to radial expansion. The radially expandable polytetrafluoroethylene grafts of the present invention are particularly well suited for covering an endoluminal prosthesis, being endoluminally delivered to a site within a mammalian body, and radially expanded *in vivo* to restore an anatomical passageway or to create a passageway.

Microporous expanded polytetrafluoroethylene ("ePTFE") tubes may be made by any one of different, but well known, methods. Expanded polytetrafluoroethylene is typically made by admixing particulate dry polytetrafluoroethylene resin with a lubricant to form a viscous slurry. The admixture is poured into a mold, typically a cylindrical mold, and compressed under the influence of a positive pressure to form a cylindrical billet. The billet is then ram extruded through an extrusion die into either tubular or sheet structures termed in the art as extrudates. The extrudates consist of extruded polytetrafluoroethylene-lubricant admixture, termed in the art as "wet PTFE." Wet PTFE has a microstructure of coalesced, coherent PTFE resin particles in a highly crystalline state. After extrusion, the wet PTFE is exposed to a temperature below the flash point of the lubricant to volatilize a major fraction of the lubricant from the PTFE extrudate. The resulting PTFE extrudate without a major fraction of lubricant is known in the art as dried PTFE. The dried PTFE is then either uniaxially, biaxially or radially expanded using appropriate mechanical apparatus known in the art. Expansion is typically carried out at an elevated temperature, *e.g.*, above room temperature but below 327 °C, the crystalline melt point of polytetrafluoroethylene. Uniaxial, biaxial or radial expansion of the dried PTFE causes the coalesced, coherent PTFE resin to form fibrils emanating from nodes, with the fibrils oriented parallel to the axis of expansion. Once expanded, the dried PTFE is referred to as expanded PTFE ("ePTFE")

or microporous PTFE. The ePTFE is then transferred to a heating oven and heated to a temperature above 327 °C, the crystalline melt point of PTFE, while restraining the ePTFE against uniaxial, biaxial radial contraction, to sinter the ePTFE, thereby causing at least a portion of the crystalline PTFE to undergo a physical change from a crystalline structure to an amorphous structure. The conversion from a highly crystalline structure to an increased amorphous content, which results from sintering, serves to lock the node and fibril microstructure, as well as its orientation relative to the axis of expansion, and provides a dimensionally stable tubular or sheet material upon cooling. Expansion may also be carried out at a temperature below the vapor point of the lubricant. However, prior to the sintering step, the PTFE must be dried of lubricant because the sintering temperature of PTFE is greater than the flash point of commercially available lubricants.

Sintered ePTFE articles exhibit significant resistance to further uniaxial, or radial expansion. This property has lead many in the art to devise techniques which entail endoluminal delivery and placement of an ePTFE graft having a desired fixed diameter, followed by endoluminal delivery and placement of an endoluminal prosthesis, such as a stent or other fixation device, to frictionally engage the endoluminal prosthesis within the lumen of the anatomical passageway. The Kreamer Patent, U.S. Patent No. 5,078,726, issued in 1992, exemplifies such use of an ePTFE prosthetic graft. Kreamer discloses a method of excluding an abdominal aortic aneurysm which entails providing a tubular PTFE graft which has a diameter corresponding to that of the inside diameter of a healthy section of the abdominal aorta, delivering the tubular PTFE graft and positioning the graft so that it spans the abdominal aorta. Prosthetic balloon expandable stents are then delivered and placed proximal and distal the abdominal aorta and within the lumen of the tubular PTFE graft. The prosthetic stents are then balloon expanded to frictionally engage the proximal and distal ends of the tubular PTFE graft against the inner luminal wall of healthy sections of the abdominal aorta.

Similarly, published International Applications No. WO95/05132 and WO95/05555, both published 23 February 1995, filed by W.L. Gore Associates, Inc., disclose balloon expandable prosthetic stents which have been covered on inner and outer surfaces of the

stent by wrapping ePTFE sheet material about the balloon expandable prosthetic stent in its enlarged diameter, sintering the wrapped ePTFE sheet material to secure it about the stent, then the assembly is crimped down to a reduced diameter for endoluminal delivery using a balloon catheter. Once positioned endoluminally, the stent-graft combination is then
5 dilatated to re-expand the stent to its enlarged diameter and return the ePTFE wrapping to its original diameter. Thus, the original unexpanded diameter of the ePTFE wrap delimits diametric expansion of the stent and the ePTFE wrap is returned to its original uncrimped diameter.

Thus, it is well known in the prior art to provide an ePTFE covering which is
10 fabricated at the final desired endovascular diameter and is endoluminally delivered in a folded or crimped condition to reduce its delivery profile, then unfolded *in vivo* using either the spring tension of a self-expanding, thermally induced, expanding structural support member or a balloon catheter.

In contradistinction to the prior art, the present invention provides a radially,
15 plastically deformable tubular ePTFE material, having a microstructure of nodes interconnected by fibrils, with the nodes being substantially perpendicular to the longitudinal axis of the tubular ePTFE material and the fibrils being oriented parallel to the longitudinal axis of the tubular ePTFE material. Radial expansion of the inventive ePTFE material deforms the ePTFE microstructure by elongating the nodes while substantially retaining the
20 internodal distances (IND) between adjacent nodes in the longitudinal axis of the ePTFE tube.

As used herein, the following terms have the intended meanings as indicated.

"Fibril" refers to a strand of PTFE material which originates from one or more nodes and terminates at one or more nodes."

25 "Internodal Distance" or "IND" refers to an average distance between two adjacent nodes measured along the longitudinal axis of each node between the facing surfaces of the adjacent nodes. IND is expressed in microns (μ) as the unit of measure.

"Node" refers to the solid region within an ePTFE material at which fibrils originate and converge.

"Node Length" as used herein refers to a distance measured along a straight line between the furthestmost opposing end points of a single node.

5 "Nodal Elongation" as used herein refers to expansion of PTFE nodes in the ePTFE microstructure along the longitudinal axis of a node, or along the Node Length.

"Node Width" as used herein refers to a distance measured along a straight line drawn perpendicular to the longitudinal axis of a node between opposing longitudinal surfaces of a node.

10 "Plastic Deformation" as used herein refers to the radial deformation of the ePTFE microstructure under the influence of a radially expansive force which deforms and elongates the Node Length and results in elastic recoil of the ePTFE material less than about 25%.

15 "Radially Expandable" as used herein to describe the present invention refers to a property of the ePTFE tubular member to undergo radially-oriented Plastic Deformation mediated by Nodal Elongation.

20 "Structural Integrity" as used herein to describe the present invention refers to a condition of the ePTFE microstructure both pre and post-radial deformation in which the fibrils are substantially free of fractures or breaks and the ePTFE material is free of gross failures.

The inventive ePTFE material of the present invention is capable of being radially expanded under the influence of a radially outward force applied from the lumen of the ePTFE tubular material to substantially uniformly deform the ePTFE material. The inventive ePTFE material is radially expandable to a diameter 700% its unexpanded

diameter under the influence of pressures less than 6 atm, preferably less than or equal to about 4.0 to 4.5 atm., most preferably between 2-3 atm., while retaining the structural integrity of the ePTFE microstructure. Conservation of the structural integrity of the ePTFE material is determined by conservation of the ePTFE microstructure structural integrity. During and after radial expansion up to an including about 700% of the original unexpanded diameter, the ePTFE microstructure structural integrity is considered conserved where the following factors are met: 1) IND remains substantially the same as the unexpanded graft; 2) water entry pressure as measured by Association for the Advancement of Medical Instrumentation (AAMI) test method 8.2.4 remains within $\pm 60\%$ of the water entry pressure of the unexpanded graft; 3) the wall thickness of the graft, as determined by AAMI test method 8.7.4, maintains its concentricity as determined by a substantially uniform wall thickness within $\pm 30\%$ about the circumference of the graft; 4) average post-radial expansion wall thickness remains within about $\pm 70\%$ of the average pre-radial expansion wall thickness as determined by AAMI test method 8.7.4; 5) longitudinal tensile strength as measured by AAMI test method 8.3.2 remains within $\pm 100\%$ of the value of the unexpanded graft, when normalized for wall thickness; 6) radial tensile strength as measured by AAMI test method 8.3.1 remains within $\pm 40\%$ of the value of the unexpanded graft, when normalized for wall thickness; and 7) is free of gross tears or fractures.

Summary of the Invention

It is a primary objective of the present invention to provide an ePTFE tubular member which is radially expandable *in vivo* at radial expansion pressures less than about 6 atm. and is suitable for use as a cover or liner for an endoluminal support member, such as a self-expanding stent, shape memory stent, or balloon expandable stent.

It is another primary objective of the present invention to provide an ePTFE tubular member which is capable of being delivered intraluminally into the body in a relatively small diameter and radially expanded *in vivo* to act as an intraluminal anatomical liner of, for

example, the vasculature, the alimentary tract, biliary ducts, hepatic-portal vein shunts, or as bypass grafts to carry body fluids around an obstructed flow path.

It is another objective of the present invention to provide a radially expandable ePTFE tubular member which is capable of percutaneous and endovascular delivery to both
5 the coronary and peripheral vasculature in a mammalian body.

It is still another objective of the present invention to provide a radially expandable ePTFE tubular member which, after radial expansion up to about 700% its original diameter, retains its structural integrity.

It is yet another objective of the present invention to provide a radially expandable
10 ePTFE tubular member which, after radial expansion up to about 700% its original diameter, retains the structural integrity of the ePTFE microstructure.

It is still yet another objective of the present invention to provide a radially expandable ePTFE tubular member which, after radial expansion up to about 700% its original diameter, is characterized by 1) IND remains substantially the same as the
15 unexpanded graft; 2) water entry pressure as measured by Association for the Advancement of Medical Instrumentation (AAMI) test method 8.2.4 remains within $\pm 60\%$ of the water entry pressure of the unexpanded graft; 3) the wall thickness of the graft, as determined by AAMI test method 8.7.4, maintains its concentricity as determined by a substantially uniform wall thickness within $\pm 30\%$ about the circumference of the graft; 4) average post-
20 radial expansion wall thickness remains within about $\pm 70\%$ of the average pre-radial expansion wall thickness as determined by AAMI test method 8.7.4; 5) longitudinal tensile strength as measured by AAMI test method 8.3.2 remains within $\pm 100\%$ of the value of the unexpanded graft, when normalized for wall thickness; 6) radial tensile strength as measured by AAMI test method 8.3.1 remains within $\pm 40\%$ of the value of the unexpanded graft,
25 when normalized for wall thickness; and 7) is free of gross tears or fractures.

It is another primary objective of the present invention to provide a method of making a ePTFE tubular member which is radially expandable *in vivo* at radial expansion pressures less than about 6 atm. and is suitable for use as a cover or liner for an endoluminal support member, such as a self-expanding, shape memory, or balloon expandable stent, and which is characterized by any of the foregoing objectives for the radially expandable ePTFE tubular member.

Brief Description of the Drawings

Figure 1 is a perspective, partial cut-away view of a radially expandable ePTFE graft in accordance with the present invention diagrammatically illustrating the pre-radially expansion microstructure of the ePTFE material.

Figure 2 is a perspective, partial cut-away view of the inventive radially expandable ePTFE graft in its post-expansion diameter diagrammatically illustrating the post-radial expansion microstructure of the ePTFE material.

Figure 3A is a longitudinal cross-sectional view depicting the inventive radially expandable ePTFE graft covering a radially expandable endoluminal stent, the assembly being depicted mounted on a balloon catheter in its radially unexpanded condition.

Figure 3B is the longitudinal cross-sectional view depicting the inventive radially expandable ePTFE graft covering a radially expandable endoluminal stent, the assembly being depicted mounted on a balloon catheter in its radially expanded condition.

Figure 4 is a process flow diagram illustrating the inventive method for making radially expandable polytetrafluoroethylene tubes.

Figure 5A is a scanning electron photomicrograph of the inner surface of a 3 mm ID conventional non-radially expanded ePTFE vascular graft at 200X magnification.

Figure 5B is a scanning electron photomicrograph of the inner surface of the 3 mm ID conventional non-radially expanded ePTFE vascular graft of Figure 5A taken at 500X magnification.

5 Figure 5C is a scanning electron photomicrograph of the outer surface of the 3 mm ID conventional non-radially expanded ePTFE vascular graft of Figure 5A at 200X magnification.

Figure 5D is a scanning electron photomicrograph of the outer surface of the 3 mm ID conventional non-radially expanded ePTFE vascular graft of Figure 6A taken at 500X magnification.

10 Figure 6A is a scanning electron photomicrograph of the inner surface of a 3 mm ID conventional expanded ePTFE vascular graft radially expanded 3X at 200X magnification.

Figure 6B is a scanning electron photomicrograph of the inner surface of the 3 mm ID conventional expanded ePTFE vascular graft of Figure 6A taken at 500X magnification.

15 Figure 6C is a scanning electron photomicrograph of the outer surface of the 3 mm ID conventional expanded ePTFE vascular graft of Figure 6A at 200X magnification.

Figure 6D is a scanning electron photomicrograph of the outer surface of the 3 mm ID conventional expanded ePTFE vascular graft of Figure 6A taken at 500X magnification.

Figure 7A is a scanning electron photomicrograph of the inner surface of a 3 mm ID conventional expanded ePTFE vascular graft radially expanded 4X at 200X magnification.

20 Figure 7B is a scanning electron photomicrograph of the inner surface of the 3 mm ID conventional expanded ePTFE vascular graft of Figure 7A taken at 500X magnification.

Figure 7C is a scanning electron photomicrograph of the outer surface of the 3 mm ID conventional expanded ePTFE vascular graft of Figure 7A at 200X magnification.

Figure 7D is a scanning electron photomicrograph of the outer surface of the 3 mm ID conventional expanded ePTFE vascular graft of Figure 7A taken at 500X magnification.

5 Figure 8A is a scanning electron photomicrograph of the inner surface of a 3 mm ID conventional expanded ePTFE vascular graft radially expanded 5X at 200X magnification.

Figure 8B is a scanning electron photomicrograph of the inner surface of the 3 mm ID conventional expanded ePTFE vascular graft of Figure 8A taken at 500X magnification.

10 Figure 8C is a scanning electron photomicrograph of the outer surface of the 3 mm ID conventional expanded ePTFE vascular graft of Figure 8A at 200X magnification.

Figure 8D is a scanning electron photomicrograph of the outer surface of the 3 mm ID conventional expanded ePTFE vascular graft of Figure 8A taken at 500X magnification.

Figure 9A is a scanning electron photomicrograph of the inner surface of a 6 mm ID conventional non-radially expanded ePTFE vascular graft at 200X magnification.

15 Figure 9B is a scanning electron photomicrograph of the inner surface of the 6 mm ID conventional non-radially expanded ePTFE vascular graft of Figure 9A taken at 500X magnification.

20 Figure 9C is a scanning electron photomicrograph of the outer surface of the 6 mm ID conventional non-radially expanded ePTFE vascular graft of Figure 9A at 200X magnification.

Figure 9D is a scanning electron photomicrograph of the outer surface of the 6 mm ID conventional non-radially expanded ePTFE vascular graft of Figure 9A taken at 500X magnification.

5 Figure 10A is a scanning electron photomicrograph of the inner surface of a 6 mm ID conventional expanded ePTFE vascular graft radially expanded 3X at 200X magnification.

Figure 10B is a scanning electron photomicrograph of the inner surface of the 6 mm ID conventional expanded ePTFE vascular graft of Figure 10A taken at 500X magnification.

10 Figure 10C is a scanning electron photomicrograph of the outer surface of the 6 mm ID conventional expanded ePTFE vascular graft of Figure 10A at 200X magnification.

Figure 10D is a scanning electron photomicrograph of the outer surface of the 6 mm ID conventional expanded ePTFE vascular graft of Figure 10A taken at 500X magnification.

15 Figure 11A is a scanning electron photomicrograph of the inner surface of a 6 mm ID conventional expanded ePTFE vascular graft radially expanded 4X at 200X magnification.

20 Figure 11B is a scanning electron photomicrograph of the inner surface of the 6 mm ID conventional expanded ePTFE vascular graft of Figure 11A taken at 500X magnification.

Figure 11C is a scanning electron photomicrograph of the outer surface of the 6 mm ID conventional expanded ePTFE vascular graft of Figure 11A at 200X magnification.

Figure 11D is a scanning electron photomicrograph of the outer surface of the 6 mm ID conventional expanded ePTFE vascular graft of Figure 11A taken at 500X magnification.

5 Figure 12A is a scanning electron photomicrograph of the inner surface of a 6 mm ID conventional expanded ePTFE vascular graft radially expanded 5X at 200X magnification.

Figure 12B is a scanning electron photomicrograph of the inner surface of the 6 mm ID conventional expanded ePTFE vascular graft of Figure 12A taken at 500X magnification.

10 Figure 12C is a scanning electron photomicrograph of the outer surface of the 6 mm ID conventional expanded ePTFE vascular graft of Figure 12A at 200X magnification.

Figure 12D is a scanning electron photomicrograph of the outer surface of the 6 mm ID conventional expanded ePTFE vascular graft of Figure 12A taken at 500X magnification.

15 Figure 13A is a scanning electron photomicrograph of the inner surface of a non-radially expanded 3 mm ID inventive rePTFE endoluminal graft ERF 1683 at 200X magnification.

20 Figure 13B is a scanning electron photomicrograph of the inner surface of the non-radially expanded 3 mm ID inventive rePTFE endoluminal graft of Figure 13A taken at 500X magnification.

Figure 13C is a scanning electron photomicrograph of the outer surface of the non-radially expanded 3 mm ID inventive rePTFE endoluminal graft of Figure 13A at 200X magnification.

Figure 13D is a scanning electron photomicrograph of the outer surface of the non-radially expanded 3 mm ID inventive rePTFE endoluminal graft of Figure 13A taken at 500X magnification.

5 Figure 14A is a scanning electron photomicrograph of the inner surface of an inventive rePTFE endoluminal graft ERF 1683 radially expanded 3X at 200X magnification.

Figure 14B is a scanning electron photomicrograph of the inner surface of the inventive rePTFE endoluminal graft ERF 1683 of Figure 14A taken at 500X magnification.

Figure 14C is a scanning electron photomicrograph of the outer surface of the inventive rePTFE endoluminal graft ERF 1683 of Figure 14A at 200X magnification.

10 Figure 14D is a scanning electron photomicrograph of the outer surface of the inventive rePTFE endoluminal graft ERF 1683 of Figure 14A taken at 500X magnification.

Figure 15A is a scanning electron photomicrograph of the inner surface of an inventive rePTFE endoluminal graft ERF 1683 radially expanded 4X at 200X magnification.

15 Figure 15B is a scanning electron photomicrograph of the inner surface of the inventive rePTFE endoluminal graft ERF 1683 of Figure 15A taken at 500X magnification.

Figure 15C is a scanning electron photomicrograph of the outer surface of the inventive rePTFE endoluminal graft ERF 1683 of Figure 15A at 200X magnification.

Figure 15D is a scanning electron photomicrograph of the outer surface of the inventive rePTFE endoluminal graft ERF 1683 of Figure 15A taken at 500X magnification.

20 Figure 16A is a scanning electron photomicrograph of the inner surface of an inventive rePTFE endoluminal graft ERF 1683 radially expanded 5X at 200X magnification.

Figure 16B is a scanning electron photomicrograph of the inner surface of the inventive rePTFE endoluminal graft ERF 1683 of Figure 16A taken at 500X magnification.

Figure 16C is a scanning electron photomicrograph of the outer surface of the inventive rePTFE endoluminal graft ERF 1683 of Figure 16A at 200X magnification.

5 Figure 16D is a scanning electron photomicrograph of the outer surface of the inventive rePTFE endoluminal graft ERF 1683 of Figure 16A taken at 500X magnification.

Figure 17A is a scanning electron photomicrograph of the inner surface of a non-radially expanded 3 mm ID inventive rePTFE endoluminal graft ERF 1687 at 200X magnification.

10 Figure 17B is a scanning electron photomicrograph of the inner surface of the non-radially expanded 3 mm ID inventive rePTFE endoluminal graft of Figure 17A taken at 500X magnification.

15 Figure 17C is a scanning electron photomicrograph of the outer surface of the non-radially expanded 3 mm ID inventive rePTFE endoluminal graft of Figure 17A at 200X magnification.

Figure 17D is a scanning electron photomicrograph of the outer surface of the non-radially expanded 3 mm ID inventive rePTFE endoluminal graft of Figure 17A taken at 500X magnification.

20 Figure 18A is a scanning electron photomicrograph of the inner surface of an inventive rePTFE endoluminal graft ERF 1687 radially expanded 3X at 200X magnification.

Figure 18B is a scanning electron photomicrograph of the inner surface of the inventive rePTFE endoluminal graft ERF 1687 of Figure 18A taken at 500X magnification.

Figure 18C is a scanning electron photomicrograph of the outer surface of the inventive rePTFE endoluminal graft ERF 1687 of Figure 18A at 200X magnification.

Figure 18D is a scanning electron photomicrograph of the outer surface of the inventive rePTFE endoluminal graft ERF 1687 of Figure 18A taken at 500X magnification.

5 Figure 19A is a scanning electron photomicrograph of the inner surface of an inventive rePTFE endoluminal graft ERF 1687 radially expanded 4X at 200X magnification.

Figure 19B is a scanning electron photomicrograph of the inner surface of the inventive rePTFE endoluminal graft ERF 1687 of Figure 19A taken at 500X magnification.

10 Figure 19C is a scanning electron photomicrograph of the outer surface of the inventive rePTFE endoluminal graft ERF 1687 of Figure 19A at 200X magnification.

Figure 19D is a scanning electron photomicrograph of the outer surface of the inventive rePTFE endoluminal graft ERF 1687 of Figure 19A taken at 500X magnification.

Figure 20A is a scanning electron photomicrograph of the inner surface of an inventive rePTFE endoluminal graft ERF 1687 radially expanded 5X at 200X magnification.

15 Figure 20B is a scanning electron photomicrograph of the inner surface of the inventive rePTFE endoluminal graft ERF 1687 of Figure 20A taken at 500X magnification.

Figure 20C is a scanning electron photomicrograph of the outer surface of the inventive rePTFE endoluminal graft ERF 1687 of Figure 20A at 200X magnification.

20 Figure 20D is a scanning electron photomicrograph of the outer surface of the inventive rePTFE endoluminal graft ERF 1687 of Figure 20A taken at 500X magnification.

Figure 21A is a scanning electron photomicrograph of the inner surface of a non-radially expanded 3 mm ID inventive rePTFE endoluminal graft ERF 1689 at 200X magnification.

5 Figure 21B is a scanning electron photomicrograph of the inner surface of the non-radially expanded 3 mm ID inventive rePTFE endoluminal graft of Figure 21A taken at 500X magnification.

Figure 21C is a scanning electron photomicrograph of the outer surface of the non-radially expanded 3 mm ID inventive rePTFE endoluminal graft of Figure 21A at 200X magnification.

10 Figure 21D is a scanning electron photomicrograph of the outer surface of the non-radially expanded 3 mm ID inventive rePTFE endoluminal graft of Figure 21A taken at 500X magnification.

Figure 22A is a scanning electron photomicrograph of the inner surface of an inventive rePTFE endoluminal graft ERF 1689 radially expanded 3X at 200X magnification.

15 Figure 22B is a scanning electron photomicrograph of the inner surface of the inventive rePTFE endoluminal graft ERF 1689 of Figure 22A taken at 500X magnification.

Figure 22C is a scanning electron photomicrograph of the outer surface of the inventive rePTFE endoluminal graft ERF 1689 of Figure 22A at 200X magnification.

20 Figure 22D is a scanning electron photomicrograph of the outer surface of the inventive rePTFE endoluminal graft ERF 1689 of Figure 22A taken at 500X magnification.

Figure 23A is a scanning electron photomicrograph of the inner surface of an inventive rePTFE endoluminal graft ERF 1689 radially expanded 4X at 200X magnification.

Figure 23B is a scanning electron photomicrograph of the inner surface of the inventive rePTFE endoluminal graft ERF 1689 of Figure 23A taken at 500X magnification.

Figure 23C is a scanning electron photomicrograph of the outer surface of the inventive rePTFE endoluminal graft ERF 1689 of Figure 23A at 200X magnification.

5 Figure 23D is a scanning electron photomicrograph of the outer surface of the inventive rePTFE endoluminal graft ERF 1689 of Figure 23A taken at 500X magnification.

Figure 24A is a scanning electron photomicrograph of the inner surface of an inventive rePTFE endoluminal graft ERF 1689 radially expanded 5X at 200X magnification.

10 Figure 24B is a scanning electron photomicrograph of the inner surface of the inventive rePTFE endoluminal graft ERF 1689 of Figure 24A taken at 500X magnification.

Figure 24C is a scanning electron photomicrograph of the outer surface of the inventive rePTFE endoluminal graft ERF 1689 of Figure 24A at 200X magnification.

15 Figure 24D is a scanning electron photomicrograph of the outer surface of the inventive rePTFE endoluminal graft ERF 1689 of Figure 24A taken at 500X magnification.

Detailed Description of the Preferred Embodiments

In accordance with the preferred embodiments of the present invention there is provided a longitudinally expanded polytetrafluoroethylene tubular member having a continuous substantially concentric wall surface which has no seam and which is radially
20 deformable between about 50% to about 700% its original diameter with application of a radially directed outward pressure of less than about 6 atm, preferably less than or equal to about 4 to 4.5 atm without loss of structural integrity. Structural integrity is considered retained where the microstructure of the ePTFE after radial expansion, is substantially free

of broken or fractured fibrils and where the following factors are met: 1) IND remains substantially the same as the unexpanded graft; 2) water entry pressure as measured by Association for the Advancement of Medical Instrumentation (AAMI) test method 8.2.4 remains within $\pm 60\%$ of the water entry pressure of the unexpanded graft; 3) the wall thickness of the graft, as determined by AAMI test method 8.7.4, maintains its concentricity as determined by a substantially uniform wall thickness within $\pm 30\%$ about the circumference of the graft; 4) average post-radial expansion wall thickness remains within about $\pm 70\%$ of the average pre-radial expansion wall thickness as determined by AAMI test method 8.7.4; 5) longitudinal tensile strength as measured by AAMI test method 8.3.2 remains within $\pm 100\%$ of the value of the unexpanded graft, when normalized for wall thickness; 6) radial tensile strength as measured by AAMI test method 8.3.1 remains within $\pm 40\%$ of the value of the unexpanded graft, when normalized for wall thickness; and 7) is free of gross tears or fractures.

As is well known in the art, longitudinally expanded polytetrafluoroethylene (ePTFE) tubular structures may be made by ram extruding a compressed billet of polytetrafluoroethylene resin and a lubricant extrusion aid through an annular orifice formed by an extrusion die and a mandrel to form a tubular extrudate. The tubular extrudate is free of seams, overlaps, crimps, folds, or the like. While the tubular extrudate still contains the lubricant it is referred to as being "wet." The wet extrudate lacks dimensional stability, is easily damaged, and is difficult to manipulate or otherwise process without removing the lubricant. Typically lubricant is removed and the extrudate "dried" by heating the wet extrudate to a temperature below the flash point of the lubricant and below the crystalline melt temperature of the PTFE resin which volatilizes the lubricant from the PTFE resin. Dimensional stability and the degree to which the extrudate may be manipulated or processed is related to the concentration of lubricant in the extrudate. Thus, the extrudate may be partially or fully dried, depending upon the residual lubricant concentration desired, by varying the dwell or residence time of the wet extrudate in the drying oven.

Once the extrudate is dried to the extent desired, the dried extrudate is longitudinally expanded at a temperature below the crystalline melt temperature of the PTFE resin.

Longitudinal expansion is performed at a rate of between about 5%/sec. to about 800%/sec. with the final expansion ratio being between 2:1 to 6:1. The ends of the longitudinally expanded PTFE are constrained against shortening and the ePTFE is exposed to a temperature above the crystalline melt temperature of the PTFE resin for a period of time to sinter the PTFE and amorphously lock the node-fibril microstructure and stabilize the porosity of the ePTFE tubular structure.

Figure 1 depicts a radially expandable ePTFE tubular member 10 in accordance with the present invention. The inventive ePTFE tubular member 10 has an inner diameter d and is shown with a portion of its outer surface cut away and microscopically enlarged to illustrate the ePTFE microstructure 12. The ePTFE microstructure consists of a plurality of nodes 14 interconnected by a plurality of fibrils 16. The plurality of fibrils 16 emanate from and converge to the plurality of nodes 14 spanning the internodal distance a . The plurality of nodes 14 are each substantially solid, have a node length b which is generally perpendicular to the longitudinal axis of the ePTFE tubular member 10 and parallel with the transverse axis of the ePTFE tubular member 10.

Figure 2 depicts the same tube depicted in Figure 1 which has been radially expanded to a larger diameter d' . Radial expansion is accomplished, for example, by introducing a balloon catheter into the lumen of the ePTFE tubular member 10, introducing a pressurized fluid into the balloon catheter, thereby causing the catheter balloon to expand and exert a positive pressure directed radially outward from the lumen of ePTFE tubular member 10, which, in turn, radially deforms ePTFE tubular member 10 to a larger diameter. Radial deformation of the ePTFE tubular member 10 is mediated by elongation of the plurality of nodes 14 to an elongated node length b' in the region of the ePTFE tubular member 10 where the positive pressure is exerted by the catheter balloon. As illustrated in Figure 2 the entire ePTFE tubular member 10 is radially deformed to the larger diameter d' . One notable physical feature of the present invention is the elongation of the plurality of nodes 14 along their longitudinal axis while the post-expansion average internodal distances a' remains substantially the same as the internodal distance a of the non-radially deformed ePTFE tubular member 10.

It will be understood, by those skilled in the art, that the radially deformable ePTFE tubular member 10 of the present invention is particularly well suited for use as a covering or liner for an endoluminal stent. Endoluminal stents are generally of three types. Balloon expandable endoluminal stents require the application of a positive pressure to the stent to radially deform the stent beyond the elastic limit of the material used to make the stent. Balloon expandable stents are represented in the art by PALMAZ patents. Self-expanding endoluminal stents are made with a configuration which takes advantage of the elastic properties of the stent material and are radially constrained by a restraining sheath during endoluminal delivery and undergo elastic expansion to their unconstrained diameter when the restraining sheath is removed. Self expanding stents are represented in the art by the GIANTURCO or WALLSTENT. Finally, shape memory stents are made of shape memory materials, such as nickel-titanium alloys known as NITINOL, which expand upon exposure to a temperature differential, e.g., expands at body temperature. Any of the foregoing endoluminal stent types may be covered, lined or encapsulated by the inventive radially deformable ePTFE tubular member 10 and radially expanded either *in vivo* or *in vitro*.

Figures 3A and 3B illustrate the inventive radially expandable ePTFE material 10 encapsulating an endoluminal stent 20, as more fully described in commonly assigned, co-pending application published as PCT International Application WO96/28115, published 19 September, 1996, claiming priority from U.S. Patent Nos. 5,749,880 and 6,124,523.

20

Figure 3A illustrates an encapsulated stent graft 20 in its pre-radially expanded diameter, while Figure 3B illustrates an encapsulated stent graft 30 in its post-radially expanded diameter. The encapsulated stent graft assembly, consisting generally of radially expandable ePTFE material 10 and endoluminal stent 20, are concentrically positioned about a catheter balloon 34 mounted on the distal end of a balloon catheter 32. The catheter balloon 34 defines an inflation chamber 36 therein which receives a pressurized inflation fluid (not shown) from an external source (not shown). When the pressurized inflation fluid is introduced into the inflation chamber 36, an outwardly directed radial force is exerted substantially uniformly against the luminal surface of the stent graft assembly, thereby urging the stent-graft assembly from its smaller delivery diameter to a

30

larger final diameter depicted in Figure 3B. During dilatation of the catheter balloon 34, the rePTFE material 10 undergoes a substantially plastic deformation transverse to the longitudinal axis of the tubular ePTFE material 10. The positive pressure exerted by the pressurized inflation fluid exerts a radially outward positive pressure to the luminal surface of the radially deformable ePTFE which is oriented substantially parallel to the longitudinal axis of the plurality of nodes in the ePTFE microstructure. The plurality of nodes in the ePTFE microstructure undergo substantially plastic deformation and elongate along their longitudinal axis, thus causing the radial deformation of the ePTFE tubular material 10.

Figures 5A-5D are scanning electron micrographs taken at 200X and 500X magnification of the inner and outer surfaces of a standard ePTFE vascular graft (Lot 34391, IMPRA, Inc., Tempe, Arizona). It will be noted that the node-fibril microstructure of the ePTFE is characterized by irregular node patterns and fibrils which are substantially cylindrical as reflected by the substantially parallel surfaces along the longitudinal axis of each fibril.

Figures 6A-6D are scanning electron micrographs taken at 200 and 500X magnification of the inner and outer surfaces of the standard ePTFE vascular graft of Figures 5A-5D which has been radially expanded 3X to an inner diameter of 9 mm. Figures 7A-7D are scanning electron micrographs of the inner and outer surfaces of the standard ePTFE vascular graft of Figures 5A-5D which has been radially expanded 4X to an inner diameter of 12 mm. Figures 8A-8D are scanning electron micrographs of the inner and outer surfaces of the standard ePTFE vascular graft of Figures 5A-5D which has been radially expanded 4X to an inner diameter of 15 mm. From this series of micrographs, it will be observed that the nodes have a largely irregular elongate appearance and are asynchronously arrayed in the microstructure. While average outer surface internodal distance of the base graft is 33μ , at 3X is 33μ , at 4X is 32μ and at 5X is 33μ , the micrographs illustrate that the INDs have a non-uniform distribution throughout the material matrix. Morphologically, it will be seen that radial expansion of the conventional IMPRA ePTFE vascular graft results in elongation and thinning of the nodes, which remain irregular in shape, but the INDs continue to have a non-uniform distribution in the material

matrix. Figures 9A-D are micrographs of inner and outer surfaces of a non-radially expanded 6 mm ID PTFE graft (Lot No. 34396, IMPRA, Inc., Tempe, Arizona). Figures 10A-10B are scanning electron micrographs taken at 200 and 500X magnification of the inner and outer surfaces of the standard ePTFE vascular graft of Figures 9A-9D which has been radially expanded 3X to an inner diameter of 18 mm. Figures 11A-11D are scanning electron micrographs of the inner and outer surfaces of the standard ePTFE vascular graft of Figures 9A-9D which has been radially expanded 4X to an inner diameter of 24 mm. Figures 12A-12D are scanning electron micrographs of the inner and outer surfaces of the standard ePTFE vascular graft of Figures 9A-9D which has been radially expanded 5X to an inner diameter of 30mm. From this series of micrographs, it will be observed that, like the 3 mm standard PTFE graft, the nodes have a largely irregular elongate appearance and are asynchronously arrayed in the microstructure. While average outer surface internodal distance of the base graft is 33μ , at 3X is 31μ , at 4X is 33μ and at 5X is 33μ , the micrographs illustrate that the INDs have a non-uniform distribution throughout the material matrix. Morphologically, it will be seen that radial expansion of the conventional IMPRA ePTFE vascular graft results in elongation and thinning of the nodes, which remain irregular in shape, but the INDs continue to have a non-uniform distribution in the material matrix.

In contrast to the standard PTFE graft material, the inventive rePTFE material, represented herein by ERF 1683, ERF 1687 and ERF 1689, shown in their non-radially expanded base state, and at 3X, 4X and 5X radial expansion, in Figures 13A-24C, is characterized by a lower node density and lower fibril density in the unexpanded and expanded graft material. Scanning electron microscopy was performed on a JEOL-SM 840 Scanning Electron Microscope and the accompanying micrographs were obtained during scanning electron microscopy. The lower node density is the result of elongation of the nodes as the graft radially expands, while the lower fibril density is the result of increasing interfibril distances due to the nodal elongation. "Interfibril distance" is the perpendicular distance between any two parallel and adjacent fibrils. The nodes in the inventive rePTFE material are characterized by a more uniform regular elongate shape which, during radial expansion, undergo a more regular nodal elongation than that exhibited by the standard

PTFE graft material, and fibrils which have a torroidal or "necked" profile. Additionally, as reflected in the accompanying figures, the rePTFE microstructure is characterized by increased tortuosity of the pores than that exhibited by the standard PTFE graft material.

5 By an examination of the accompanying electron micrographs at Figures 13A-24C, it will be seen that the base unexpanded graft has average INDs of approximately 18.2μ . The plurality of fibrils have a generally torroidal shape along their longitudinal axis, with the intermediate area of each of the plurality of fibrils having a narrower width than the area at either end of the plurality of fibrils 16 adjacent the nodes which the fibrils connect. The plurality of nodes exhibit a substantially parallel array with the nodes being substantially co-axially aligned in end-to-end fashion along the transverse axis of the graft material.

10 The electron micrographs at Figures 14A-14D, 18A-18D, and 22A-22D, taken of ERF 1683, ERF 1687 and ERF 1689, respectively, radially expanded 3X, illustrate that at 3X expansion the INDs remain substantially the same as the unexpanded graft IND of Figures 13A-13D, 17A-17D and 21A-21D, respectively. Additionally, the plurality of nodes retain their co-axial array as in the unexpanded graft material, but are longitudinally deformed along their longitudinal axis and parallel to the axis of radial expansion. The longitudinal profile of the plurality of fibrils also remains generally torroidal in shape. It will be noted, however, that the profile of each of the plurality of nodes has been markedly altered, but in a non-linear manner relative to the degree of gross radial deformation of the ePTFE material itself. After radial deformation, each of the plurality of nodes 14 exhibits an elongated and narrowed profile. Starting at 3X expansion, it becomes apparent that the fibril density in the inventive rePTFE material is greater than that of the conventional ePTFE material and that the fibrils exhibit a more tangled or tortuous appearance than that found in the conventional ePTFE material.

25 The electron micrographs at Figures 15A-15D, 19A-19D and 23A-23D, taken of ERF 1683, ERF 1687 and ERF 1689, respectively, radially expanded 4X, illustrate that at 4X expansion the INDs remain substantially the same as the unexpanded graft IND of Figures 13A-13D, 17A-17D and 21A-21D, respectively. At 4X radial expansion the

increased tortuosity of the fibrils becomes even more apparent in the accompanying figures. While the interfibril distance continues to increase, the electron micrographs reflect that the each interfibrilar space is bounded in the z-axis by another fibril in close proximity to the interfibrilar space, which imparts the increased tortuosity of the rePTFE microstructure.

5 At 5X radial expansion, illustrated with reference to the electron micrographs at Figures 16A-16D, 20A-20D and 24A-24D, taken of taken of ERF 1683, ERF 1687 and ERF 1689, respectively, the interfibril distance has increased relative to both the base graft, or the rePTFE graft at 3X or 4X radial expansion, while the IND remains substantially the same as that of the base rePTFE graft or that at 3X or 4X radial expansion. Additionally,
10 the nodes have again elongated along the axis of radial expansion to form long, columnar nodes which have a generally regular distribution throughout the microstructure wherein a substantial majority of the nodes are separated by substantially uniform INDs.

 Radially deformable, longitudinally expanded PTFE tubular graft members meeting the criteria of the present invention are made by the method 50 for making radially
15 expandable PTFE tubes illustrated generally in Figure 4. In accordance with the inventive method the general method steps consist of providing a polytetrafluoroethylene resin 51 preferably having an average molecular weight about 120 Million and an average particle size between 350 and 750 μ , and an extrusion lubricant 52, such as ISOPAR H (Exxon Chemical), and admixing the PTFE resin and lubricant at step 53. It is preferable that the
20 lubricant be present in the admixture at a ratio of between about 13.5% to about 18% by weight. The PTFE-lubricant admixture is refrigerated overnight, then is formed into an extrusion billet by pouring the PTFE-lubricant admixture into an upright vertical stainless steel cylinder having a central co-axial vertical preform shaft therein. The vertical stainless steel cylinder is a billet preform which has a diameter corresponding to a diameter of an
25 extrusion barrel in a ram extruder used to extrude the billet. For example, if the ram extruder has an extrusion barrel inner diameter of 3.81 cm, it is desirable for the extrusion billet to have an outer diameter no greater than 3.81 cm. Thus, it is preferable to match the inner diameter of the billet preform to the inner diameter of the extrusion barrel. Once the PTFE-lubricant admixture is poured into the upright vertical billet preform, an annular ram

plate is engaged over the central co-axial vertical shaft and within the billet preform. A ram press is then engaged onto the annular ram plate and the PTFE-lubricant admixture is compressed under pressure until a compacted extrusion billet is formed at step 54. The extrusion billet produced at step 54 is then removed from the billet preform and the preform shaft and engaged upon an extrusion shaft and extrusion mandrel and introduced into the extrusion barrel of a ram extruder. The billet is then extruded at step 55 in a ram extruder having an annular extrusion orifice formed between the inner diameter of the extrusion die and the extrusion mandrel tip concentrically engaged within the extrusion die. To form PTFE tubes, the extrusion die has a frustroconical taper with a conical taper along the axis of extrusion. A mandrel tip is engaged onto the extrusion shaft at its distal end along the axis of extrusion. The mandrel tip also has a conical taper along the axis of extrusion. The degree to which the PTFE extrusion billet is reduced in cross-sectional area as it passes during extrusion is known as the "reduction ratio" and is expressed by the following equation:

$$RR = \frac{\Pi\left(\frac{D_{barrel}}{2}\right)^2 - \Pi\left(\frac{D_{shaft}}{2}\right)^2}{\Pi\left(\frac{D_{die}}{2}\right)^2 - \Pi\left(\frac{D_{mandrel}}{2}\right)^2}$$

in which RR is the reduction ratio, D_{barrel} is the inner diameter of the extruder barrel, D_{shaft} is the outer diameter of the extrusion shaft, D_{die} is the inner diameter of the exit orifice of the extrusion die and $D_{mandrel}$ is the outer diameter of the extrusion mandrel at its distal end relative to the axis of extrusion.

As the tubular PTFE is extruded, it issues from the die exit orifice as a continuous tubular PTFE extrudate and is cut using a sharp razor blade into any length desired, e.g., 30 cm lengths. The PTFE tubular extrudate lengths are then introduced into an oven at a temperature below the flash point of the lubricant, for example at 40° C for ISOPAR H (Exxon Chemical), for a period of time sufficient to drive off and dry, at step 56, substantially all of the lubricant present in the PTFE tubular extrudate, for example, for about 60 minutes. Once the PTFE tubular extrudate is dried of lubricant, expansion plugs

are secured into the tube lumen at each opposing end of the PTFE tubular extrudate length, and the plugged PTFE tubular extrudates are mounted onto an expansion rack. The expansion rack is designed to be mounted into an expansion oven and has a gear, screw, or rail driven moveable stage to which one end of the PTFE tubular extrudate is attached and a stationary stage to which another end of the PTFE tubular extrudate is attached. The PTFE tubular extrudate, mounted on the expansion rack, is introduced into an expansion oven heated to a temperature below the second crystalline melt point of PTFE, preferably between 125 and 340 °C, most preferably between 150 and 200 °C, and allowed to dwell in the expansion oven for a period of time between 5 and 10 minutes, preferably about 7-8 minutes, before longitudinally expanding the PTFE tubular extrudate.

Longitudinal expansion of the tubular PTFE extrudates at step 57 is performed after the dwell time for the PTFE extrudates has elapsed. Wide variation in the expansion rate for making different ePTFE products is known. However, in order to impart increased ability of the inventive rePTFE to radially expand at applied pressures of less than about 6 atm., it is preferable that the longitudinal expansion be performed at a rate between about 10 and 200%/sec.

After the PTFE extrudates have been longitudinally expanded at step 57, and prior to sintering the PTFE extrudates, the unsintered PTFE extrudates may either be concentrically laminated with other larger or smaller diameter unsintered PTFE extrudates, or may be concentrically positioned about luminal and abluminal surfaces of an endoluminal stent at step 58. An endoluminal stent, which may be a balloon expandable, self-expandable or a shape memory stent, may be introduced at step 59 by concentrically positioning an endoluminal stent around a first unsintered PTFE extrudate, then a second unsintered PTFE extrudate of a slightly larger inner diameter may be introduced concentrically around the first unsintered PTFE extrudate and the endoluminal stent, as more fully described in co-pending PCT International Application WO96/28115, published 19 September, 1996, claiming priority from co-pending U.S. Patent Applications Serial Nos. 08/401,871 filed March 10, 1995 and 08/508,033 filed July 27, 1995, which are

expressly incorporated by reference as exemplifying a process for making an encapsulated stent graft.

If the introduction of a stent is not desired, or if the stent is to be positioned along only a particular longitudinal section of a PTFE extrudate, the PTFE tubular extrudates
5 concentrically positioned relative to one another are then laminated by application of a helically applied tension wrap of non-porous PTFE tape which applies a circumferential pressure to the concentrically positioned laminated tubular PTFE extrudates and/or to the concentrically positioned laminated tubular PTFE extrudates and stent assembly at step 60.

The wrapped assembly, either a laminated tubular PTFE extrudate assembly or a
10 laminated tubular PTFE extrudate and endoluminal stent assembly, is then introduced into a sintering oven set to heat the wrapped assembly to a temperature above the second transition crystalline melt point of PTFE, *i.e.*, above 342 °C, preferably 375 °C +10 -5, for a period of time sufficient to fully sinter the PTFE laminated assembly. In order to increase the bond strength between adjacent PTFE layers in the laminated tubular PTFE extrudate
15 assembly or the laminated tubular PTFE extrudate and endoluminal stent assembly, it has been found desirable to utilize a sintering oven having a radiant heating source and sinter the wrapped assembly between 8 to 12 minutes. Alternatively, the wrapped assembly may be sintered in a convection oven for a period of time preferably between 45 and 90 seconds, most preferably between 60 and 90 seconds.

20 After being removed from the sintering oven and allowed to cool, the helical wrap of PTFE tape is removed from the wrapped assembly and the assembly is inspected for material characterization and defects, then sterilized for physiological use.

Table 1, below, summarizes the preferred processing parameters used for making the inventive rePTFE tubular grafts which exhibit up to 700% radial expandability at applied
25 pressures of less than about 6 atm, preferably less than or equal to about 4 atm., most preferably between 2-3 atm.

TABLE 1

	ERF 1683	ERF 1687	ERF 1689	ERF _{encap}
Resin Type	CD 123	CD 123	CD 123	CD 123
Resin Amt (g)	500	500	500	500
Lube Amt. (g)	87	87	100	110
Reduction Ratio	239	239	239	239
Expansion Ratio	5.3:1	5.3:1	5.3:1	6:1
Expansion Rate (%/sec)	200	10	200	200
Expansion Temp. (°C)	150	340	340	200
Expansion Time (min)	5	5	5	7
Sintering Temp. (°C)	375	375	375	367
Sintering Time (sec)	60	60	60	480
Expansion Pressure (atm)	2.8 ± 0.1	2.6 ± 0.28	2.3 ± 0.12	n/a

The following examples set forth the procedures used in making the rePTFE grafts summarized in Table 1, above.

EXAMPLE 1

A 3 mm inner diameter (ID) radially expandable ePTFE tube was fabricated by admixing 500g of CD-123 PTFE resin (ICI Americas, Inc.) with 87g of ISOPAR H (Exxon Chemicals), yielding a 17.4% lubricant level ("Lube Level") in the admixture. The admixture was mixed by rolling in a glass container, then incubated at 40°C for 6 to 8 hours. After incubation, the admixture was poured into a cylindrical pre-form having an inner diameter of 3.81 cm. And compressed in a vertical ram press at about 1,100 psi to form a cylindrical extrusion billet. The extrusion billet was carefully removed from the cylindrical pre-form, wrapped in aluminum foil and incubated prior to use.

The extrusion billet was mounted onto a cylindrical stainless steel base shaft having a diameter of 0.357 cm which passed through the central longitudinal axis of the extrusion billet and projected beyond both ends of the extrusion billet. A tapered extrusion mandrel

has a proximal end which is coupled to the base shaft and has proximal end diameter of 0.357cm and tapers to a mandrel tip at the distal end of the mandrel which has an outer diameter of 0.335 cm. The extrusion billet was then mounted in the extrusion barrel of a ram extruder, the extrusion barrel having an inner diameter of 3.81 cm, and a tapered
5 extrusion die having an entry opening inner diameter of 3.81 cm tapering to a circular exit orifice of 0.412 cm inner diameter. The mandrel tip is co-axially aligned to pass centrally into the circular exit orifice of the extrusion die forming an annular exit orifice. The annular exit orifice is defined between the inner surface of the circular exit orifice of the extrusion die and the outer surface of the mandrel tip and forms an opening having a thickness of
10 0.076 cm. The extrusion billet is then extruded in the ram extruder at an extrusion speed of 3000 mm/min to yield a wet tubular extrudate. The wet tubular extrudate is cut using a razor blade into 30 cm sections as it issues from the extrusion die.

Cylindrical stainless steel expansion plugs are inserted into the opposing ends of the wet tubular extrudate and secured by crimping a metal band about the outer surface of the
15 wet tubular extrudate to create an interference fit between the crimped metal band, the PTFE wet tubular extrudate and the plug, as more fully explained in U.S. Patent No. 5,453,235, which is hereby incorporated by reference for the procedure of affixing the plugs to the tubular extrudate.

The wet tubular extrudate is then mounted onto a drying and expansion rack and
20 introduced into a pre-heated oven at 40°C for 60 minutes to dry the lubricant from the PTFE resin. The dried tubular extrudate is then allowed to dwell in an oven heated to 340°C, then longitudinally expanded at an expansion rate of 200%/sec for an overall longitudinal expansion ratio of 530%. The longitudinally expanded extrudate is then sintered at 375°C for 60 seconds and removed from the sintering oven, removed from the
25 drying and expansion rack, hung vertically and allowed to cool.

After cooling, the expansion plugs and crimp bands are removed from the ePTFE tubes and sterilized in ethylene oxide. The 3 mm inner diameter radially expandable tubes produced in the Example 1 tube are hereinafter referred to as lot ERF 1683.

EXAMPLE 2

The same processing parameters were followed in as in Example 1, except that the expansion rate was changed to 10%/sec. 3 mm inner diameter radially expandable tubes produced in Example 2 are hereinafter referred to as lot ERF 1687.

5

EXAMPLE 3

The same processing parameters were followed as in Example 1, except that the lubricant amount was changed to 100g yielding a lube level of 20%. The 3 mm inner diameter radially expandable tubes produced in Example 3 are hereinafter referred to as lot ERF 1689.

10

EXAMPLE 4

The same process parameters were followed as in Example 1, except that the lubricant amount was changed to 110g, yielding a lube level of 22%, the expansion ratio was changed to 6:1, the PTFE extrudate was allowed to dwell in the expansion oven for 7 minutes prior to expansion and the expansion was conducted at 200 °C. The resulting 3 mm inner diameter radially expandable tubes produced in Example 4 are hereinafter referred to as lot ERF_{encap}.

15

EXAMPLE 5

One 3 mm and one 4 mm ID unsintered tube produced in accordance with the process in Example 4 were obtained. A 3mm inner diameter (ID) unsintered tube was loaded onto a 3.56 mm mandrel. Opposing end sections of the tube were wrapped with TEFLON tape to prevent slippage on the mandrel. Next, two P-394 "PALMAZ" stents and two P-308 "PALMAZ" stents were pre-dilated on a 4.74 mm mandrel. The pre-dilated stents were then loaded over the 3 mm ePTFE tube and spaced equidistantly from one another along the length of the 3 mm ePTFE graft. The pre-dilated stents were then

20

crimped down onto the mandrel and the outer surface of the 3 mm ePTFE graft. Next, a 4 mm ID graft was loaded over the crimped stents. The 4 mm ePTFE graft was wire wrapped onto the assembly at its ends and between the crimped stents. Subsequent to the loading steps, the wrapped assembly was then warmed in a radiant heat oven at 340° C for 30 seconds and then removed. The entire assembly was then wrapped with TEFLON tape using a helical winder set to apply the winding at 1.7 psi. The wrapped assembly was then placed in a radiant heat sintering oven preheated to 400° C and heated at sintering temperatures of 367° C for a total of 8 minutes. The TEFLON taped assembly was then removed from the oven and the TEFLON tape and wire wraps were removed. The ePTFE grafts were then cut about one inch outside of each of the ends of the stents. Finally, the resulting encapsulated stents were gently removed from the mandrel one at a time and then cut to provide a 3 mm ePTFE overhang at both ends of the individual stents. Sintering in a radiant heat oven for longer periods of time than in a convection oven was found to increase the bond strength of the laminated PTFE layers in the encapsulated stent.

Ten encapsulated stents were tested for bond strength between the inner and outer ePTFE layers of the encapsulated stent. The bond strength testing was quantified by performing longitudinal peel tests on an INSTRON tester and formalizing for adhesion strength per unit length. Each encapsulated stent was cut into two strips (A & B) with each strip being approximately 5.5 mm wide and 25.4 mm long. Opposing surfaces on the encapsulated stent strips were each attached to an INSTRON tester and the tester actuated to peel the strips. Table 2, below, summarizes the results of the peel test and reflects the bond strength of the samples tested.

TABLE 2

Run	Average Bond Strength (A&B) [n=10] g/mm	Std. Dev.
1	24.735	0.0332
2	28.917	0.0511
3	21.688	0.0379
4	19.648	0.0447
5	17.168	0.0220
6	26.543	0.0163
7	20.178	0.0306
8	20.270	0.0541
9	37.245	0.0397

Physical and Structural Characterization Test Procedures

The physical and structural test data obtained from testing material obtained from each of the foregoing examples is set forth in Tables 3-8, below. The tests used to generate the data are based upon the standards developed by the Association for the Advancement of Medical Instrumentation (AAMI) and published in the document entitled "Cardiovascular Implants - Vascular Prostheses" and are also approved by the American National Standards Institute (ANSI). The following describes the specific test procedures used to generate the following physical and structural characterization on the inventive radially expandable ePTFE endoluminal graft.

Wall Thickness (WT).

(a) Base Graft: This test was performed on an optical microscope equipped with a vernier stage and eyepiece cross hairs. A 2 cm segment was cut from the graft and mounted on a glass slide with the cut end parallel to the lens. Four measurements of the wall were taken on the circumference 90° apart, and averaged for the representative wall thickness.

(b) Expanded Graft: The above procedure could not be used because the graft material was too thin to be stood upright. Accordingly, a calibrated constant pressure thickness gauge, or snap gauge, was used. A 2cm segment of the expanded graft sample was flattened on a board and three measurements were taken from different areas of the sample. These values were then divided by 2 to obtain the individual wall thickness and then averaged for the reported wall thickness.

Radial Tensile Strength (RTS).

A 1 cm graft segment is mounted onto vice radial-fixtures on an INSTRON tensile tester. The sample is then pulled radially at a rate of 1 in/min to elongate the internal diameter until failure occurs. The peak force is noted and the RTS value is calculated according to the following equation:

$$RTS = \frac{(16.13)(F_p)}{WT_i}$$

where F_p is the recorded peak force in lbs and WT_i is the initial wall thickness of the sample and the RTS value is expressed in psi units.

Internodal Distance (IND).

IND measurement is an evaluation of the node-fibril microstructure of the ePTFE graft. A 1 cm graft segment is cut longitudinally and the sample is flattened into a sheet. The surface to be studied is placed face up on a glass slide prepared with double sided tape. The surface is colored using a contrast dye such as aniline dye. Using an optical microscope with a calipered stage and reticle, the average distance between 2 adjacent nodes is recorded. Three measurements are taken per sample for each side. These readings are then averaged for each of the inner surface (IND_i) and the outer surface (IND_o) of the ePTFE graft and are expressed in μ or 1×10^{-6} meters.

Water Entry Pressure (WEP). Water entry pressure is an indirect measurement of the porosity of the graft which uses pressurized water to evaluate the graft's ability to retain fluid under pressure. Both ends of a 9cm graft sample are securely clamped with hemostats. A 22 gauge hypodermic needle is then introduced at a 45° angle through the graft wall and into the lumen. The graft is then slowly filled with distilled water until the internal water pressure reaches 0.8 to 1.8 psi. The pressure is then increased slowly until the first drop of water appears on the outside surface of the graft. The pressure, in psi, at which the water first appears is the WEP value.

Longitudinal Foreshortening (LFS).

Longitudinal foreshortening is a measurement of the amount by which the graft foreshortens upon radial expansion. A line is drawn along the length of every sample to be tested. The length of the line is measured both before and after radial expansion and the change in length is converted into a percentage by dividing the difference between initial and final lengths and dividing by the initial length.

Radial Expansion Protocol and Test Results.

The following ePTFE grafts were selected for radial expansion testing and characterization:

- 6 mm ID Regular Wall ePTFE Graft (IMPRA Lot 34396).
- 3 mm ID Thin Wall ePTFE Graft (IMPRA Lot 34391).
- 3 mm rePTFE Graft (ERF 1683).
- 3 mm rePTFE Graft (ERF 1687).
- 3 mm rePTFE Graft (ERF 1689).
- 3 mm rePTFE Encapsulated Graft (ERF_{encap}).

Each of the foregoing samples were radially expanded using commercially available angioplasty balloon catheters. Radial expansion was conducted in a water tank held at a constant temperature of 37° C maintained by a circulation pump and heater apparatus. An

electric gear pump (Micropump INTEGRAL Series Model No. HGR004) connected to a variable DC voltage supply was used to provide the required fluid pressure to inflate the balloons. A bypass valve was set to bypass expansion flow if pressures above the rated burst pressure of the balloon were reached. Radial expansion was conducted using balloon catheters as follows:

3 mm Grafts

- (a) 9 mm expansion (3X) using a 9 mm x 8 cm long angioplasty balloon catheter.
- (b) 12 mm expansion (4X) using a 12 mm x 8 cm long angioplasty balloon catheter.
- (c) 15 mm expansion (5X) using a 15 mm x 8 cm long angioplasty balloon catheter.

6 mm Graft

- (a) 18 mm expansion (3X) using a 18 mm x 8 cm long angioplasty balloon catheter.
- (b) 24 mm expansion (4X) using a 24 mm x 8 cm long angioplasty balloon catheter.
- (c) 30 mm expansion (5X) using a 30 mm x 5 cm long angioplasty balloon catheter.

Each graft sample length (70-80 cm) was cut into 2 halves. A first was used for base graft testing and the second half was used for radial expansion. The second half for radial expansion was again cut into three 12 cm sections and each section was numbered with the graft number and an identifier indicating which test it was to be used for, *e.g.*, 3X, 4X or 5X expansion. Each segment was then radially expanded to the maximum balloon diameter in the water bath then held for 1 minute. For the larger expansion ratios, *i.e.*, 5X, it was necessary to pre-expand the graft in order to permit the graft lumen to accept the larger profile balloon. After radial expansion, the balloon was deflated, and the graft removed and set aside for testing.

Tables 3-7 set forth the averaged raw data obtained from testing a 6 mm ID standard PTFE vascular graft (Lot 34396, IMPRA, Inc., Tempe, Arizona), a 3 mm ID standard PTFE vascular graft (Lot 34391, IMPRA, Inc. Tempe Arizona), and the inventive rePTFE grafts, ERF 1683, ERF 1687, and ERF 1689. Figures 13A-24C are the scanning electron micrographs taken of the inner surface and the outer surface of each of the grafts for which the test data in Tables 4-7 is reflected.

TABLE 3

Graft:	Lot 34396	6 mm ID RW PTFE Graft			
	Base	3X	4X	5X	
IND _o	33 ± 1.3	31 ± 1.0	33 ± 0.9	32 ± 0.9	
IND _i	30 ± 1.2	30 ± 1.4	31 ± 0.7	31 ± 0.8	
WEP	5.4 ± 0.23	5.38 ± 0.53	6 ± 0.52	8.5 ± 1.0	
WT	0.72 ± 0.003	0.5 ± 0.032	0.36 ± 0.27	0.33 ± 0.14	
RTS	1143 ± 966	879 ± 80.6	897 ± 310.8	1110 ± 196.5	
FSHT (%)	n/a	1.5 ± 2.34	4.7 ± 3.11	3.5 ± 2.40	

TABLE 4

Graft:	Lot 34391	3mm TW PTFE Graft			
	Base	3X	4X	5X	
IND _o	33 ± 0.8	33 ± 0.8	32 ± 0.5	33 ± 0.9	
IND _i	31 ± 1.2	31 ± 1.2	31 ± 0.8	29 ± 0.9	
WEP	5.5 ± 0.48	5.5 ± 0.29	5.8 ± 0.42	6.2 ± 0.6	
WT	0.38 ± 0.005	0.29 ± 0.009	0.25 ± 0.005	0.23 ± 0.007	
RTS	1321 ± 311.1	856 ± 249.9	955 ± 177.9	880 ± 187.3	
FSHT (%)	n/a	3.5 ± 2.43	3.5 ± 2.42	3.0 ± 2.54	

TABLE 5

Graft:	ERF 1683	3mm TW			
	Base	3X	4X	5X	
IND _o	16.4	15.8	17.5	15	
IND _i	n/a	14.3	12.5	16.5	
WEP	8.08	8.67	9.33	7.97	
WT	0.37	0.37	0.26	0.19	
RTS	487.02	632.59	1007.16	1051.15	
FSHT (%)	n/a	n/a	n/a	n/a	

TABLE 6

Graft:	ERF 1687	3 mm TW		
	Base	3X	4X	5X
IND _o	22.4	39	42.5	39.3
IND _i	n/a	32.5	33.5	36
WEP	4.06	4.53	5.07	5.43
WT	0.39	0.14	0.08	0.07
RTS	749	791.86	1016.54	1550.65
FSHT (%)	n/a	n/a	n/a	n/a

TABLE 7

Graft:	ERF 1689	3 mm TW		
	Base	3X	4X	5X
IND _o	18.2	22.5	26.8	25
IND _i	n/a	17.5	23.5	22.5
WEP	5.14	5.97	6.74	6.57
WT	0.388	0.13	0.11	0.08
RTS	667.2	791.86	1017	1550.65
FSHT (%)	n/a	n/a	n/a	n/a

It is significant to note, paradoxically, that despite the decreases in node density and in fibril density observed as a result of increased degrees of radial expansion, the water entry pressure of the radially expanded graft increases as the graft is radially expanded. The increase in WEP values, as a function of radial expansion, is the result of the increased tortuosity of the rePTFE material microstructure as it is radially expanded from its original diameter to its expanded diameter in each of the rePTFE samples tested.

It will be seen and appreciated by those skilled in the art that an inventive rePTFE tubular graft suitable for endoluminal radial expansion at applied pressures of less than 6 atm has been described with reference to its preferred embodiments and with reference to an inventive method for making the rePTFE tubular endoluminal grafts. The inventive rePTFE tubular grafts each consist of a longitudinally expanded polytetrafluoroethylene tubular member having a continuous substantially concentric wall surface which has no seam and which is radially deformable between about 50% to about 700% its original diameter with application of a radially directed outward pressure of less than about 6 atm without loss of

structural integrity. Structural integrity is considered retained where the microstructure of the ePTFE after radial expansion is substantially free of broken or fractured fibrils and where the following factors are met: 1) IND remains substantially the same as the unexpanded graft; 2) water entry pressure as measured by Association for the Advancement of Medical Instrumentation (AAMI) test method 8.2.4 remains within $\pm 60\%$ of the water entry pressure of the unexpanded graft; 3) the wall thickness of the graft, as determined by AAMI test method 8.7.4, maintains its concentricity as determined by a substantially uniform wall thickness within $\pm 30\%$ about the circumference of the graft; 4) average post-radial expansion wall thickness remains within about $\pm 70\%$ of the average pre-radial expansion wall thickness as determined by AAMI test method 8.7.4; 5) longitudinal tensile strength as AAMI test method 8.3.2 remains within $\pm 100\%$ of the value of the unexpanded graft, when normalized for wall thickness; 6) radial tensile strength as measured by AAMI test method 8.3.1 remains within $\pm 40\%$ of the value of the unexpanded graft, when normalized for wall thickness; and 7) is free of gross tears or fractures.

WHAT IS CLAIMED IS:

1. A continuous tubular structure comprising an expanded polytetrafluoroethylene material having a microstructure characterized by a plurality of nodes interconnected by fibrils, the fibrils having an orientation substantially parallel to the longitudinal axis of the polytetrafluoroethylene tubular material and the nodes having a longitudinal axis substantially perpendicular to the longitudinal axis of the polytetrafluoroethylene material, the polytetrafluoroethylene tubular material being capable of undergoing radial deformation under the influence of a positive pressure applied through the lumen of the polytetrafluoroethylene tubular material and radially outward therefrom which causes a plurality of the nodes in the microstructure to undergo elongation along the longitudinal axis of the nodes, while substantially retaining an average internodal distance throughout the microstructure of the section of polytetrafluoroethylene tubular material which is radially deformed, wherein the expanded polytetrafluoroethylene is radially deformable to at least 50% its original diameter at applied positive pressures less than about 6 atm.
2. The continuous tubular structure according to claim 1, wherein the expanded polytetrafluoroethylene tubular material is radially deformable between about 50% to 700% its original diameter without loss of structure integrity.
3. The continuous tubular structure according to claim 2, wherein the expanded polytetrafluoroethylene is radially deformable to between 50% to 700% its original diameter with water entry pressure remaining within +60% of the water entry pressure value of the non-deformed graft.
4. The continuous tubular structure according to claim 2, wherein the expanded polytetrafluoroethylene is radially deformable to between 50% to 700% its original diameter wherein wall thickness of the graft maintains its concentricity and is free of gross tears or fractures.

5. The continuous tubular structure according to claim 2, wherein the expanded polytetrafluoroethylene is radially deformable to between 50% to 700% its original diameter wherein longitudinal tensile strength remains within $\pm 100\%$ of the value of the unexpanded graft.

5

6. The continuous tubular structure according to claim 2, wherein the expanded polytetrafluoroethylene is radially deformable to between 50% to 700% its original diameter wherein radial tensile strength remains within $\pm 40\%$ of the value of the unexpanded graft.

10

7. The continuous tubular structure according to claim 2, wherein the expanded polytetrafluoroethylene is radially deformable to between 50% to 700% its original diameter wherein average nodal elongation in the radially deformed graft is no more than about 300% the average node length of the unexpanded graft.

15

8. The continuous tubular structure according to claim 2, further including a radially expandable stent member concentrically positioned within the lumen of the tubular structure.

20

9. The continuous tubular structure according to claim 8, wherein the radially expandable stent member is selected from the group of stents consisting of balloon expandable, self expanding and memory shape stent members.

25

10. The continuous tubular structure according to claim 8, further including a second continuous tubular structure comprised of polytetrafluoroethylene concentrically positioned with the lumen of the stent member and in intimate contact with the stent member and the continuous tubular structure.

30

11. The continuous tubular structure according to claim 1, further including a radially expandable stent member concentrically positioned about at least one of an outer, abluminal surface and a lumen surface of the continuous tubular structure.

12. The continuous tubular structure according to claim 11, wherein the radially expandable stent member is selected from the group of stents consisting of balloon expandable, self expanding, and shape memory stent members.

5

Cassan Maclean
Suite 401
80 Aberdeen Street
Ottawa, ON K1S 5R5
Canada

Agents for the Applicant

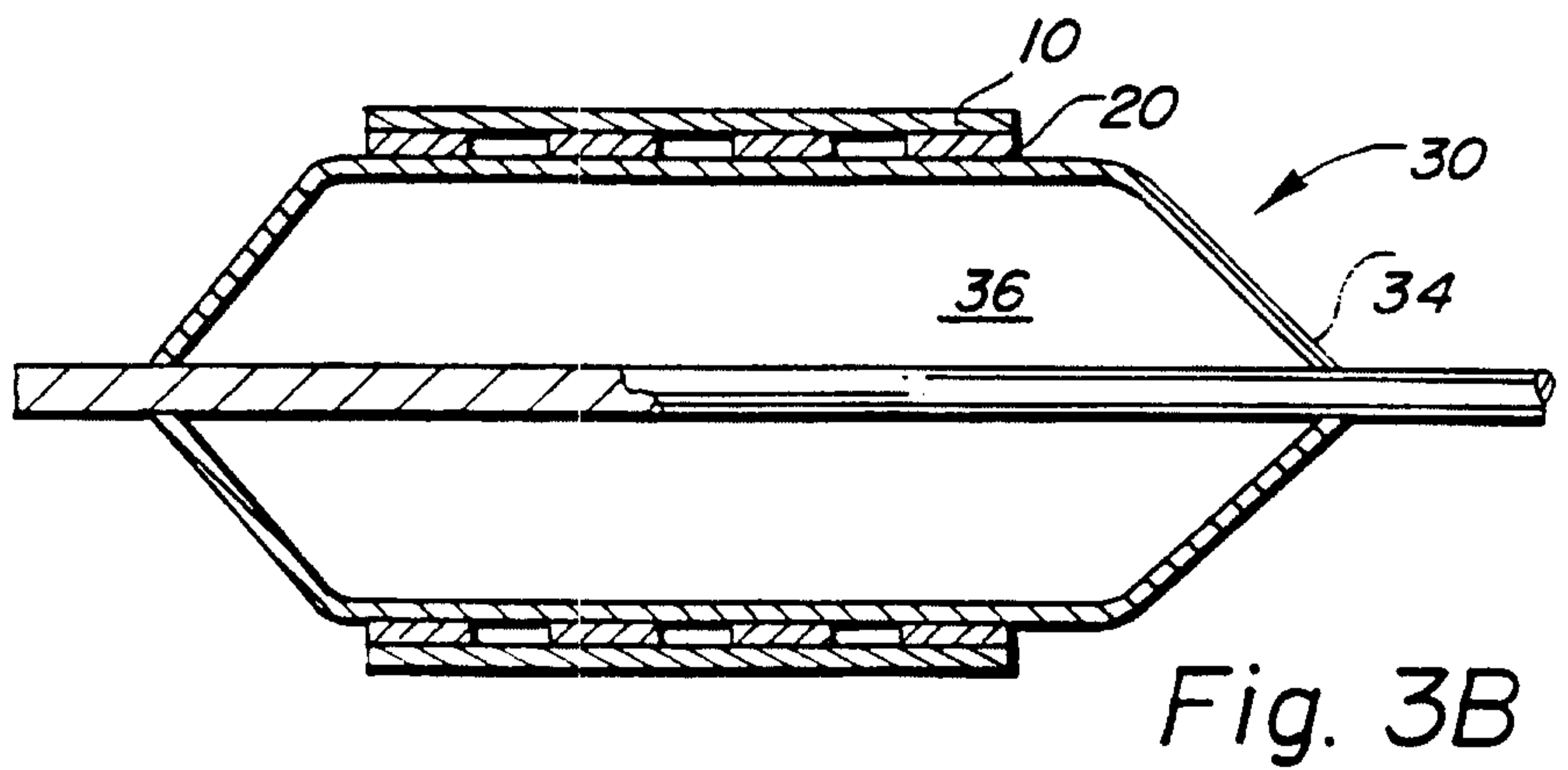
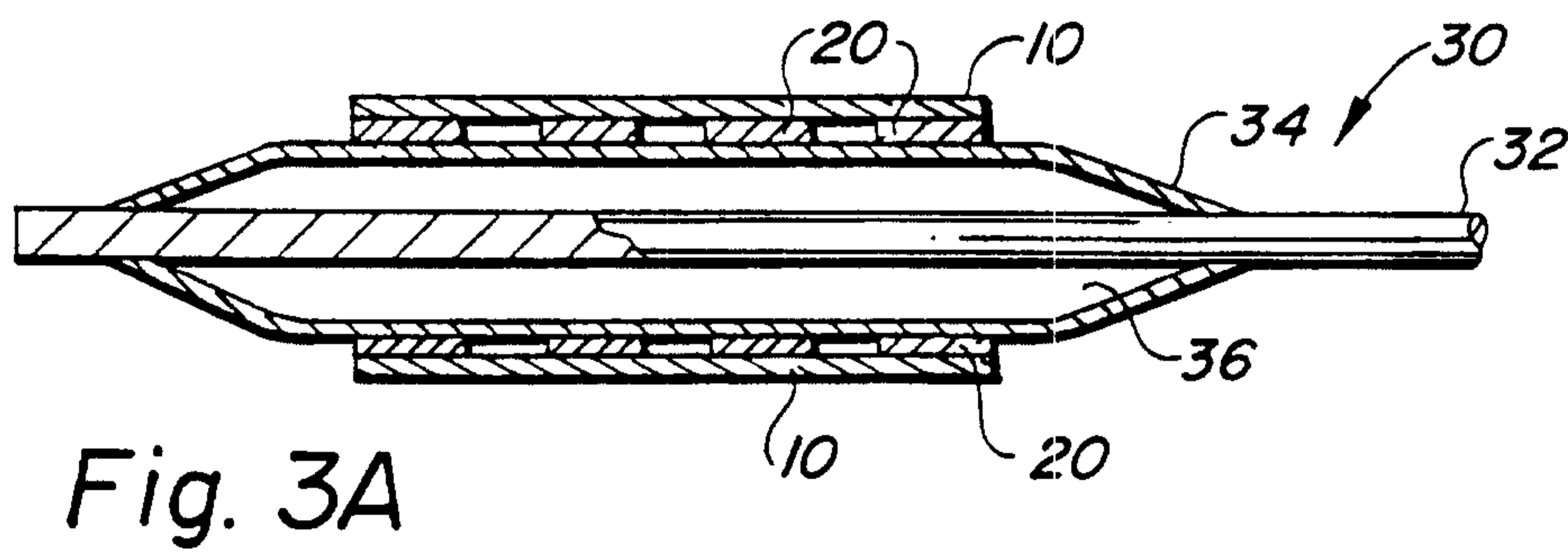
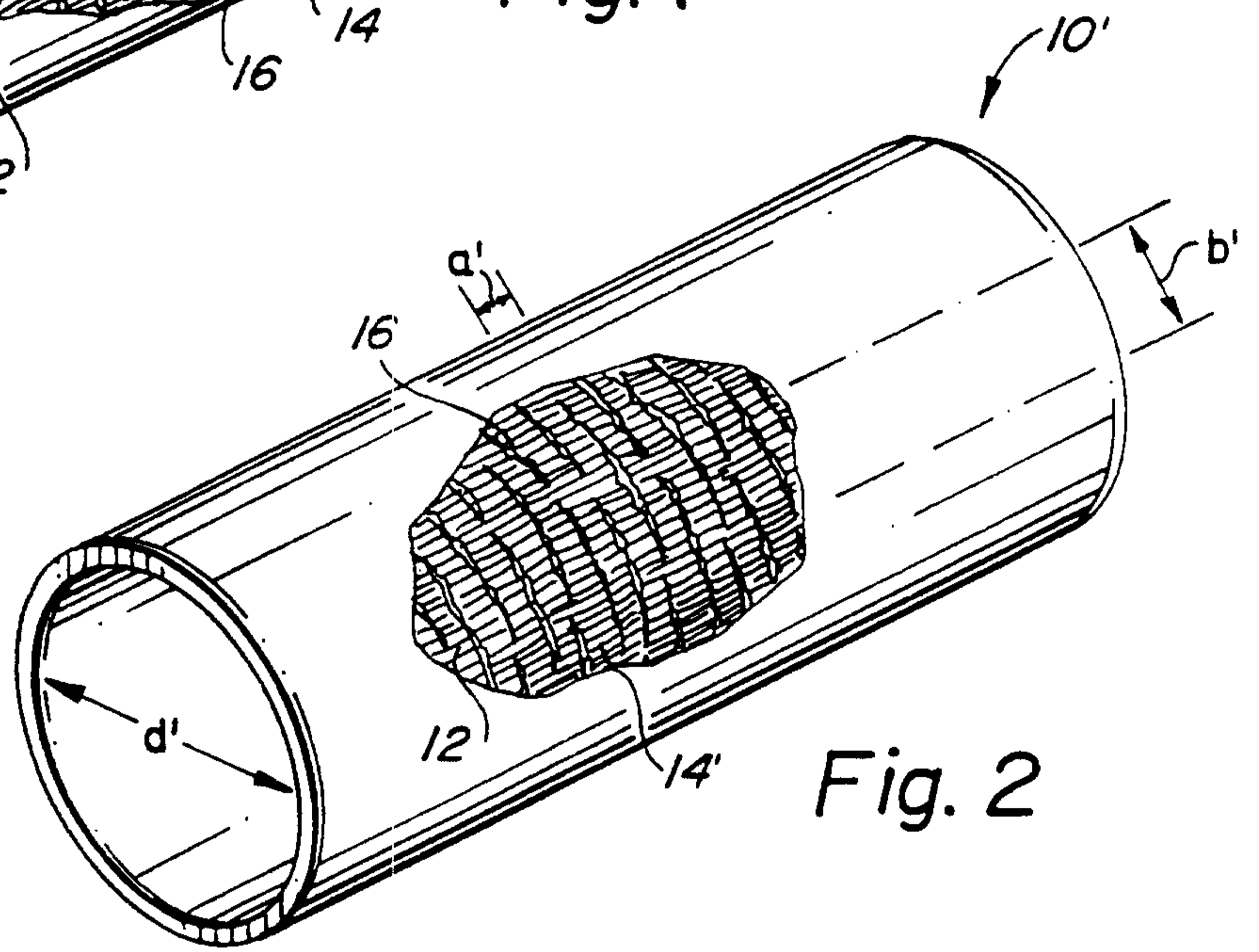
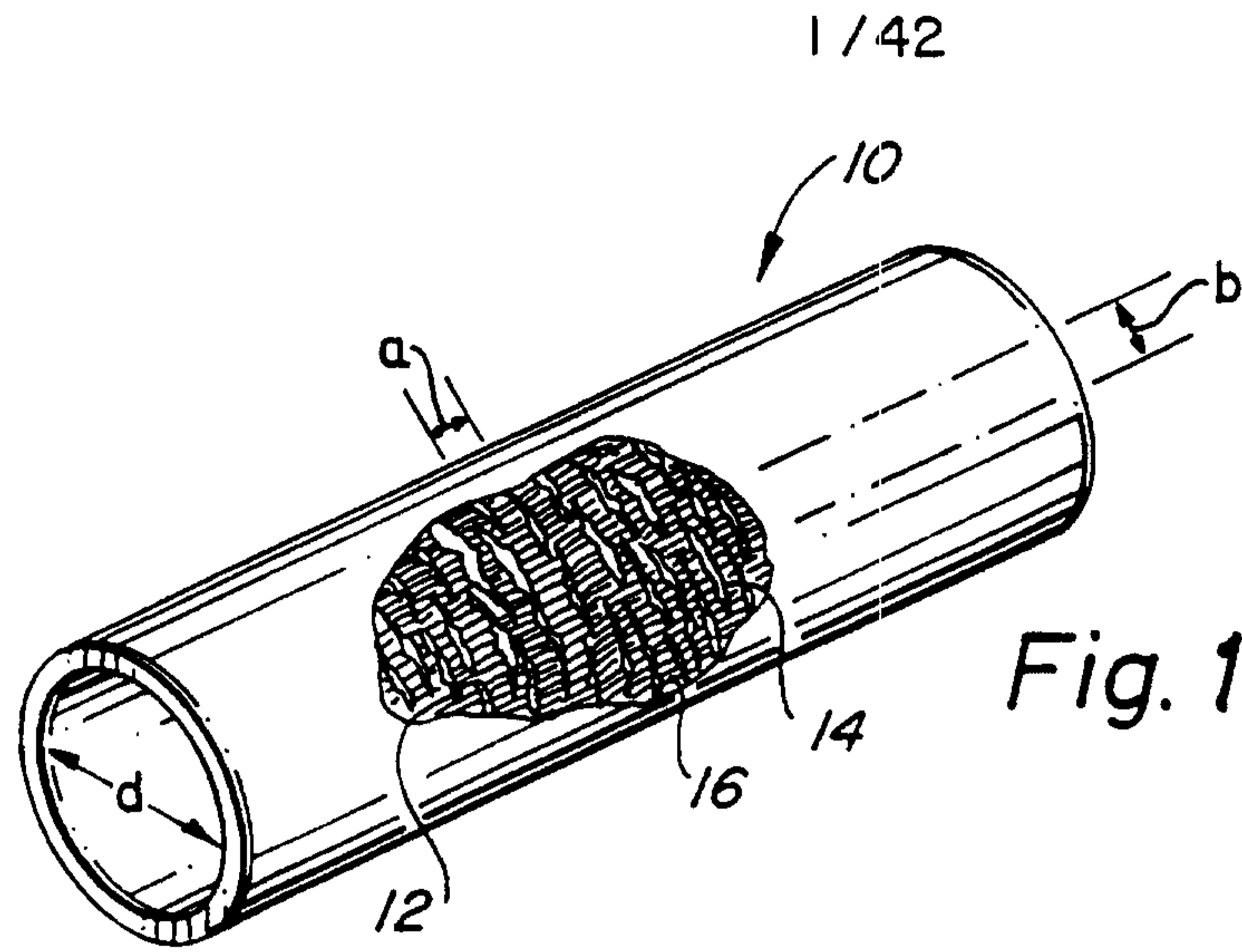

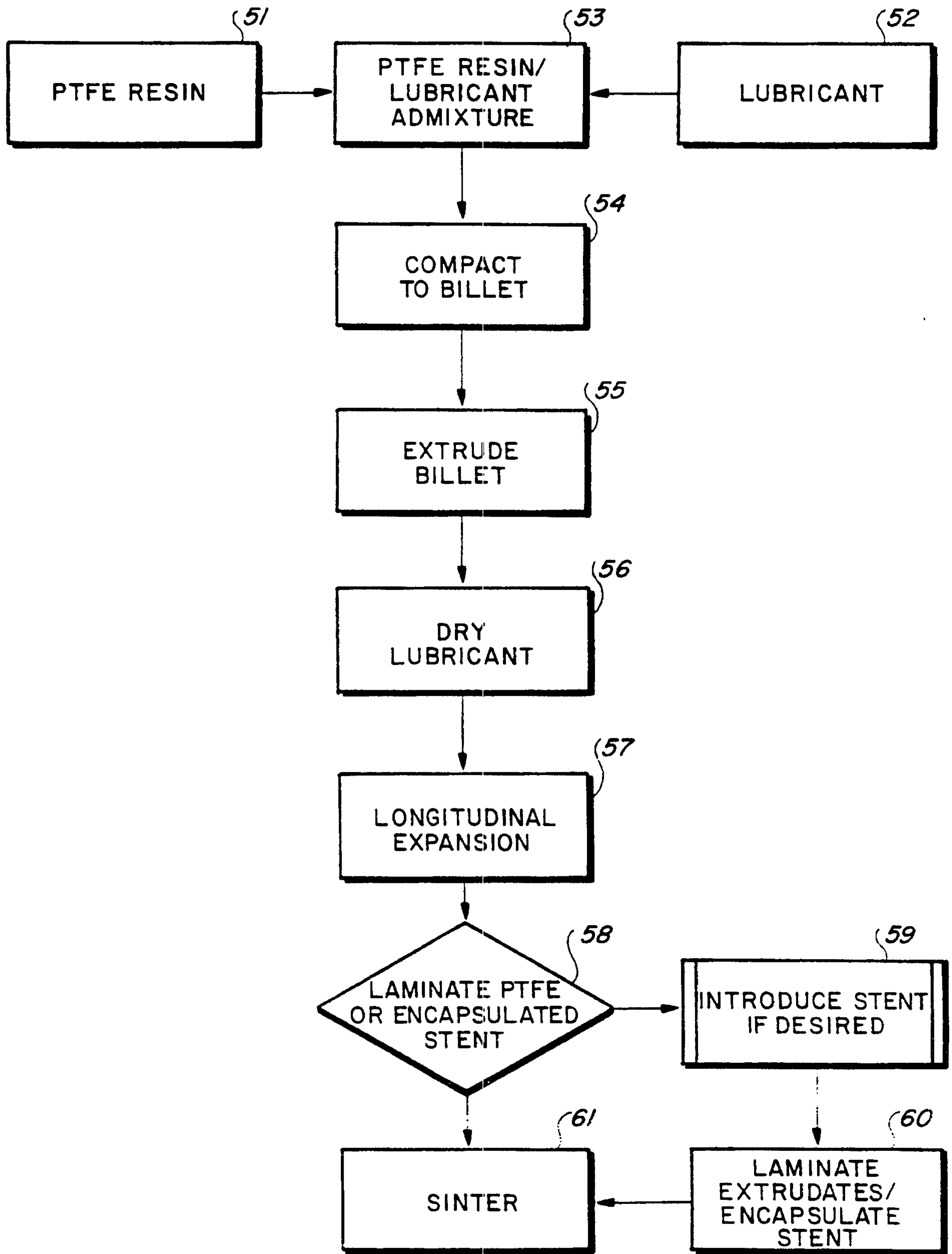

Fig. 4

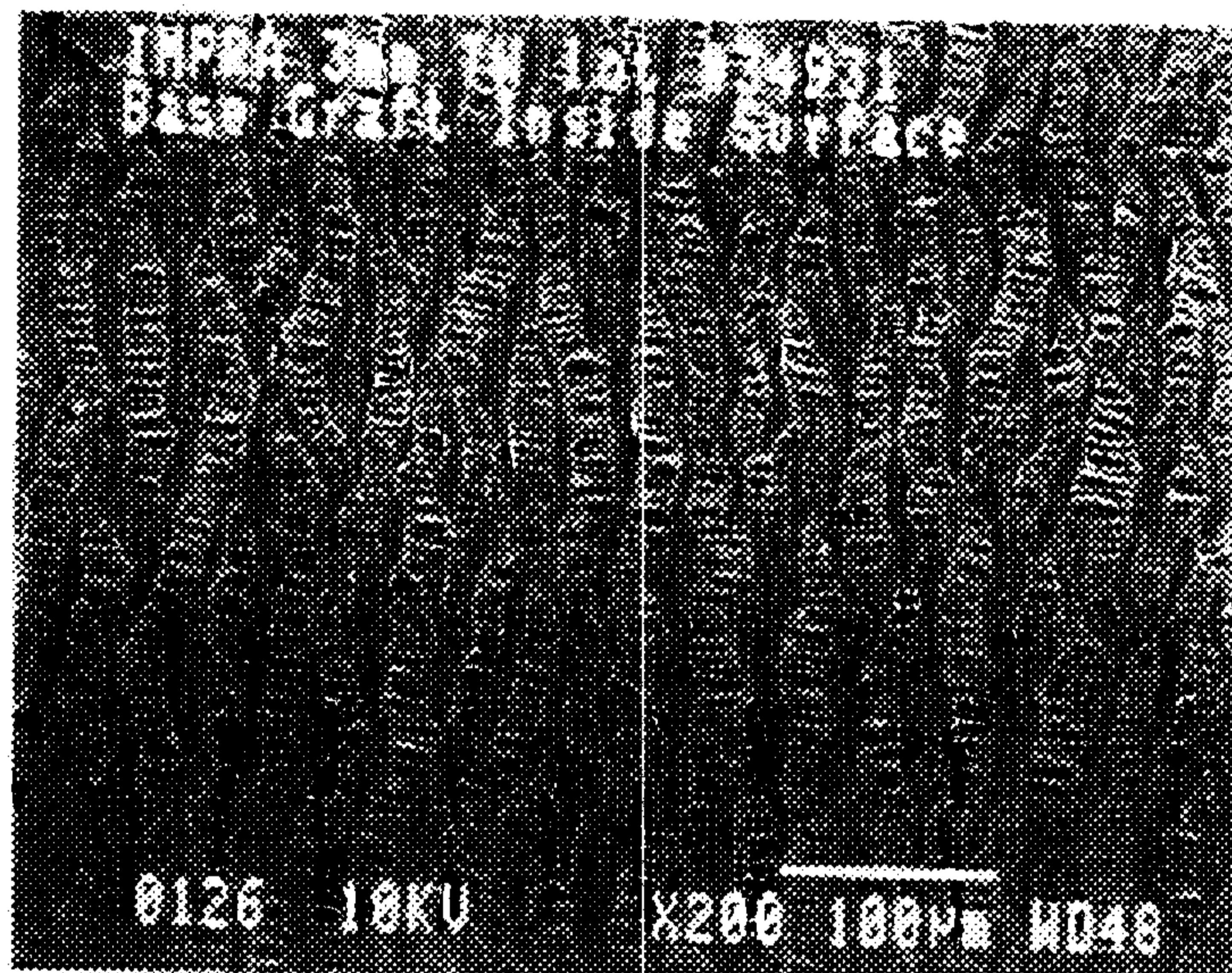

Fig. 5A

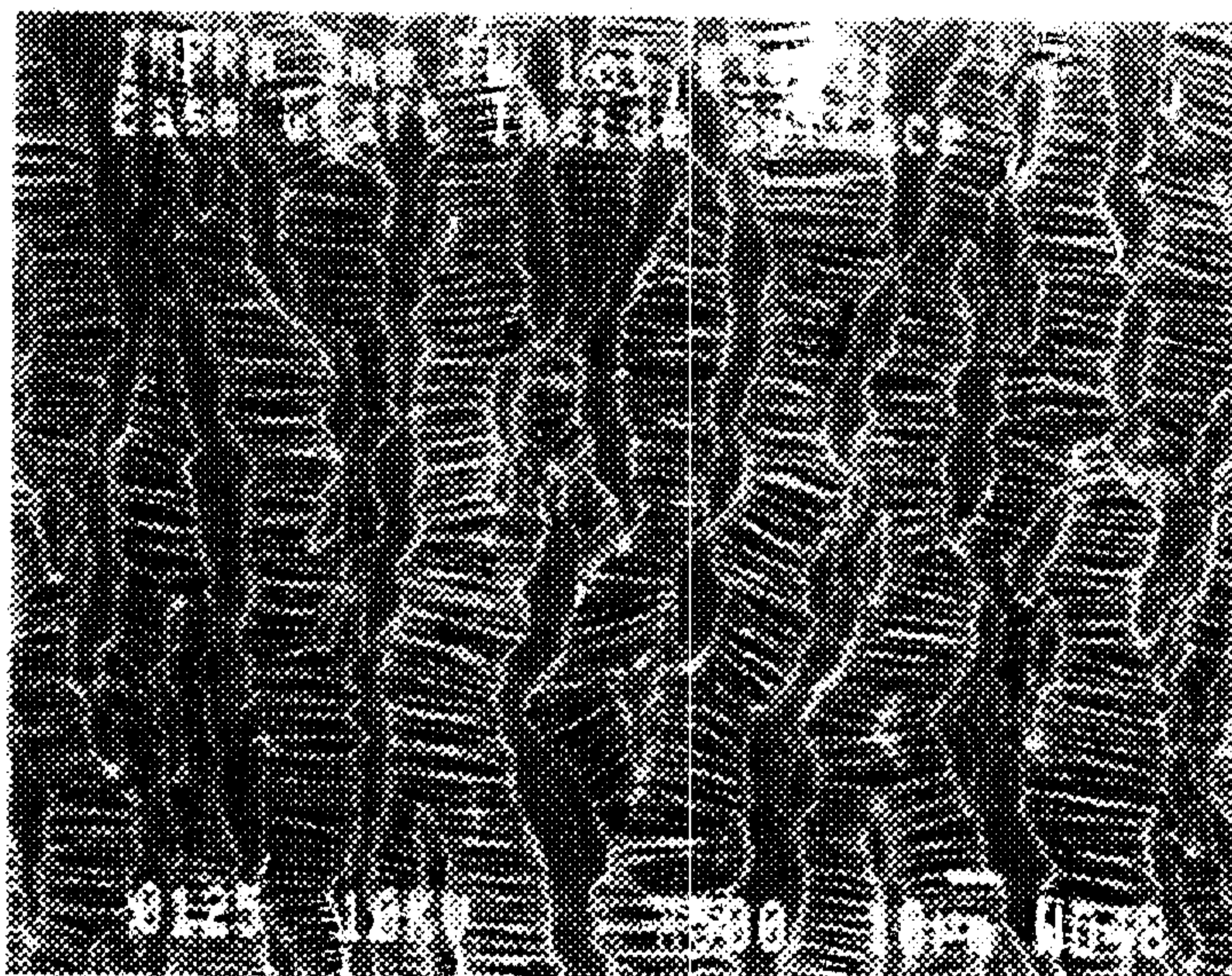

Fig. 5B

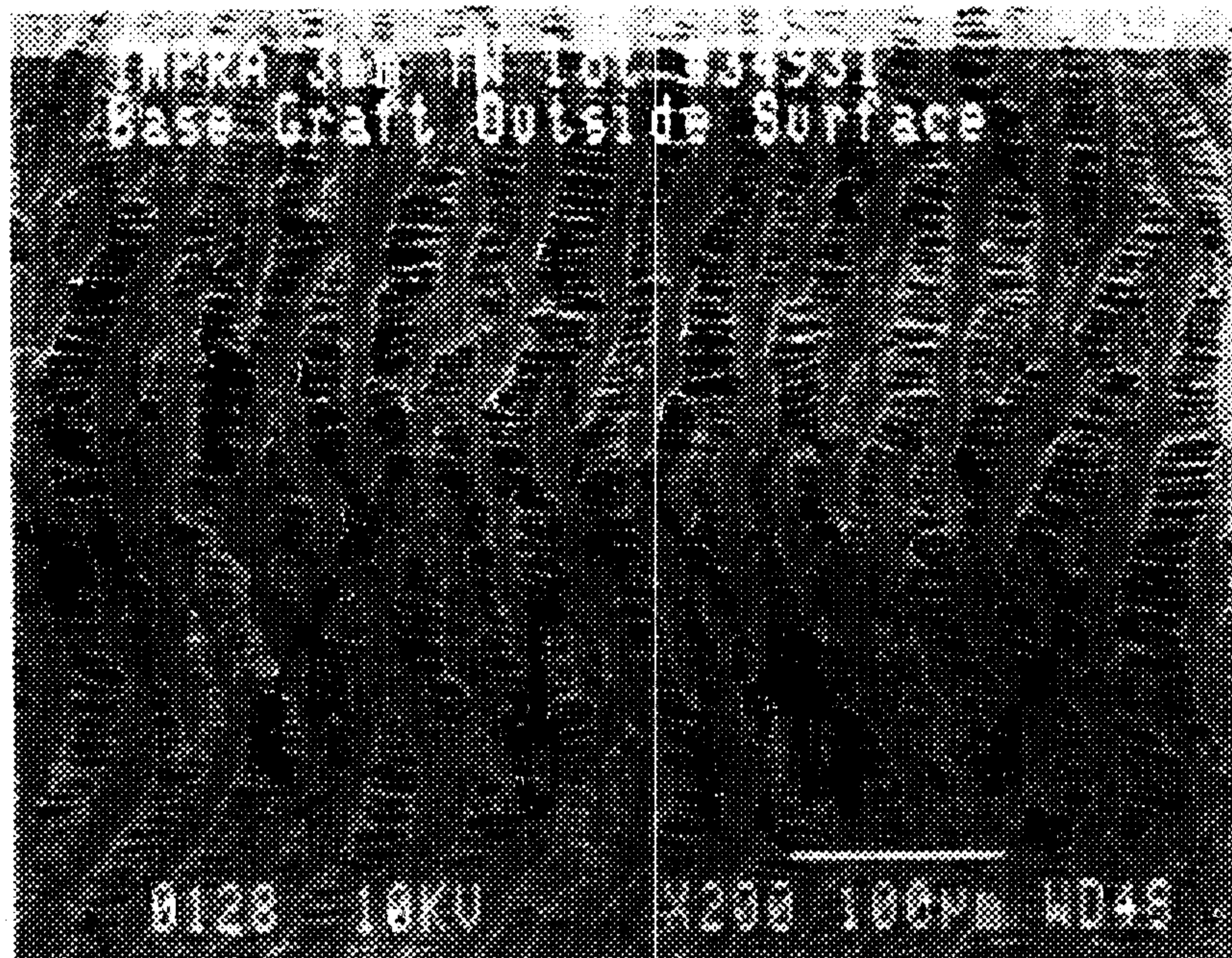

Fig. 5C

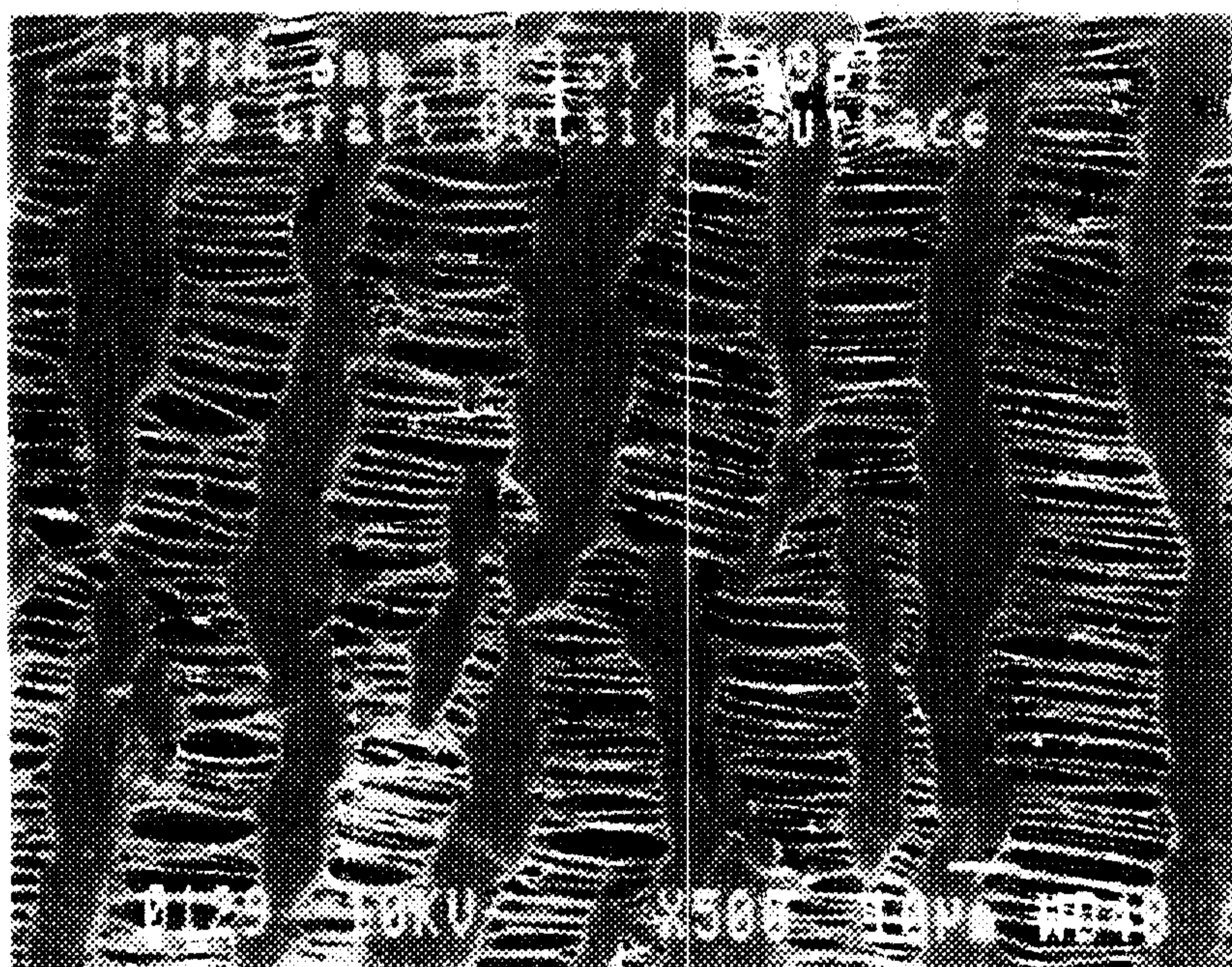

Fig. 5D

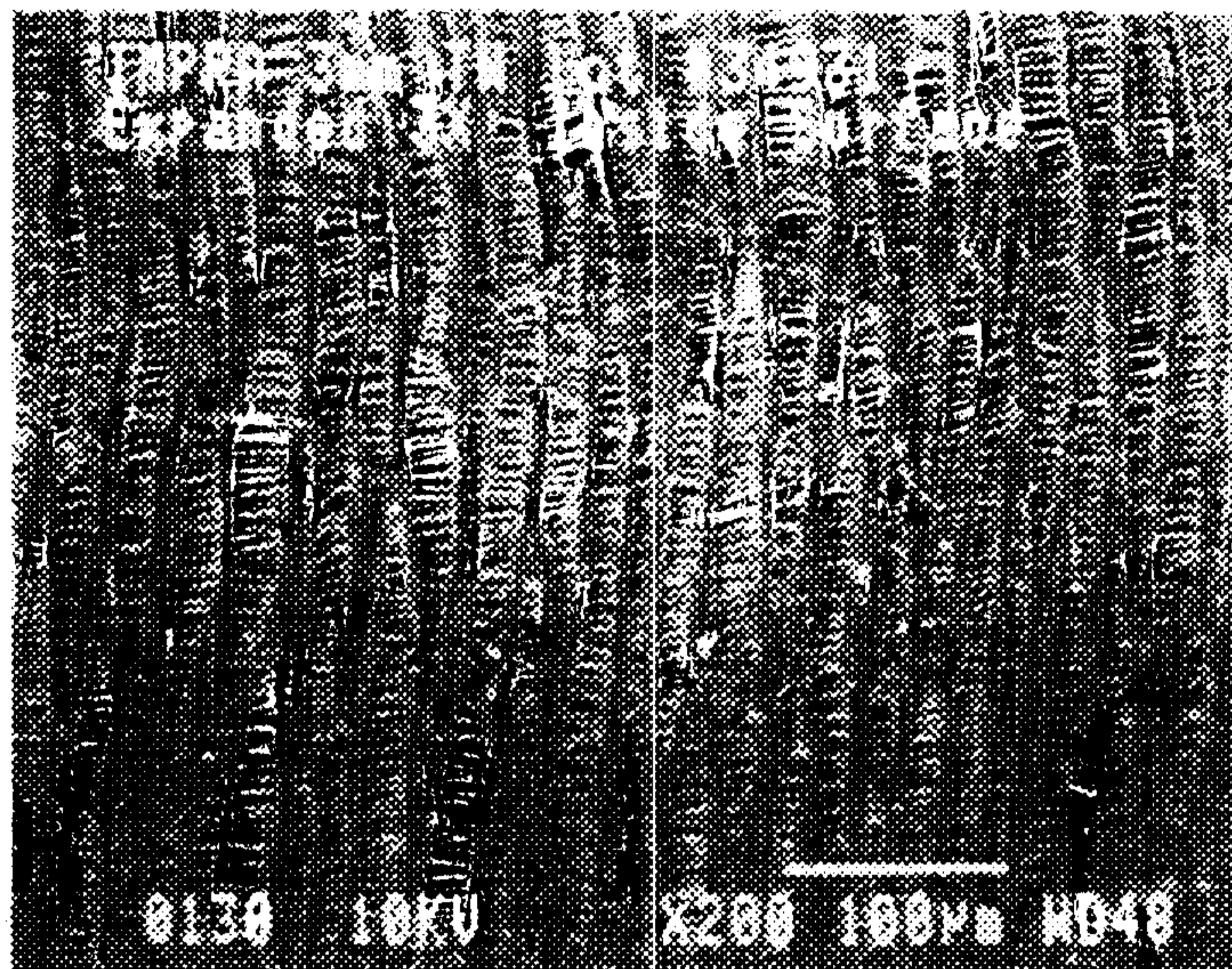

Fig. 6A

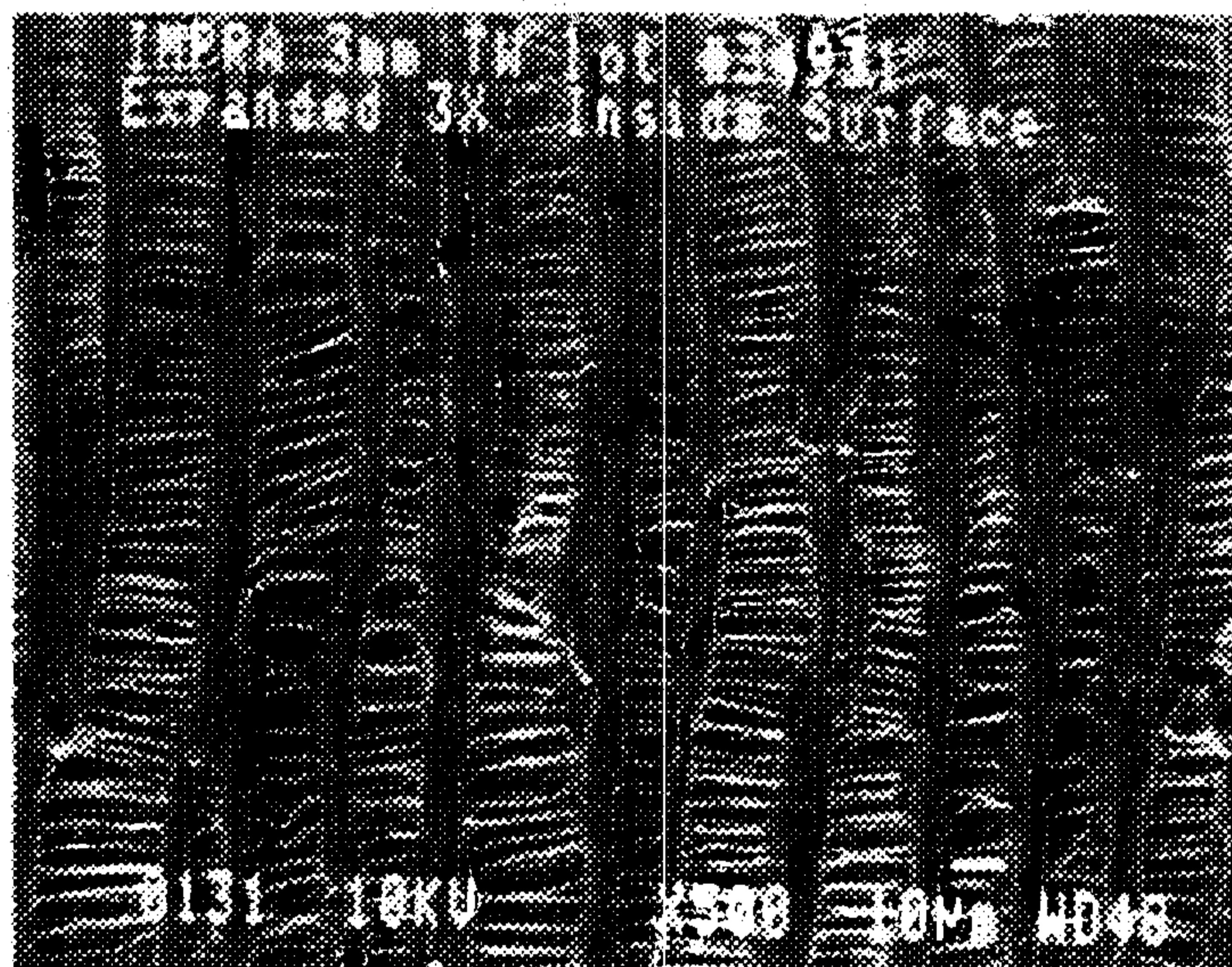

Fig. 6B



Fig. 6C

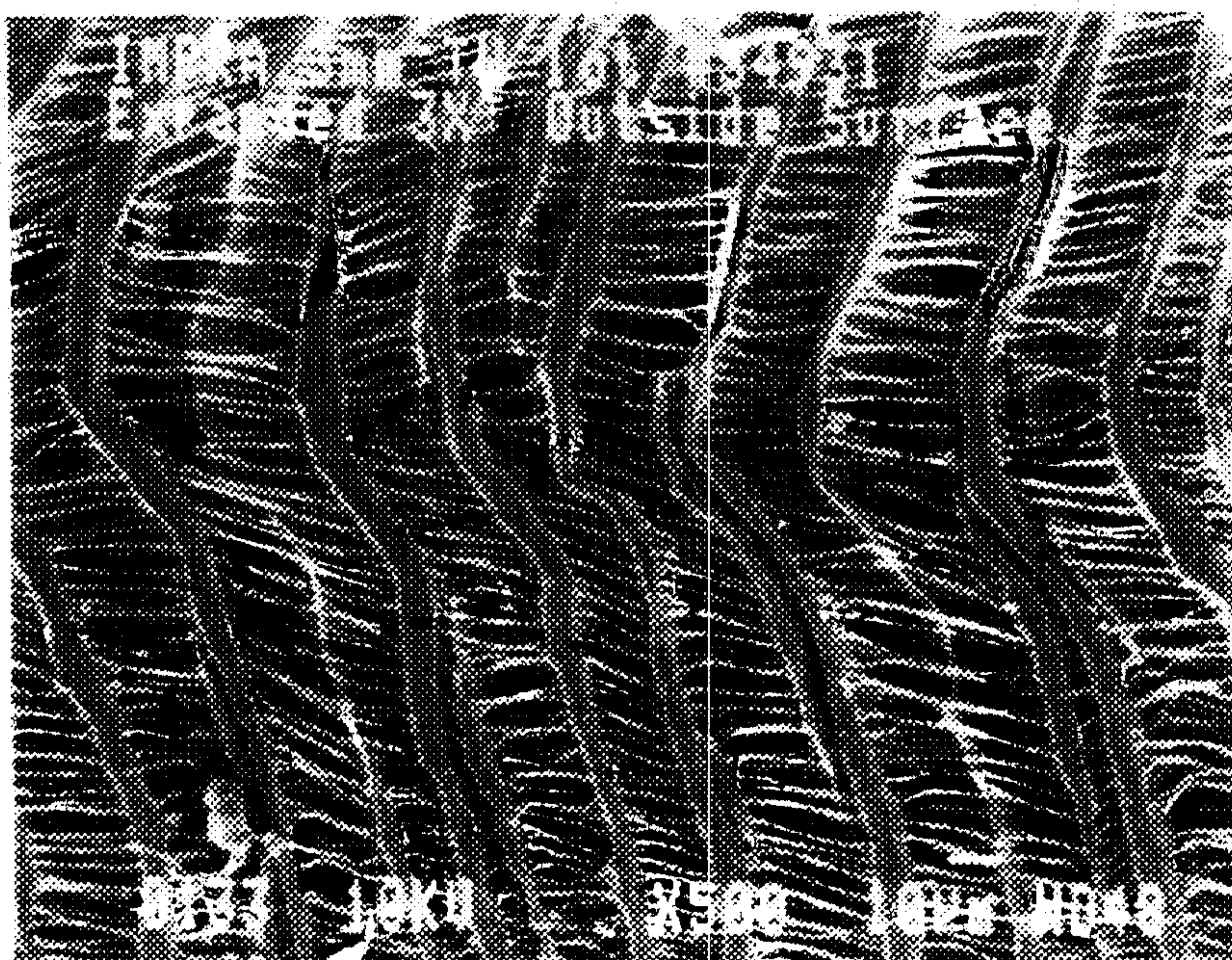

Fig. 6D

7/42

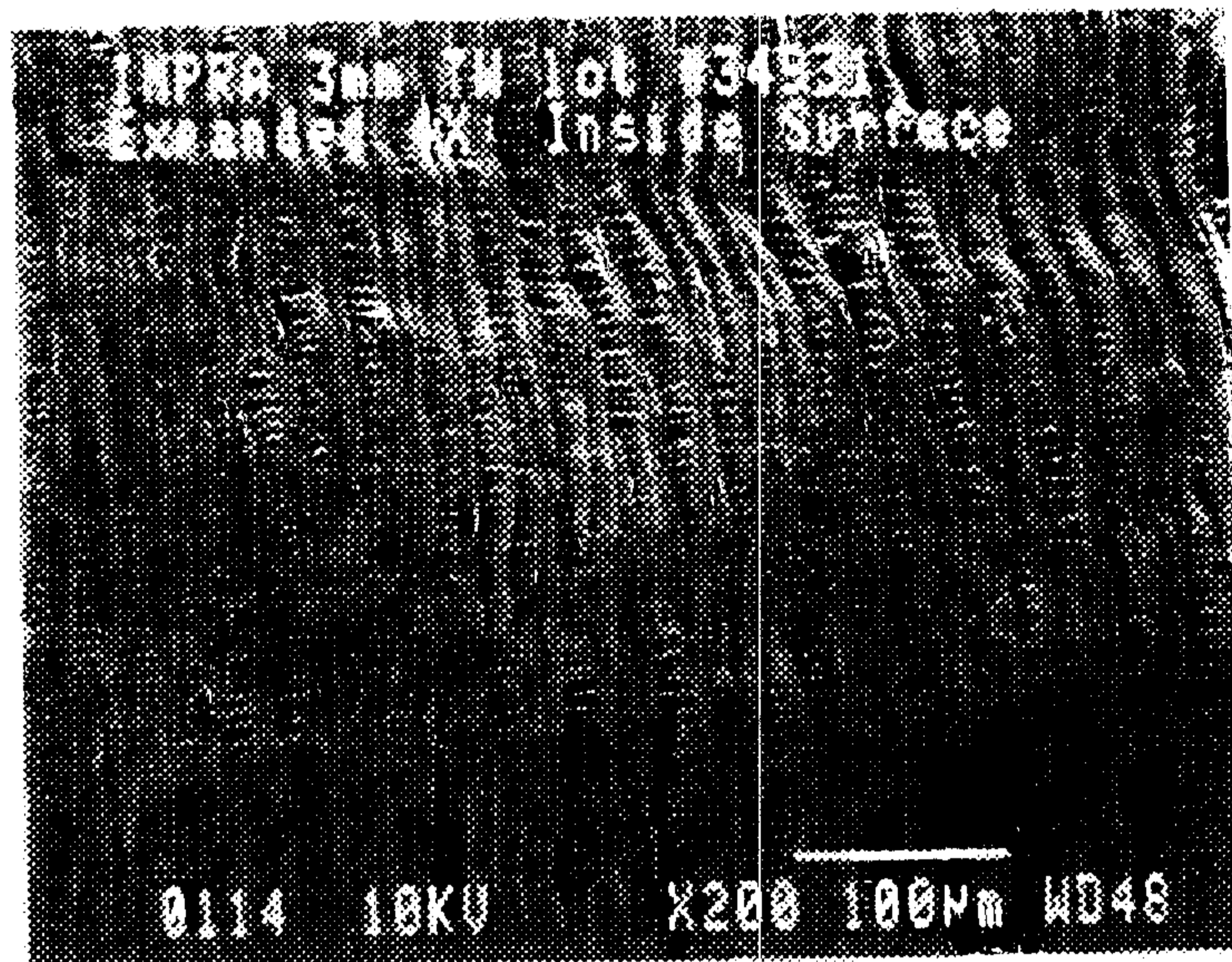

Fig. 7A

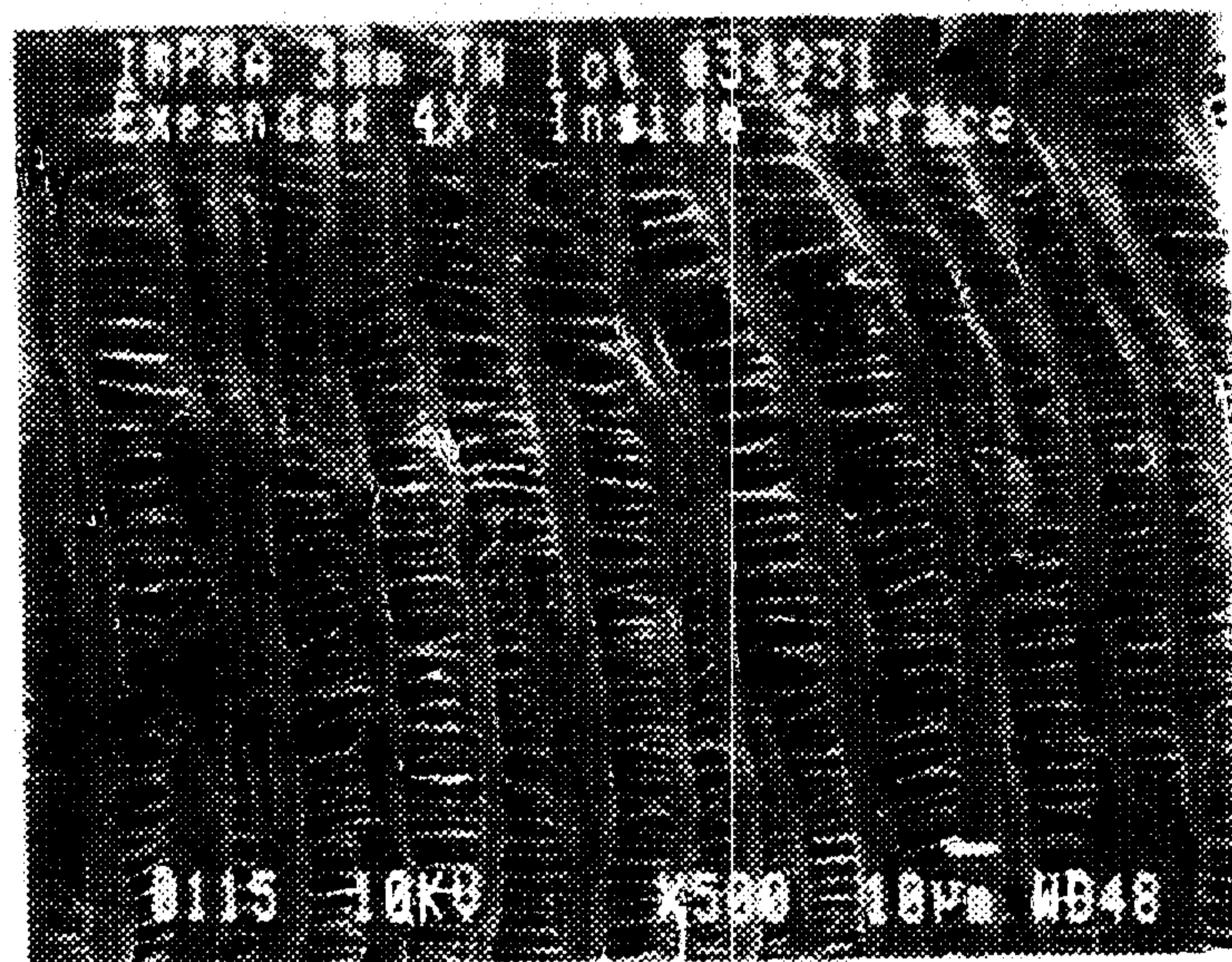

Fig. 7B

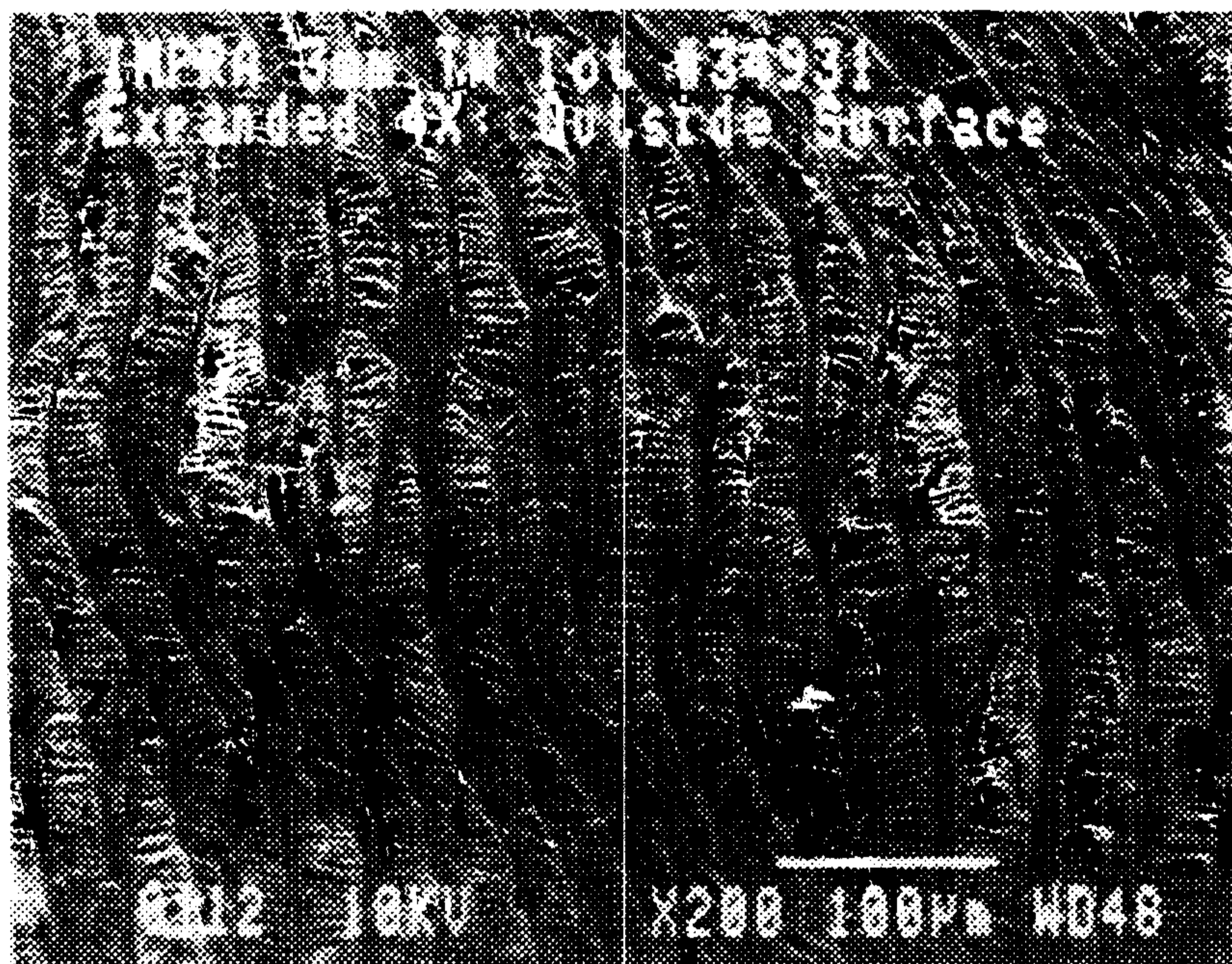

Fig. 7C

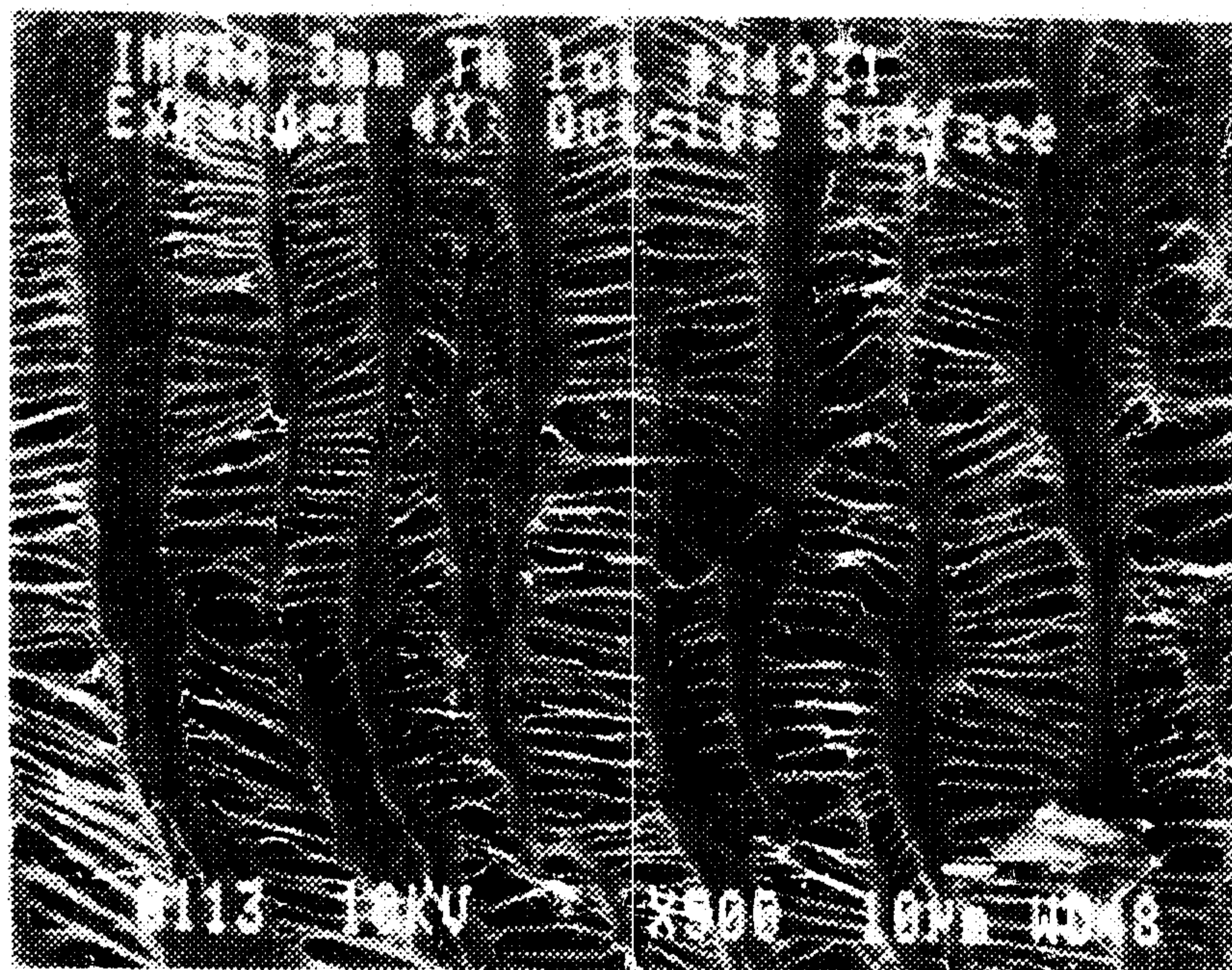

Fig. 7D

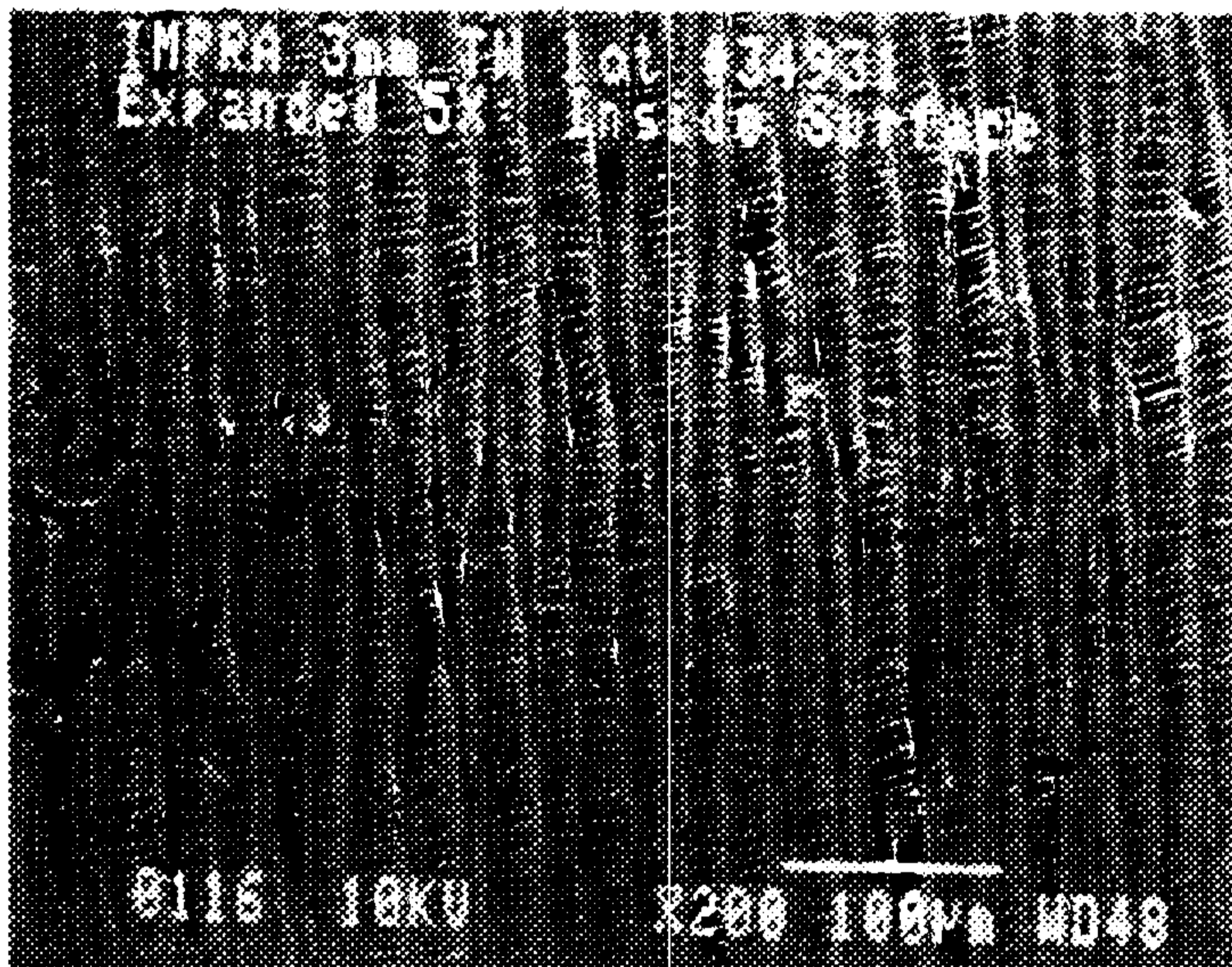

Fig. 8A

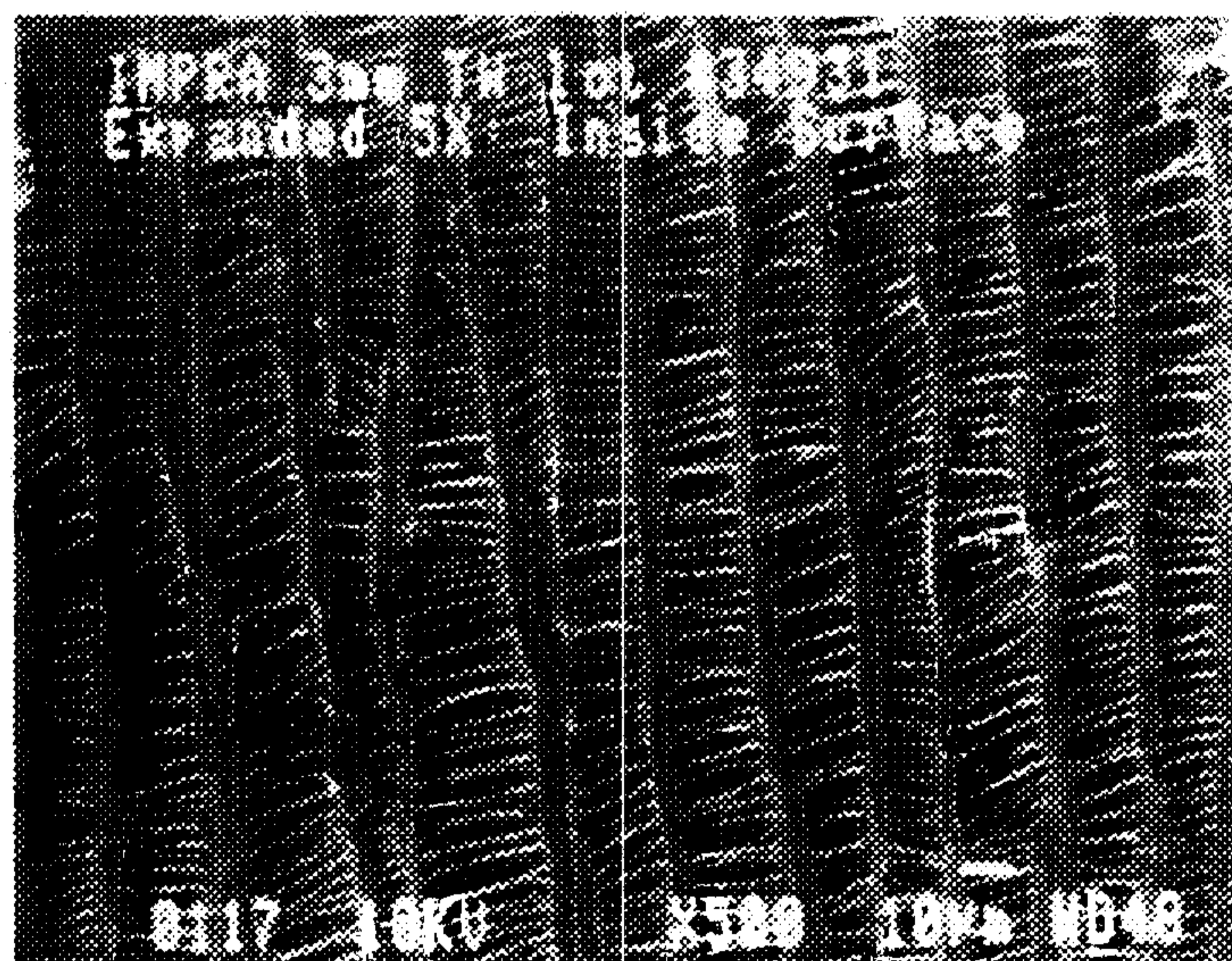

Fig. 8B

10/42

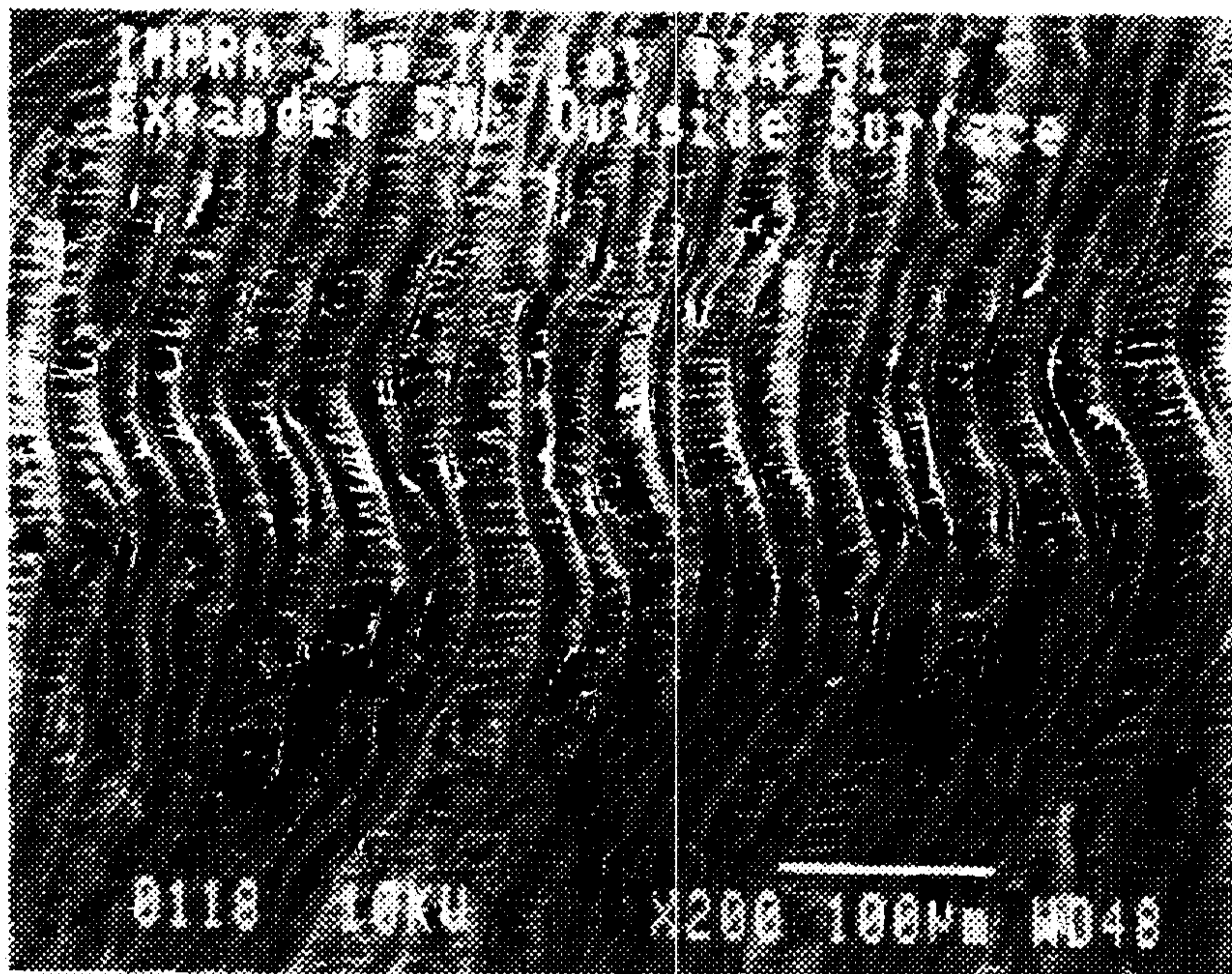

Fig. 8C

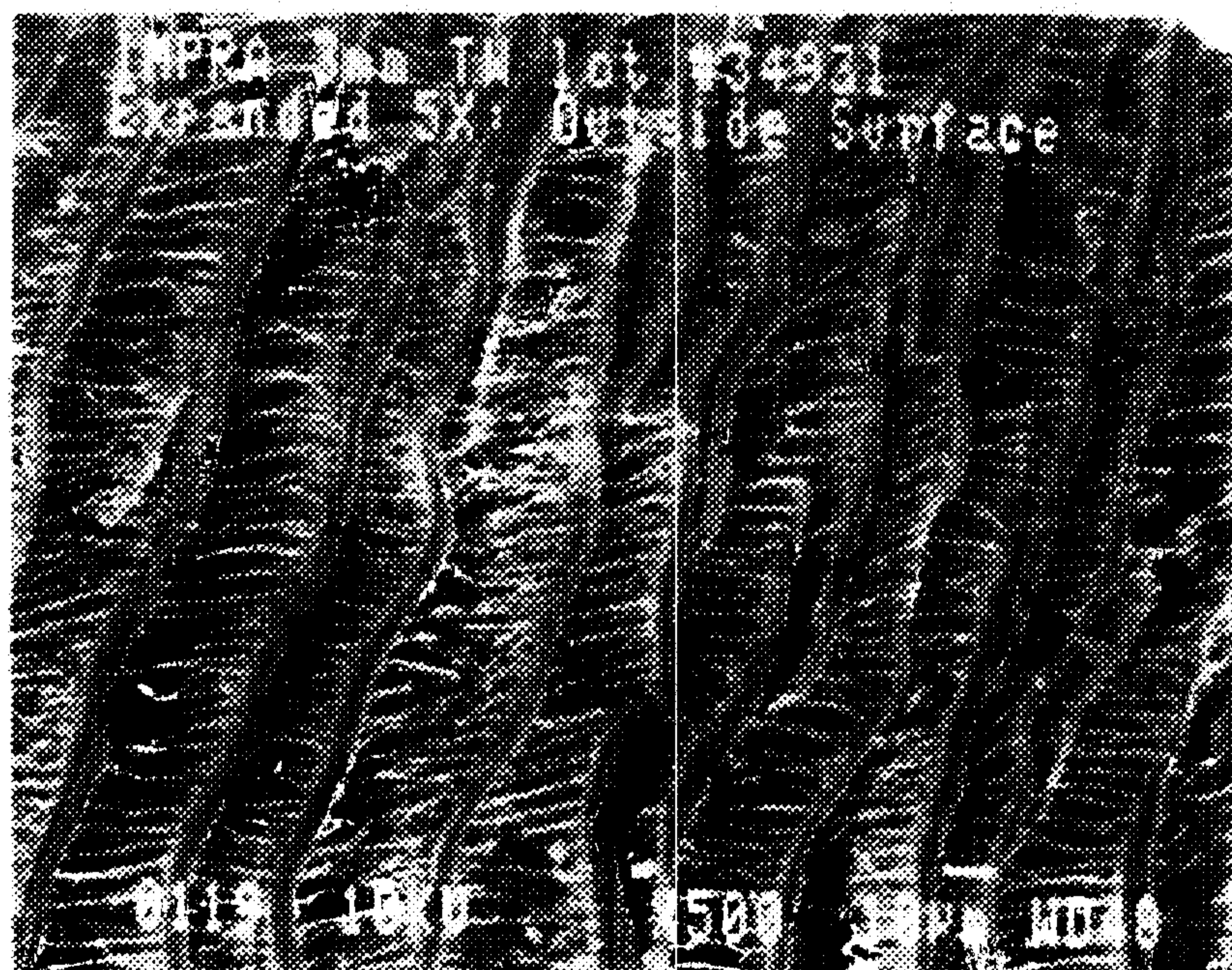

Fig. 8D

11/42

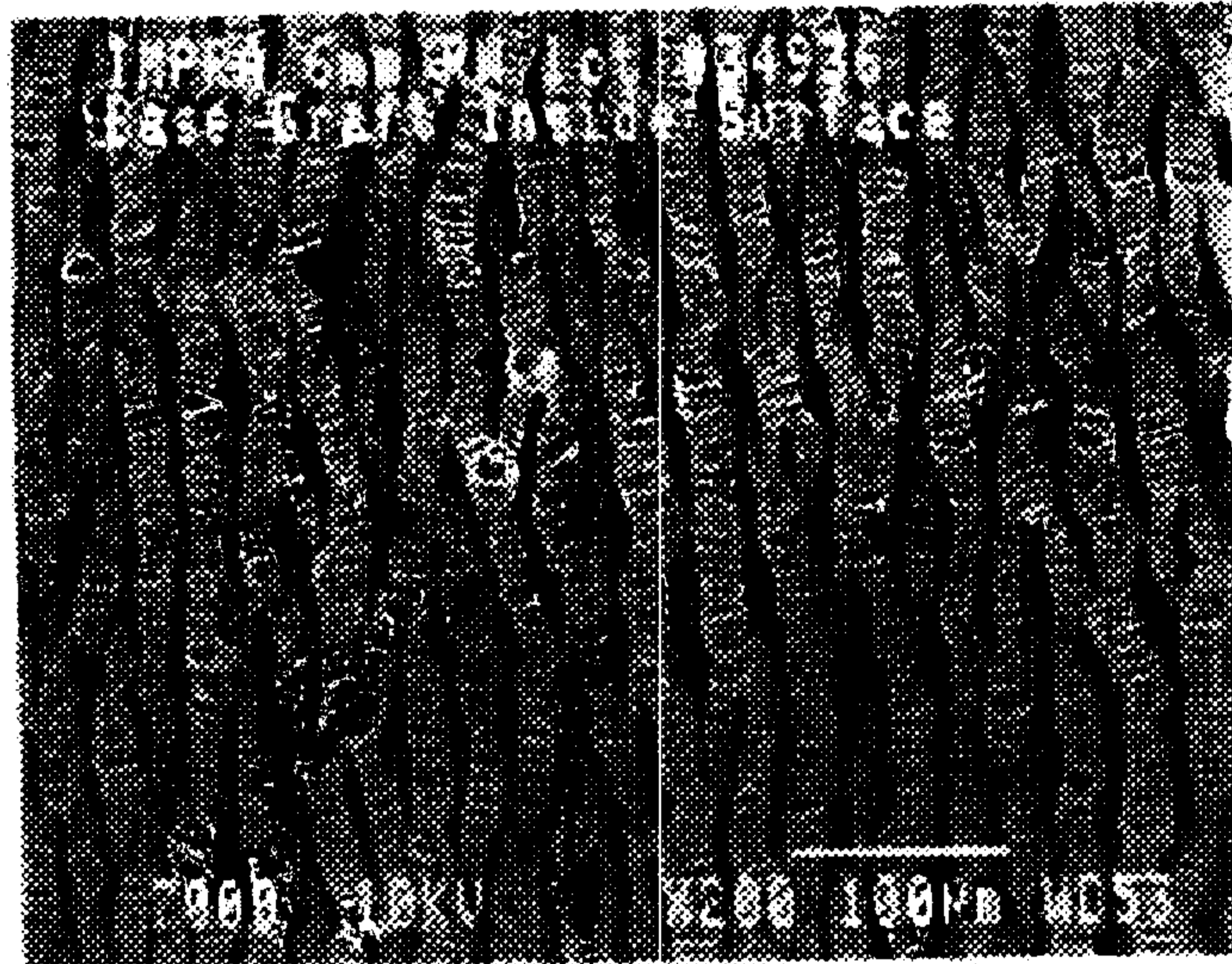

Fig. 9A

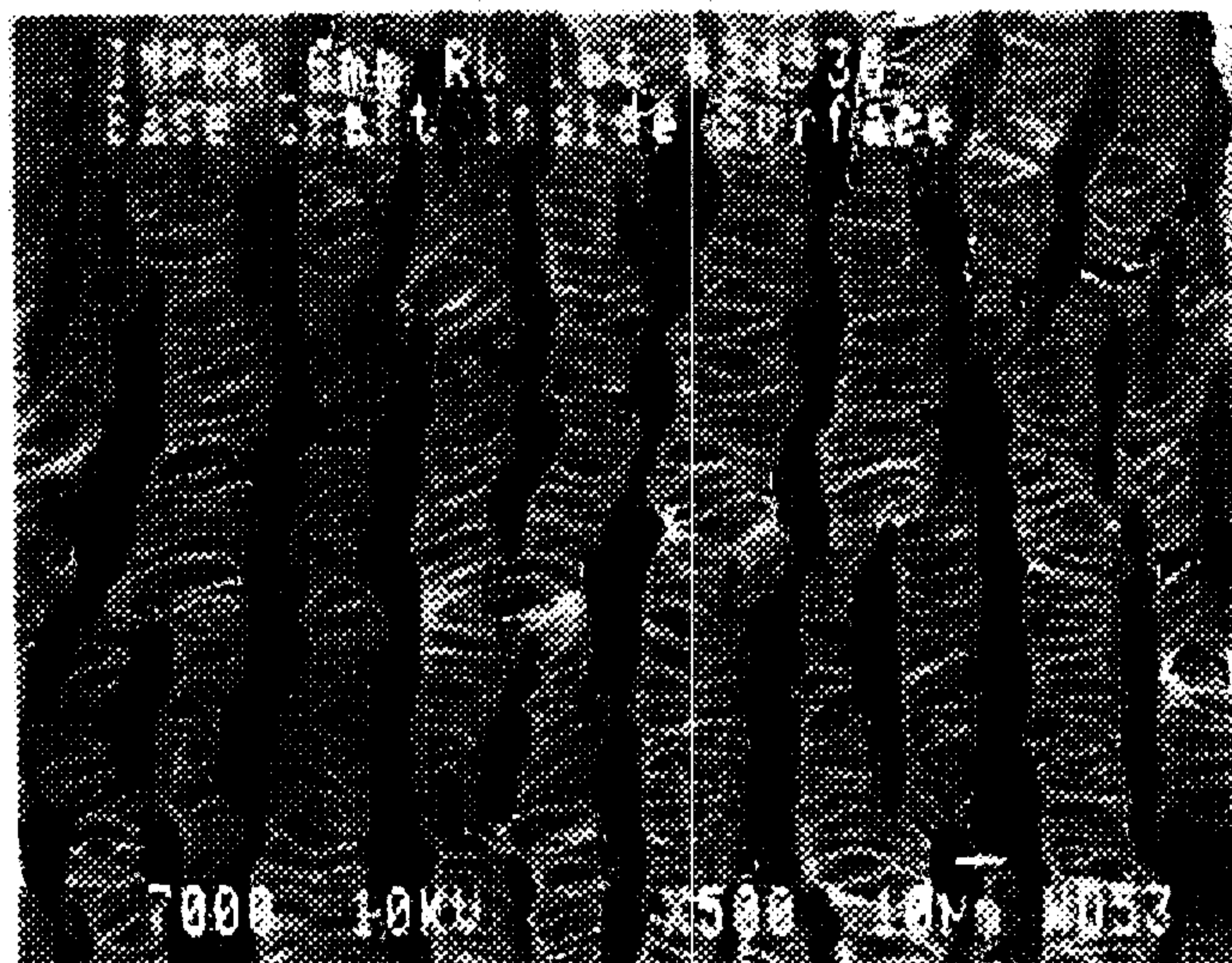

Fig. 9B

12/42

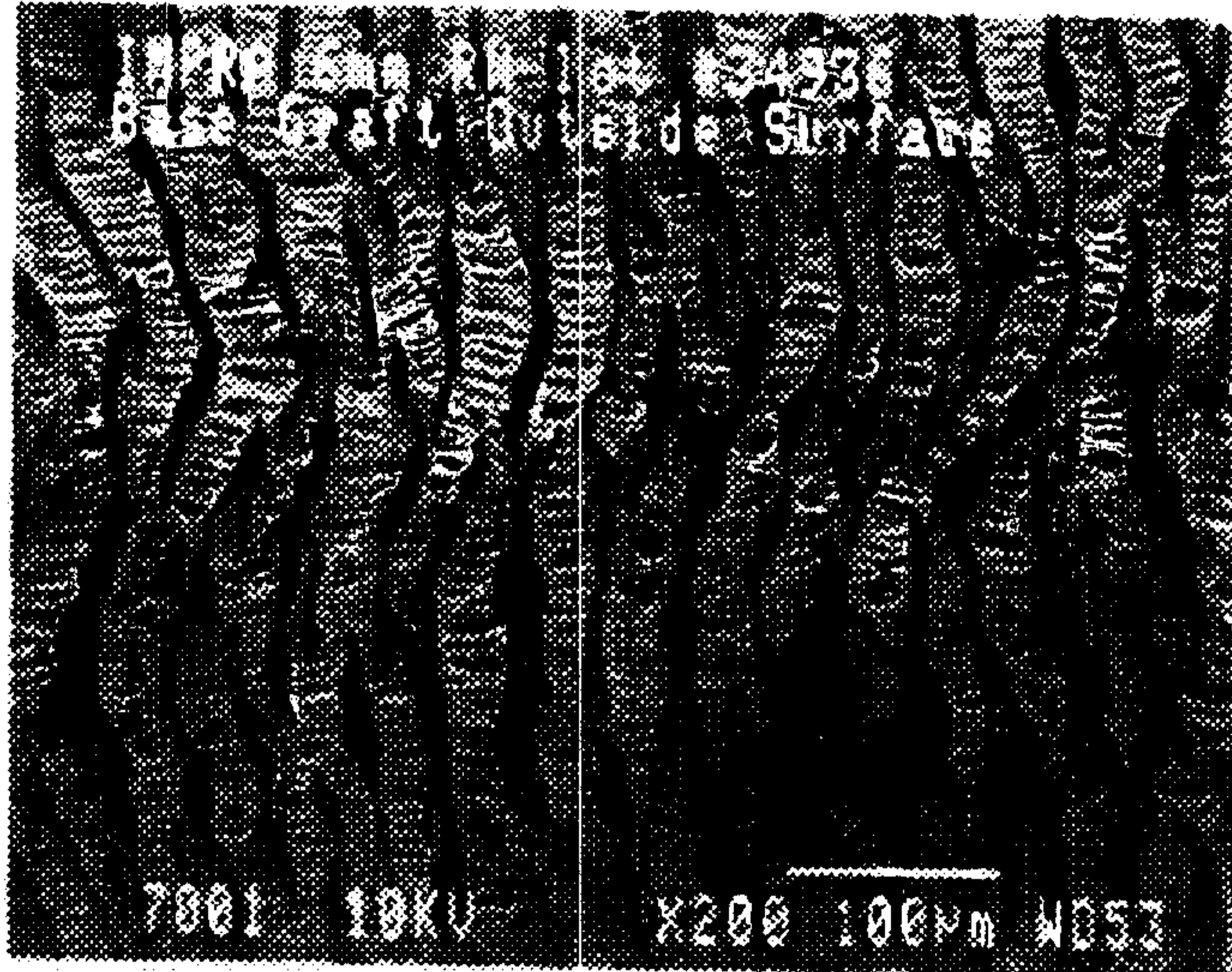

Fig. 9C

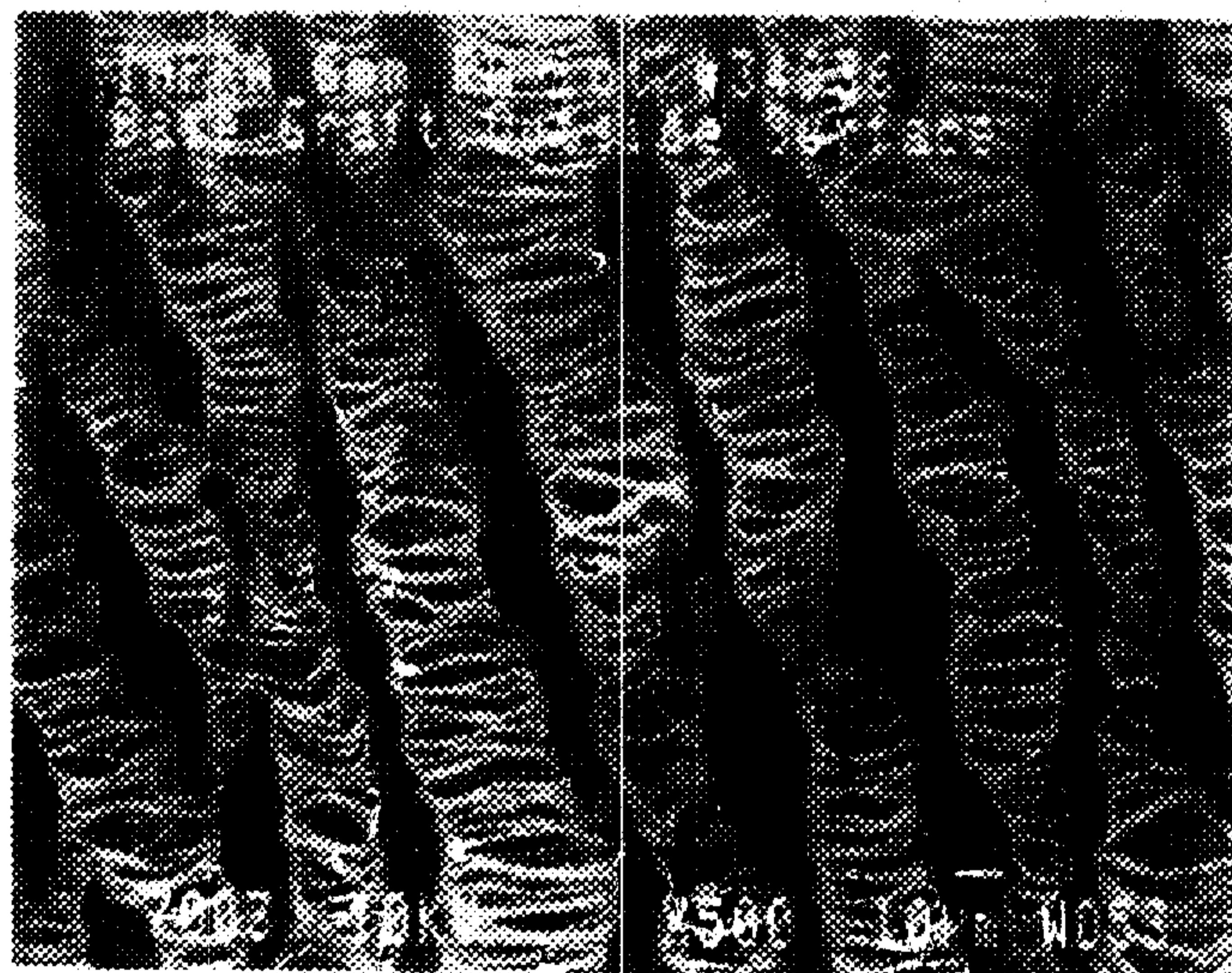

Fig. 9D

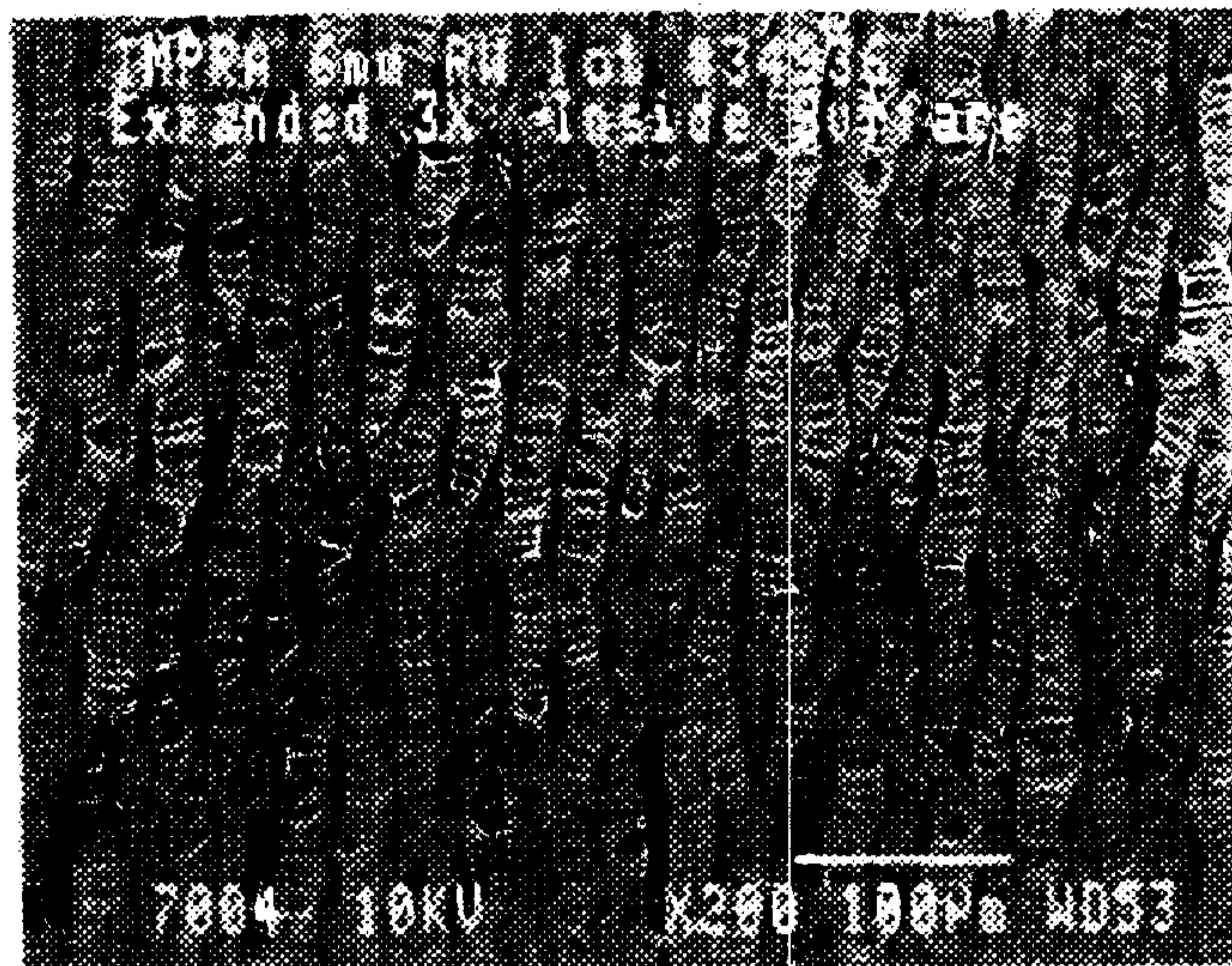

Fig. 10A



Fig. 10B



Fig. 10C

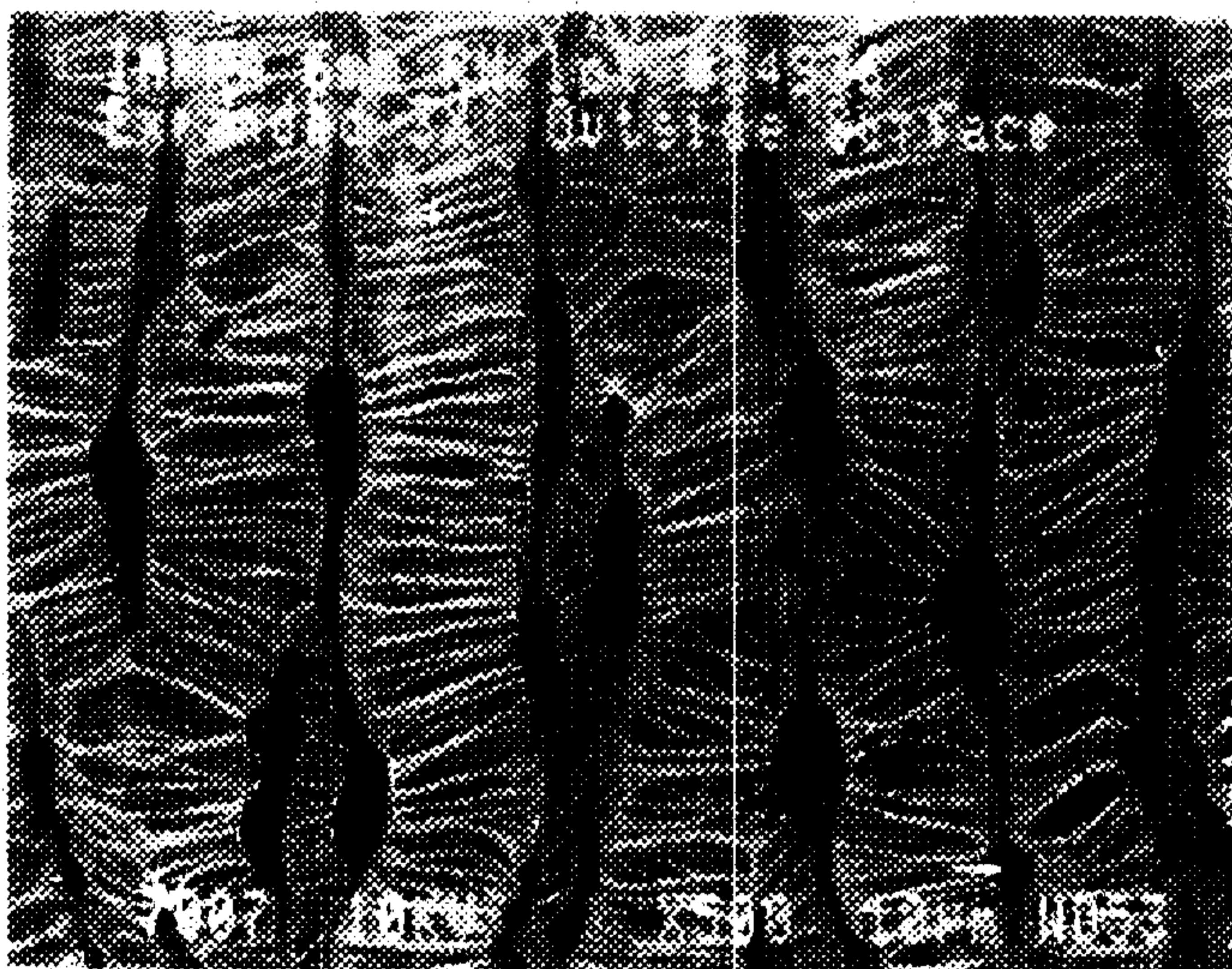

Fig. 10D

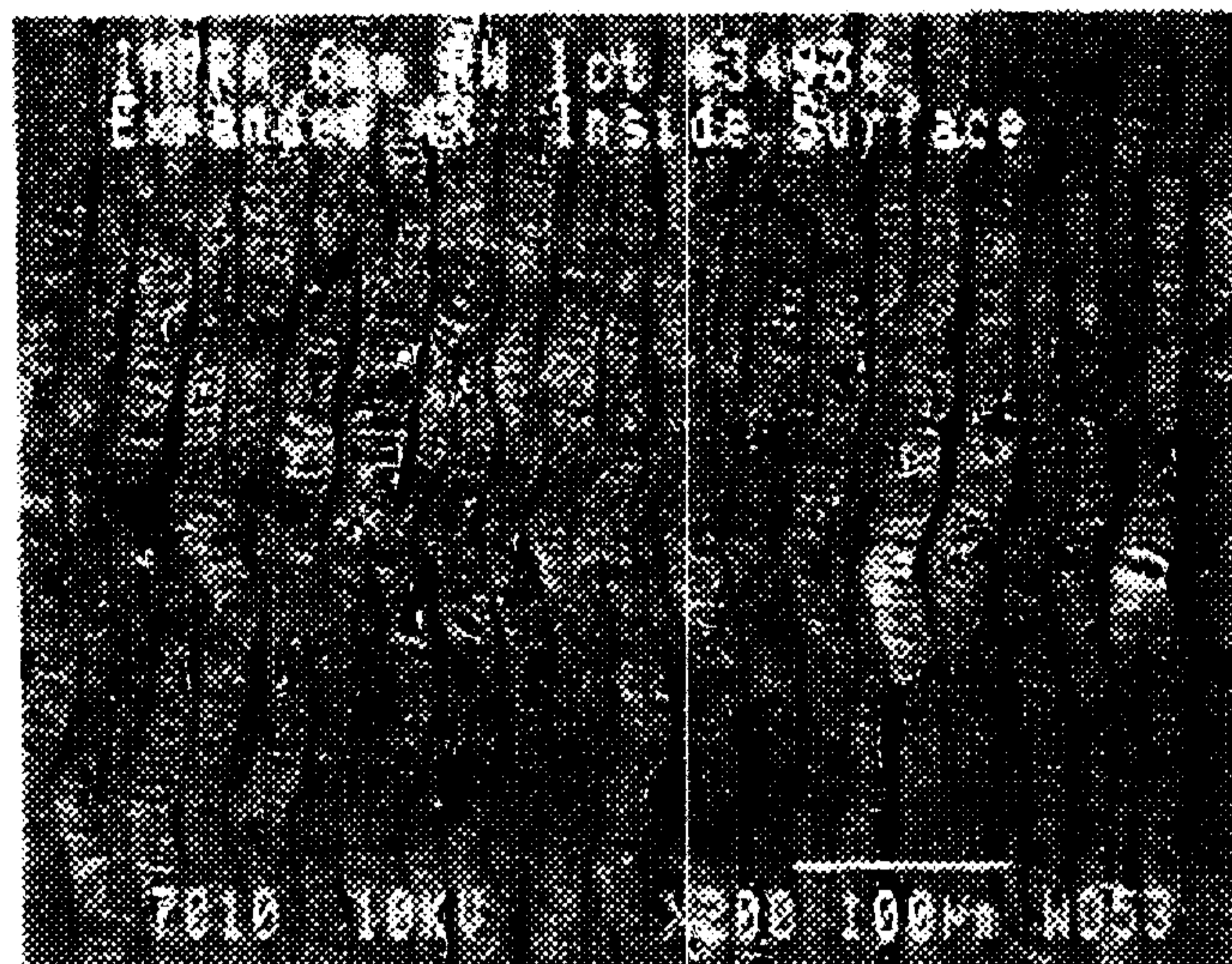

Fig. 11A

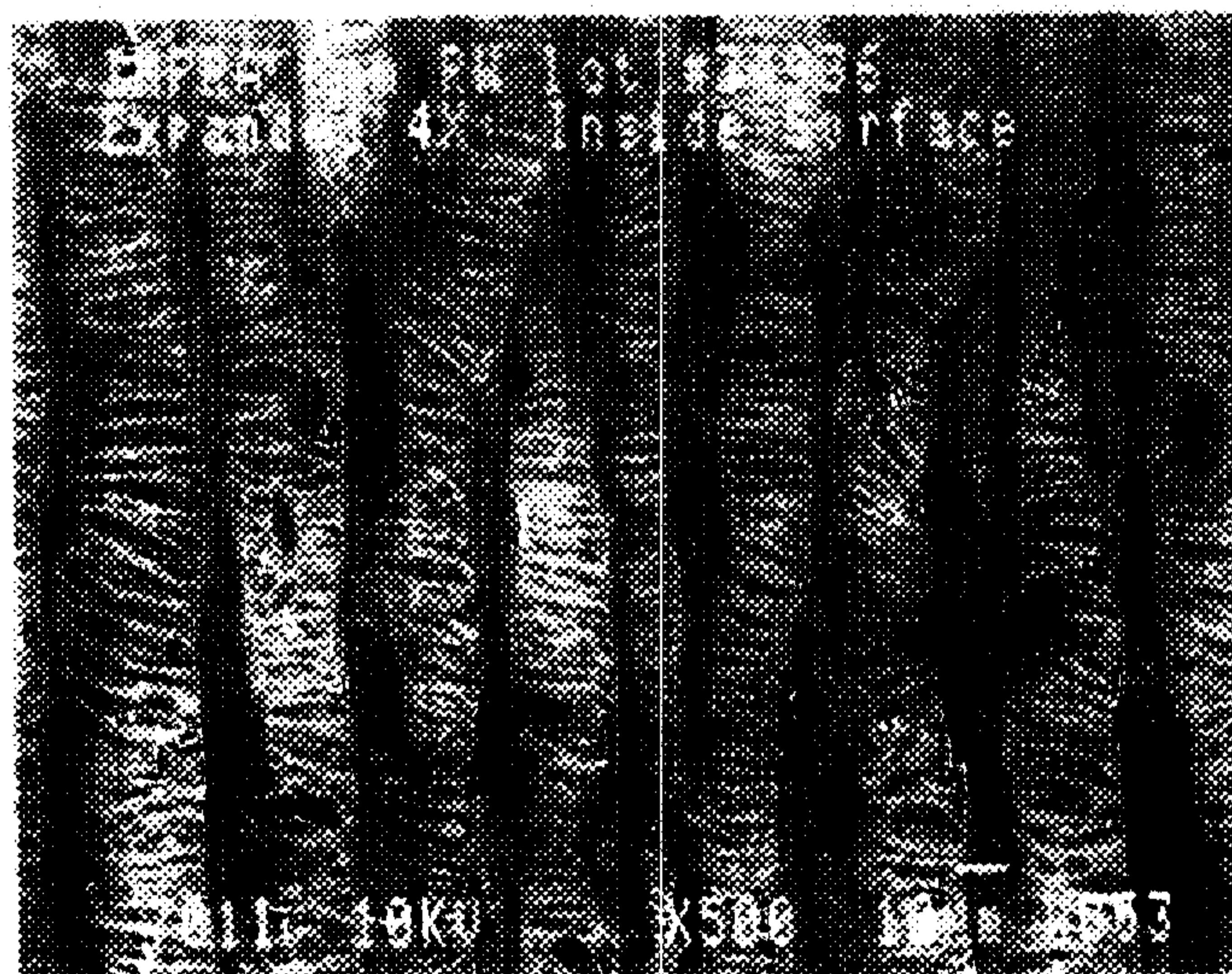

Fig. 11B

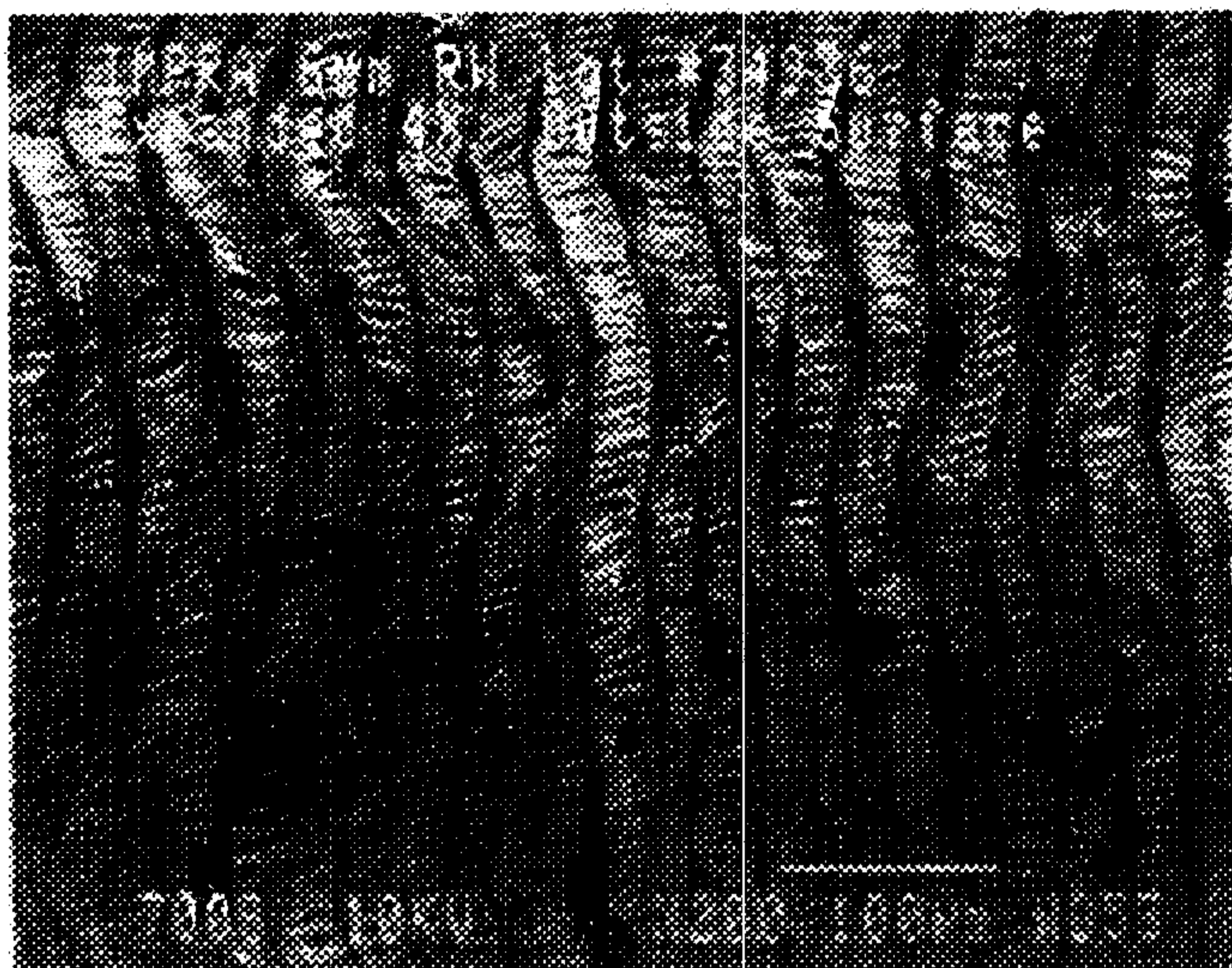

Fig. IIC

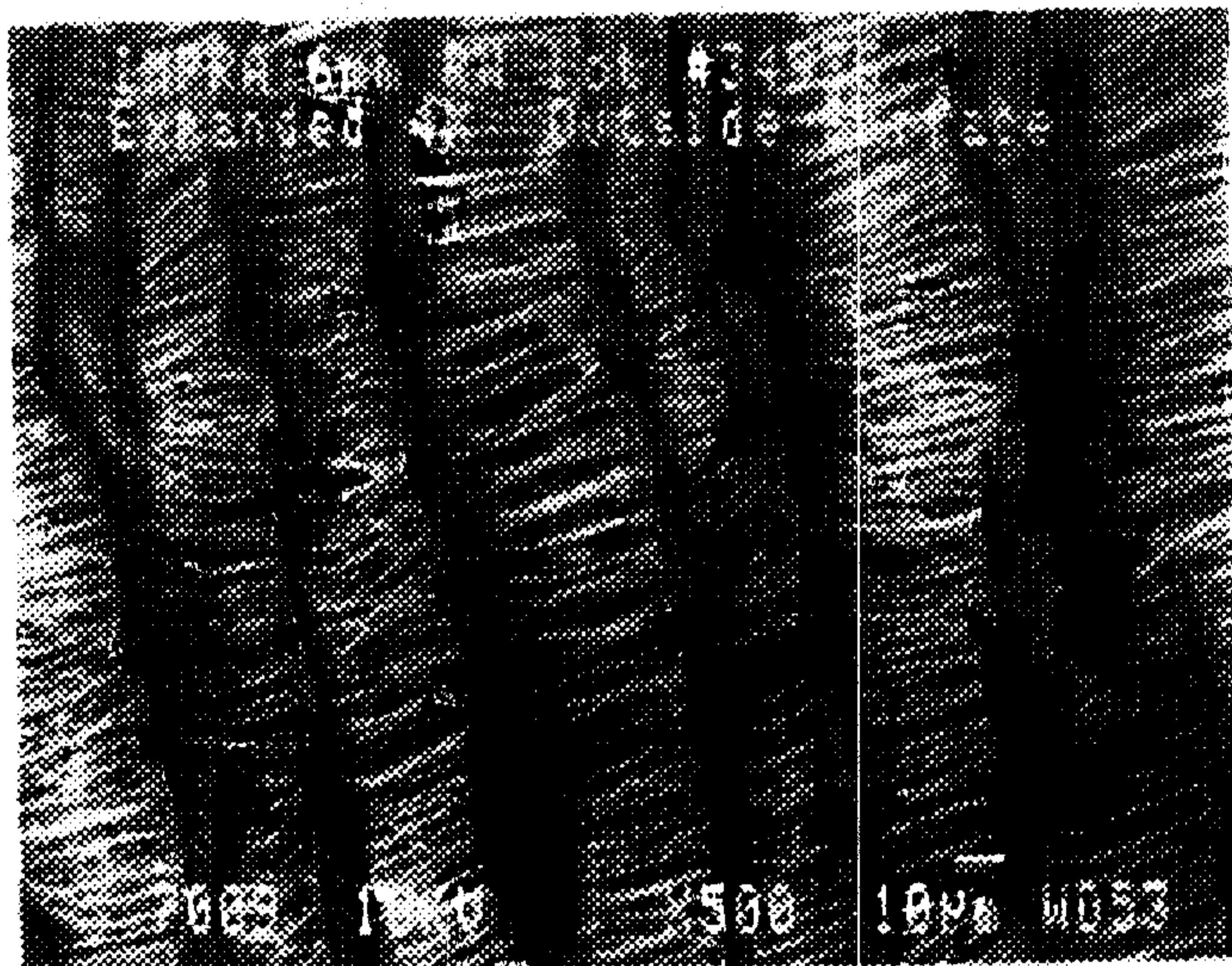

Fig. IID

17/42

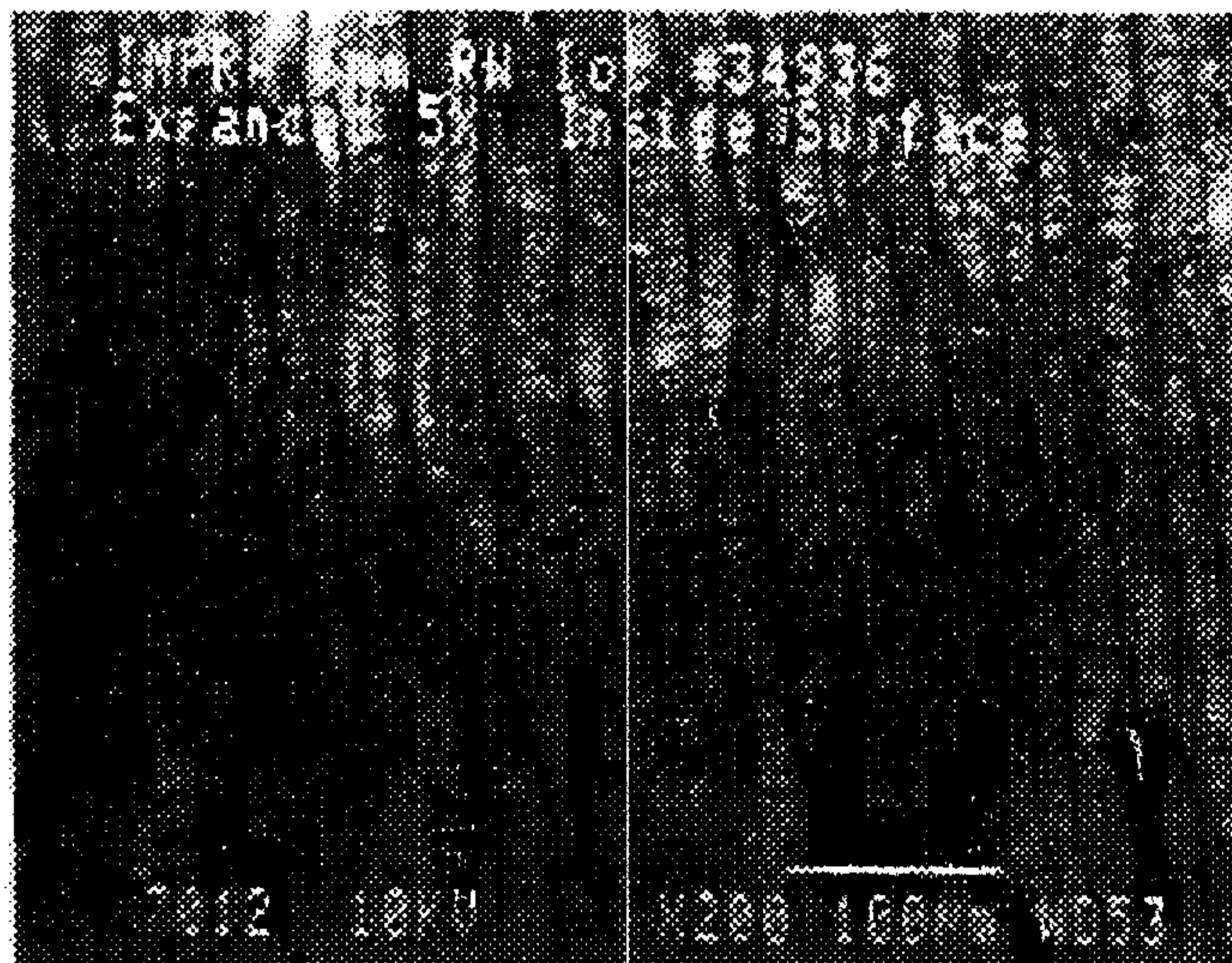

Fig. 12A

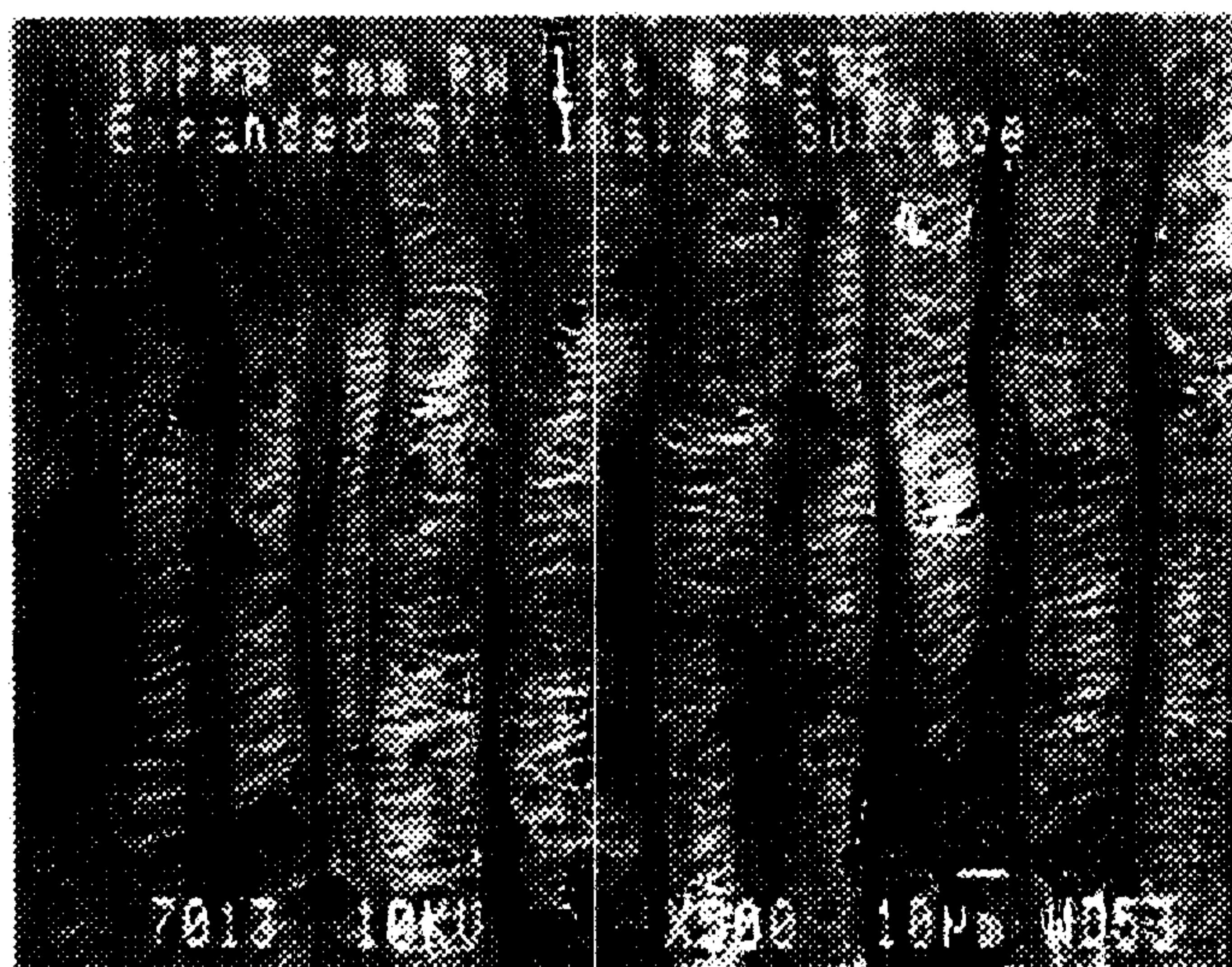

Fig. 12B

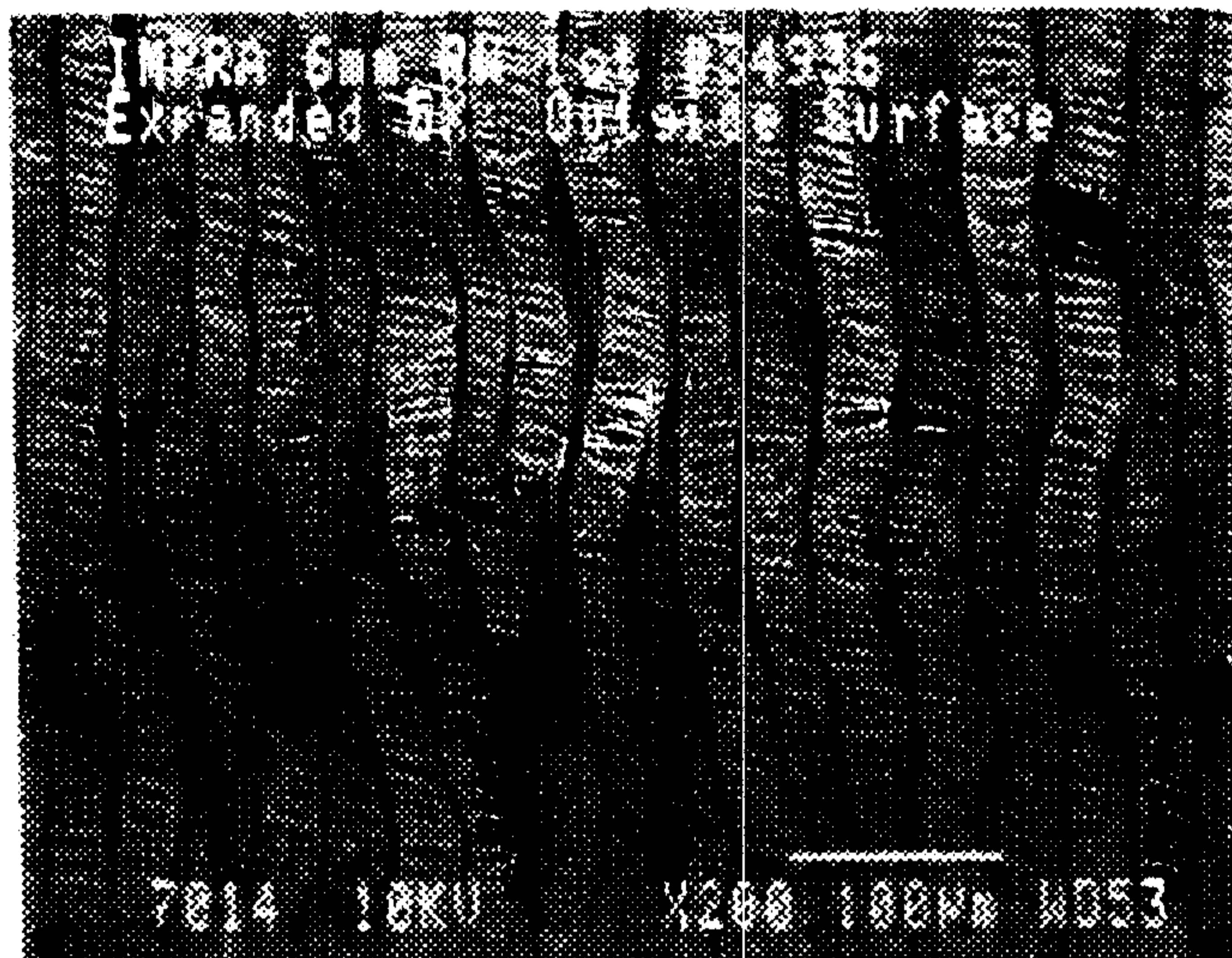

Fig. 12C

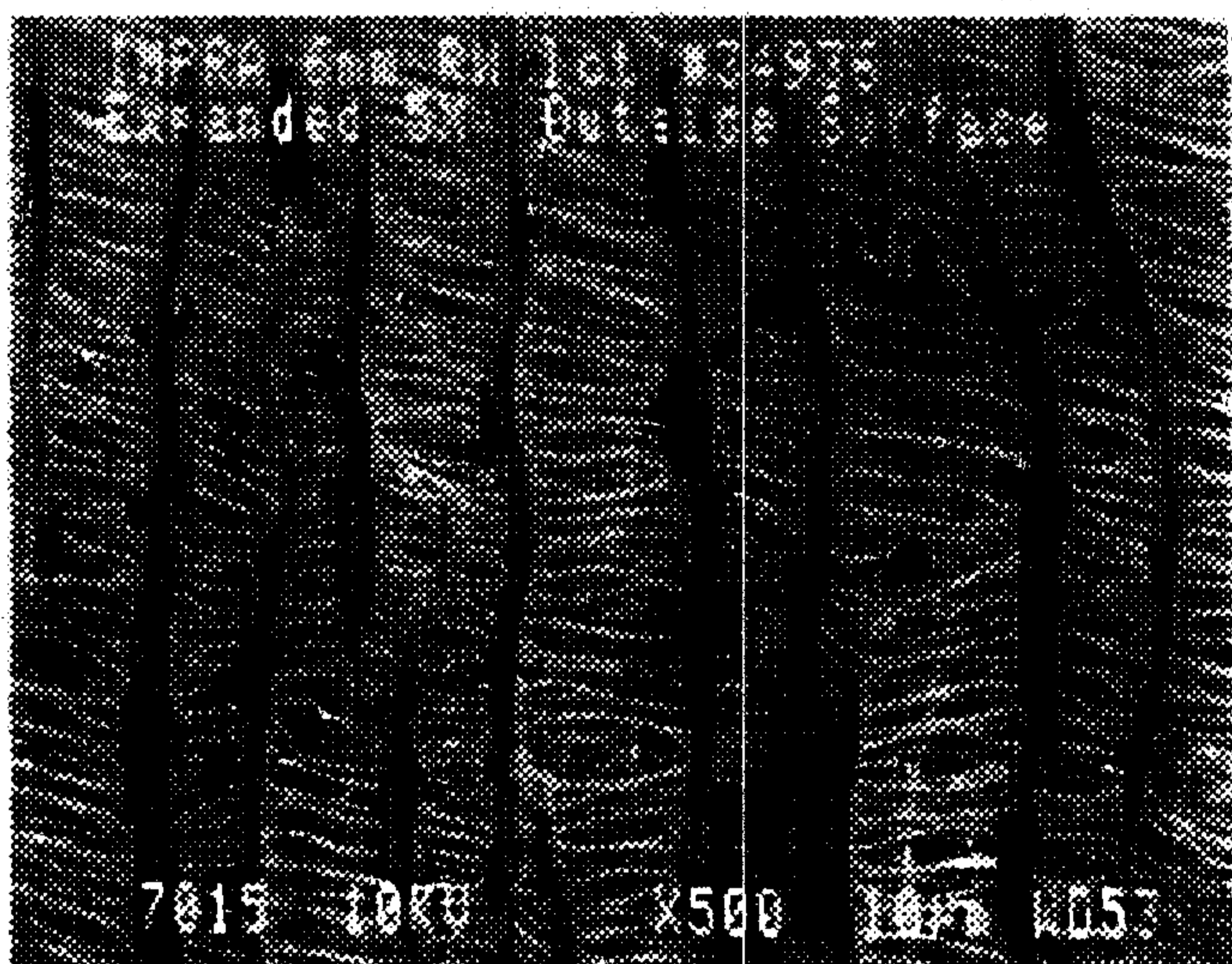

Fig. 12D

19/42

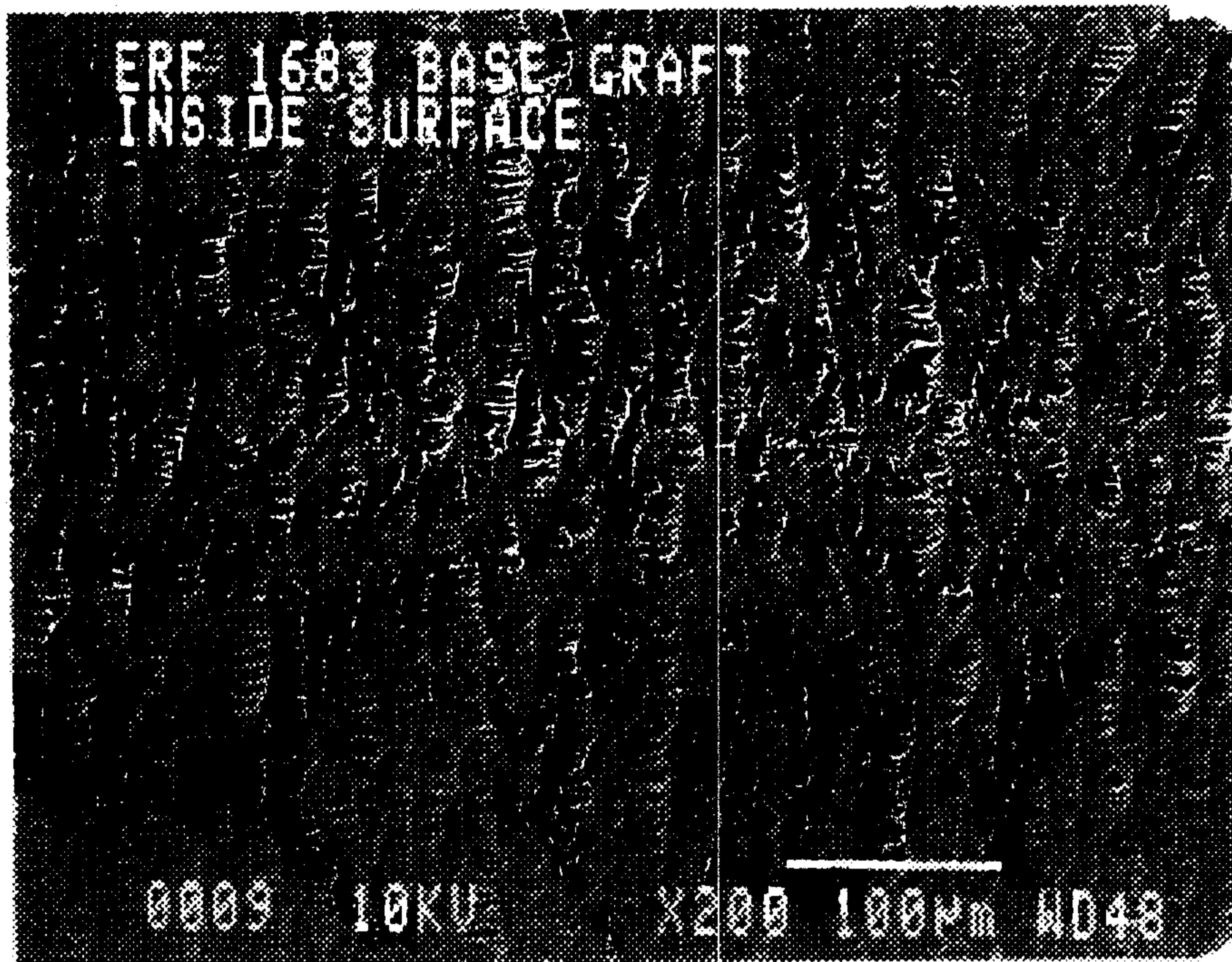

Fig. 13A

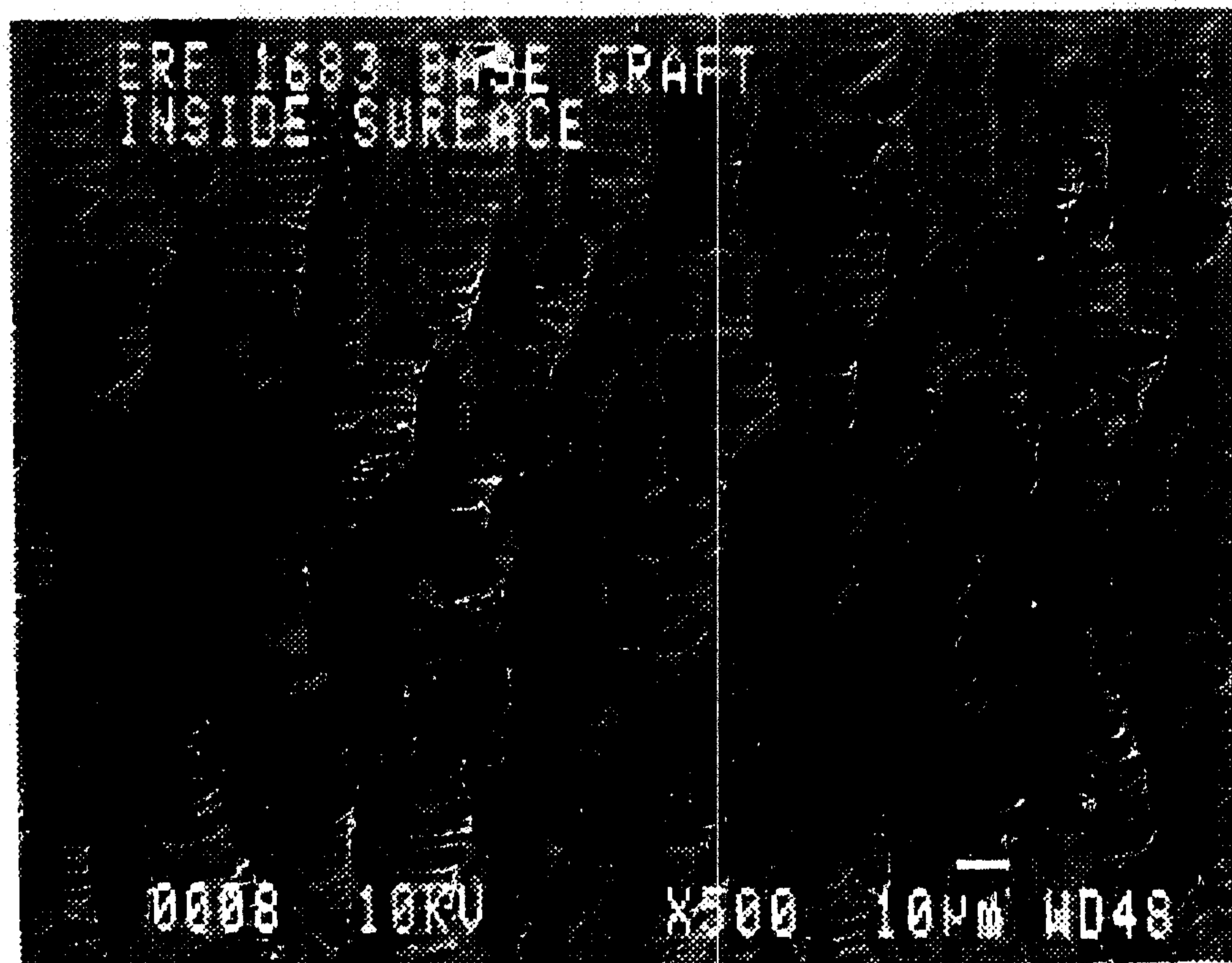

Fig. 13B
SUBSTITUTE SHEET (RULE 26)

20/42

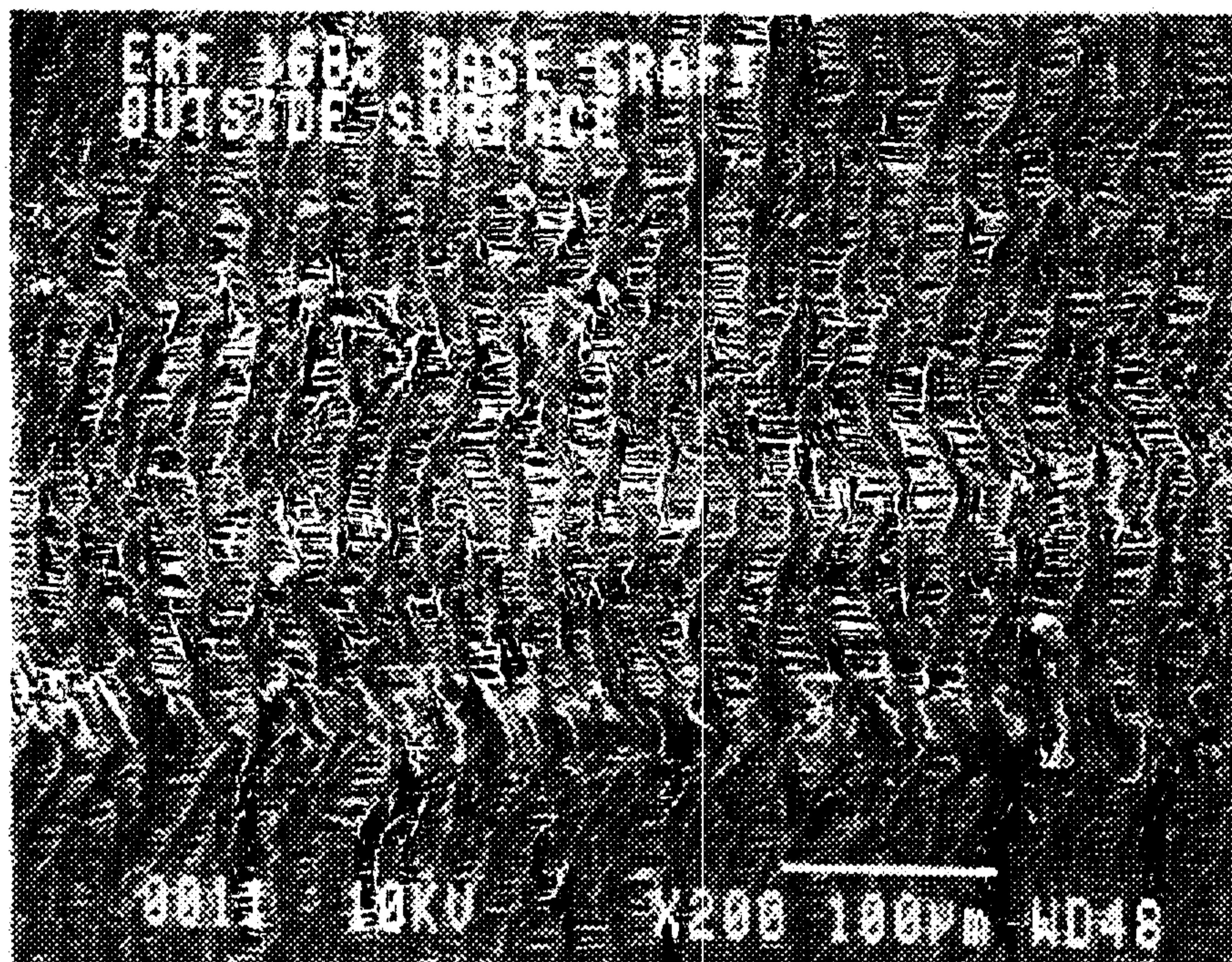

Fig. 13C



Fig. 13D

21/42



Fig. 14A

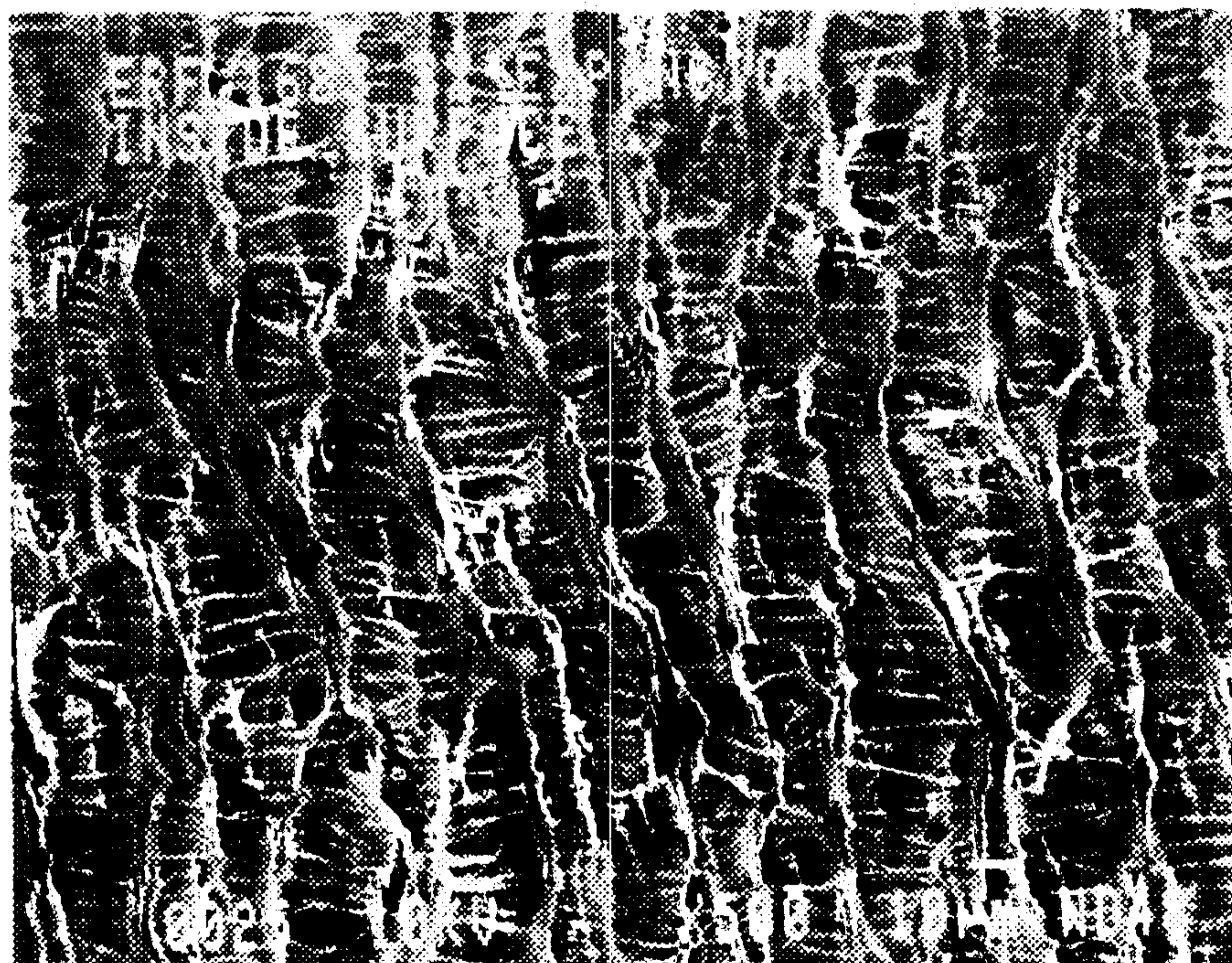

Fig. 14B

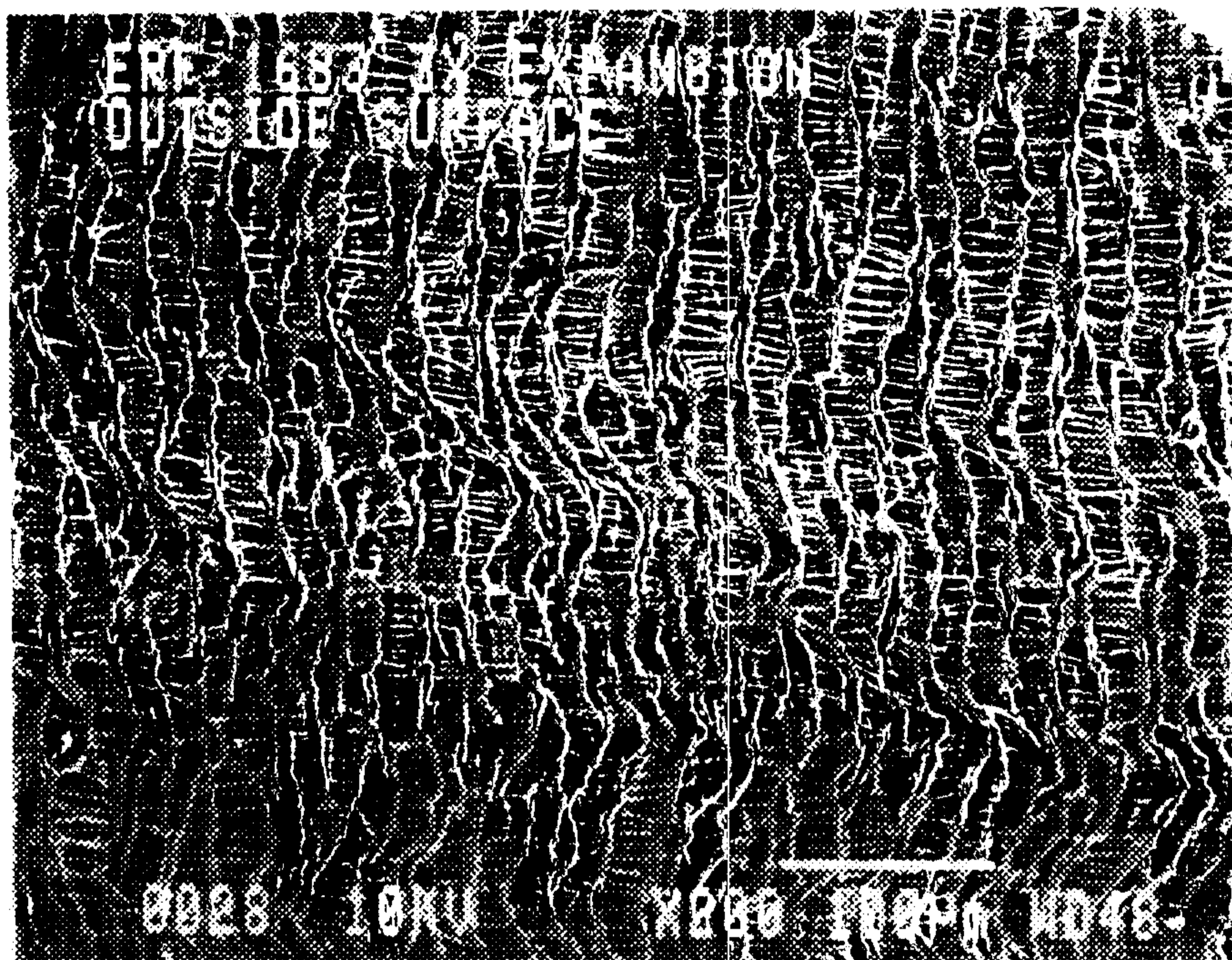

Fig. 14C

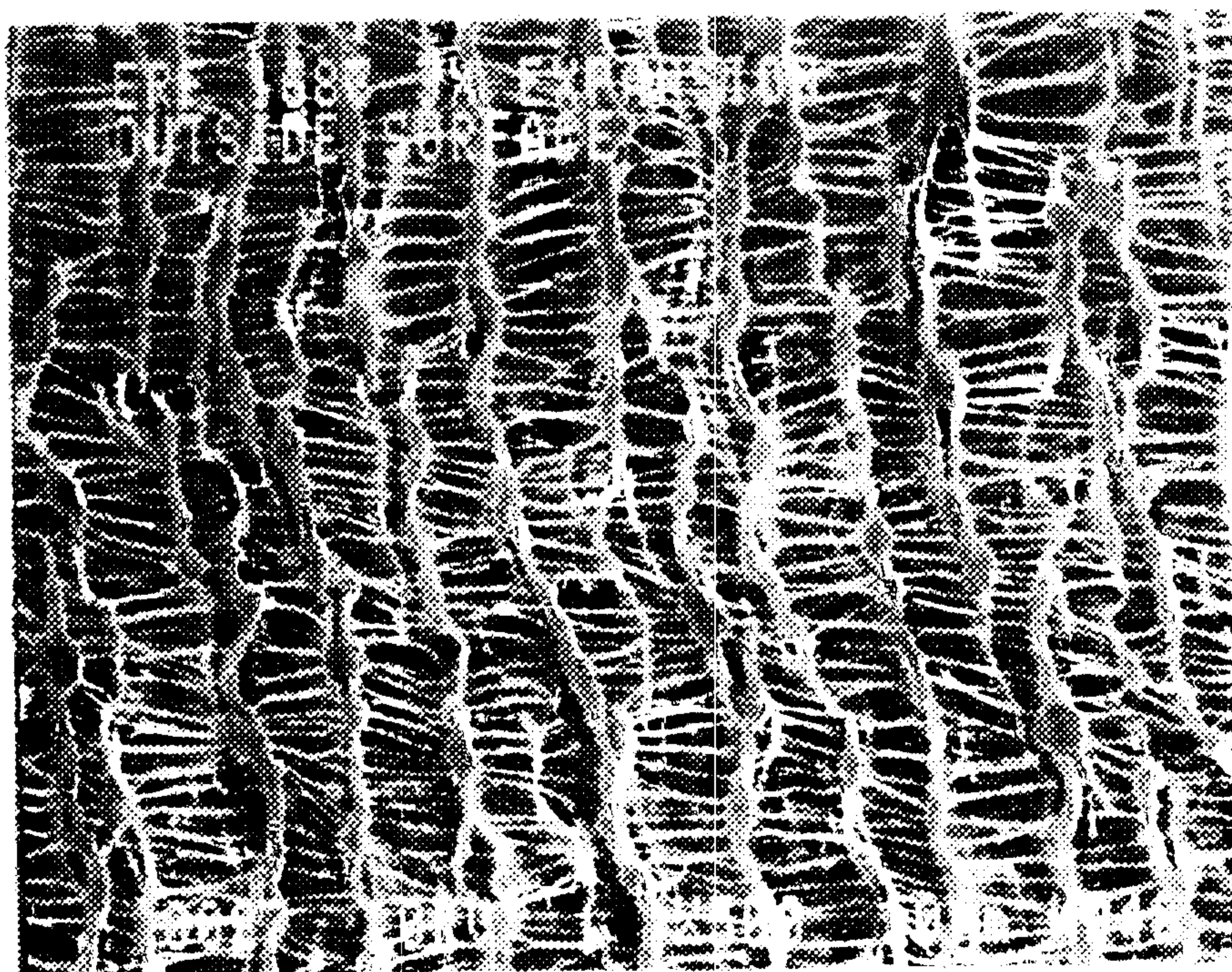

Fig. 14D

23/42

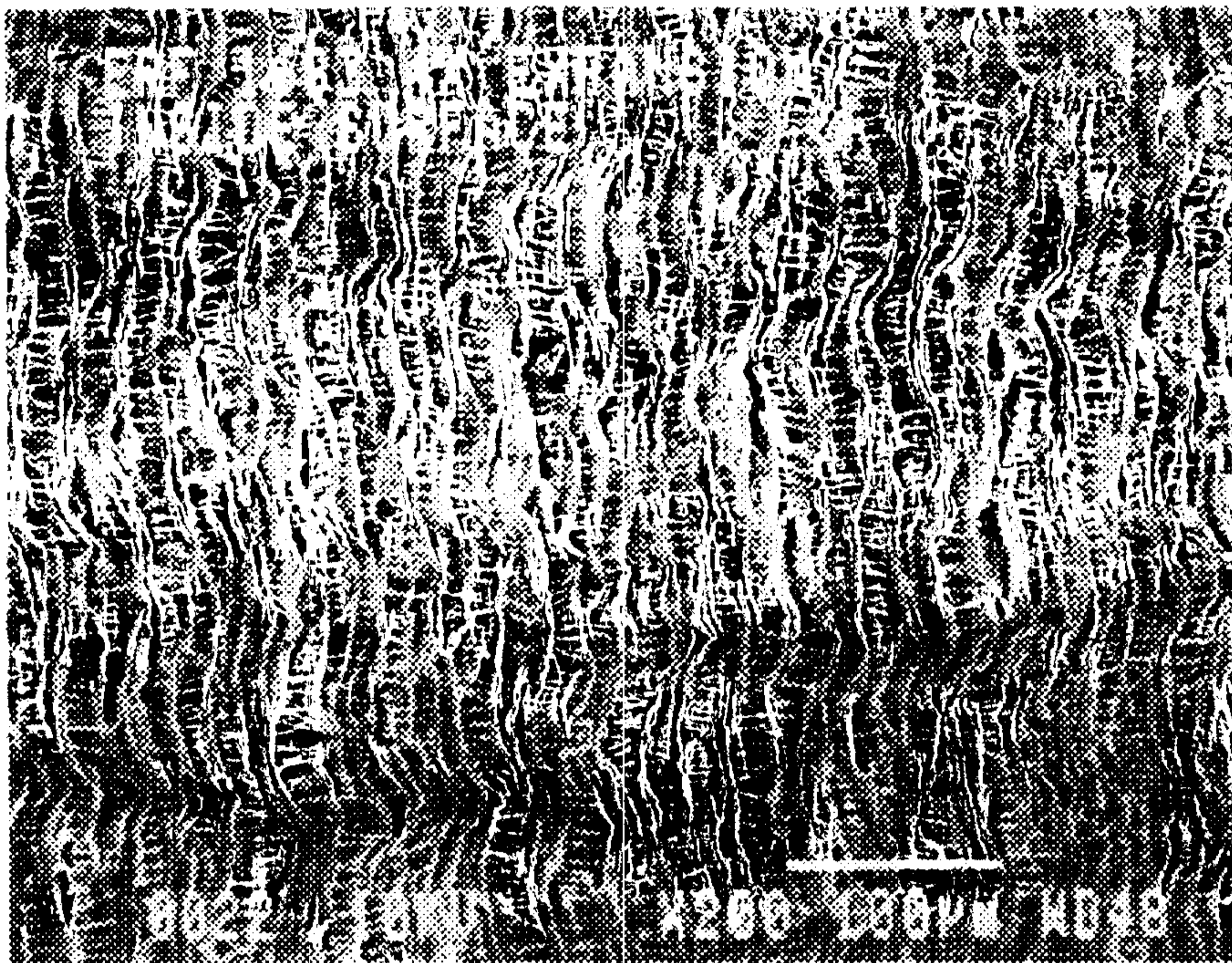

Fig. 15A

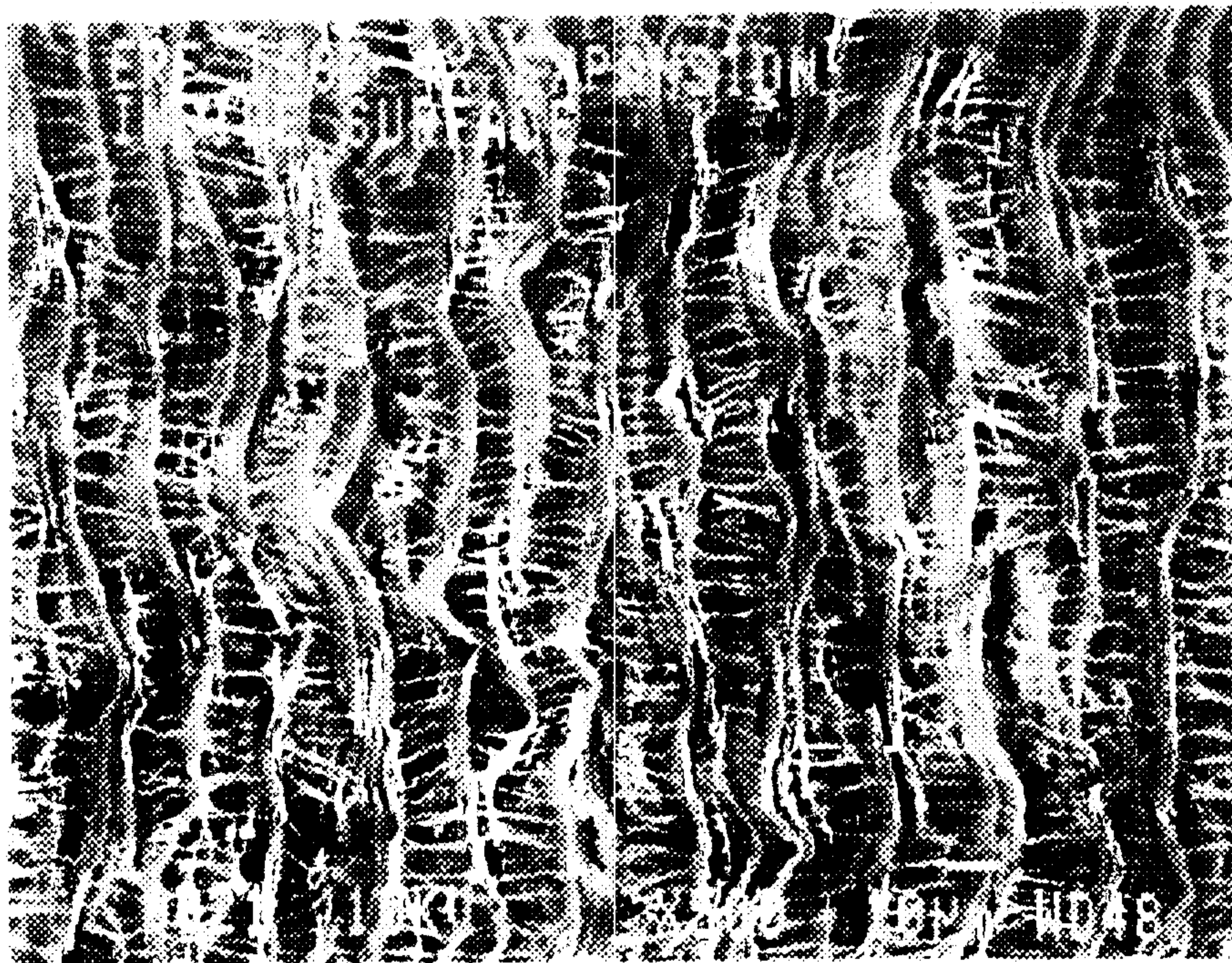

Fig. 15B

24/42

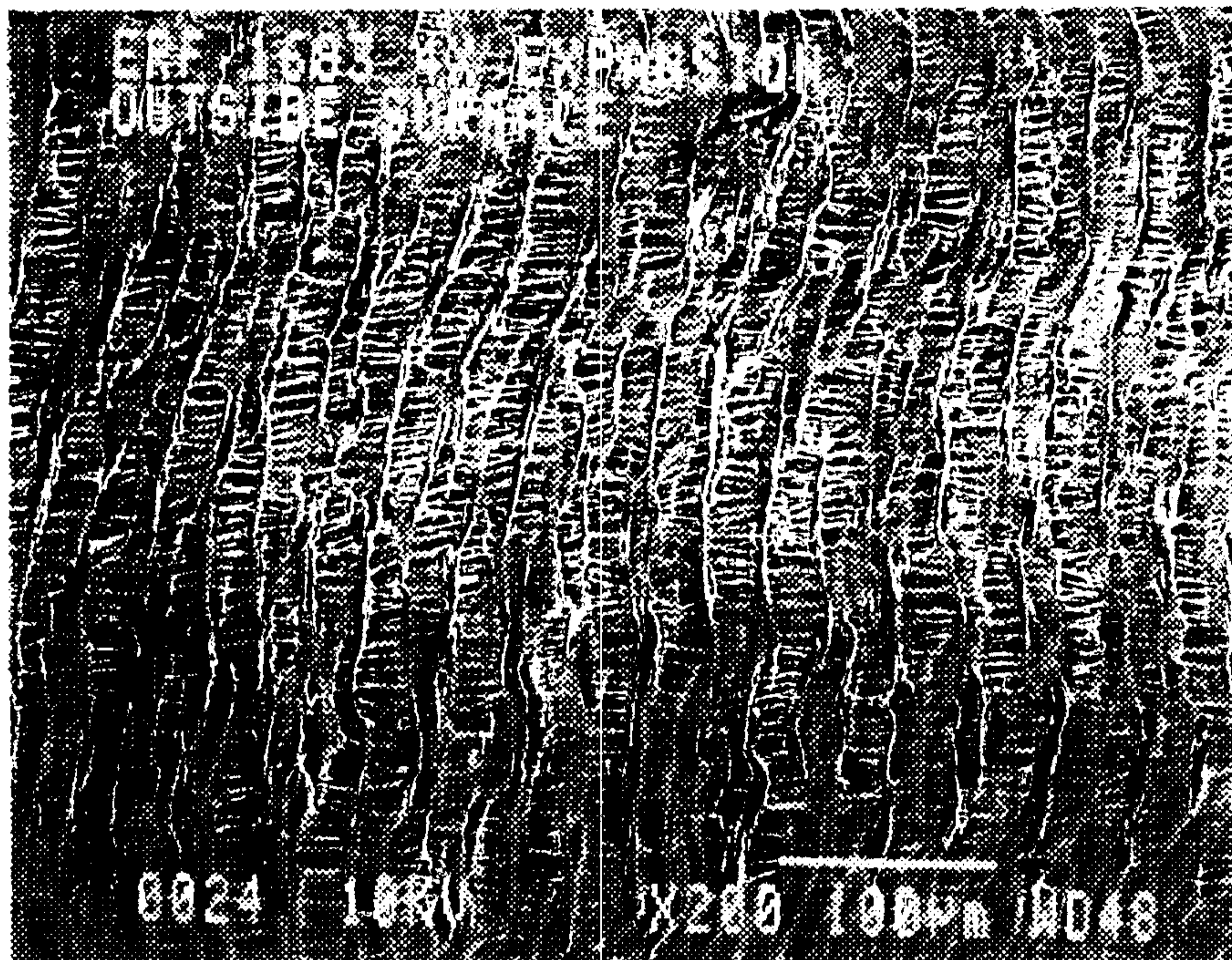

Fig. 15C

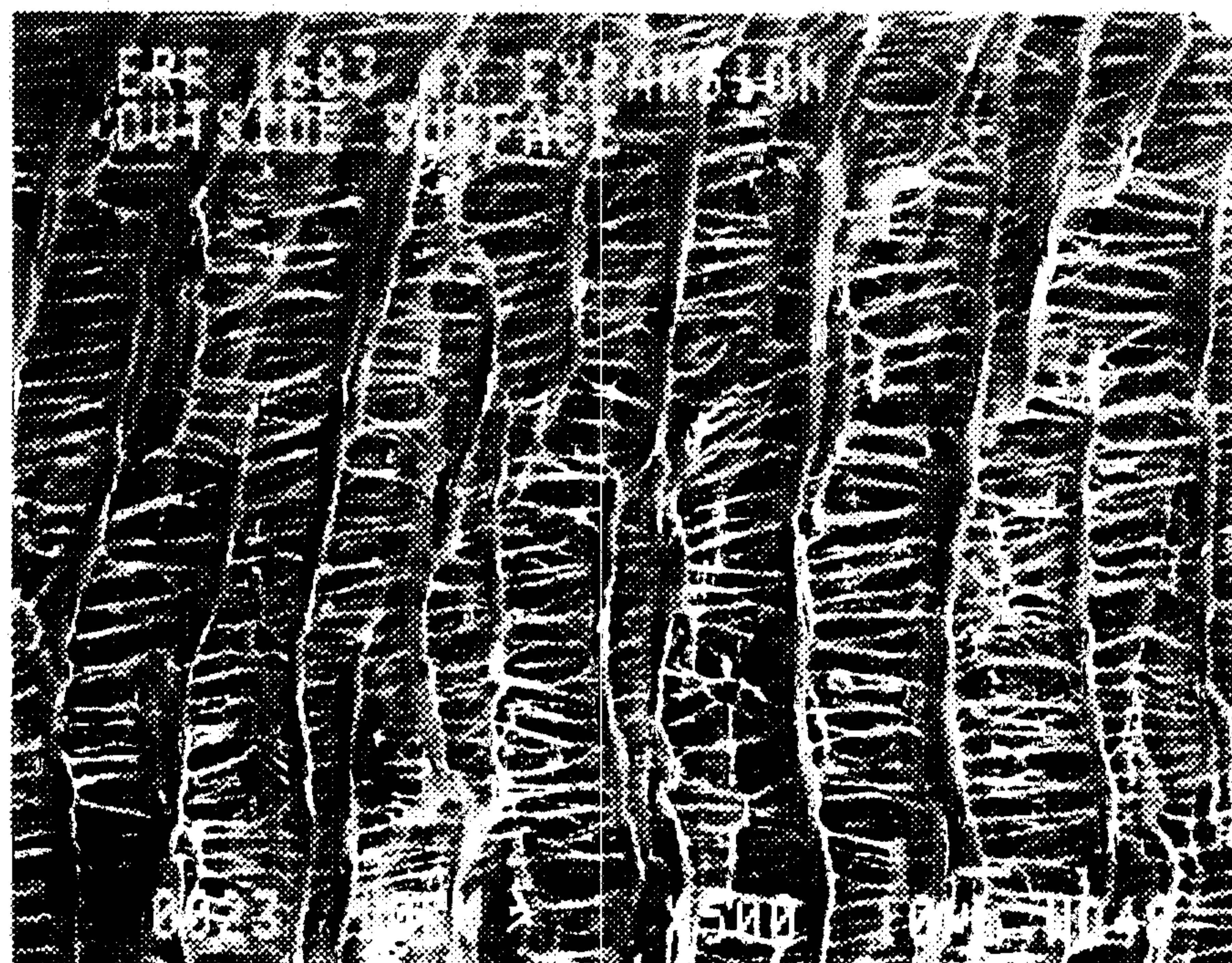

Fig. 15D

SUBSTITUTE SHEET (RULE 26)

25/42

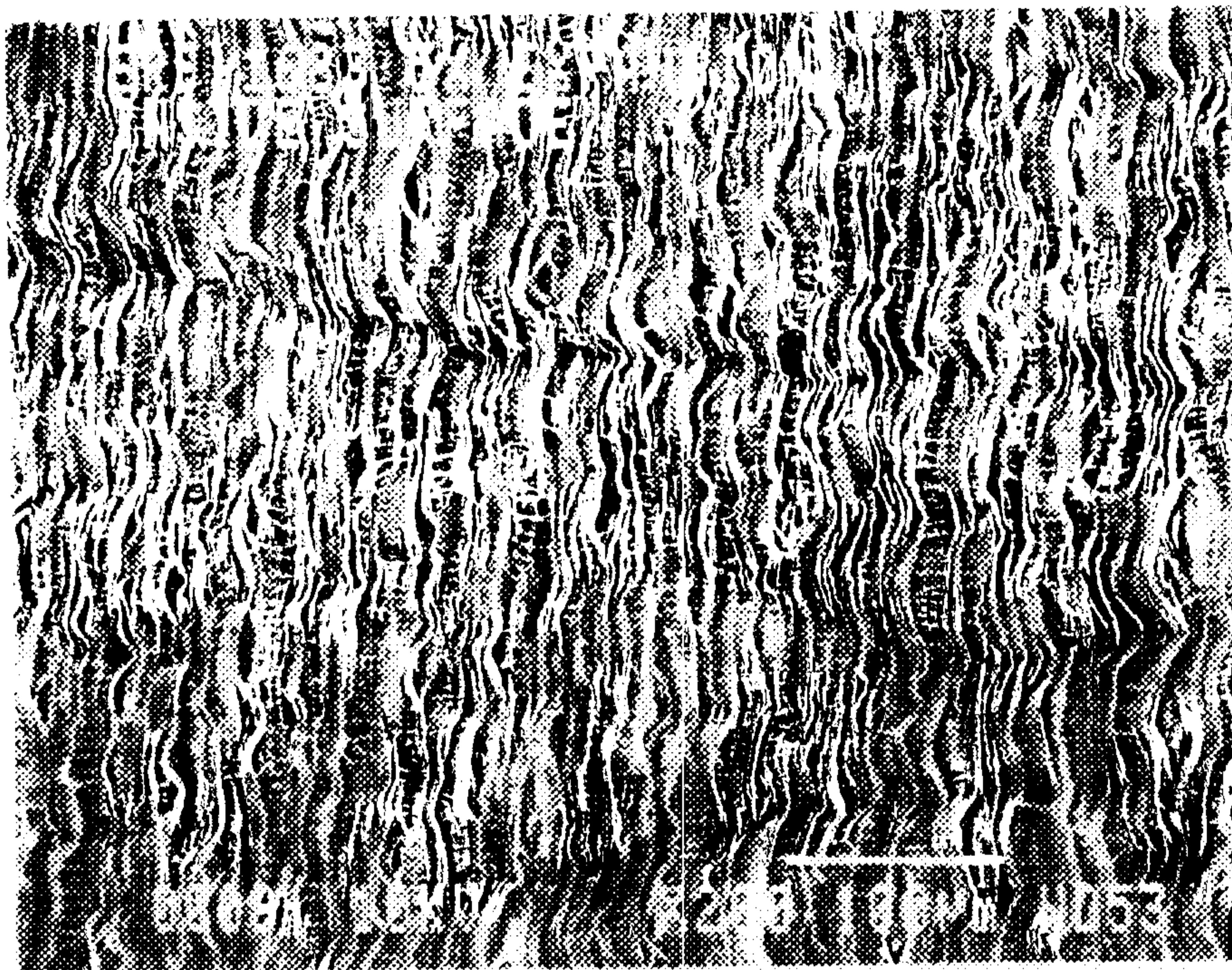

Fig. 16A

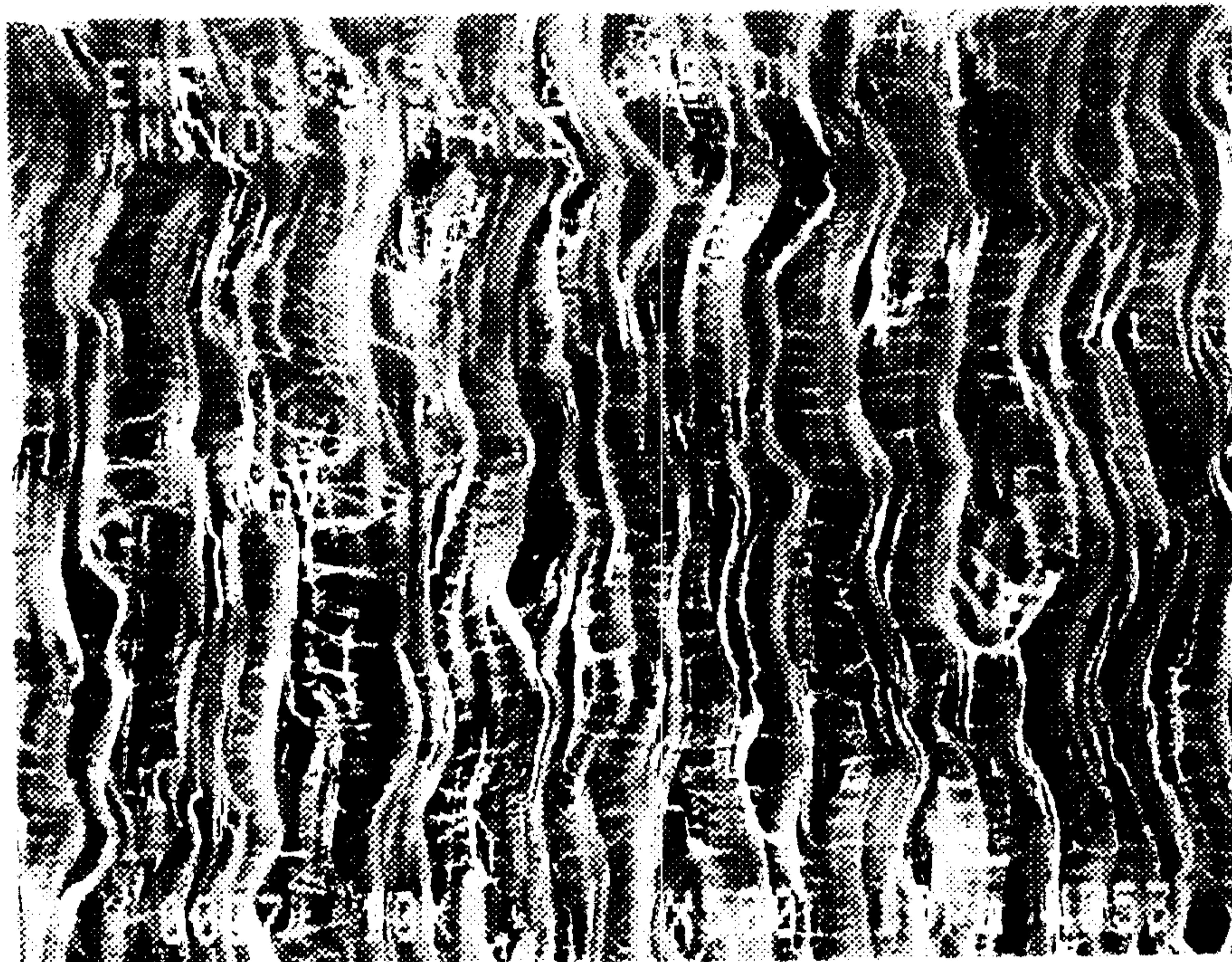

Fig. 16B

SUBSTITUTE SHEET (RULE 26)

26/42

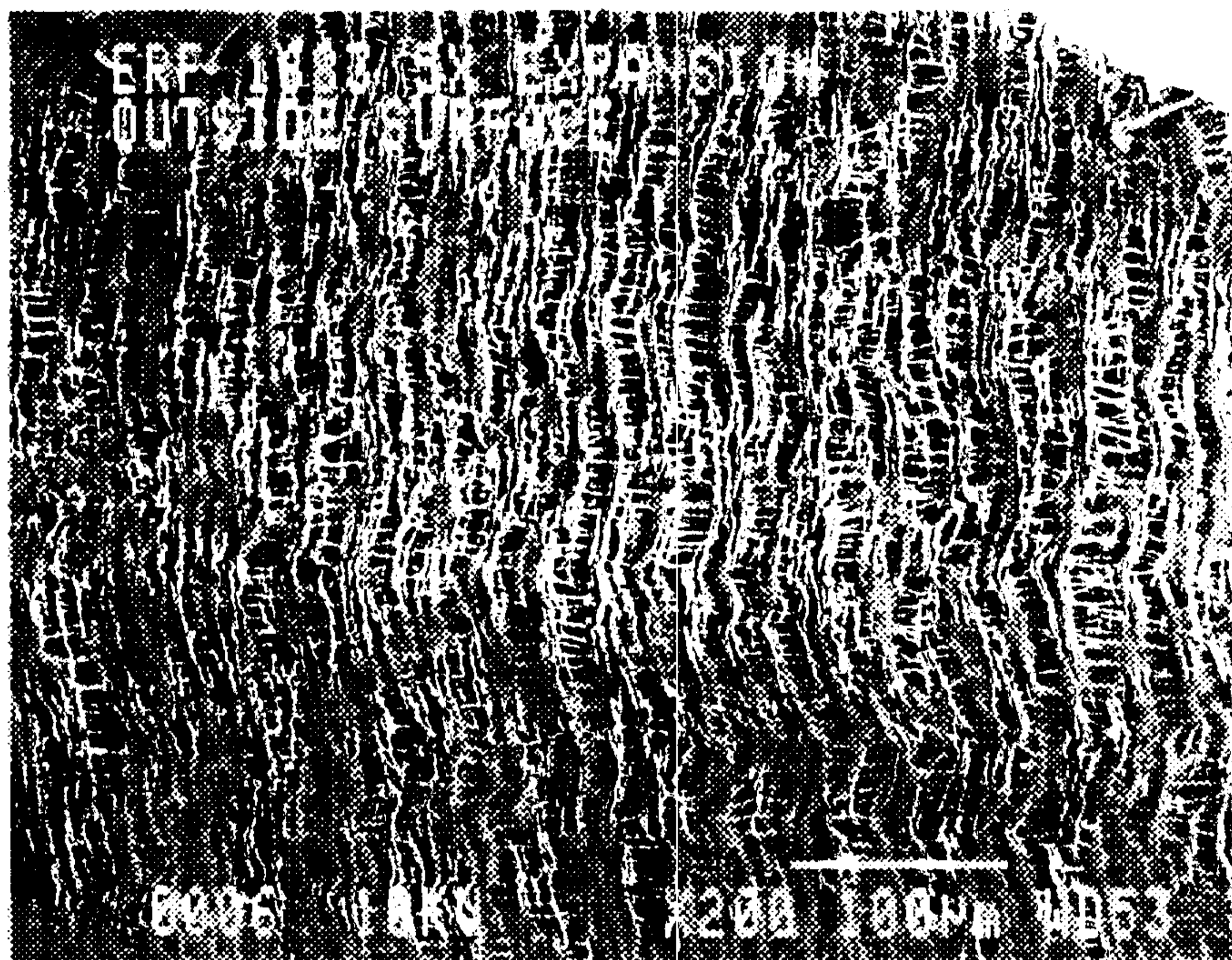

Fig. 16C

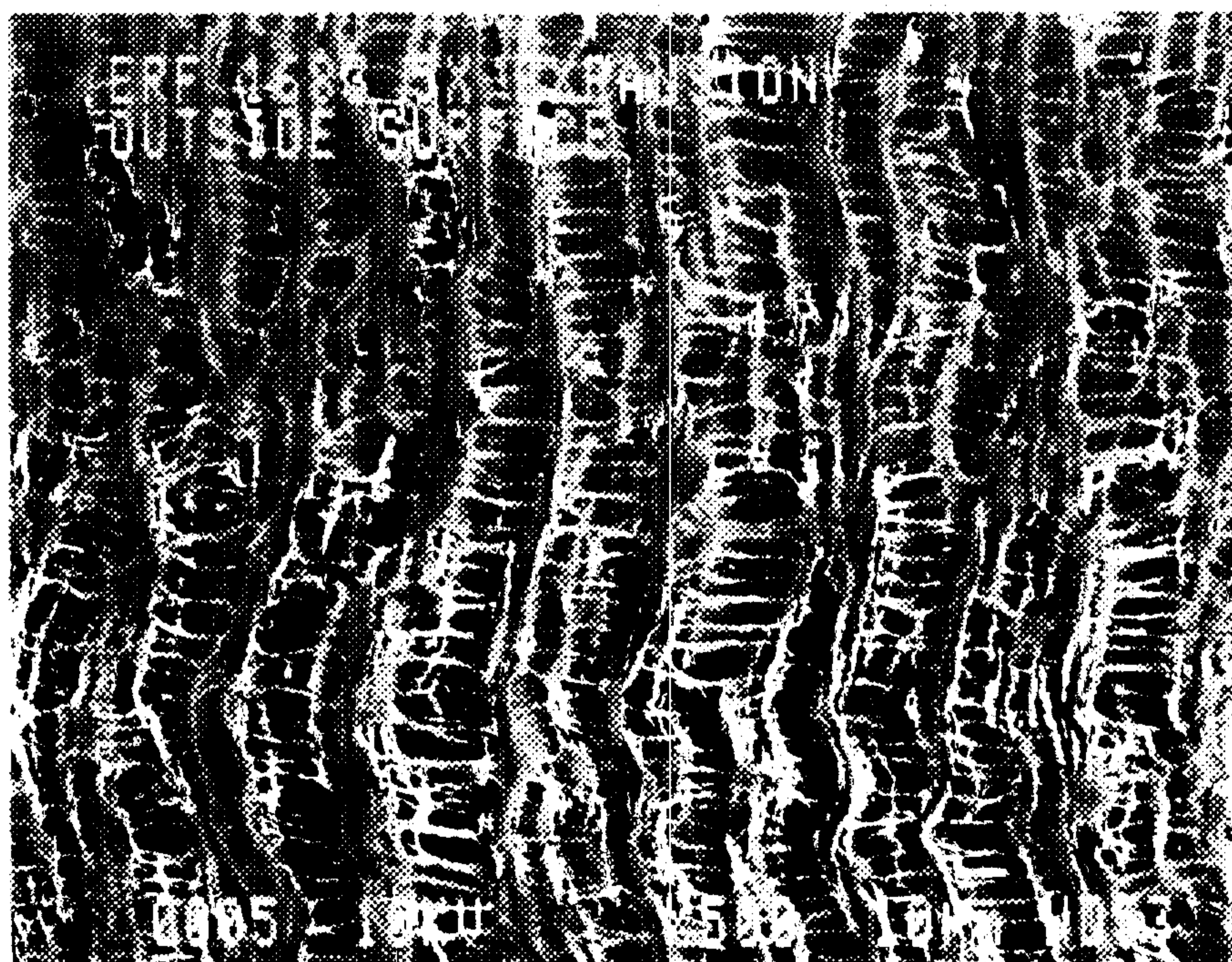

Fig. 16D

27/42

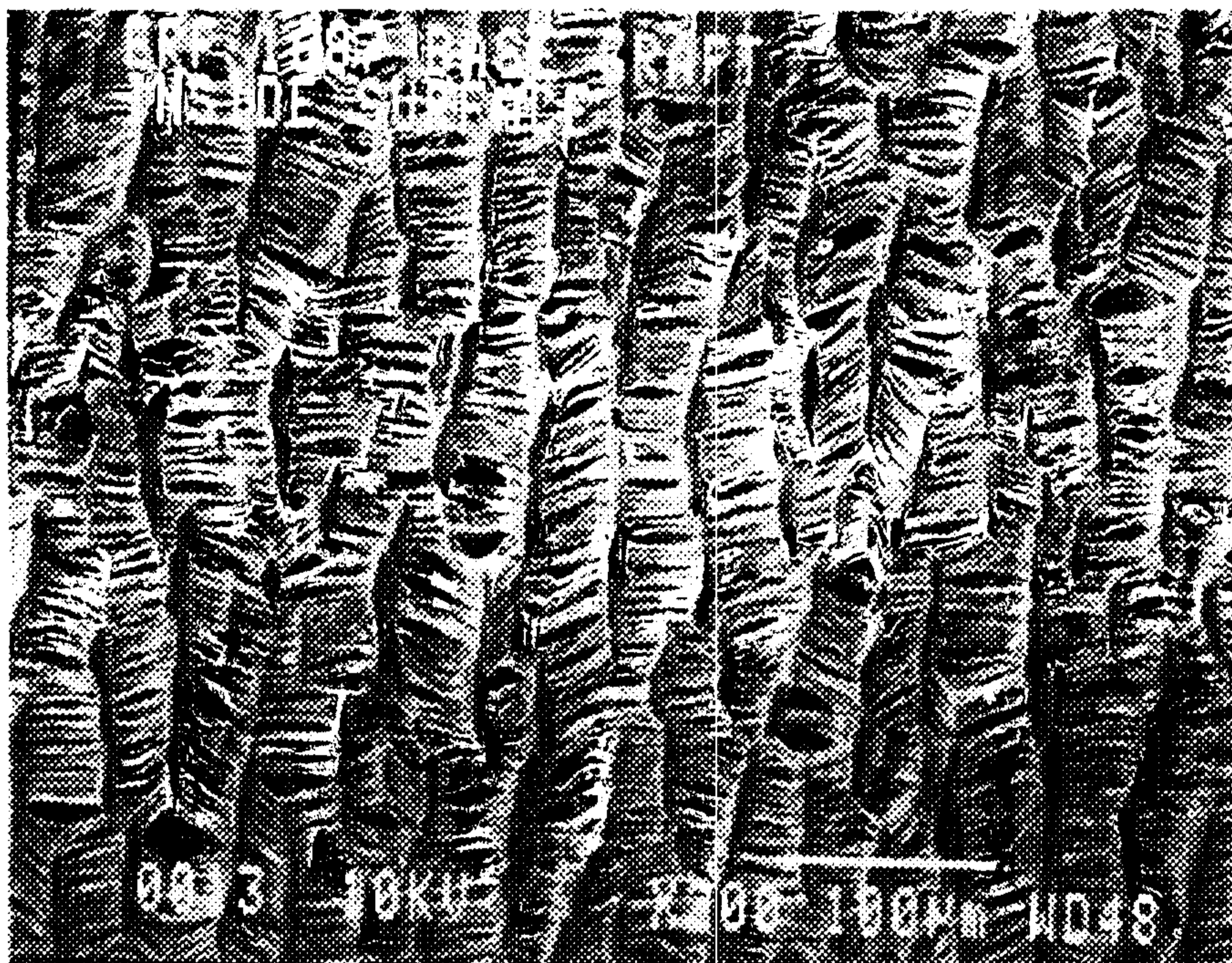

Fig. 17A

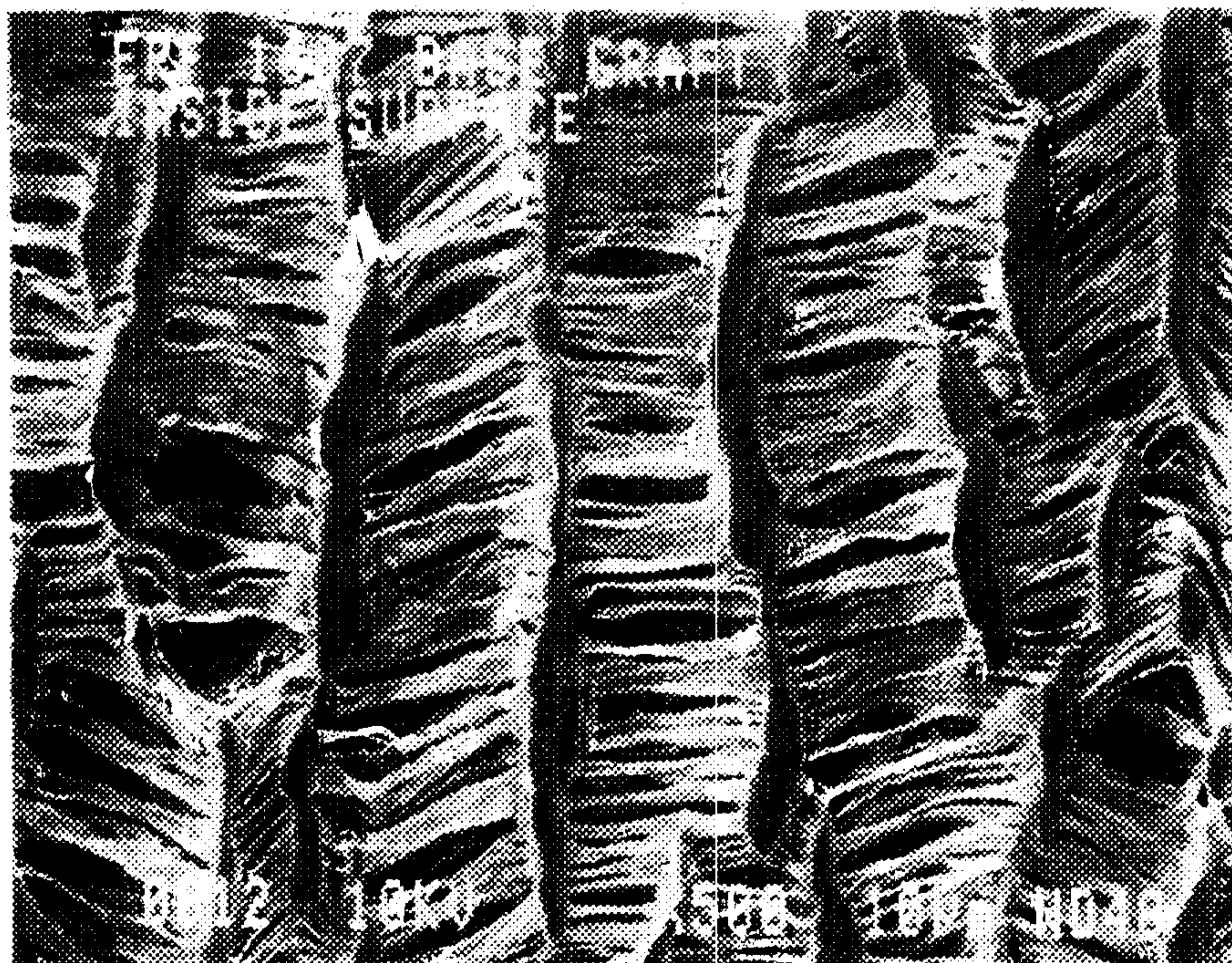

Fig. 17B

28/42

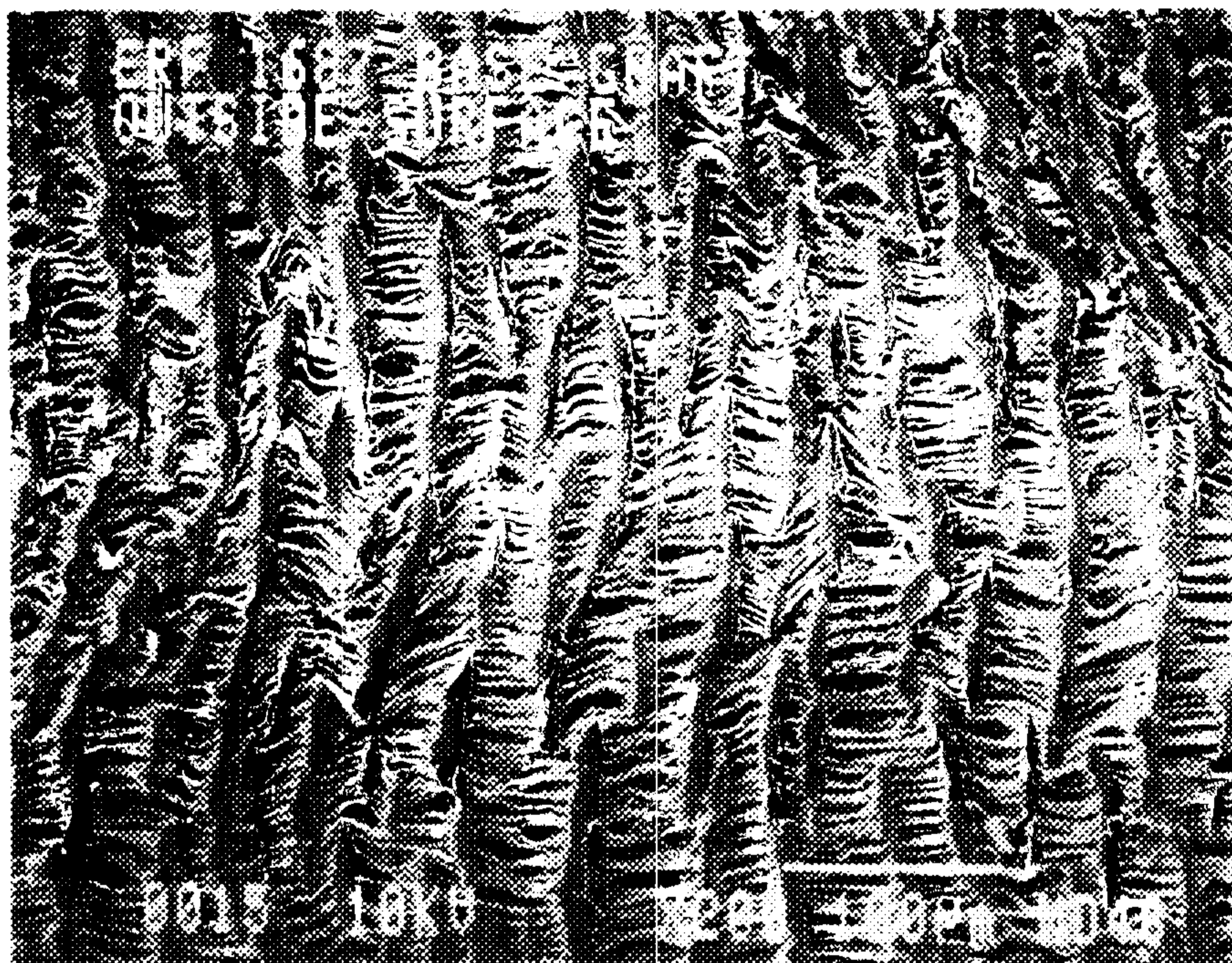

Fig. 17C

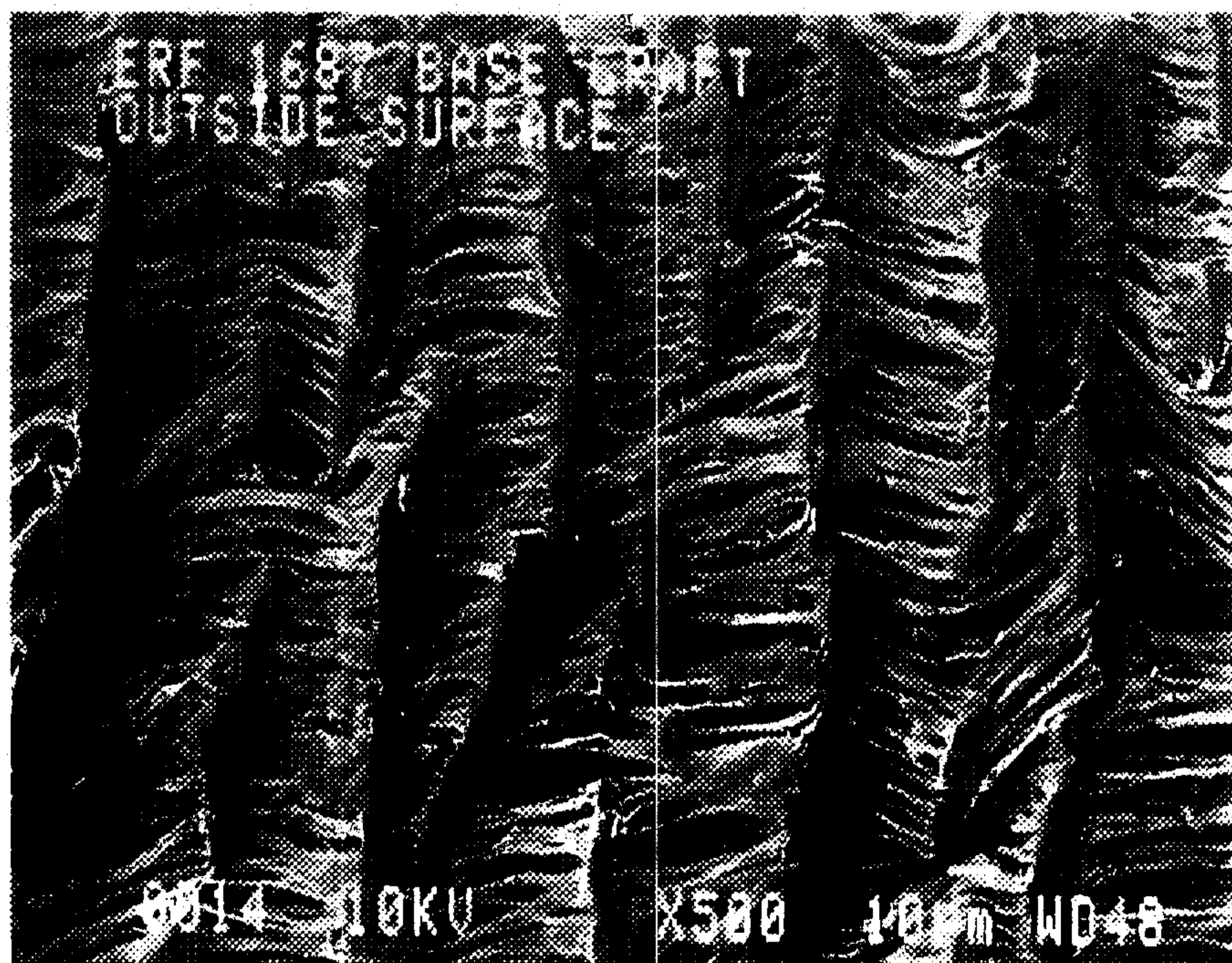

Fig. 17D

SUBSTITUTE SHEET (RULE 26)

29 / 42



Fig. 18A

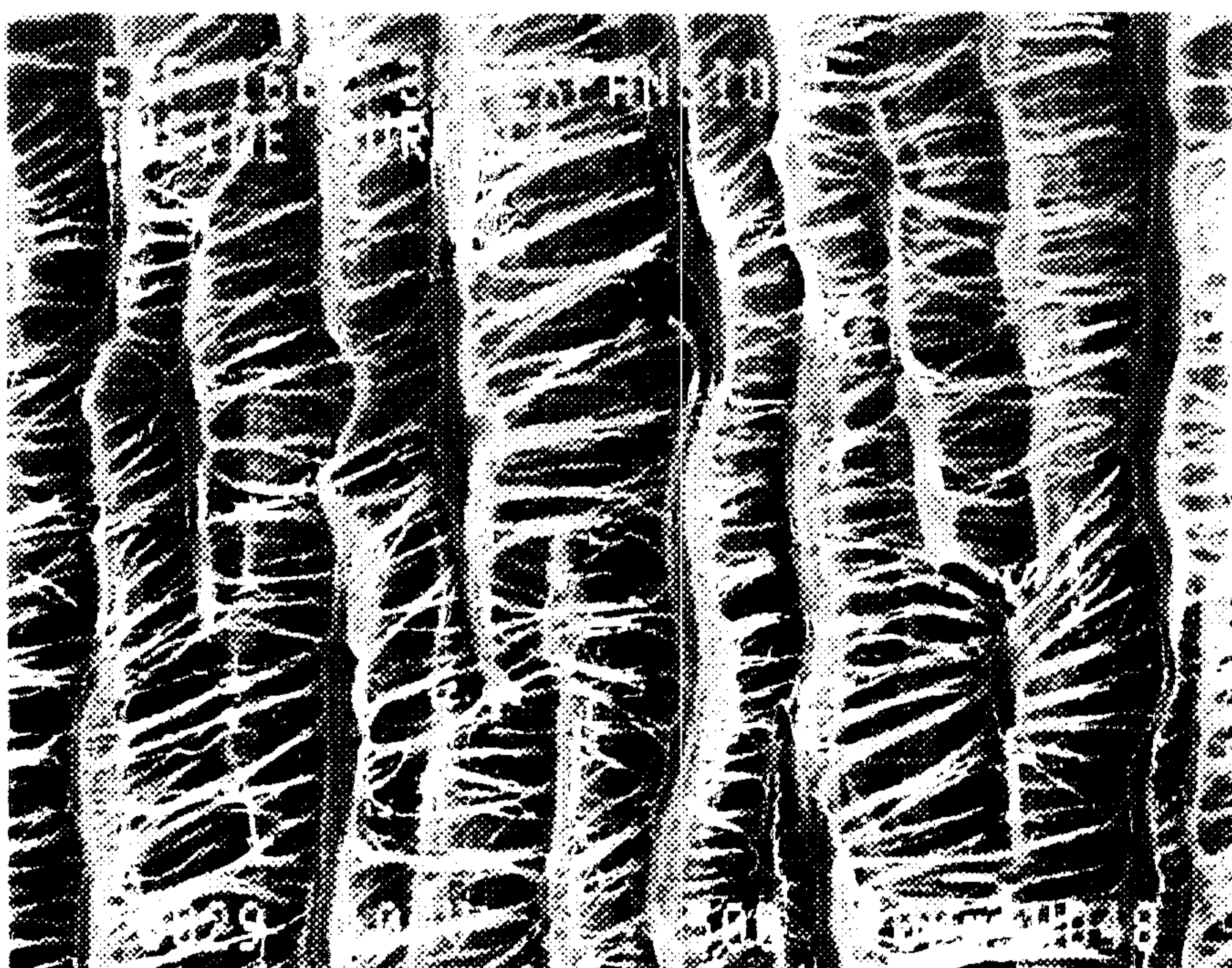

Fig. 18B

30/42

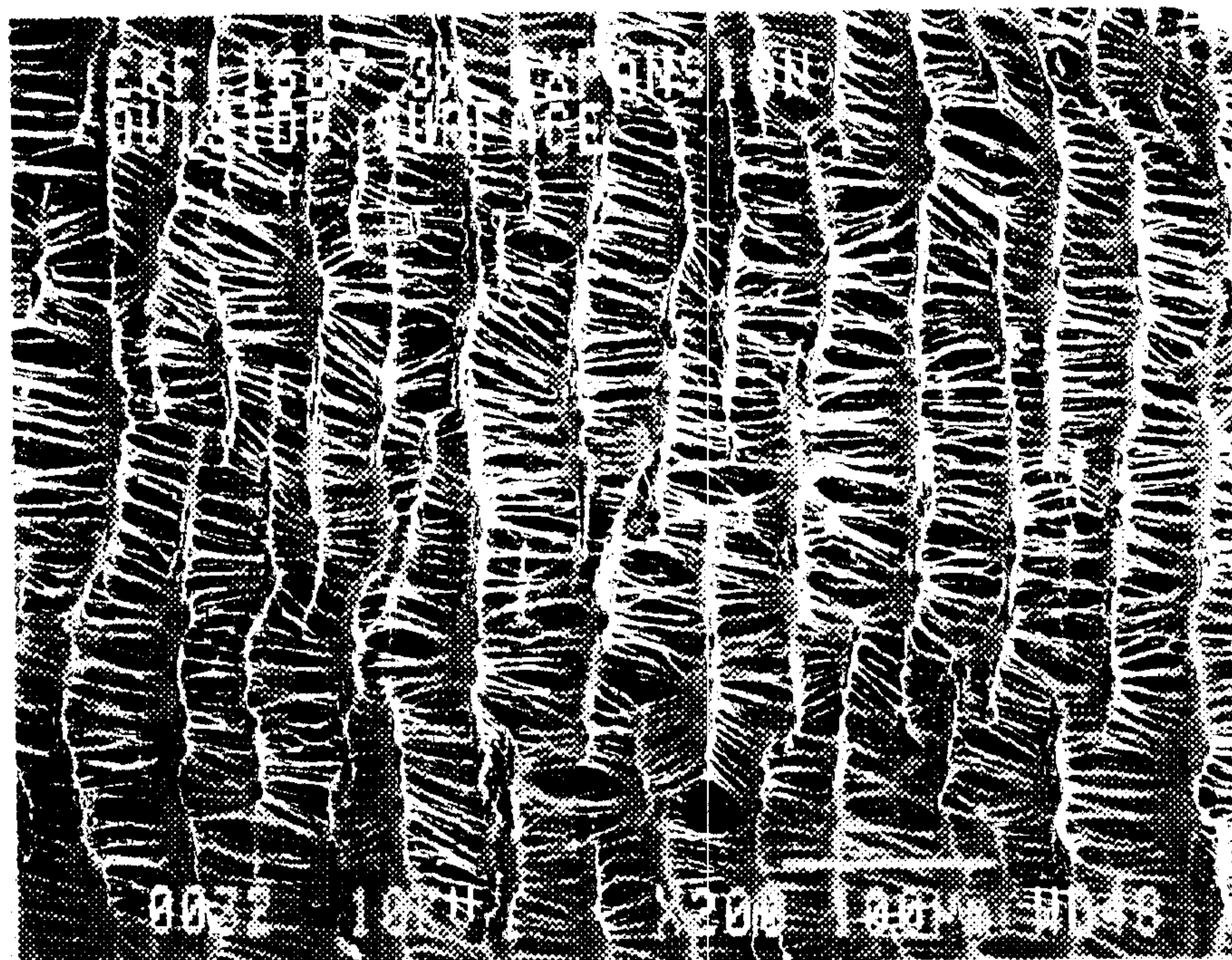

Fig. 18C

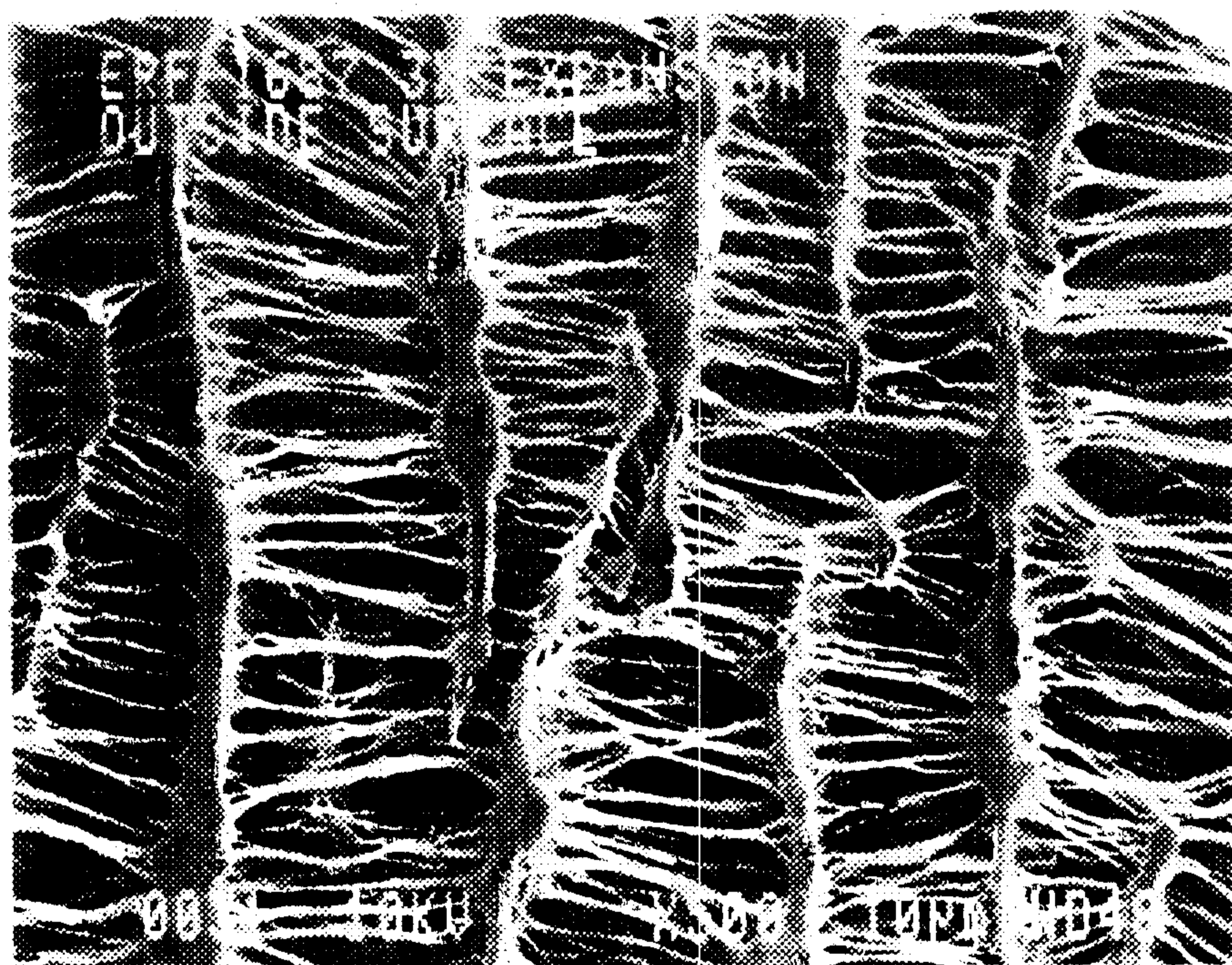

Fig. 18D

SUBSTITUTE SHEET (RULE 26)

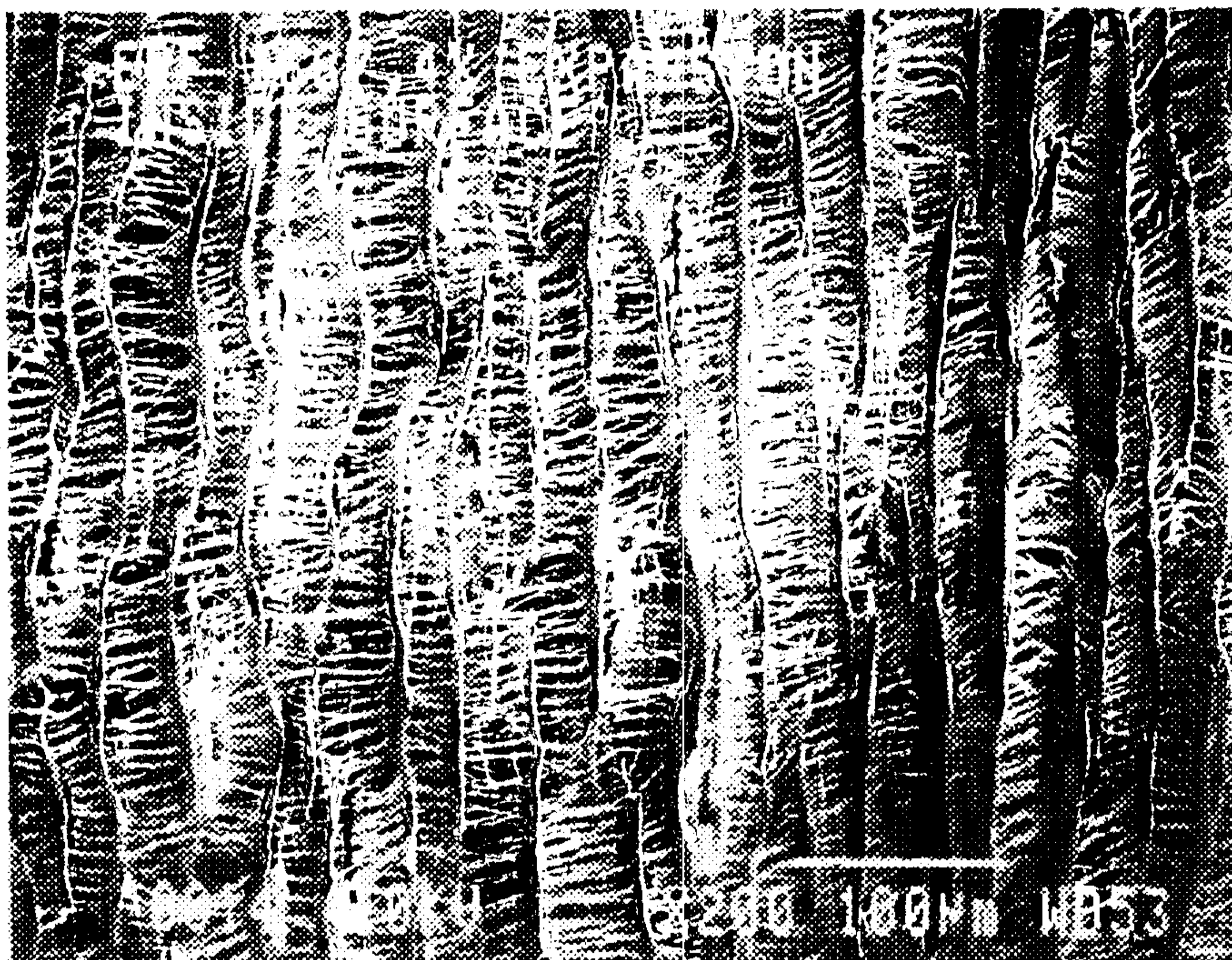

Fig. 19A

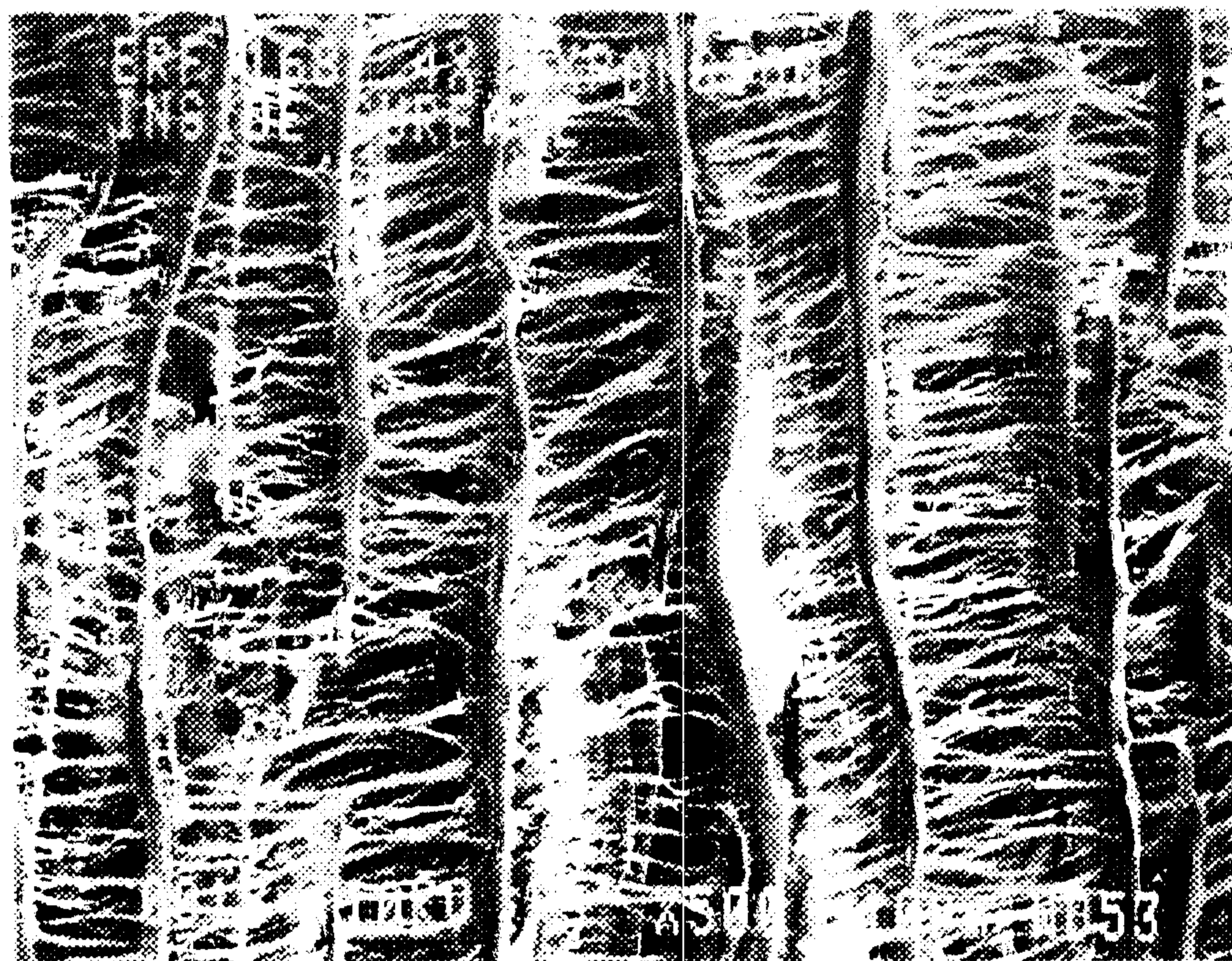

Fig. 19B

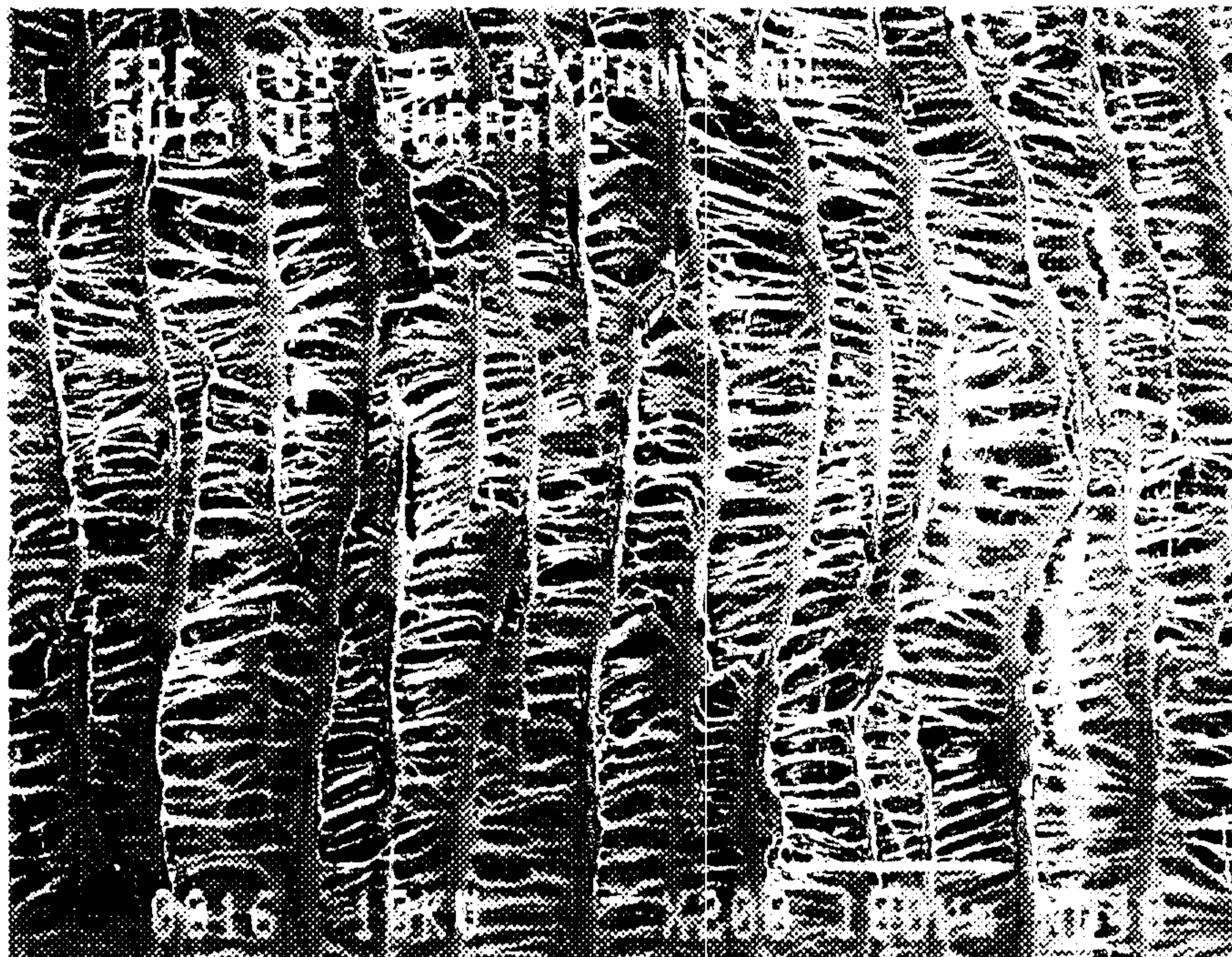

Fig. 19C

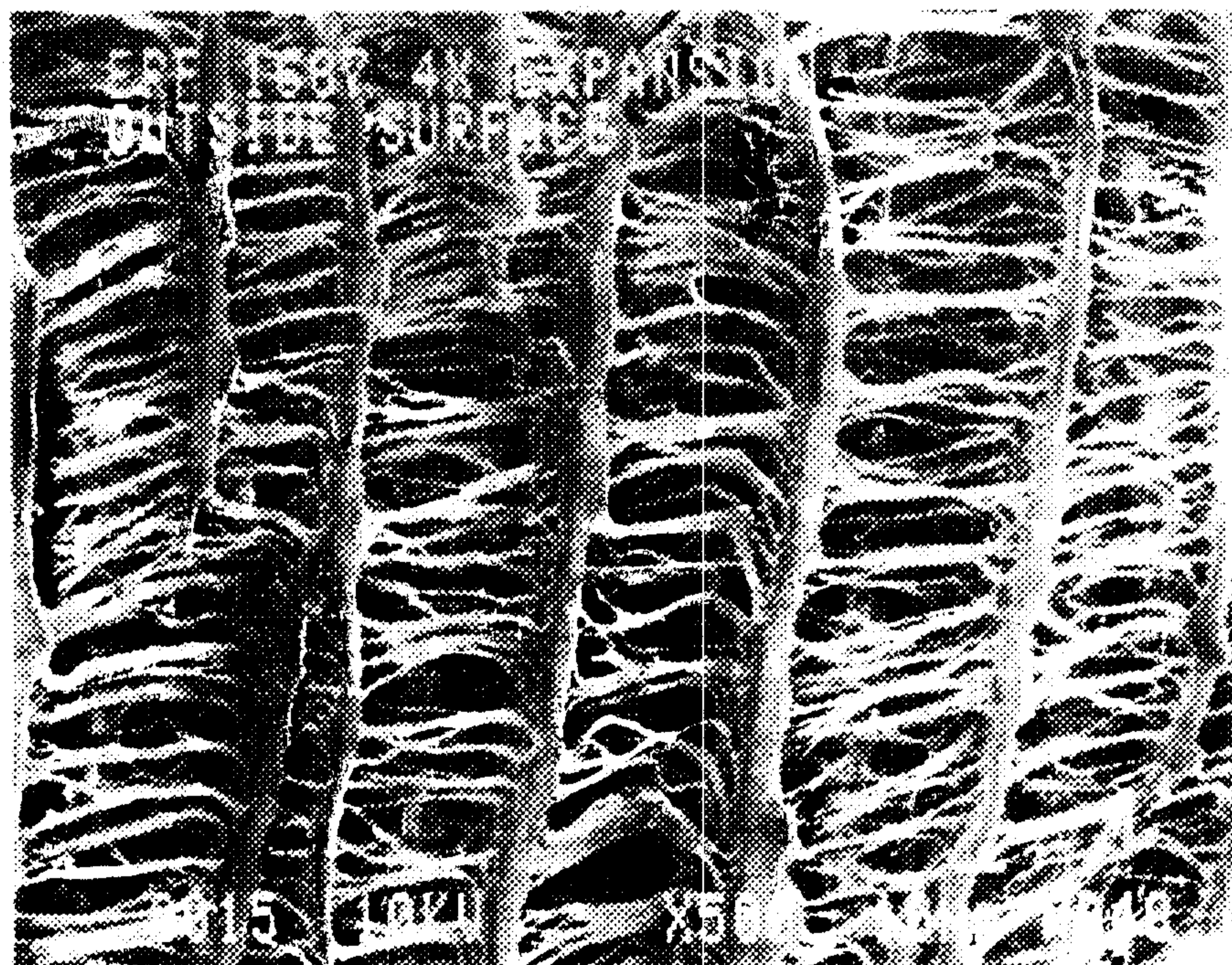

Fig. 19D

SUBSTITUTE SHEET (RULE 26)

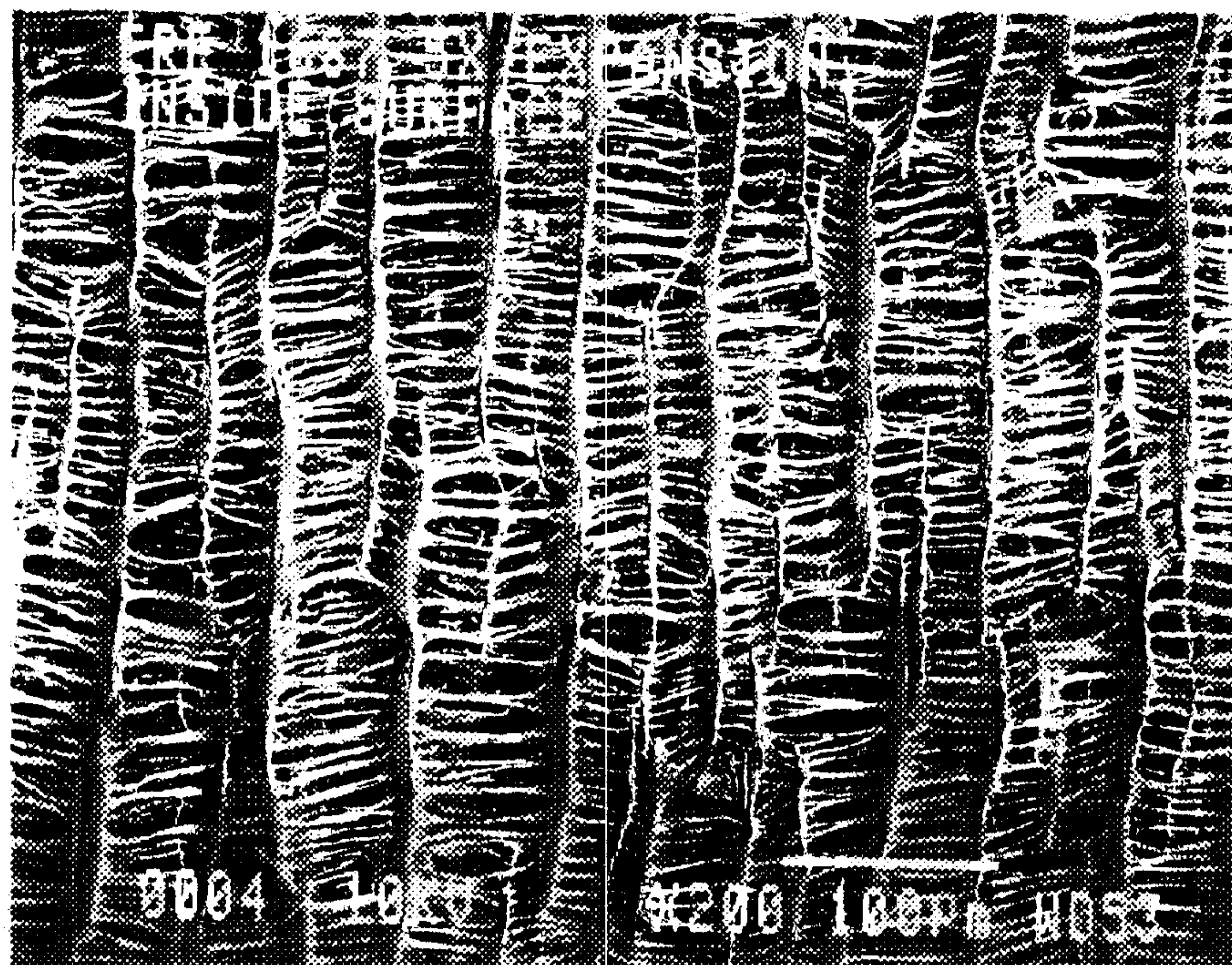

Fig. 20A

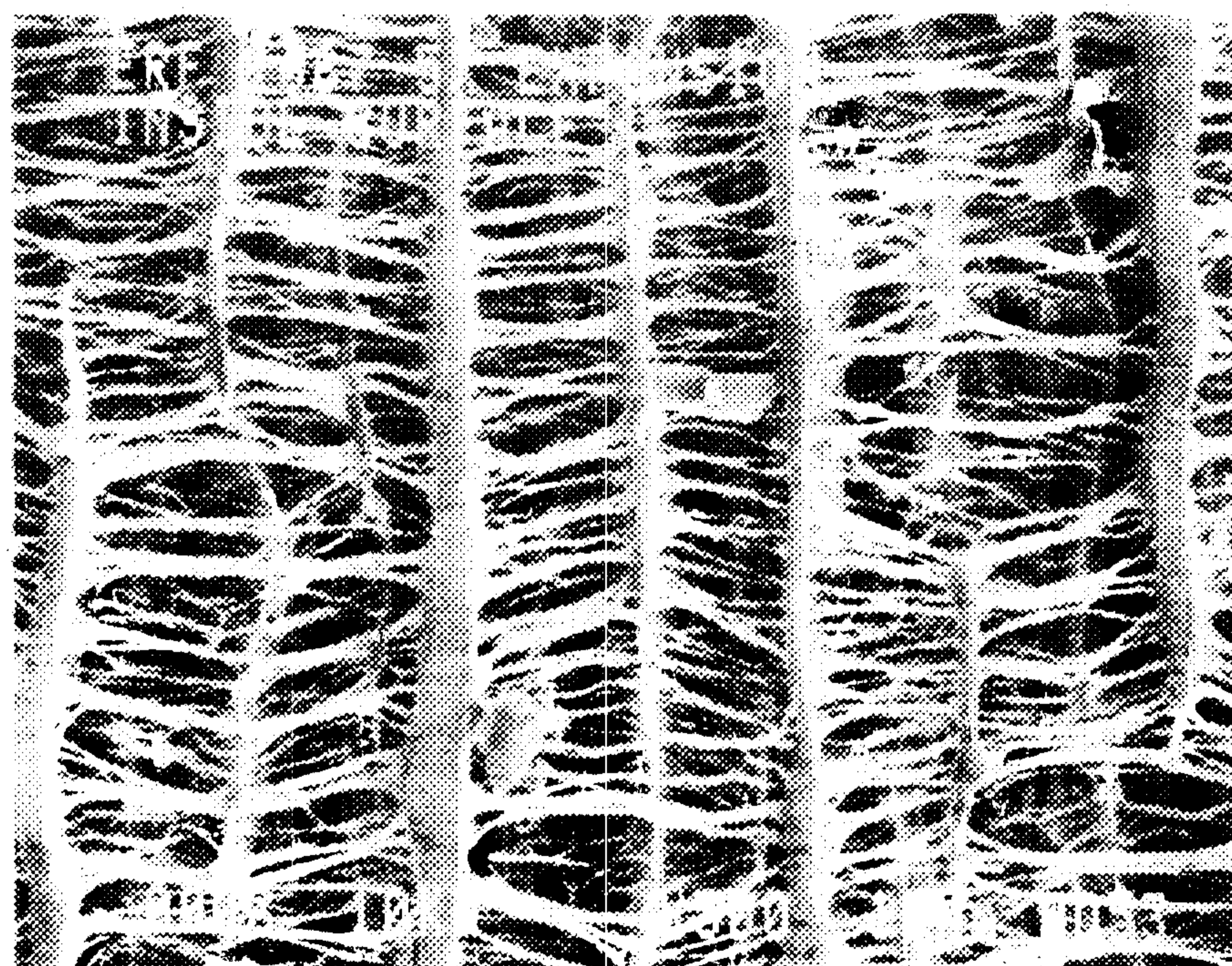

Fig. 20B

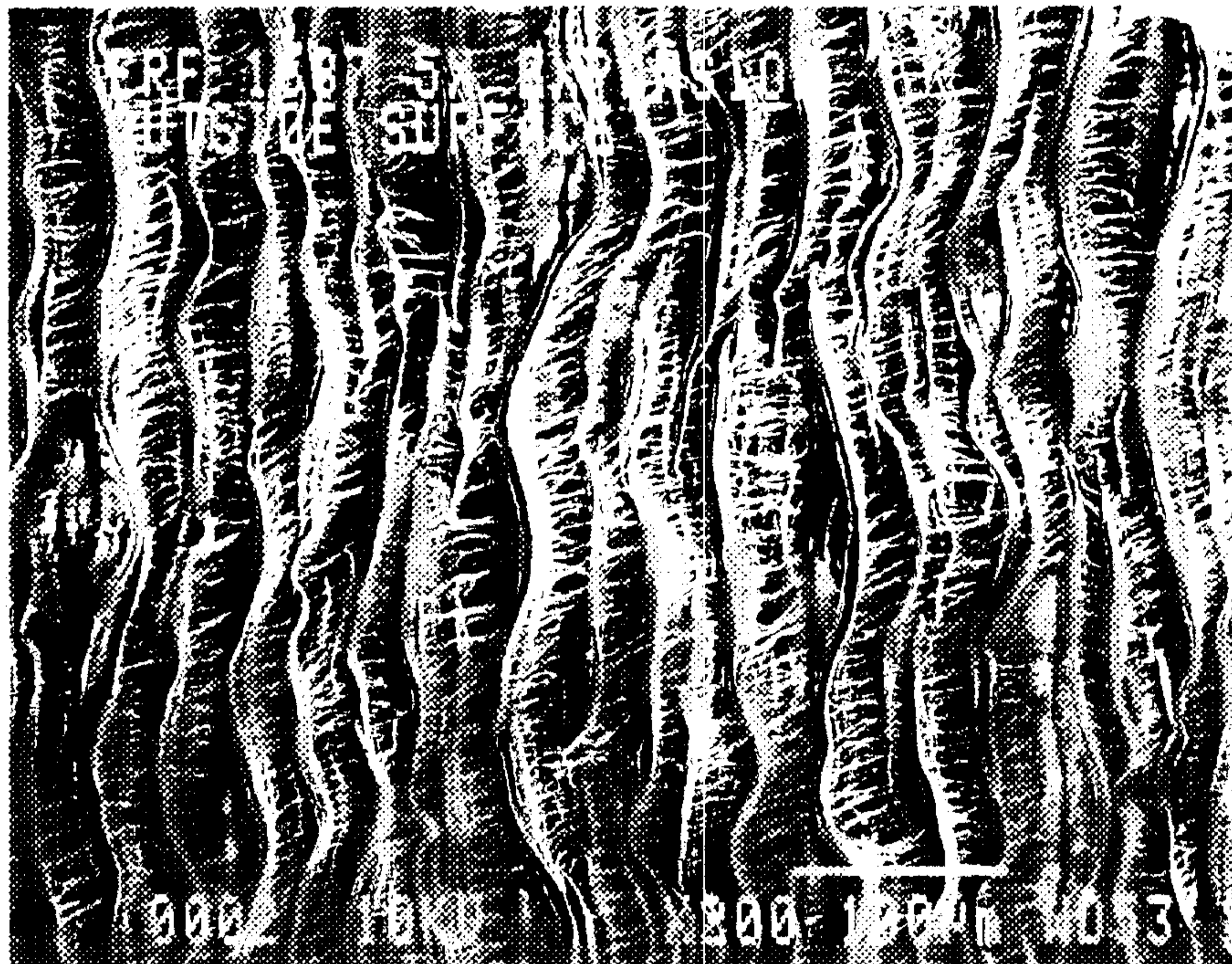

Fig. 20C



Fig. 20D

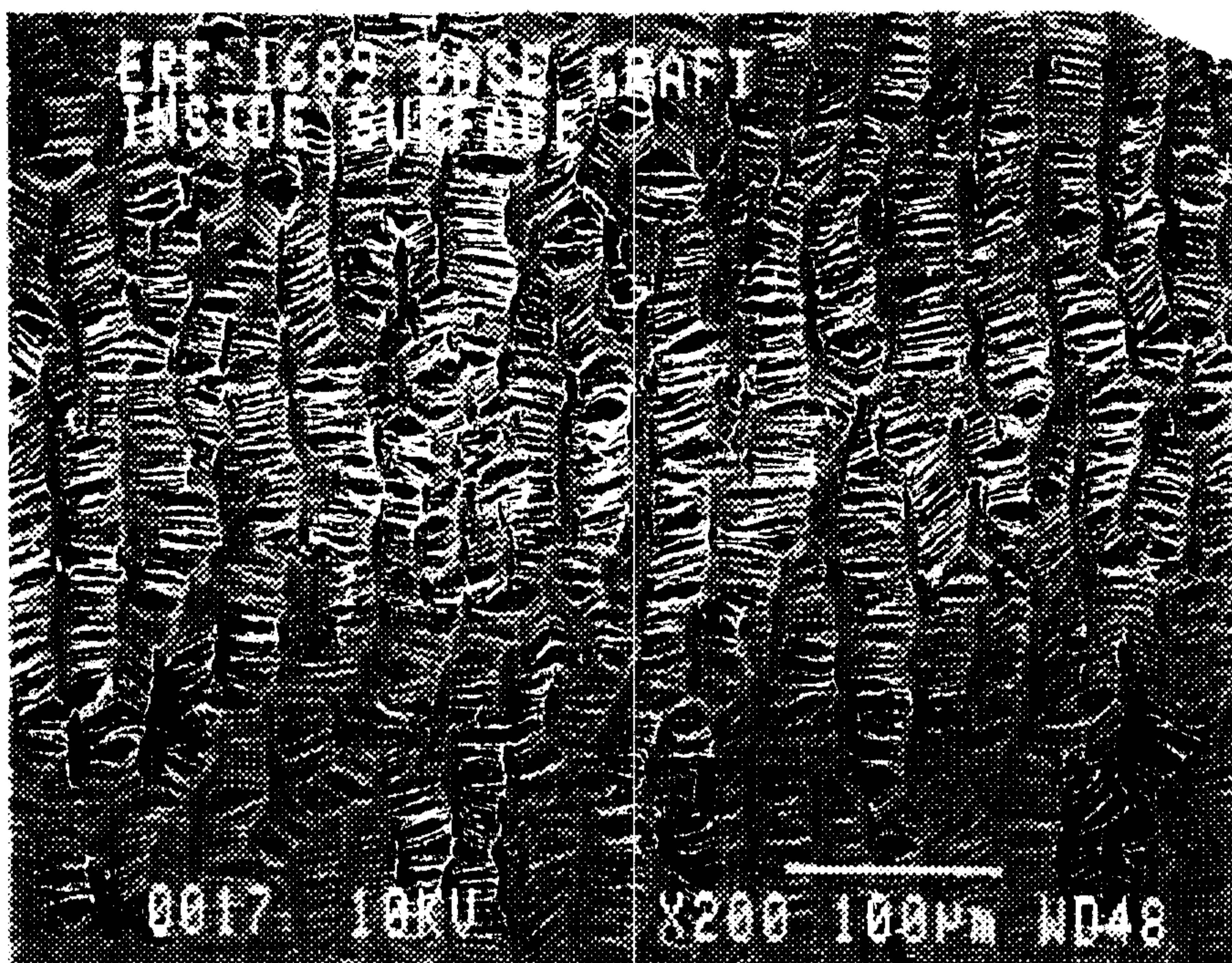

Fig. 21A

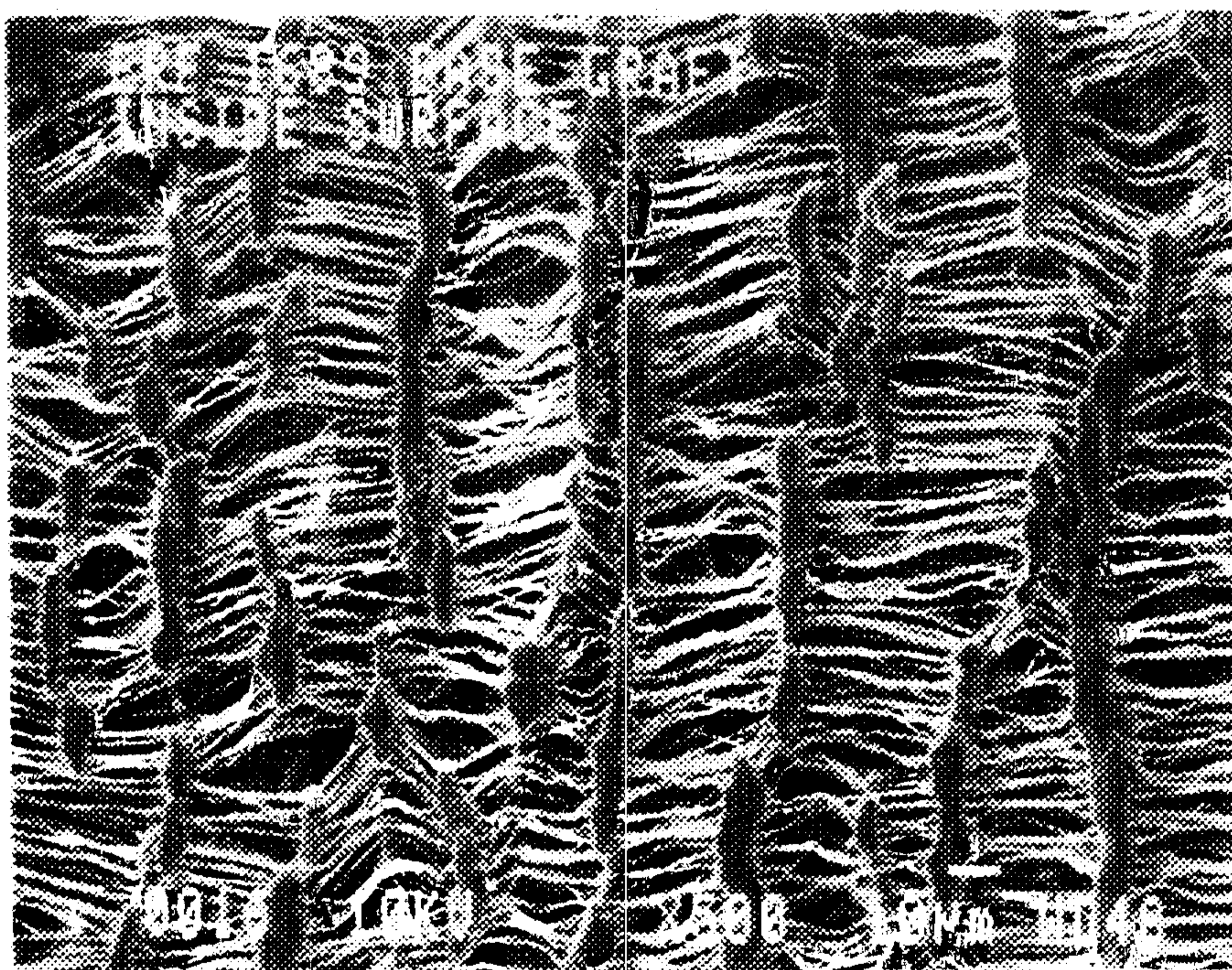

Fig. 21B

36/42

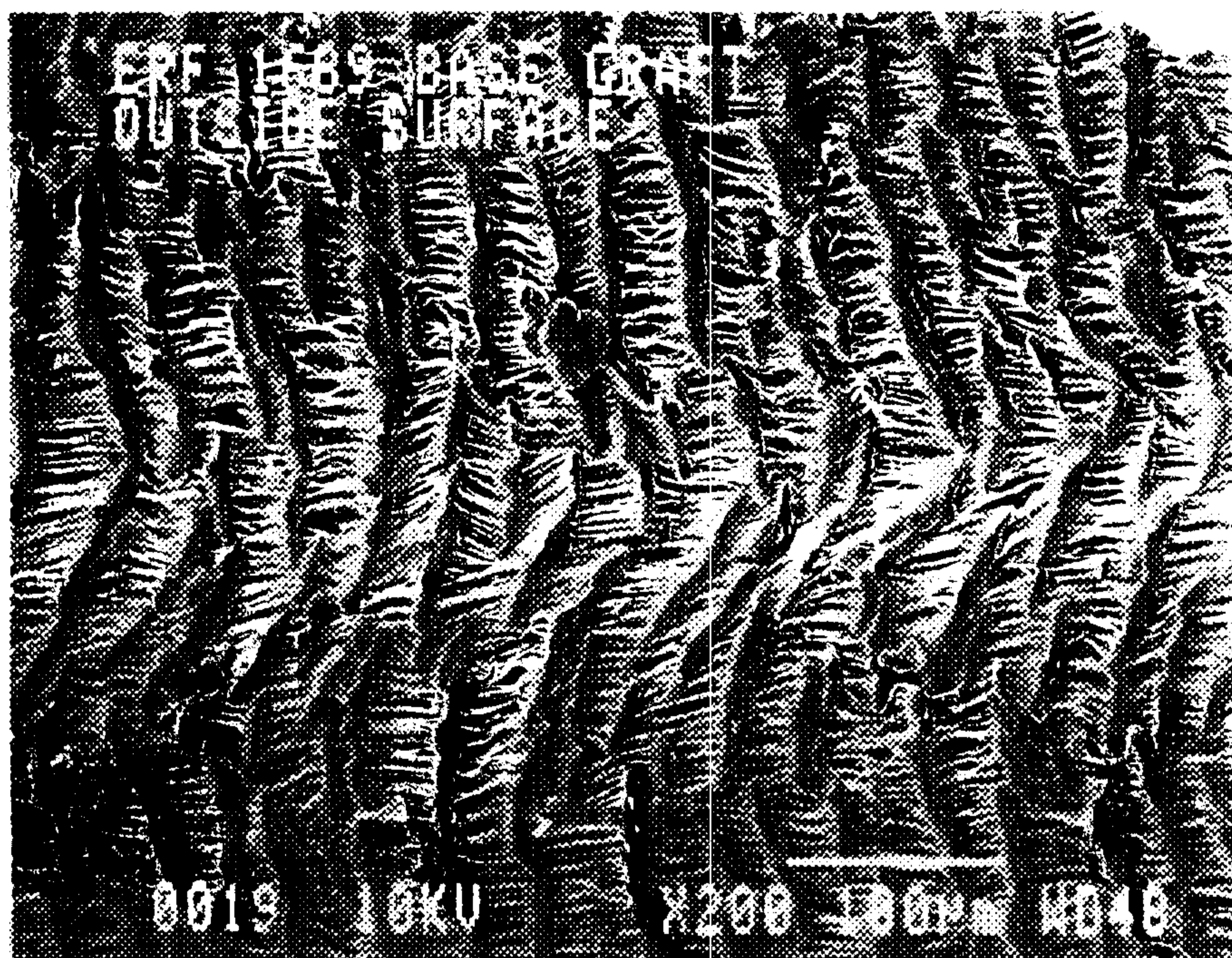

Fig. 21C



Fig. 21D

37/42

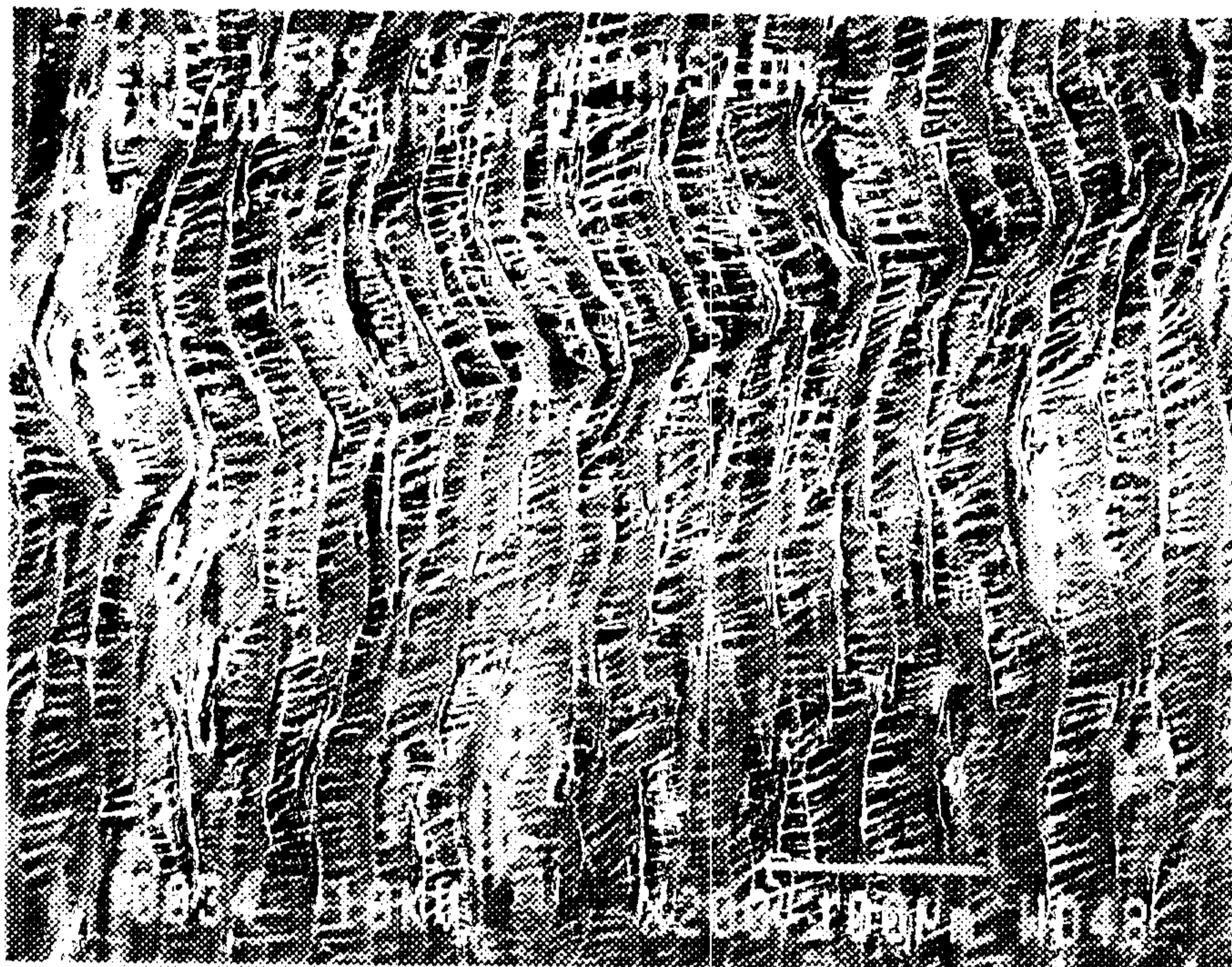

Fig. 22A

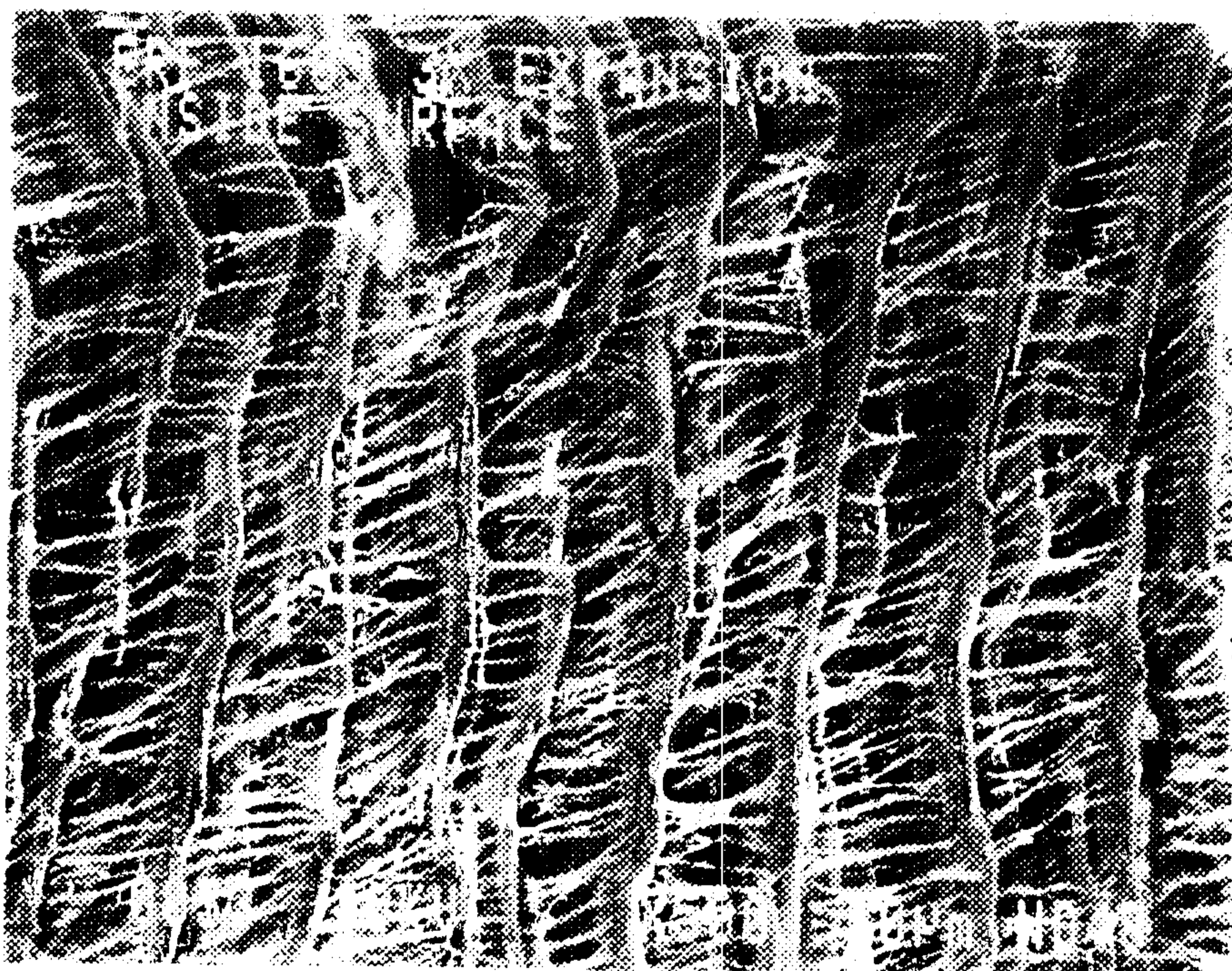

Fig. 22B

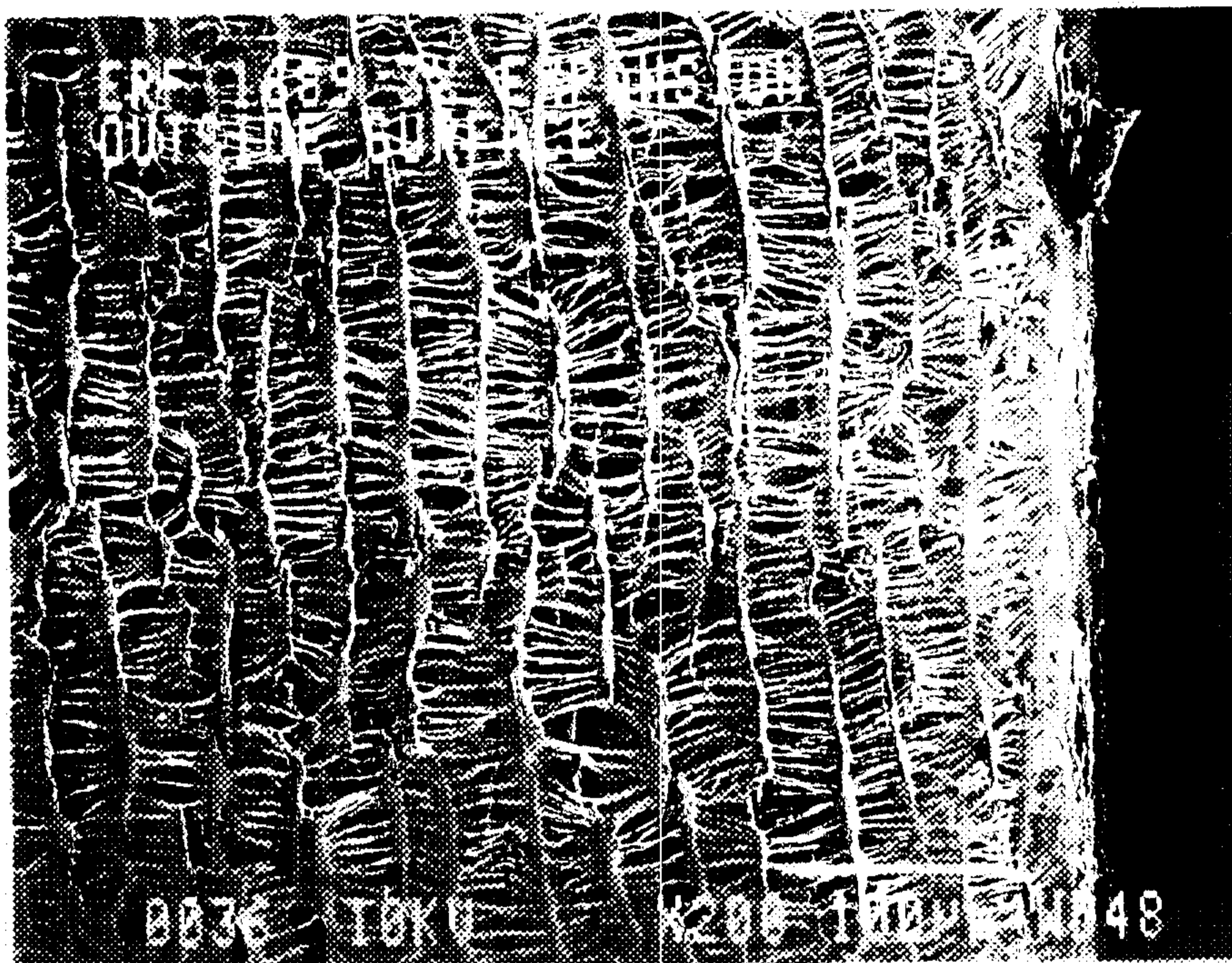

Fig. 22C

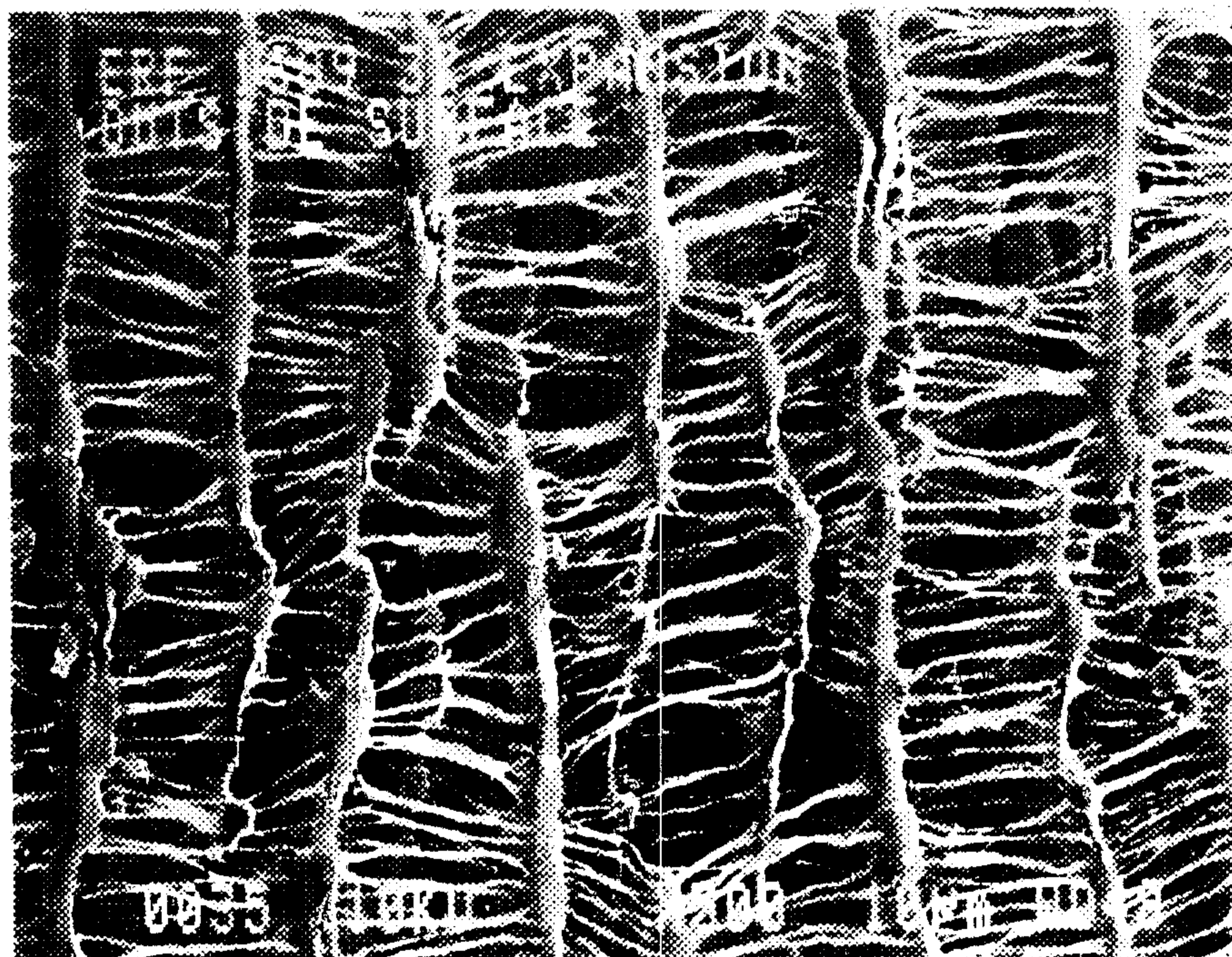

Fig. 22D

SUBSTITUTE SHEET (RULE 26)

39/42

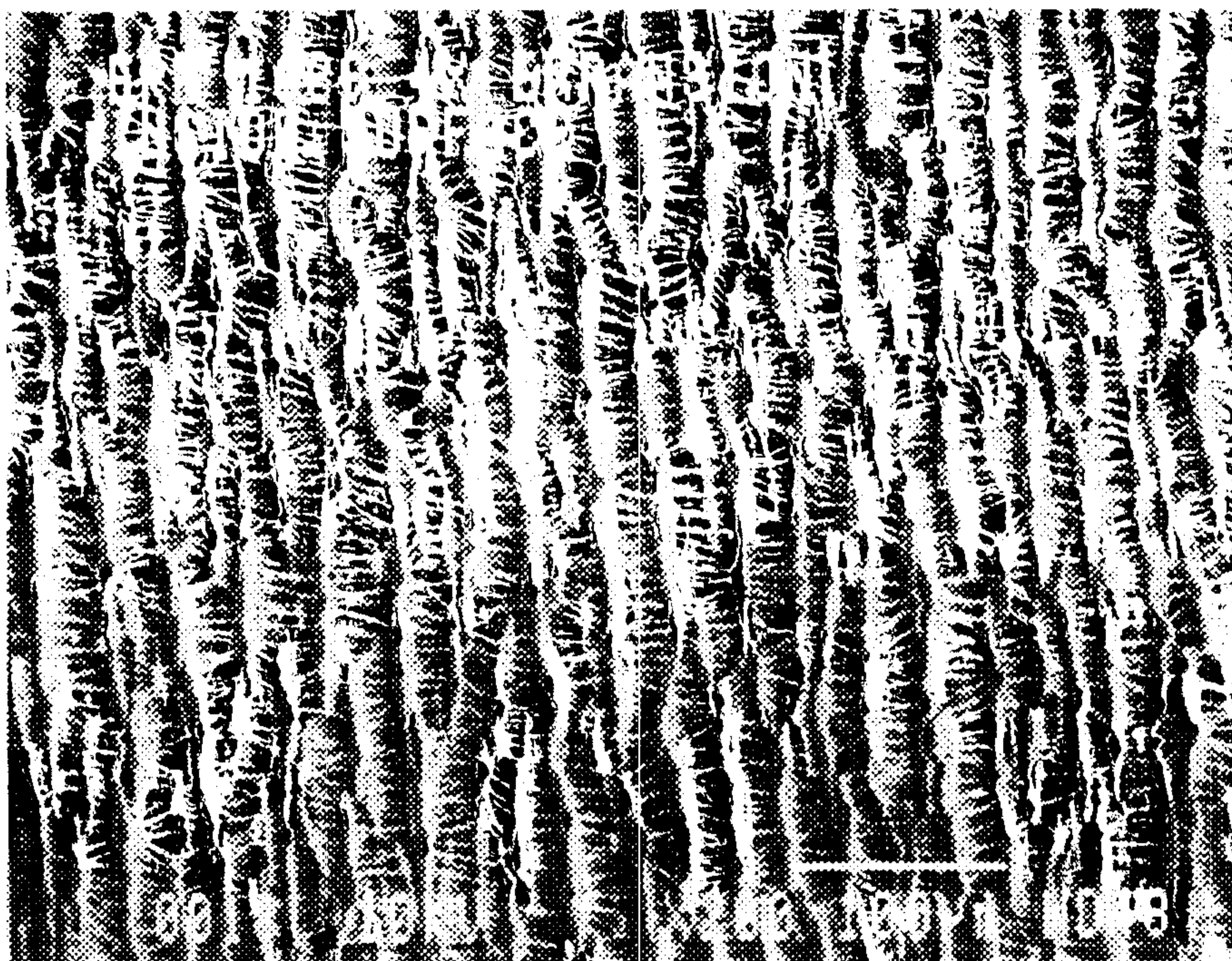

Fig. 23A

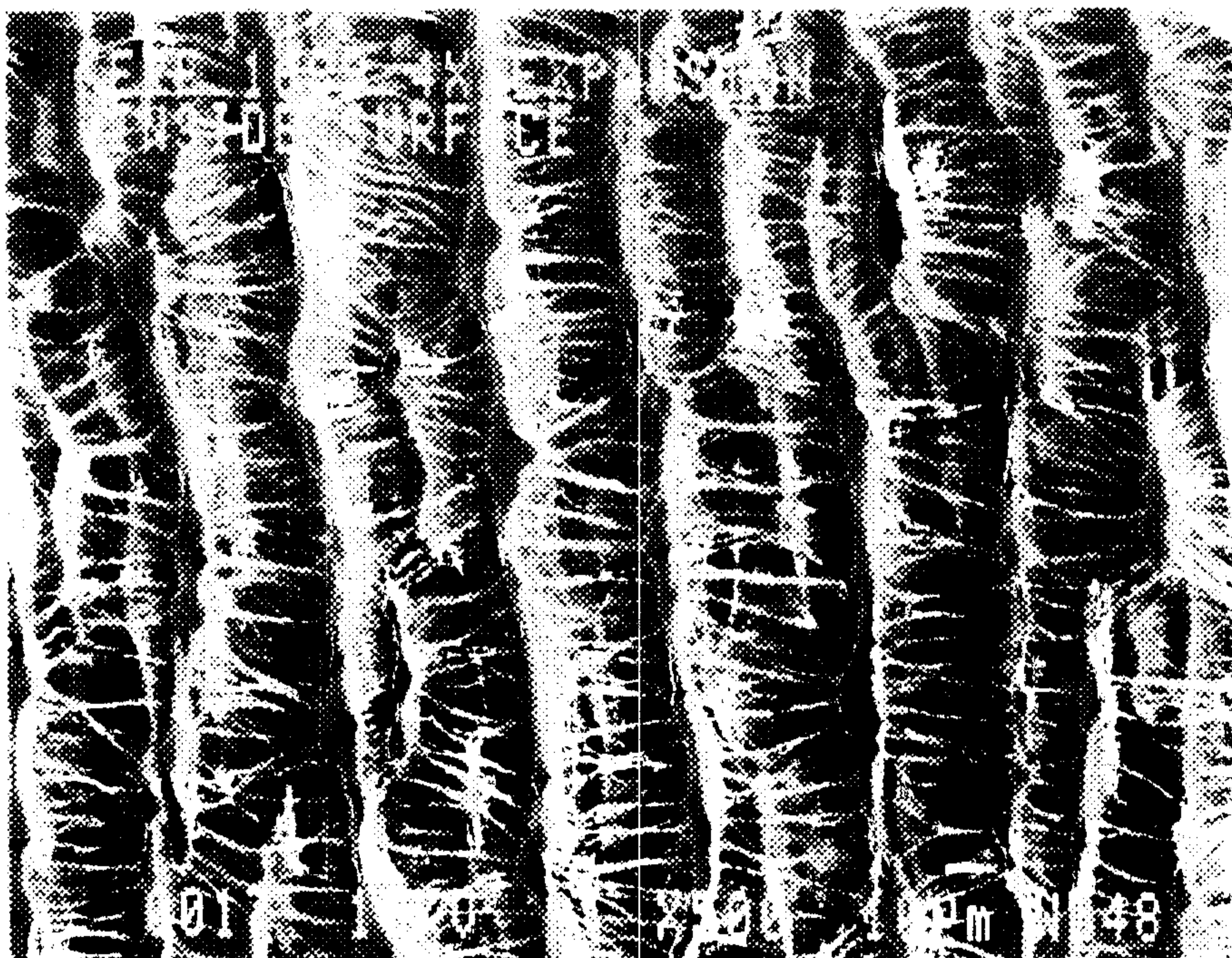

Fig. 23B

40/42

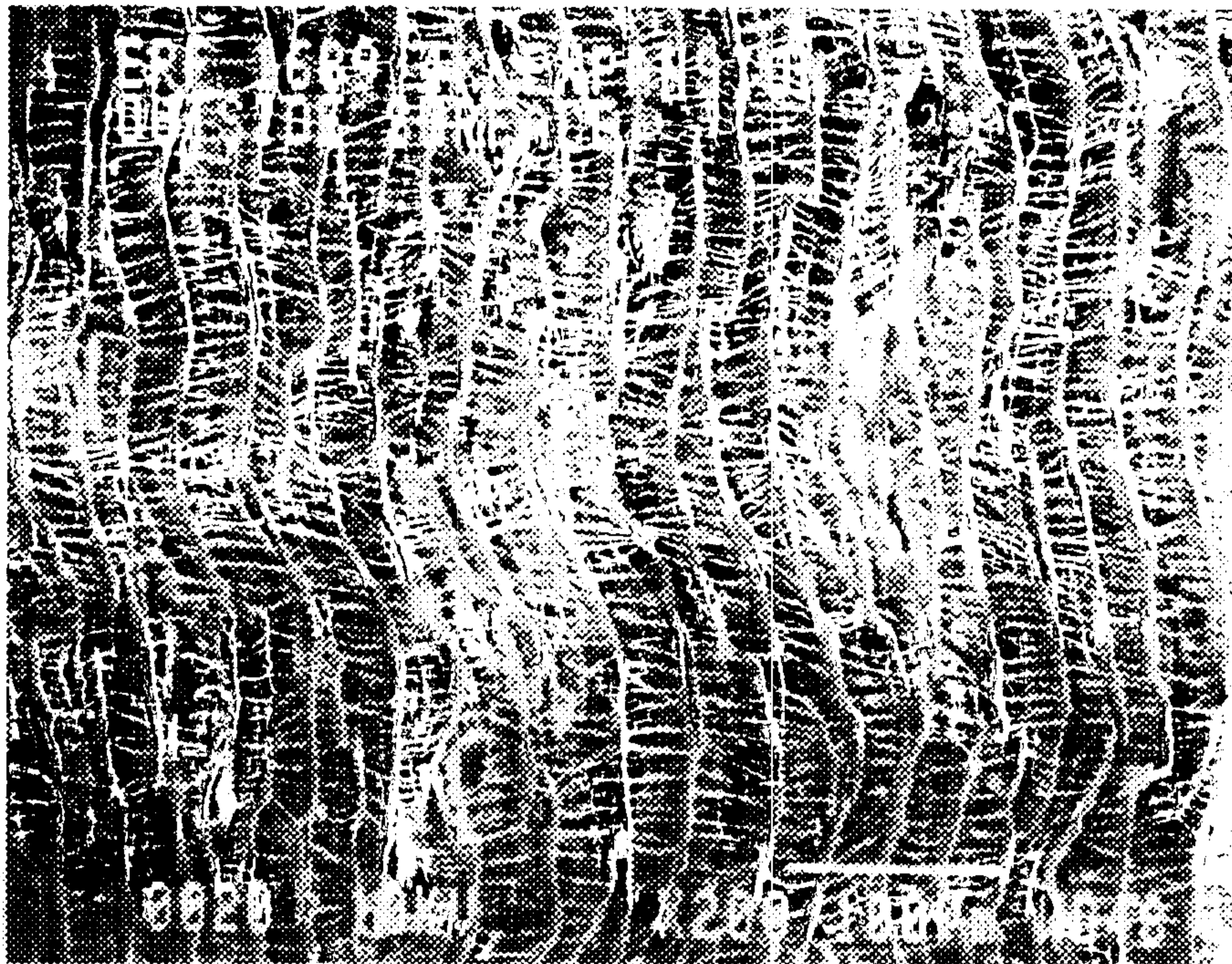

Fig. 23C

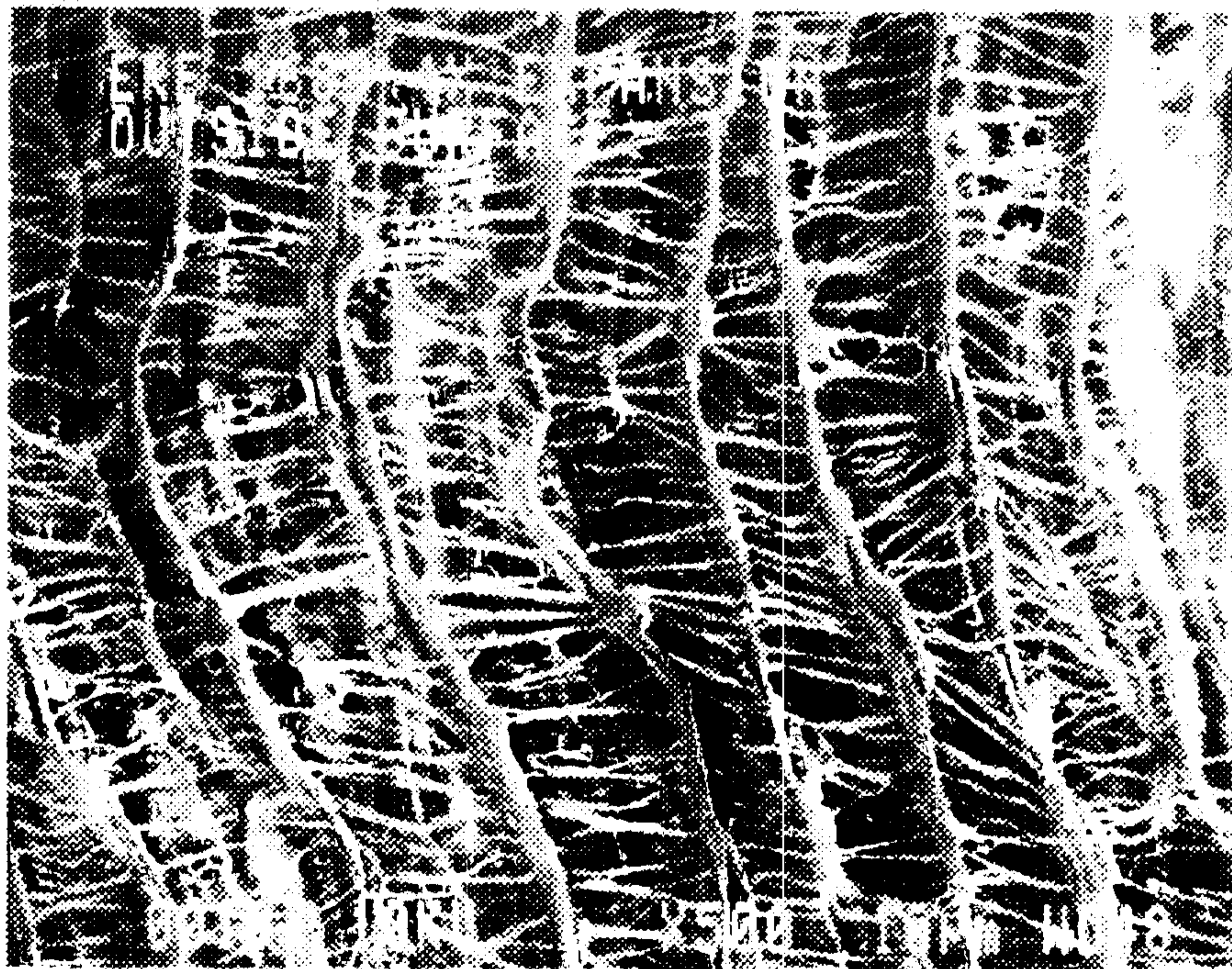

Fig. 23D

SUBSTITUTE SHEET (RULE 26)

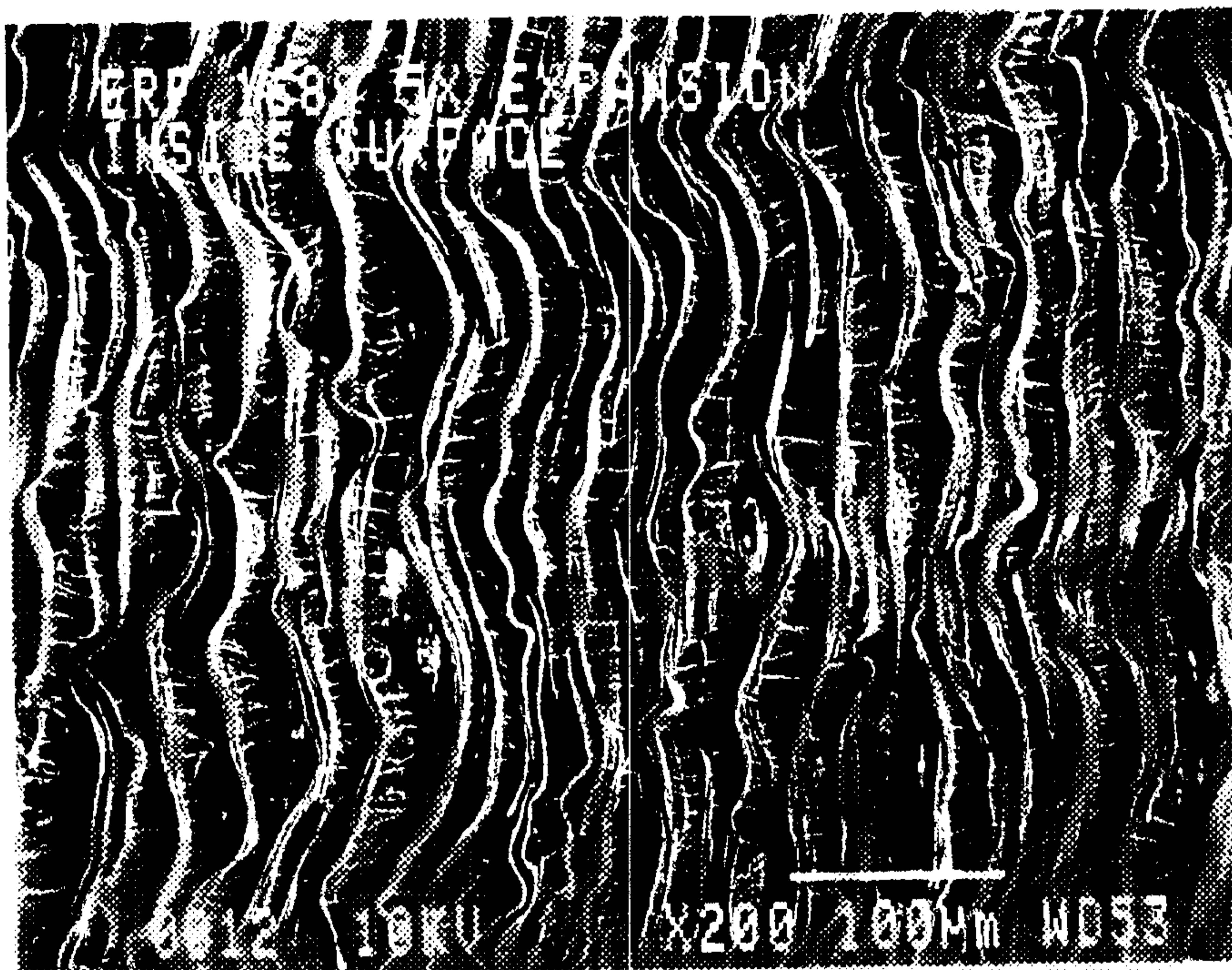

Fig. 24A



Fig. 24B

42/42



Fig. 24C

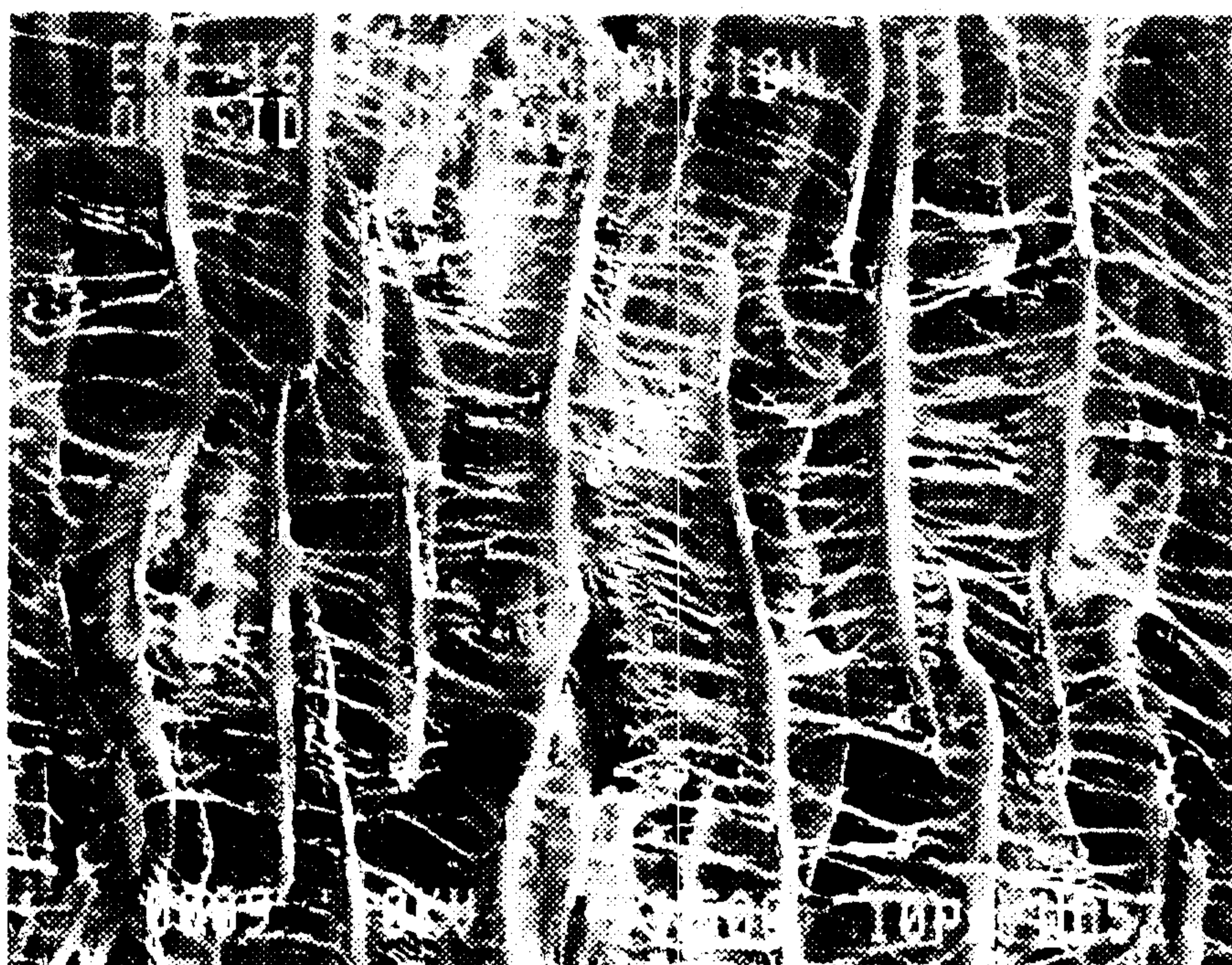

Fig. 24D

