



US00D888786S

(12) **United States Design Patent**  
**Abe et al.**

(10) **Patent No.:** **US D888,786 S**

(45) **Date of Patent:** **\*\* Jun. 30, 2020**

(54) **DRILLING TOOL**

FOREIGN PATENT DOCUMENTS

(71) Applicant: **SUMITOMO ELECTRIC**  
**HARDMETAL CORP.**, Itami-shi (JP)

JP H01-175116 U 12/1989  
JP 2002-036017 A 2/2002

(Continued)

(72) Inventors: **Machiko Abe**, Itami (JP); **Hiroyuki Shimada**, Itami (JP); **Kazuya Yano**, Itami (JP)

OTHER PUBLICATIONS

Office Action dated Sep. 13, 2018 in Design U.S. Appl. No. 29/550,577 [Related Application].

(Continued)

(73) Assignee: **Sumitomo Electric Hardmetal Corp.**, Itami-shi (JP)

(\*\*) Term: **15 Years**

*Primary Examiner* — Patricia A Palasik

(74) *Attorney, Agent, or Firm* — Baker Botts L.L.P.; Michael A. Sartori

(21) Appl. No.: **29/648,968**

(57) **CLAIM**

(22) Filed: **May 25, 2018**

The ornamental design for a drilling tool, as shown and described.

**Related U.S. Application Data**

**DESCRIPTION**

(62) Division of application No. 29/550,577, filed on Jan. 5, 2016.

FIG. 1 is a front view of a drilling tool of an embodiment showing our new design,

(30) **Foreign Application Priority Data**

FIG. 2 is a rear view thereof;

Jul. 6, 2015 (JP) ..... 2015-015001

FIG. 3 is a top view thereof;

Jul. 6, 2015 (JP) ..... 2015-015002

FIG. 4 is a bottom view thereof;

(Continued)

FIG. 5 is a right side view thereof;

(51) **LOC (12) Cl.** ..... **15-09**

FIG. 6 is a left side view thereof;

(52) **U.S. Cl.**

FIG. 7 is a perspective view thereof;

USPC ..... **D15/139**

FIG. 8 is an enlarged front view of the 8-12 through 8-12 portion of FIG. 1,

(58) **Field of Classification Search**

FIG. 9 is an enlarged top view of the 8-12 through 8-12 portion of FIG. 1,

USPC ..... D8/86; D15/131, 132, 138, 139, 140

FIG. 10 is an enlarged right side view of the 8-12 through 8-12 portion of FIG. 1,

(Continued)

FIG. 11 is an enlarged first perspective view of the 8-12 through 8-12 portion of FIG. 1; and,

(56) **References Cited**

FIG. 12 is an enlarged second perspective view of the 8-12 through 8-12 portion of FIG. 1.

U.S. PATENT DOCUMENTS

4,821,819 A 4/1989 Whysong  
5,161,859 A 11/1992 Larsson et al.

The broken lines shown in the drawings represent portions of the drilling tool that form no part of the claimed design.

(Continued)

**1 Claim, 9 Drawing Sheets**

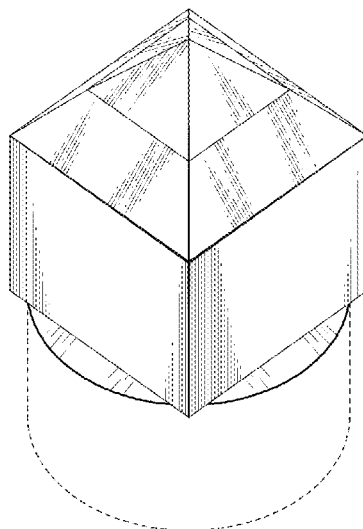

**(30) Foreign Application Priority Data**

Jul. 6, 2015 (JP) ..... 2015-015004  
 Jul. 6, 2015 (JP) ..... 2015-015005

9,316,058 B2 4/2016 Bilen et al.  
 9,610,555 B2 4/2017 Mukhopadhyay et al.  
 9,683,410 B2 6/2017 Zhang et al.  
 9,739,097 B2 8/2017 Zhang et al.

**(58) Field of Classification Search**

CPC ... B23K 31/025; B23K 35/0222; E21B 10/56;  
 E21C 35/183; E21C 2035/1806  
 See application file for complete search history.

**FOREIGN PATENT DOCUMENTS**

JP 2005-022102 A 1/2005  
 JP 2012-011475 A 1/2012  
 JP D1522840 4/2015  
 TW D156297 10/2013

**(56) References Cited**

**U.S. PATENT DOCUMENTS**

5,172,779 A 12/1992 Siracki et al.  
 5,417,475 A 5/1995 Graham et al.  
 D371,374 S 7/1996 Fischer et al.  
 5,634,821 A \* 6/1997 Crane, Jr. .... H01R 13/26  
 439/660  
 5,837,071 A 11/1998 Andersson et al.  
 6,196,636 B1 3/2001 Mills et al.  
 6,554,651 B2 \* 4/2003 Crane, Jr. .... H01R 13/26  
 439/660  
 6,758,530 B2 7/2004 Sollami  
 D627,804 S 11/2010 Fader et al.  
 8,007,049 B2 8/2011 Fader et al.  
 8,701,799 B2 4/2014 Hall et al.  
 8,950,517 B2 2/2015 Hall et al.  
 9,200,483 B2 12/2015 Gavia et al.

**OTHER PUBLICATIONS**

Notice in Japanese Design Application No. 2015-015001, dated Nov. 16, 2015.  
 Notice in Japanese Design Application No. 2015-015002, dated Nov. 16, 2015.  
 Notice in Japanese Design Application No. 2015-015004, dated Nov. 16, 2015.  
 Notice in Japanese Design Application No. 2015-015005, dated Nov. 16, 2015.  
 Notice of Allowance in Taiwanese Design Application No. 105300044, dated May 30, 2016.  
 Office Action issues in related Design U.S. Appl. No. 29/648,971, dated Oct. 3, 2019.

\* cited by examiner

FIG. 1

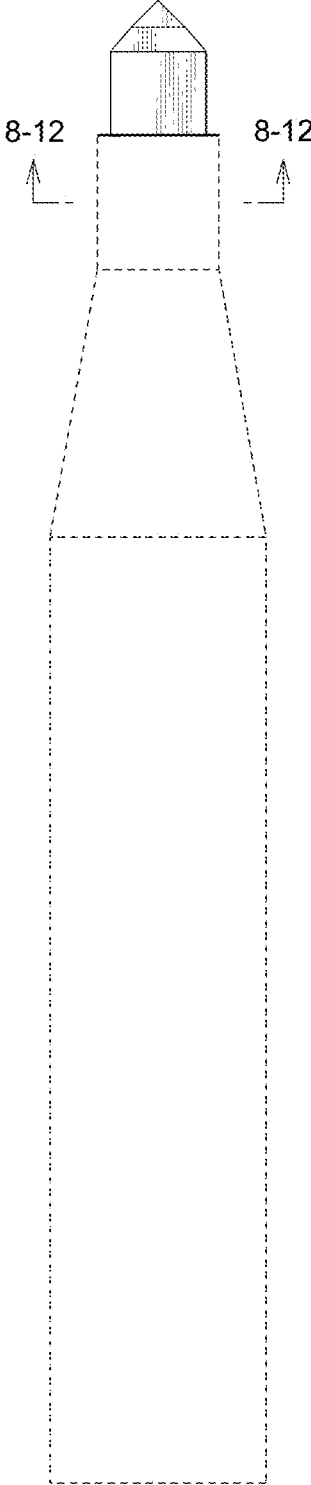

FIG. 2

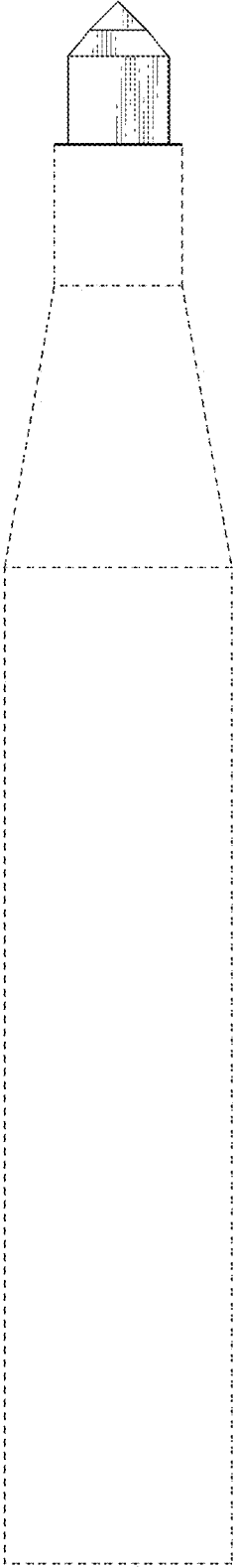

FIG. 3

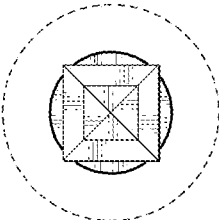

FIG. 4

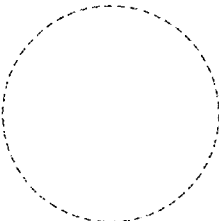

FIG. 5

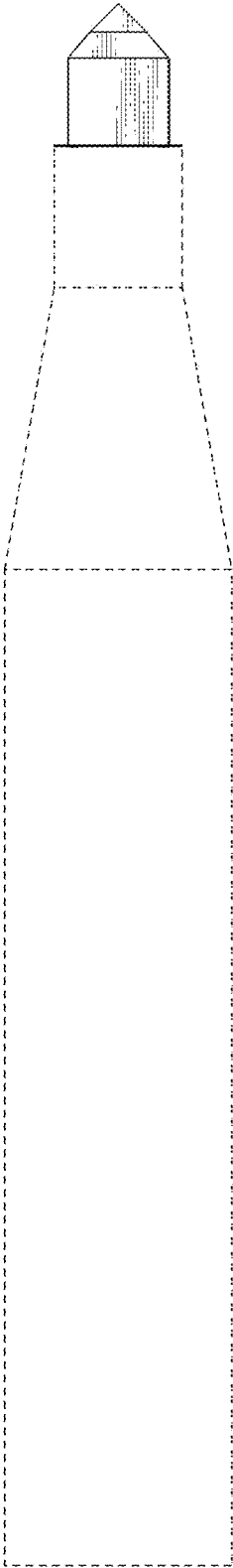

FIG. 6

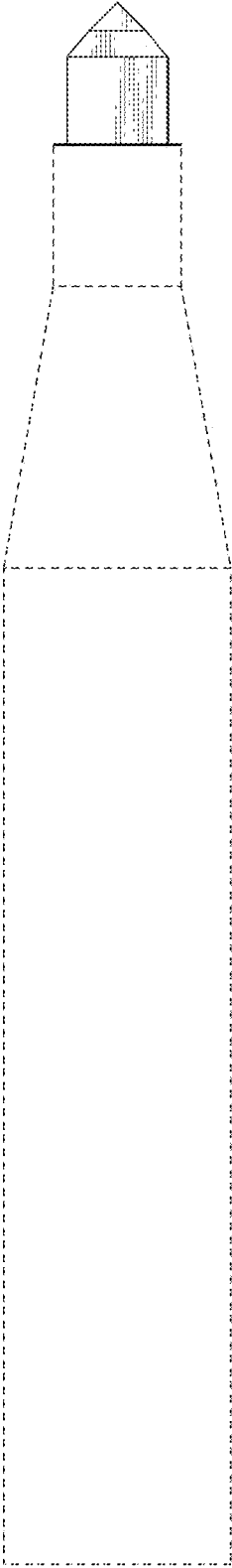

FIG. 7

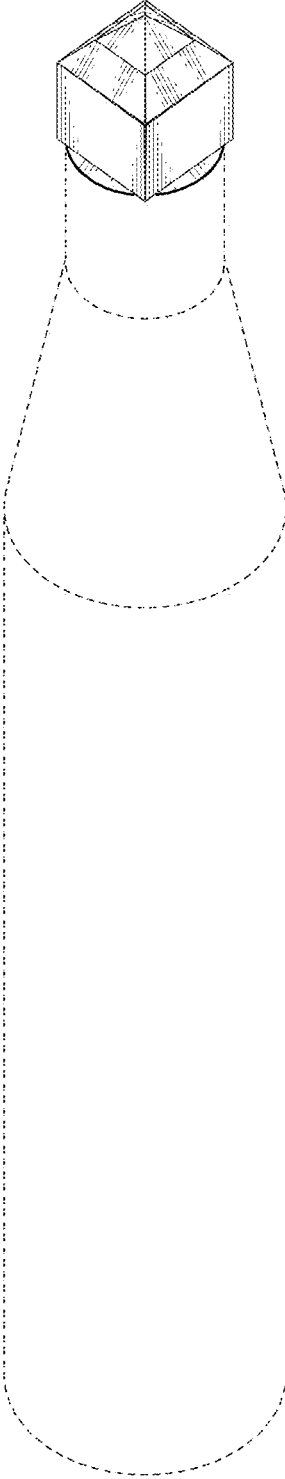

FIG. 8

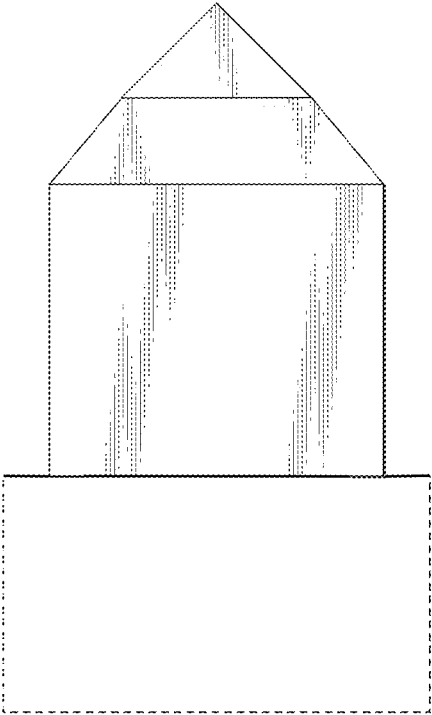

FIG. 9

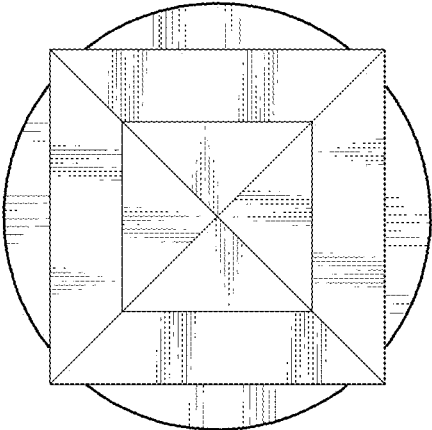

FIG. 10

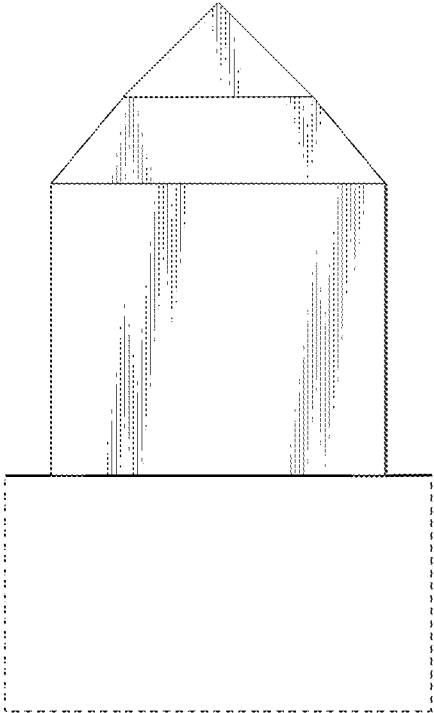

FIG. 11

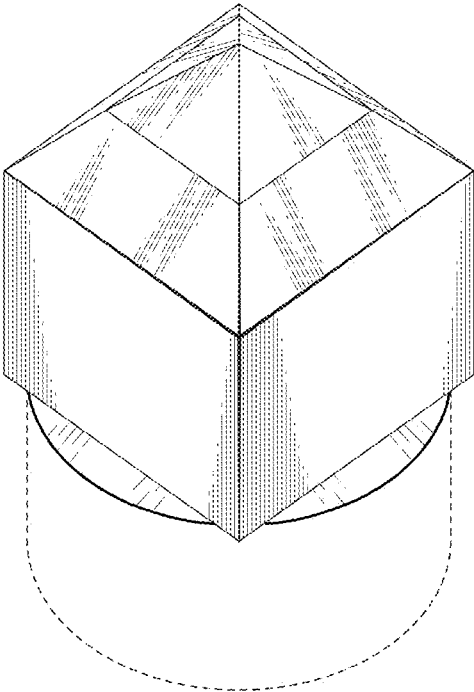

FIG. 12

