



US0D1008563S

(12) **United States Design Patent**
Minorini

(10) **Patent No.:** **US D1,008,563 S**

(45) **Date of Patent:** **** Dec. 19, 2023**

(54) **PACKAGING CASE FOR COSMETIC PRODUCTS**

(71) Applicant: **Euroitalia S.r.l.**, Cavenago di Brianza (IT)

(72) Inventor: **Massimiliano Minorini**, Milan (IT)

(73) Assignee: **EUROITALIA S.r.l.**, Cavenago di Brianza (IT)

(**) Term: **15 Years**

(21) Appl. No.: **35/515,009**

(22) Filed: **Jul. 28, 2022**

(80) **Hague Agreement Data**

Int. Filing Date: **Jul. 28, 2022**

Int. Reg. No.: **DM/222768**

Int. Reg. Date: **Jul. 28, 2022**

Int. Reg. Pub. Date: **Aug. 26, 2022**

(51) **LOC (14) Cl.** **28-03**

(52) **U.S. Cl.**
USPC **D28/83**
CPC **A45D 33/20** (2013.01)

(58) **Field of Classification Search**
USPC D28/73, 76, 83-84; D9/430, 432, 428
CPC A45D 33/20; A45D 33/26; A45D 33/28;
A45D 33/18; A45D 33/006; A45D
2040/0012; A45D 40/24; A45D
40/22-222

See application file for complete search history.

(56) **References Cited**

U.S. PATENT DOCUMENTS

D281,730 S *	12/1985	Phu	D28/78
D281,731 S *	12/1985	Phu	D28/83
D303,163 S *	8/1989	Bakic	D28/78
D321,415 S *	11/1991	Chen	D28/83
5,191,972 A *	3/1993	Helzer	A47G 1/12

206/0.8

D349,977 S *	8/1994	Shen	D28/78
D355,486 S *	2/1995	Ikeda	D28/78
5,655,553 A *	8/1997	Giese	A45D 40/22
				132/303
D386,615 S *	11/1997	Minami	D3/295
D409,801 S *	5/1999	Kim	D28/83
D444,596 S *	7/2001	Lai	D28/82
D465,305 S *	11/2002	Thorpe	D28/83
D473,681 S *	4/2003	Thorpe	D28/83
D474,889 S *	5/2003	Ko	D3/901
D476,116 S *	6/2003	Cohen	D28/83
D479,016 S *	8/2003	Sgariboldi	D28/78
D480,180 S *	9/2003	Lai	D28/83
D490,937 S *	6/2004	Ke	D28/79
D524,989 S *	7/2006	Lombardi	D28/82
D627,931 S *	11/2010	Barresi	D28/83

(Continued)

Primary Examiner — Richard E Chilcot

(74) *Attorney, Agent, or Firm* — AMSTER, ROTHSTEIN & EBENSTEIN LLP

(57) **CLAIM**

The ornamental design for a packaging case for cosmetic products, as shown and described.

DESCRIPTION

2. Packaging case for cosmetic products

2.1 : Perspective

2.2 : Top

2.3 : Front

2.4 : Right

2.5 : Back

2.6 : Left

2.7 : Bottom

2.8 : Top

2.9 : Right

2.10 : Top

2.11 : Right

Name of the product incorporating the design: packaging cases for cosmetic products; the purpose of the product: cosmetics packaging and storage; the main design points: the shape of the products; the pictures best illustrating the main point: perspective views.

1 Claim, 11 Drawing Sheets

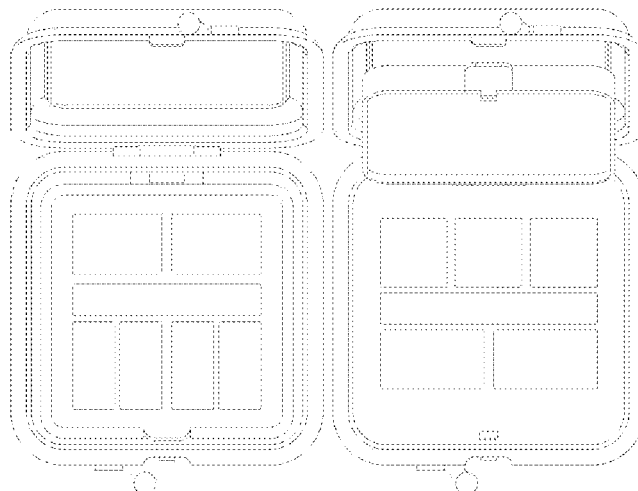

(56)

References Cited

U.S. PATENT DOCUMENTS

D635,303 S *	3/2011	Chung	D28/83	D932,704 S *	10/2021	Huang	D28/83
D687,634 S *	8/2013	Greenfield	D28/83	D933,955 S *	10/2021	Sung	D3/901
D718,904 S *	12/2014	Parker	D28/83	D934,504 S *	10/2021	Huerta	D28/83
D723,742 S *	3/2015	Shteytsel	D28/83	D935,764 S *	11/2021	Lu	D3/205
D752,290 S *	3/2016	Beilman	D3/901	D990,785 S *	6/2023	Pan	D28/83
D757,434 S *	5/2016	Beilman	D3/901	D990,865 S *	7/2023	Yan	D3/205
D803,481 S *	11/2017	Reiner	D28/87	2010/0051049 A1 *	3/2010	Jaworski	A45D 40/24 132/296
D815,358 S *	4/2018	Wolfe	D28/83	2011/0253167 A1 *	10/2011	Shteytsel	A45D 40/24 132/314
D830,637 S *	10/2018	Yoo	A45D 33/00 D28/83	2012/0000926 A1 *	1/2012	Ki	B65D 51/18 220/826
D831,275 S *	10/2018	Maynard	D28/83	2012/0055503 A1 *	3/2012	Kuo	A45D 33/006 132/293
D837,453 S *	1/2019	Angles-D'Auriac	D28/83	2013/0061867 A1 *	3/2013	Kim	A45D 40/18 132/293
D839,587 S *	2/2019	Beilman	D3/205	2013/0133686 A1 *	5/2013	Shteytsel	A45D 33/22 29/428
D843,660 S *	3/2019	Staab	D28/83	2014/0224275 A1 *	8/2014	Peterson	A45D 44/005 132/314
D850,006 S *	5/2019	Staab	D28/83	2014/0299151 A1 *	10/2014	Stroud	A45D 33/008 132/315
10,362,823 B1 *	7/2019	Hill	A41G 5/02	2016/0007714 A1 *	1/2016	Eberlein	A45D 33/008 220/505
D856,589 S *	8/2019	Park	D28/83	2016/0270507 A1 *	9/2016	Thompson	A45D 33/006
D863,685 S *	10/2019	Staab	D28/83				
D880,071 S *	3/2020	Weinrich	D28/83				
D887,085 S *	6/2020	Lin	D28/83				
D913,594 S *	3/2021	Zhang	D28/83				
D917,098 S *	4/2021	Huang	D3/901				
D918,478 S *	5/2021	McGrath	D28/83				
D919,891 S *	5/2021	Huang	D3/901				

* cited by examiner

2.1

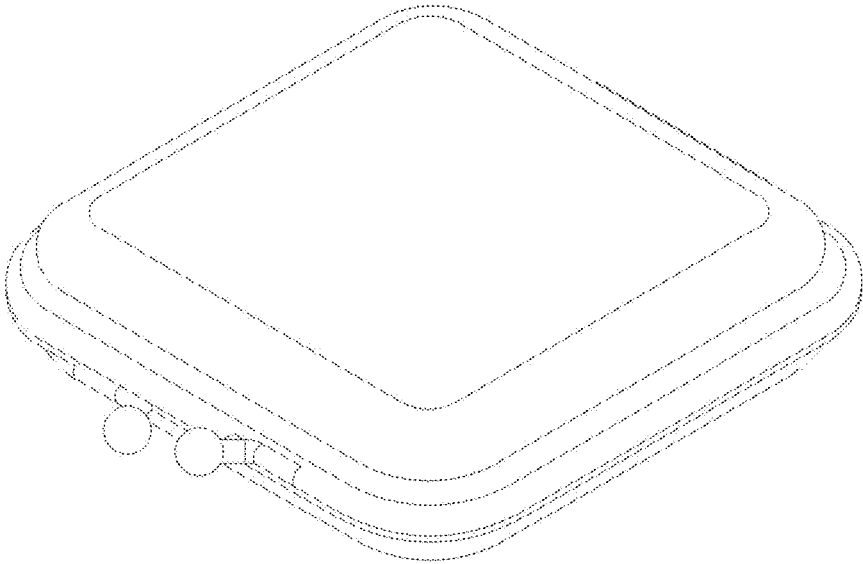

2.2

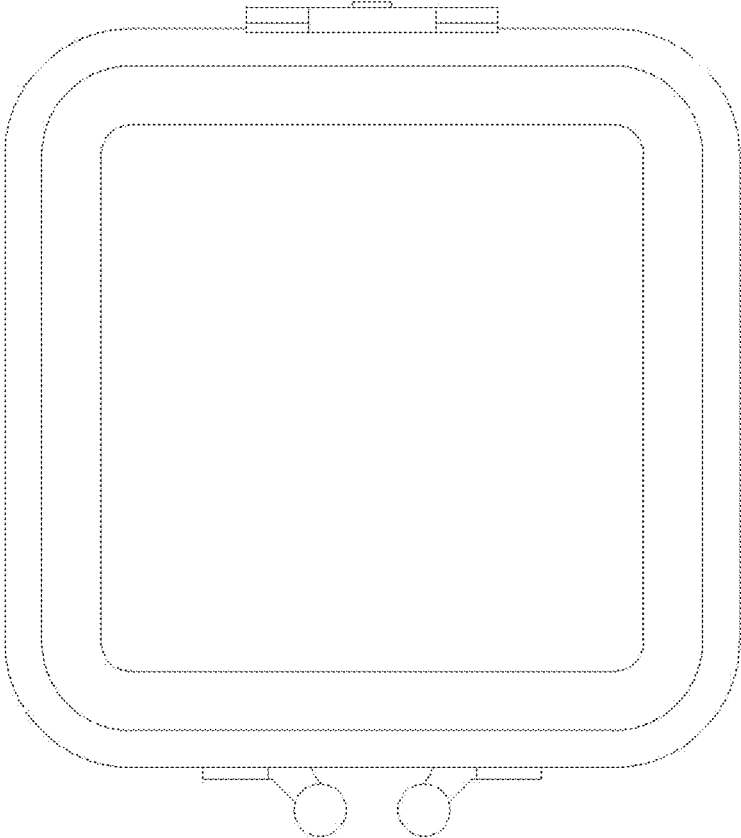

2.3

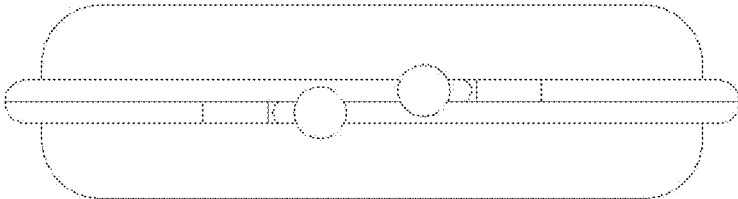

2.4

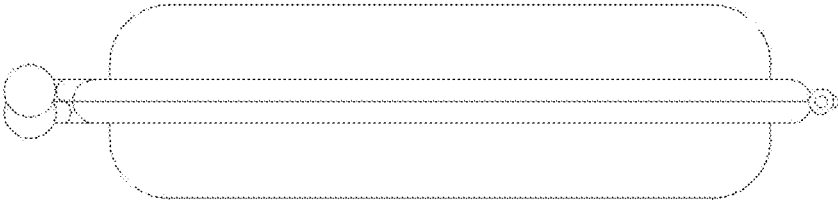

2.5

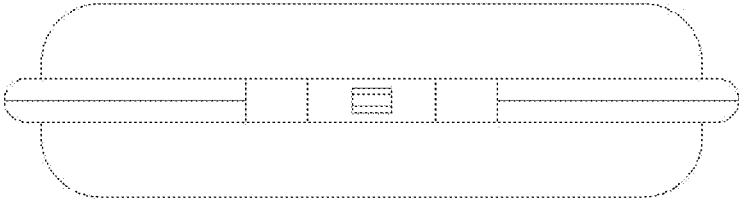

2.6

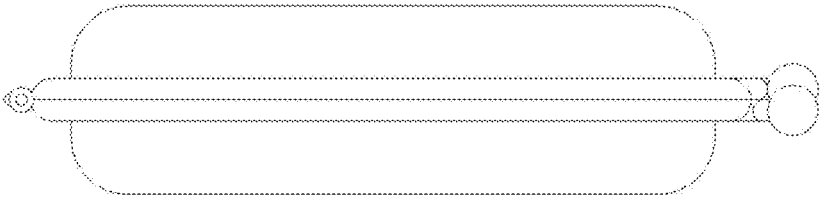

2.7

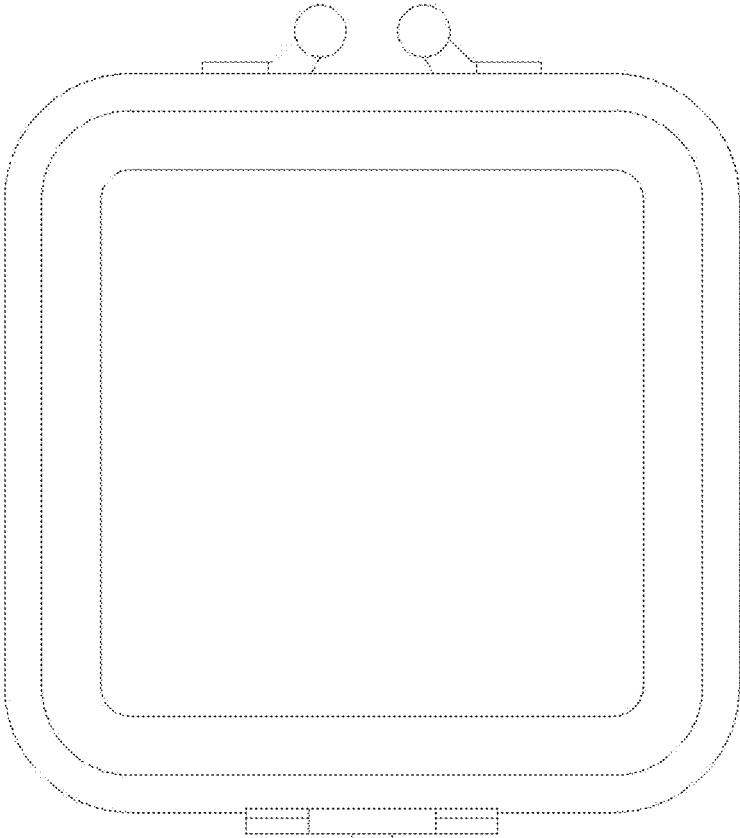

2.8

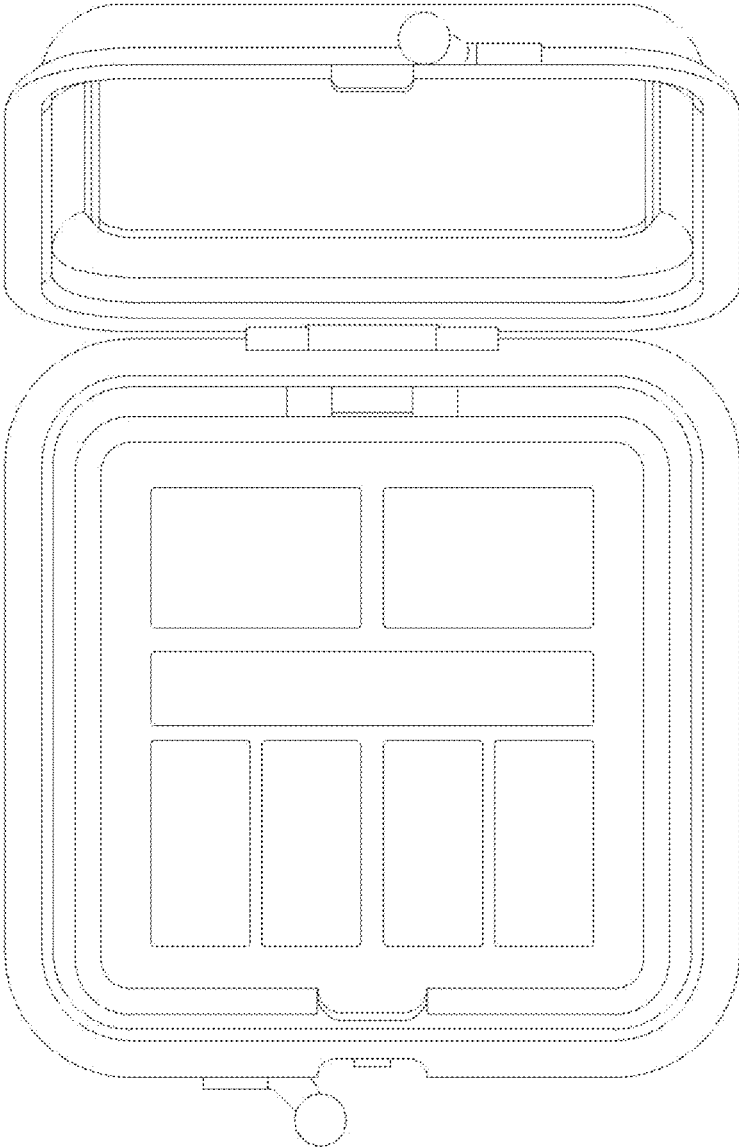

2.9

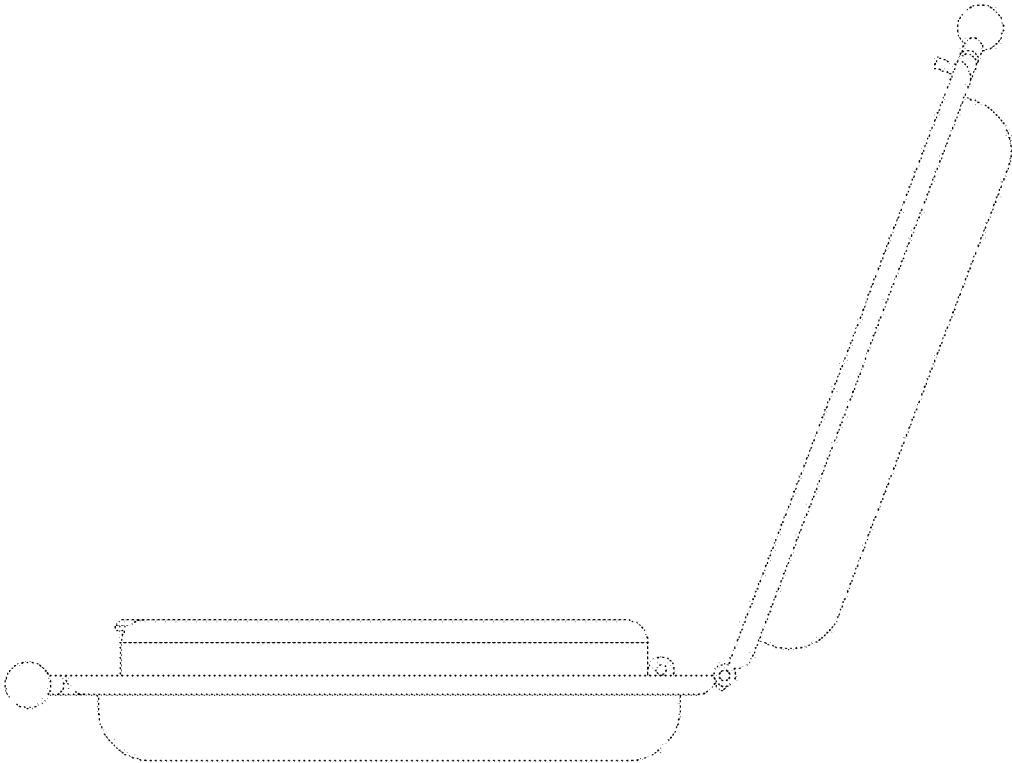

2.10

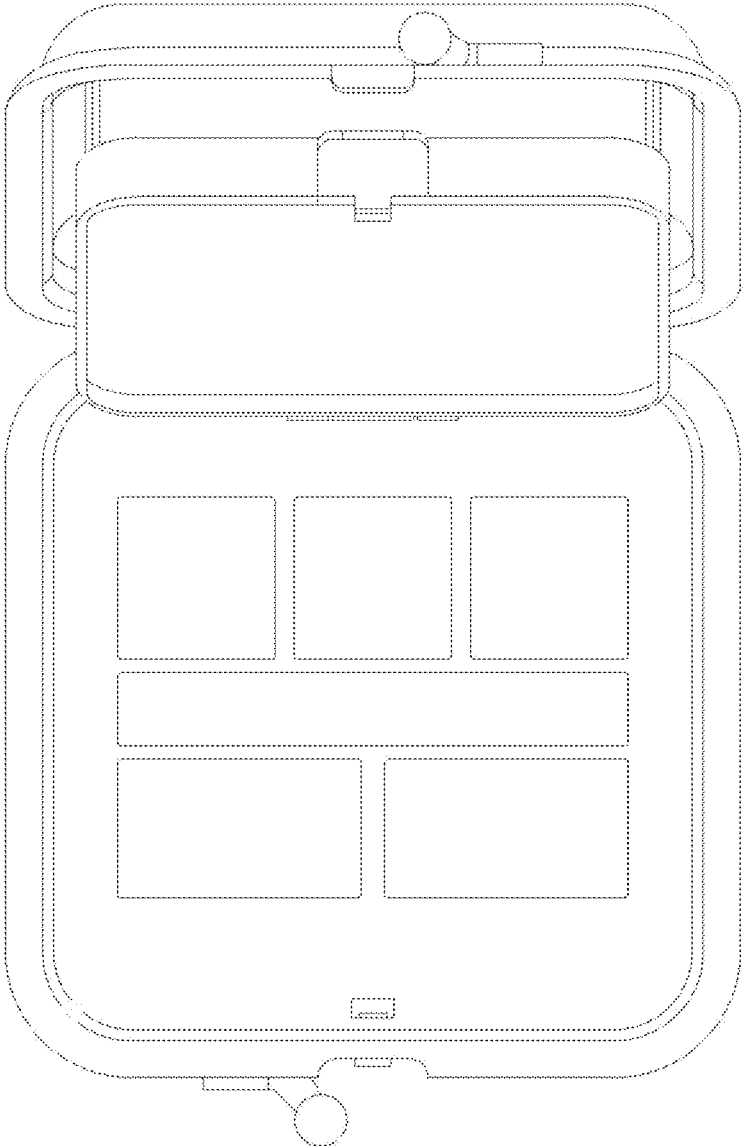

2.11

