



US00D960449S

(12) **United States Design Patent**
Du

(10) **Patent No.:** **US D960,449 S**

(45) **Date of Patent:** **** Aug. 9, 2022**

(54) **HAIR STRAIGHTENING BRUSH**
(71) Applicant: **Quzhi Hairdressing Supplies**
(Shenzhen) Co., Ltd, Shenzhen (CN)

D168,917 S *	2/1953	Snyder	D4/136
D197,696 S *	3/1964	Vallis	15/186
D881,579 S *	4/2020	Gao	D28/35
D895,972 S *	9/2020	Janowick	D28/35
D922,773 S *	6/2021	Zhou	D28/35
2020/0268136 A1 *	8/2020	Richmond	A46B 9/025

(72) Inventor: **Yufeng Du, Zaoyang (CN)**

(**) Term: **15 Years**

FOREIGN PATENT DOCUMENTS

(21) Appl. No.: **29/790,319**

CN	304083882	*	3/2017
GB	9003094952-0001	*	5/2016

(22) Filed: **Nov. 18, 2021**

* cited by examiner

(51) **LOC (13) Cl.** **28-03**

Primary Examiner — Karen E Eldridge Powers

(52) **U.S. Cl.** **D28/35; D4/100**
USPC

(58) **Field of Classification Search**
USPC D4/100, 102, 117, 121, 127, 128, 130,
D4/131, 132, 133, 134, 135, 136, 138,
D4/199; D28/24, 25, 26, 28, 30, 35
CPC .. A46B 5/02; A46B 9/02; A46B 9/023; A46B
13/02; A46B 2200/104; A46B 15/003;
A46B 15/0022; A46B 15/0051
See application file for complete search history.

(57) **CLAIM**

The ornamental design for a hair straightening brush, as shown and described.

DESCRIPTION

FIG. 1 is a top, front and right side perspective view of a hair straightening brush showing my new design;
FIG. 2 is a front elevation view thereof;
FIG. 3 is a rear elevation view thereof;
FIG. 4 is a left side elevation view thereof;
FIG. 5 is a right side elevation view thereof;
FIG. 6 is a top plan view thereof; and,
FIG. 7 is a bottom plan view thereof.

(56) **References Cited**

U.S. PATENT DOCUMENTS

D154,542 S *	7/1949	Hershey	D4/100
D168,916 S *	2/1953	Snyder	D4/136

1 Claim, 7 Drawing Sheets

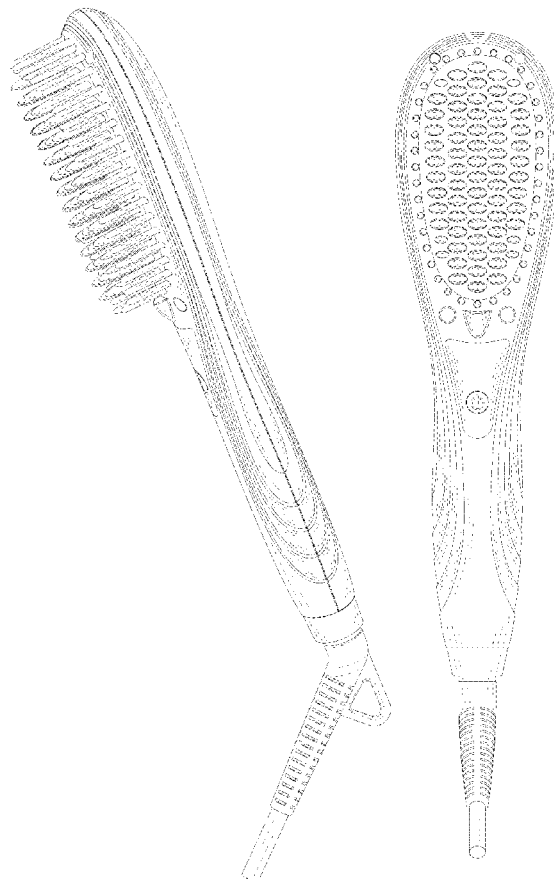

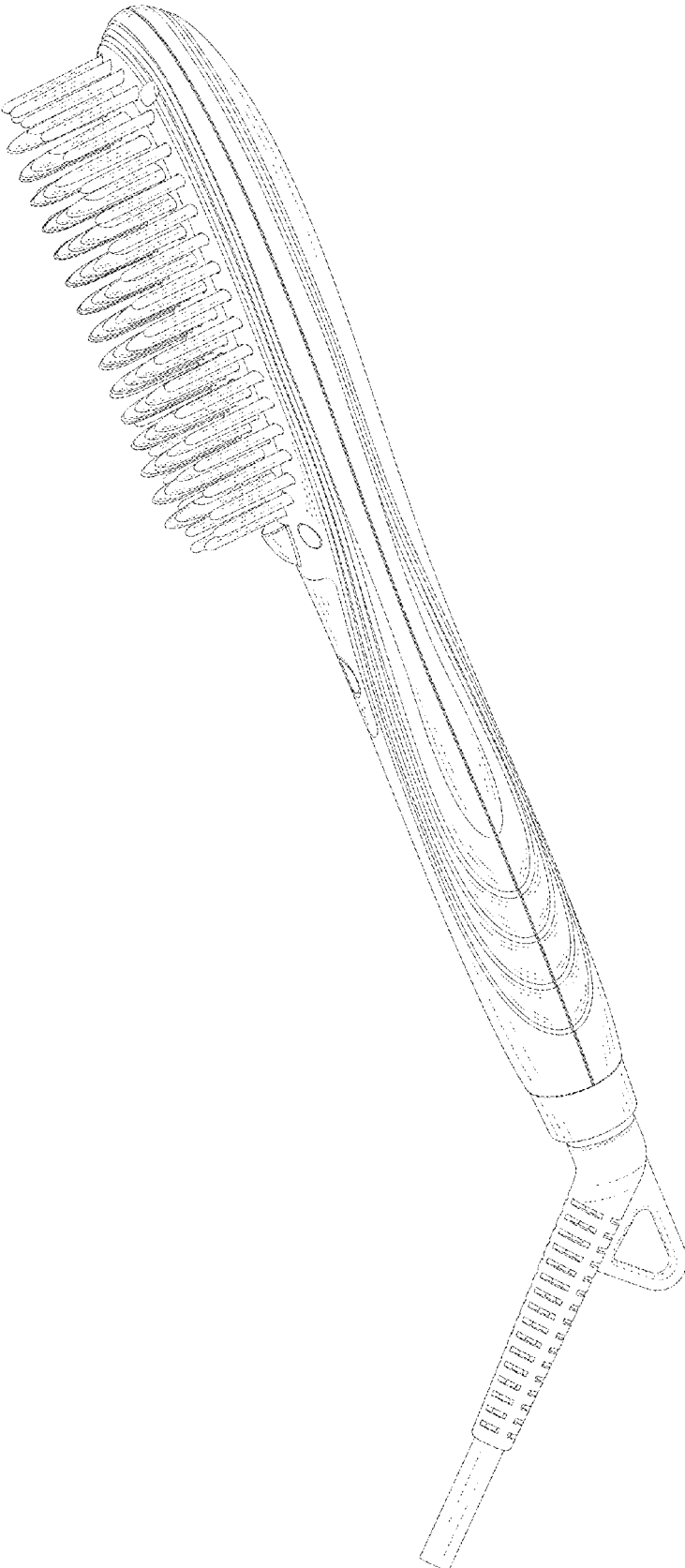

FIG. 1

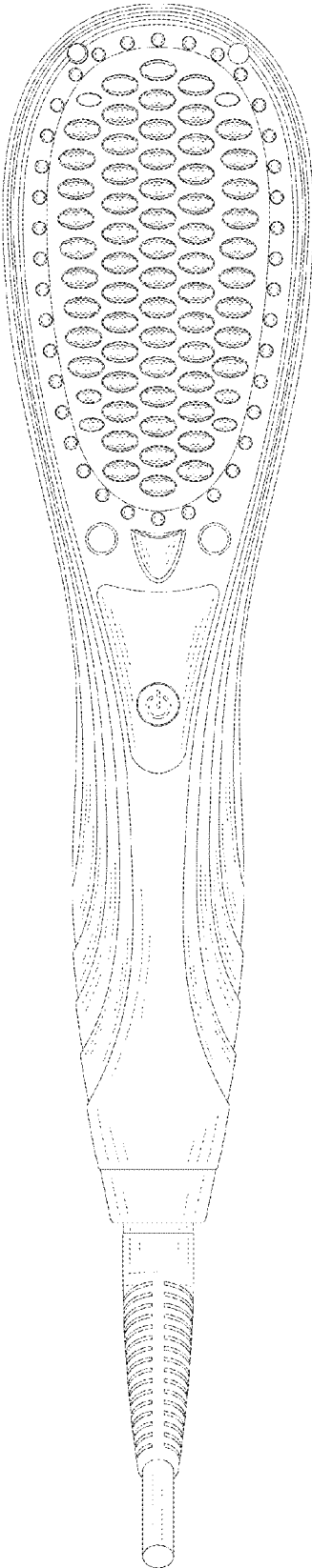

FIG. 2

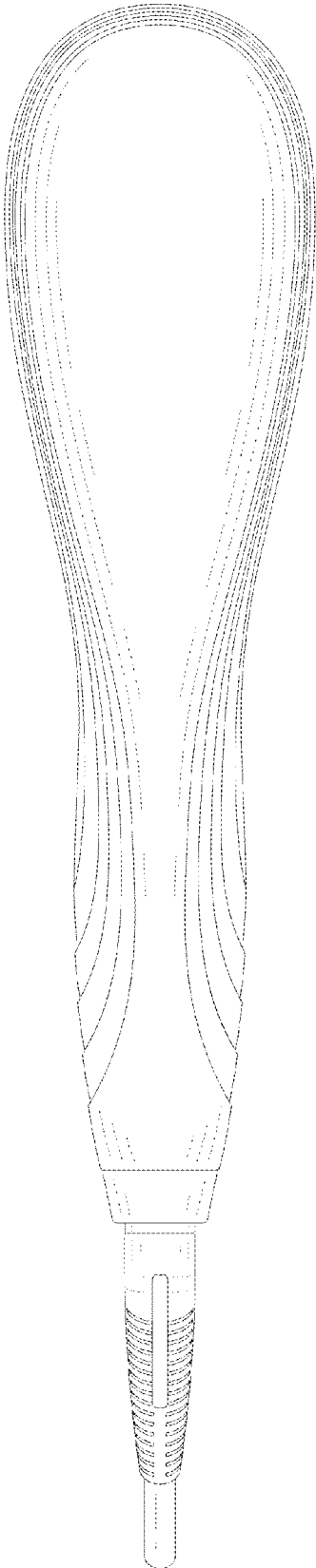

FIG. 3

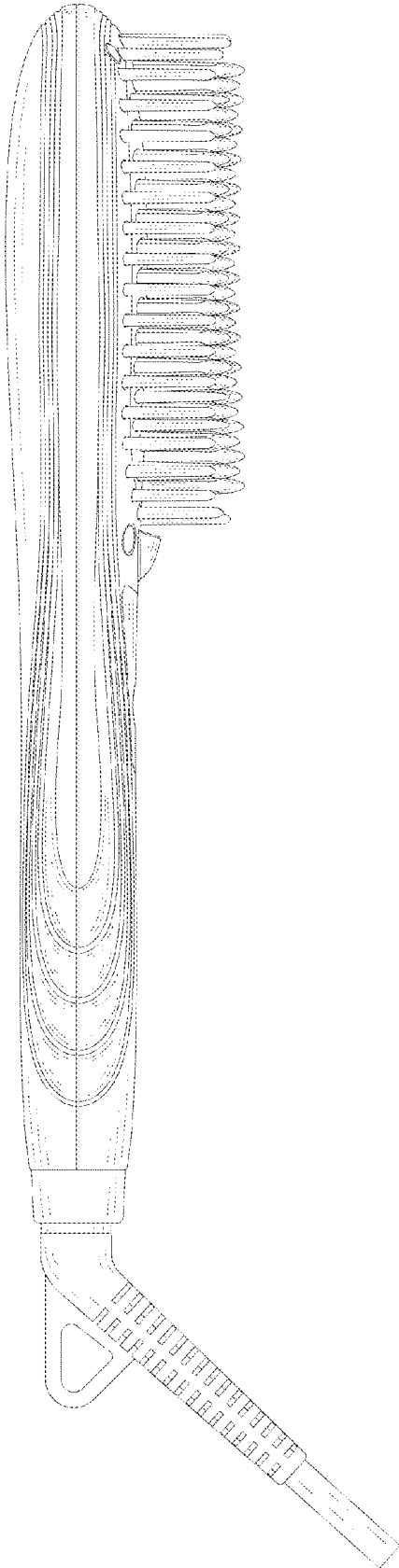

FIG. 4

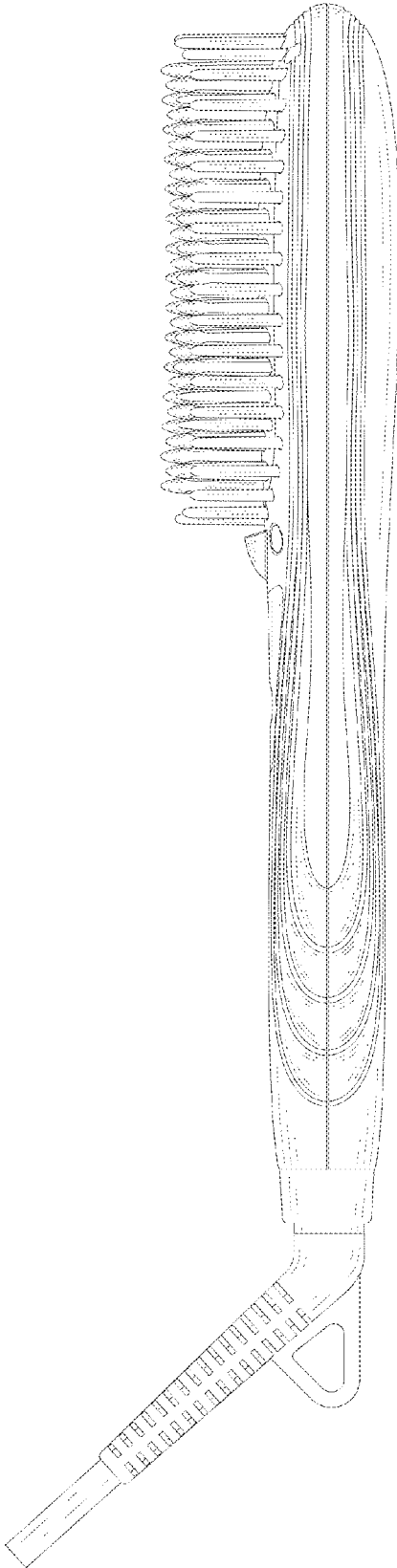

FIG. 5

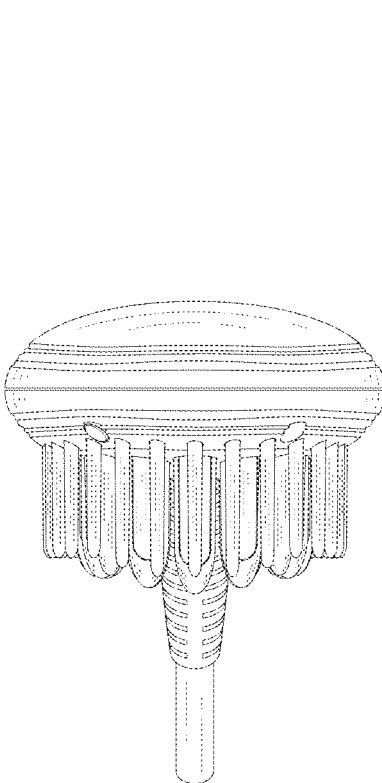

FIG. 6

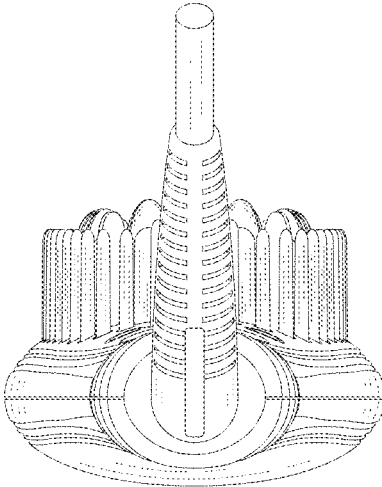

FIG. 7