



US00D786310S

(12) **United States Design Patent**
Southwell et al.

(10) **Patent No.:** **US D786,310 S**

(45) **Date of Patent:** **** May 9, 2017**

(54) **MOWER BLADE**

(71) Applicant: **HUSQVARNA AB**, Huskvarna (SE)

(72) Inventors: **John Southwell**, Huntersville, NC (US); **David Briney**, Charlotte, NC (US)

(73) Assignee: **HUSQVARNA AB**, Huskvarna (SE)

(**) Term: **15 Years**

(21) Appl. No.: **29/544,776**

(22) Filed: **Nov. 6, 2015**

(51) **LOC (10) Cl.** **15-03**

(52) **U.S. Cl.**
USPC **D15/17**

(58) **Field of Classification Search**
USPC D15/14-18, 28, 32, 199; D8/4-12, 16, D8/20
CPC A01D 34/006; A01D 34/64; A01D 34/82; A01D 34/001; A01D 34/008; A01D 2101/00; A01D 34/828; A01D 34/74; A01D 34/78; A01D 34/824; A01D 43/00; A01D 43/063; A01D 34/00; A01D 34/43; A01D 34/63; A01D 34/661; A01D 34/664; A01D 42/005; A01D 42/04; A01D 43/077; A01D

(Continued)

(56) **References Cited**

U.S. PATENT DOCUMENTS

2,870,616 A 1/1959 Benson
3,780,509 A 12/1973 Woelffer

(Continued)

FOREIGN PATENT DOCUMENTS

GB 839674 A 6/1960
GB 2525499 A 10/2015

(Continued)

OTHER PUBLICATIONS

International Search Report and Written Opinion in the International patent application No. PCT/US2015/010952 mailed May 6, 2015.

(Continued)

Primary Examiner — Ian Simmons

Assistant Examiner — Khawaja Anwar

(74) *Attorney, Agent, or Firm* — Nelson Mullins Riley & Scarborough LLP

(57) **CLAIM**

The ornamental design for a mower blade, as shown and described.

DESCRIPTION

FIG. 1 is a top perspective view of a mower blade in accordance with a first embodiment of the present invention, showing our new design;

FIG. 2 is a top view of the thereof;

FIG. 3 is a bottom view thereof;

FIG. 4 is a front view thereof;

FIG. 5 is a rear view thereof;

FIG. 6 is a right side view thereof;

FIG. 7 is a left side view thereof;

FIG. 8 is a top perspective view of a mower blade in accordance with a second embodiment of the present invention;

FIG. 9 is a top view of the thereof;

FIG. 10 is a bottom view thereof;

FIG. 11 is a front view thereof;

FIG. 12 is a rear view thereof;

FIG. 13 is a right side view thereof; and,

FIG. 14 is a left side view thereof.

The broken lines of FIGS. 1-14 are illustrative of the visible environmental structure of the mower blade and form no part of the claimed design; the dash-dot broken lines in the figure views represent the boundaries of the claim and form no part of the claimed design.

1 Claim, 8 Drawing Sheets

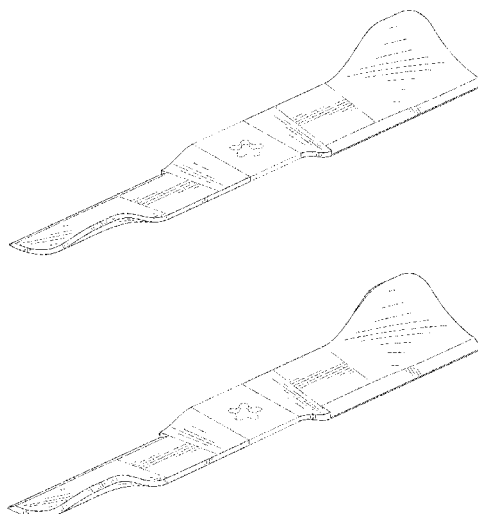

(58) **Field of Classification Search**

CPC 43/14; A01D 69/08; A01D 75/182; A01D
 34/005; A01D 34/03; A01D 34/412;
 A01D 34/416; A01D 34/4165; A01D
 34/4166; A01D 34/4168; A01D 34/47;
 A01D 34/53; A01D 34/67; A01D 34/69

See application file for complete search history.

D649,981	S	12/2011	Roth et al.
8,091,332	B2	1/2012	Hulsman et al.
8,539,745	B2	9/2013	Schmidt et al.
D694,781	S	12/2013	Roth
D694,782	S	12/2013	Roth
D710,396	S	8/2014	Nie
D723,589	S	3/2015	Nishihara et al.
9,113,595	B2	8/2015	Roth et al.
D759,126	S *	6/2016	Johnson A01D 34/736

(56) **References Cited**

U.S. PATENT DOCUMENTS

5,094,065	A	3/1992	Azbell	
D357,691	S	4/1995	Bryant	
5,501,068	A	3/1996	Martz	
5,615,542	A	4/1997	Thorud et al.	
6,052,979	A	4/2000	Tutschka	
6,367,235	B1	4/2002	Moynihan	
D482,700	S *	11/2003	Lancaster	D15/17
6,688,095	B2	2/2004	Wadzinski	
6,996,962	B1	2/2006	Sugden et al.	
7,065,946	B2	6/2006	Boeck et al.	
7,093,415	B2	8/2006	Kallevig et al.	
7,204,073	B1	4/2007	Chenevert	
D598,475	S	8/2009	Roth	
7,574,852	B1	8/2009	Loxterkamp et al.	
D609,251	S	2/2010	Roth	
D622,740	S	8/2010	Roth et al.	

D766,332	S *	9/2016	Poole	D15/17
D767,639	S *	9/2016	Johnson	D15/17
2005/0172601	A1	8/2005	Besogne	
2005/0229573	A1	10/2005	Curran	
2016/0037716	A1	2/2016	Johansson et al.	

FOREIGN PATENT DOCUMENTS

WO	2014152644	A1	9/2014
WO	2014152992	A2	9/2014
WO	2015016895	A1	2/2015

OTHER PUBLICATIONS

TORO, 'Toro Blade Adapter', <http://www.hy-capacity.com/index.php?page=Search&partid=55834>.

* cited by examiner

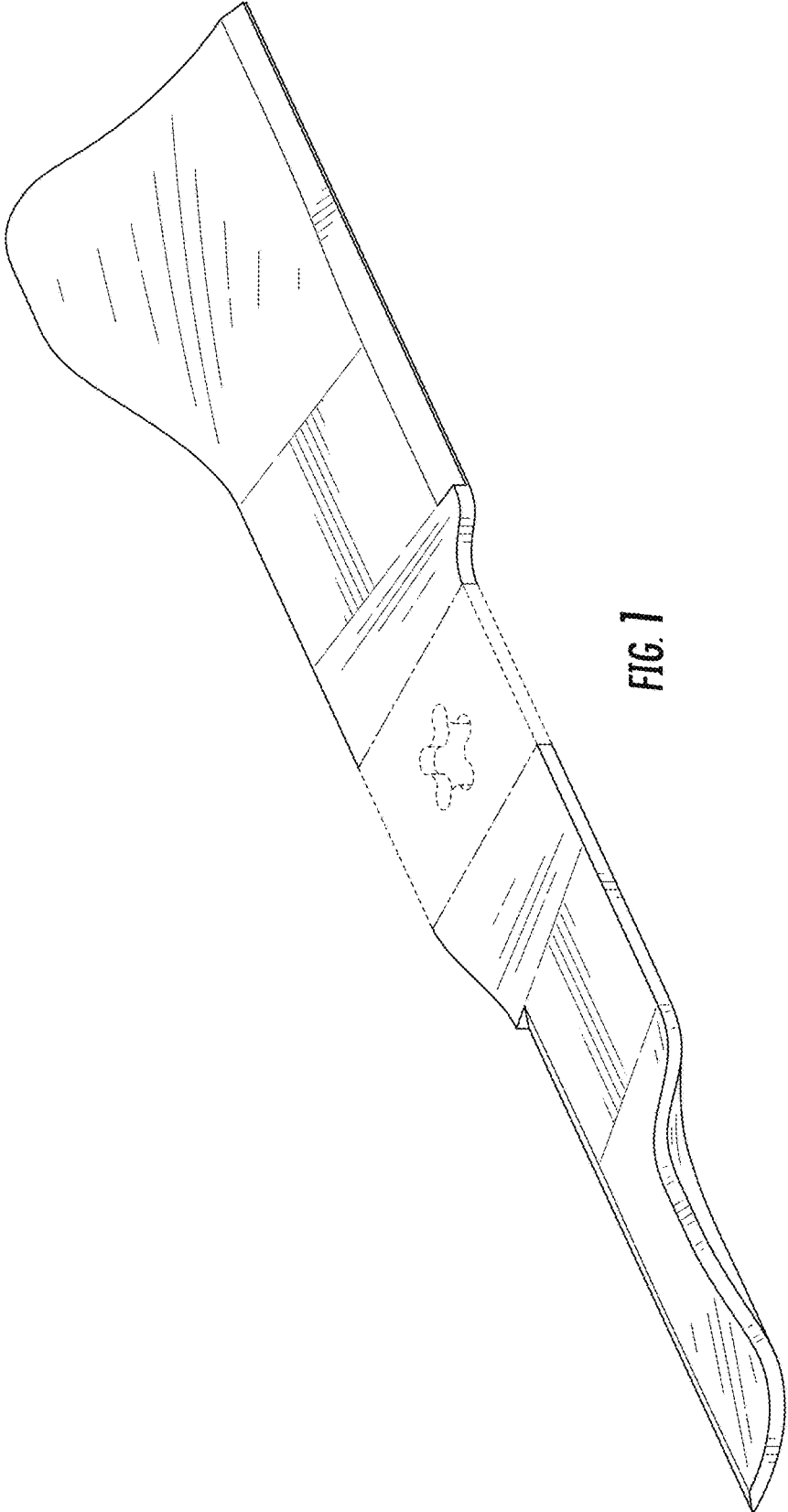

FIG. 1

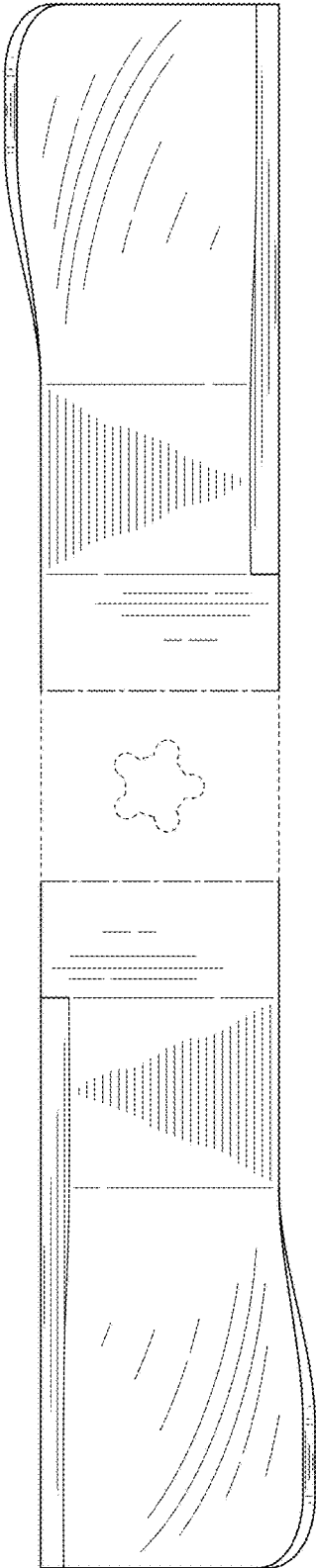

FIG. 2

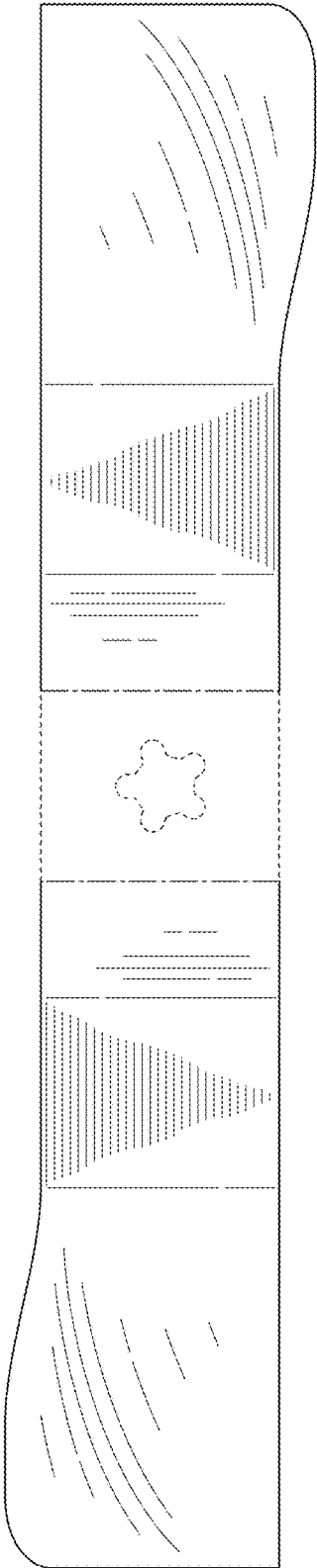

FIG. 3

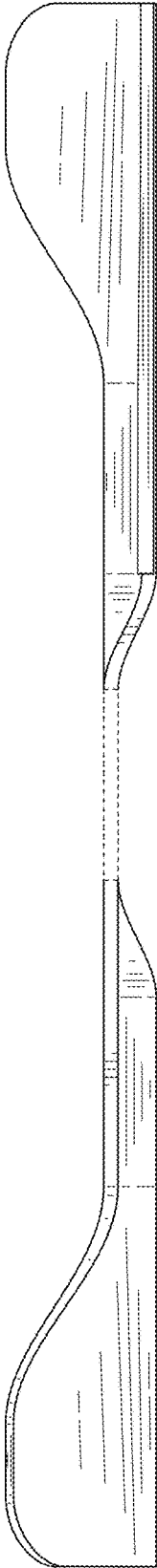

FIG. 4

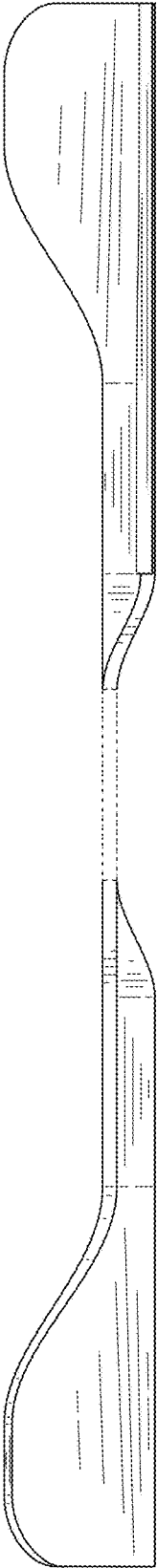

FIG. 5

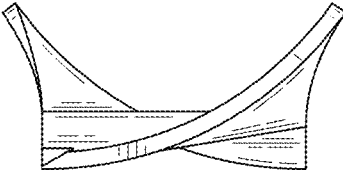

FIG. 6

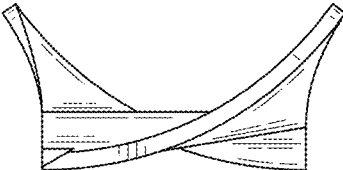

FIG. 7

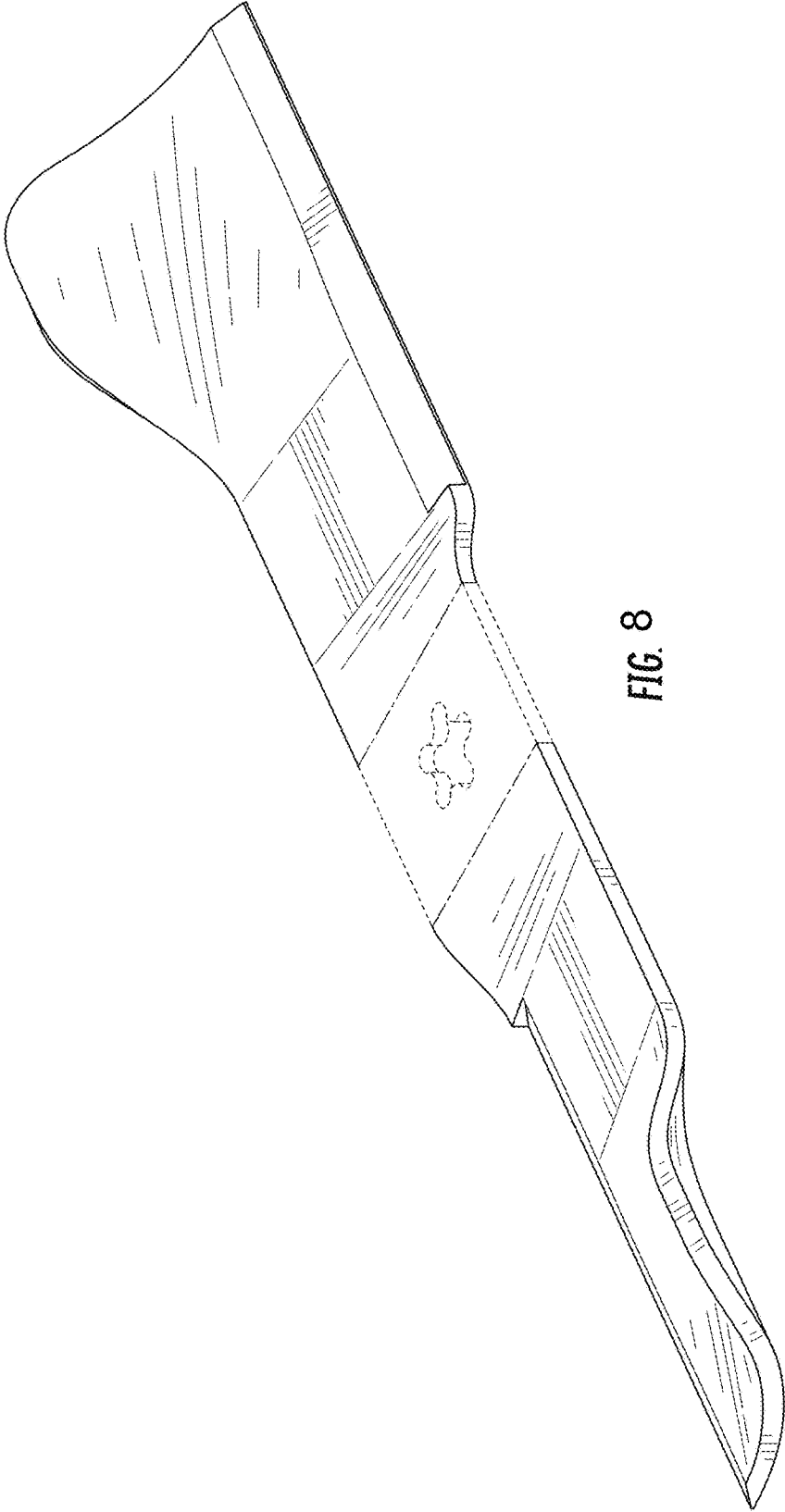

FIG. 8

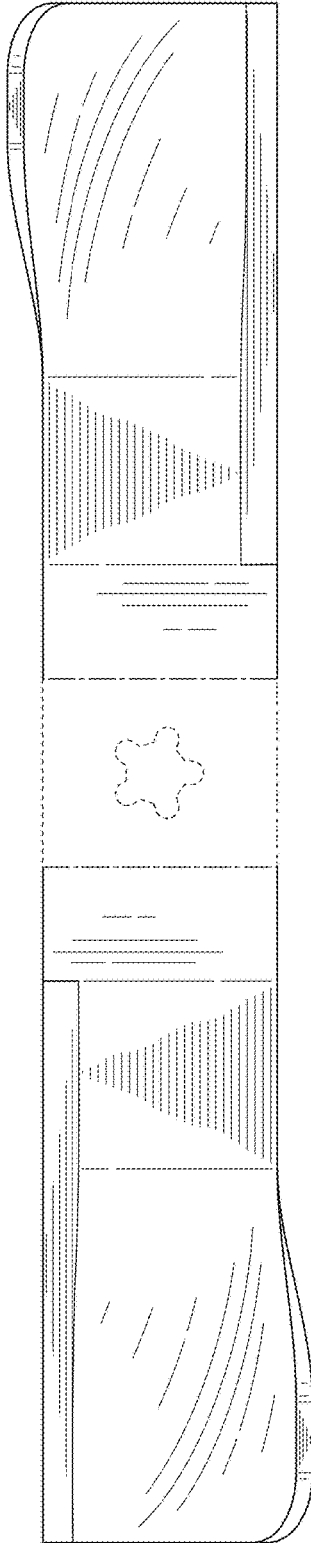

FIG. 9

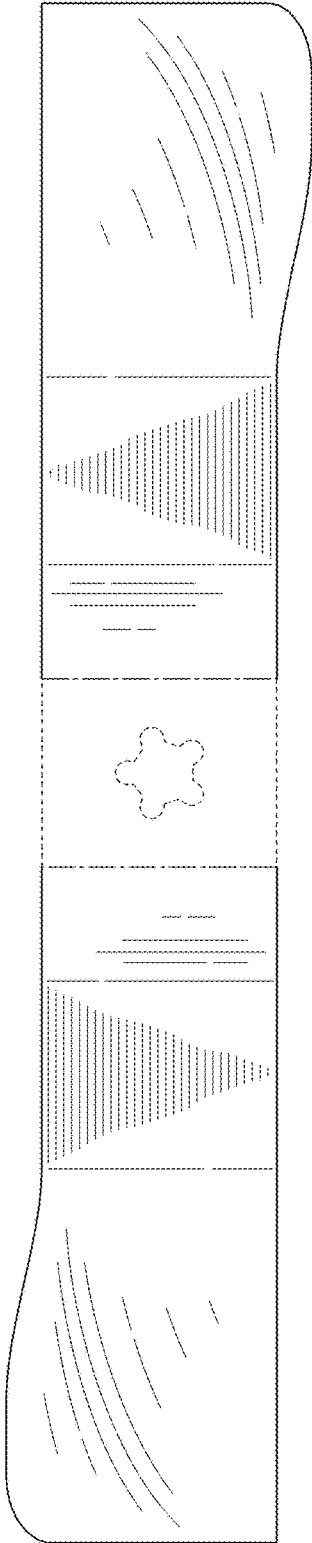

FIG. 10

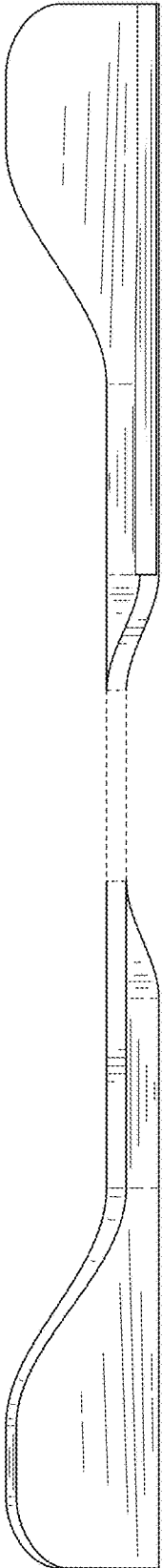

FIG. 11

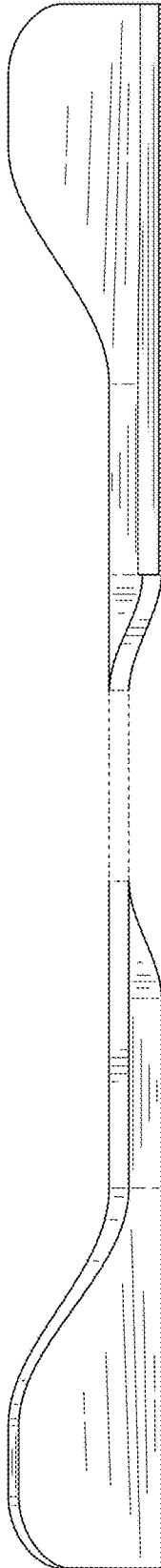

FIG. 12

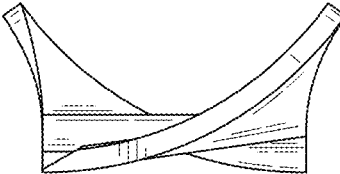

FIG. 13

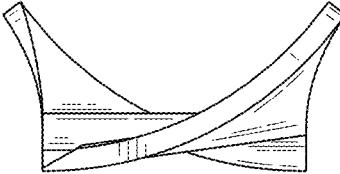

FIG. 14