



US00D727741S

(12) **United States Design Patent**
Handy

(10) **Patent No.:** **US D727,741 S**

(45) **Date of Patent:** **** Apr. 28, 2015**

(54) **BOTTLE**

(75) Inventor: **Francis J. Handy**, San Rafael, CA (US)

(73) Assignee: **Method Products, PBC**, San Francisco, CA (US)

(**) Term: **14 Years**

(21) Appl. No.: **29/416,589**

(22) Filed: **Mar. 23, 2012**

(51) **LOC (10) Cl.** **09-01**

(52) **U.S. Cl.**
USPC **D9/558**; D9/520; D9/574

(58) **Field of Classification Search**
USPC D9/516, 520-522, 529, 530, 537,
D9/541-544, 549, 550, 552, 558, 559, 565,
D9/571-575; 215/379, 381-385; 220/660,
220/669, 675

See application file for complete search history.

(56) **References Cited**

U.S. PATENT DOCUMENTS

D54,197 S *	11/1919	Conner	D9/767
D203,227 S	12/1965	Utley		
D236,802 S *	9/1975	McDonald	D9/558
D244,531 S *	5/1977	Klingaman	D23/225
D323,455 S	1/1992	Eichler		
D342,680 S	12/1993	Pereira et al.		
D342,903 S *	1/1994	Ricci	D9/545
D484,055 S	12/2003	Feigenbaum		
D496,262 S *	9/2004	Dretzka	D6/542
D522,369 S	6/2006	Penn		
D542,135 S	5/2007	Machmadow		
D577,126 S	9/2008	Woeste		
D608,213 S *	1/2010	Kuzma et al.	D9/573
D614,032 S	4/2010	Handy		
D615,404 S *	5/2010	Pitzer et al.	D9/500
D643,737 S	8/2011	Handy		

FOREIGN PATENT DOCUMENTS

GB 2089174 * 2/2000

OTHER PUBLICATIONS

“Foaming Hand Eucalyptus Mint,” <http://www.methodhome.com/all-products/green-herbaceous/eucalyptus-mint/563.aspx>, downloaded Apr. 29, 2010.

“Pro Chef Multi-Surface Kitchen Cleaner,” <http://www.methodhome.com/product/pro-chef-multi-surface-kitchen-cleaner/>, downloaded Oct. 20, 2010.

Co-pending U.S. Appl. No. 29/401,850, Inventor Francis J. Handy, filed Sep. 16, 2011 (Not Published).

Co-pending U.S. Appl. No. 29/361,7690, Inventor Francis J. Handy, filed May 14, 2011 (Not Published).

* cited by examiner

Primary Examiner — Derrick Holland

Assistant Examiner — Janice Lim

(74) *Attorney, Agent, or Firm* — Sterne, Kessler, Goldstein & Fox P.L.L.C.

(57) **CLAIM**

The ornamental design for a bottle, as shown and described.

DESCRIPTION

FIG. 1 is a front perspective view of a first embodiment of a bottle showing my new design;

FIG. 2 is a front view thereof, the rear view being a mirror image thereof;

FIG. 3 is a right side view thereof;

FIG. 4 is a left side view thereof;

FIG. 5 is a top plan view thereof;

FIG. 6 is a bottom plan view thereof;

FIG. 7 is a bottom perspective view thereof;

FIG. 8 is a front perspective view of a second embodiment of a bottle showing my new design;

FIG. 9 is a front view thereof, the rear view being a mirror image thereof;

FIG. 10 is a left side view thereof;

FIG. 11 is a right side view thereof;

FIG. 12 is a top plan view thereof;

FIG. 13 is a bottom plan view thereof; and,

FIG. 14 is a bottom perspective view thereof.

The broken lines in FIGS. 1-14 show unclaimed subject matter only and form no part of the claimed design.

1 Claim, 9 Drawing Sheets

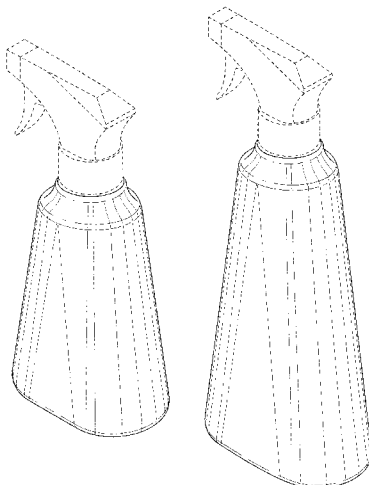

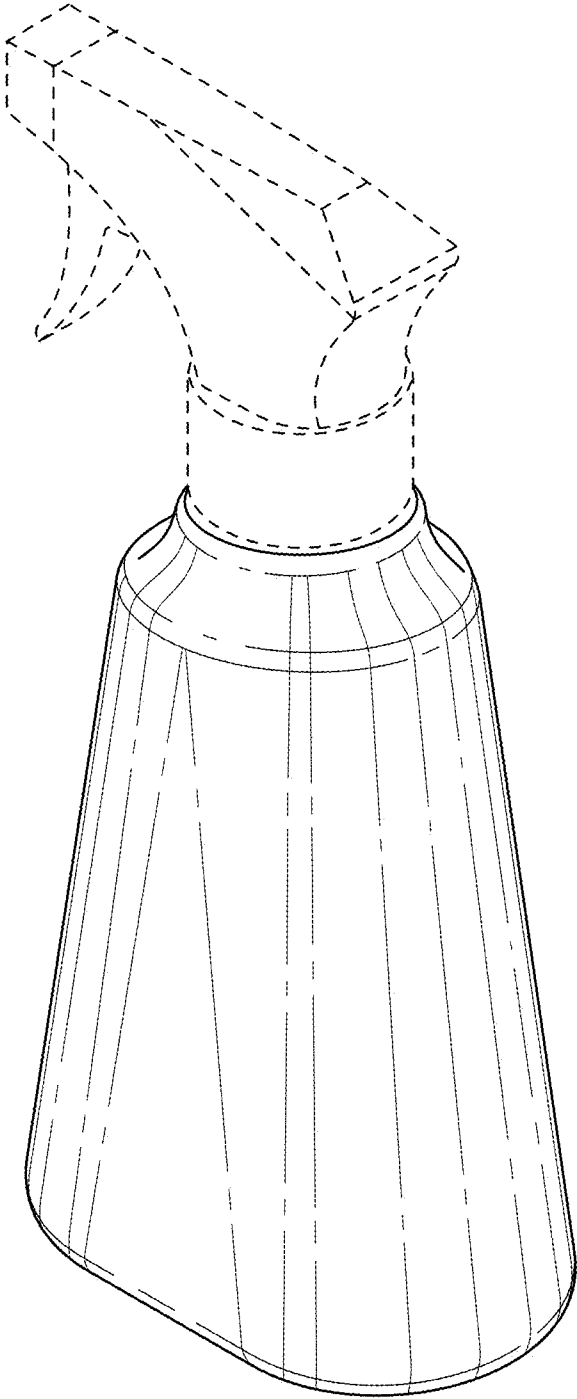

FIG. 1

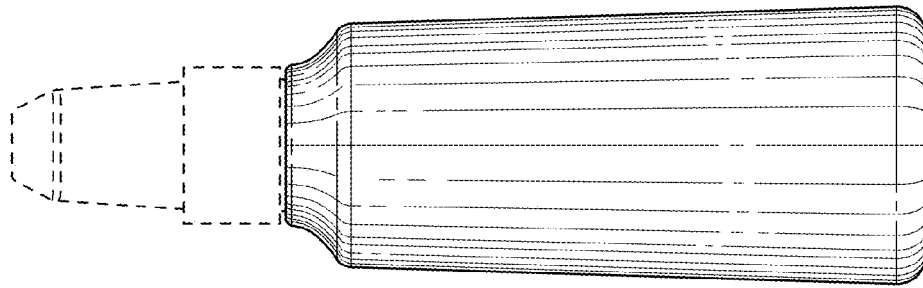

FIG. 3

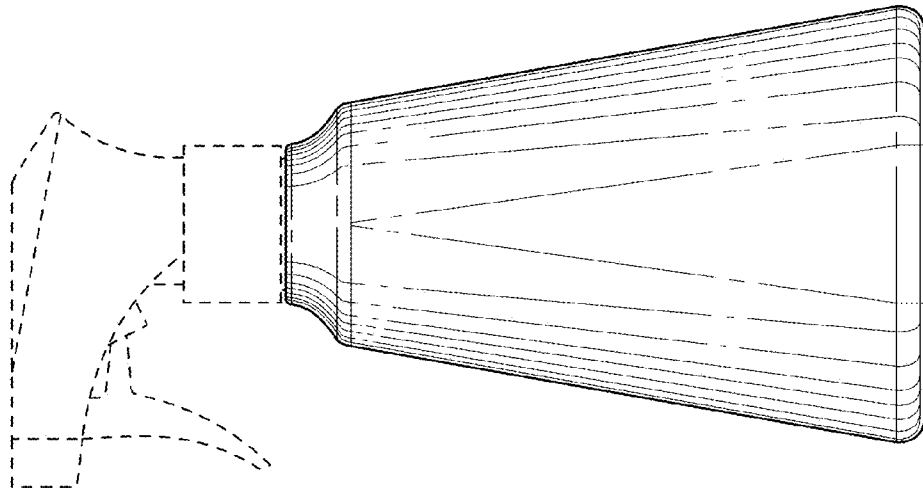

FIG. 2

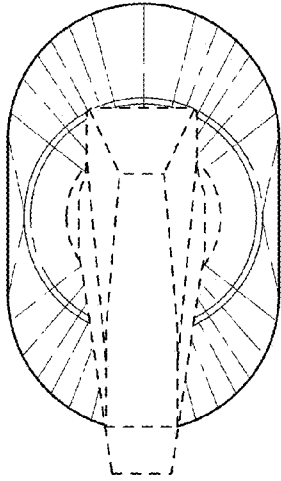

FIG. 5

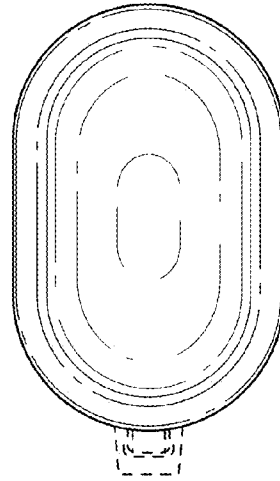

FIG. 6

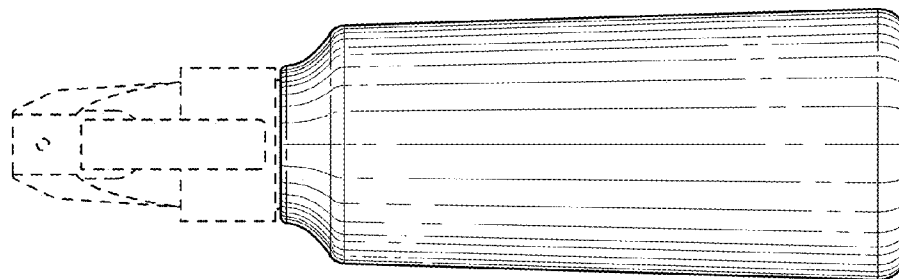

FIG. 4

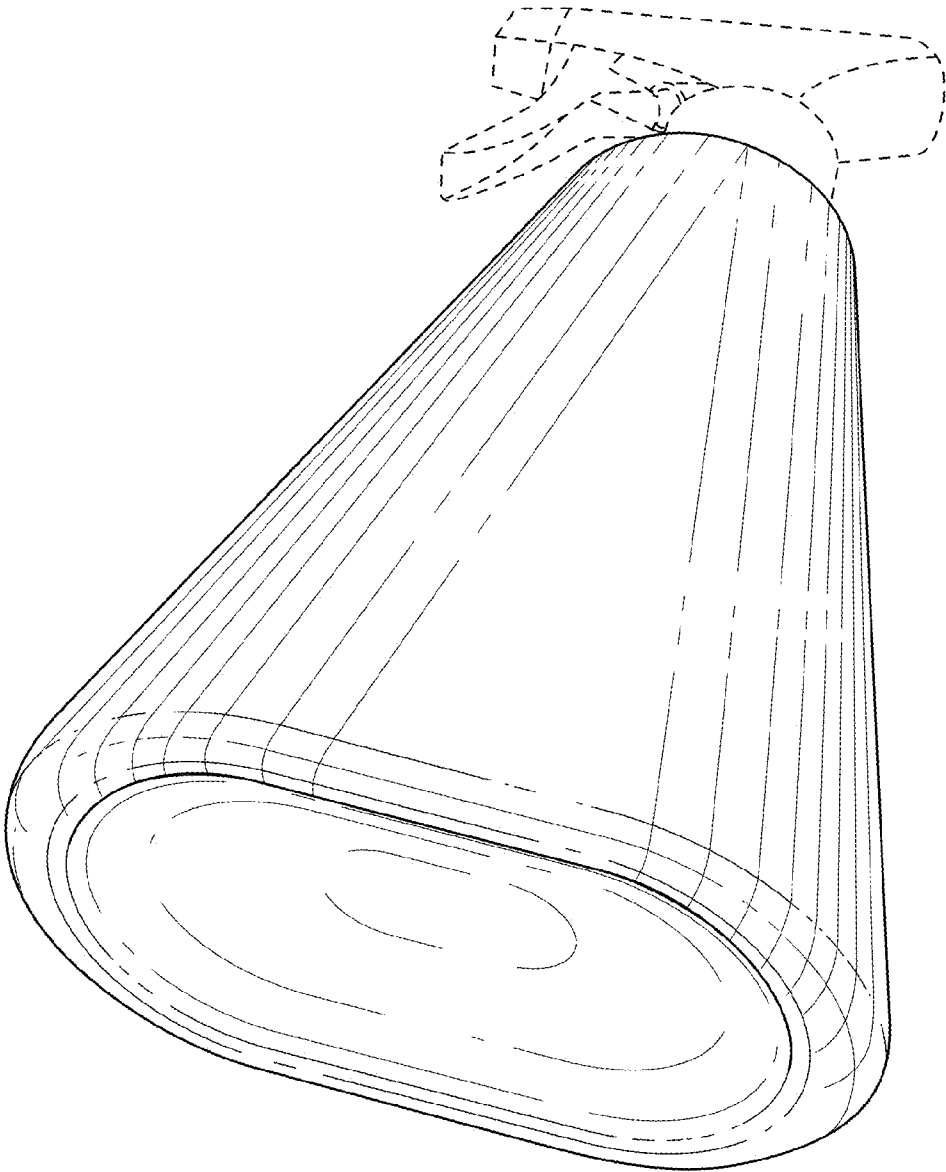

FIG. 7

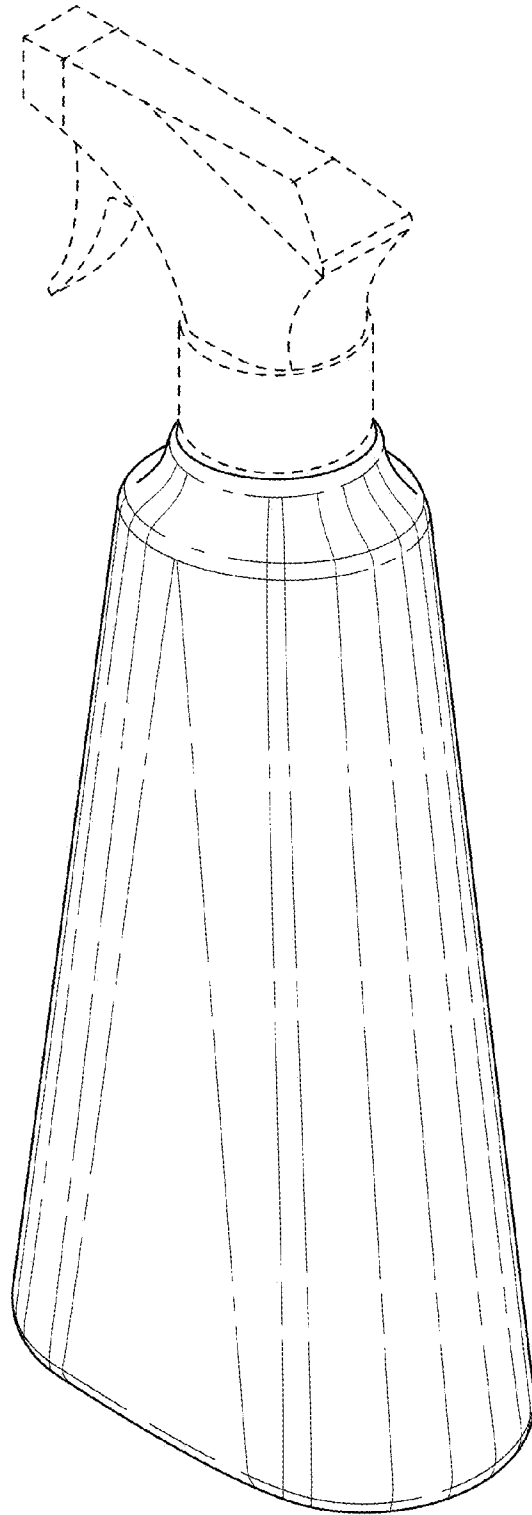

FIG. 8

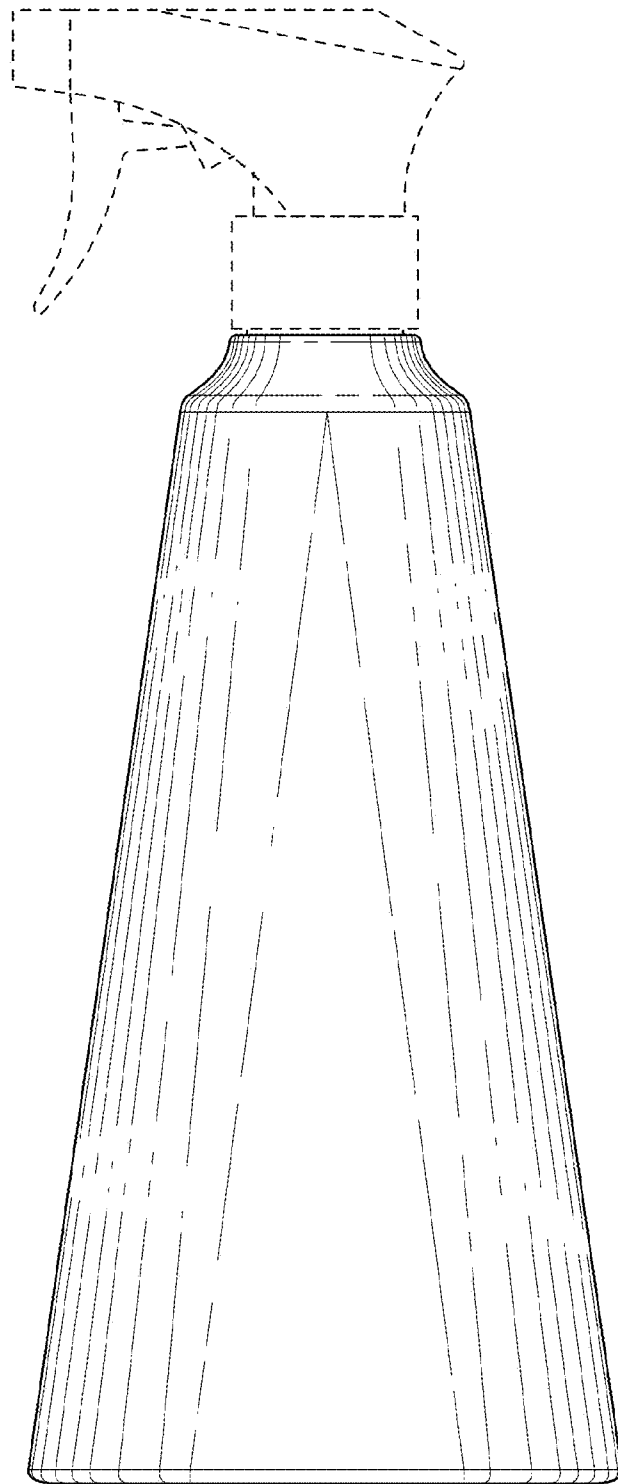

FIG. 9

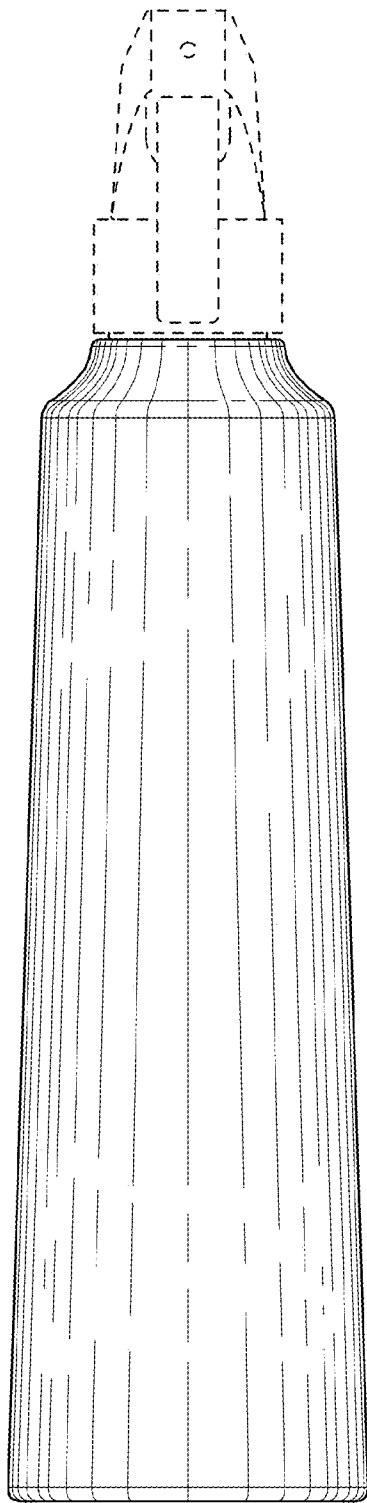

FIG. 10

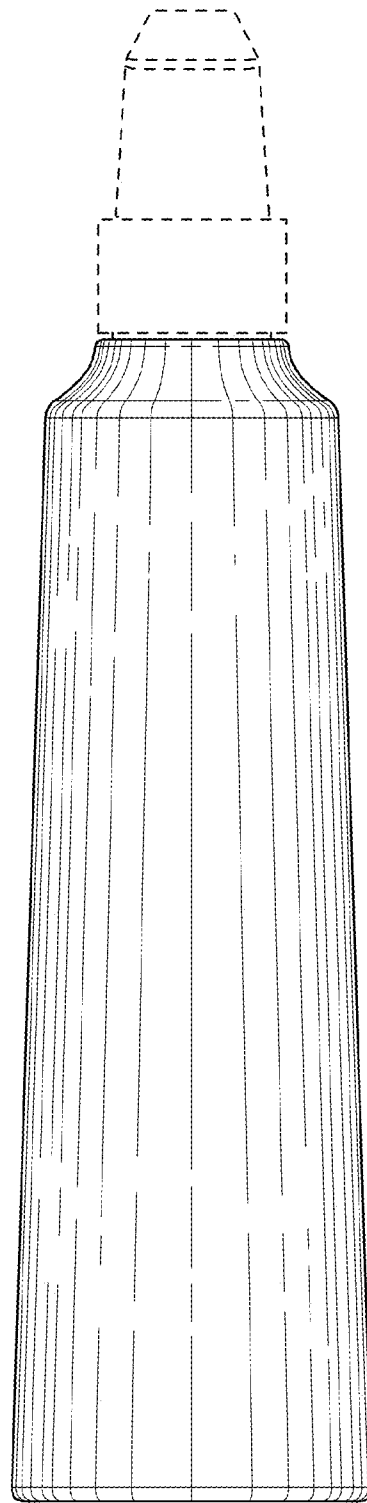

FIG. 11

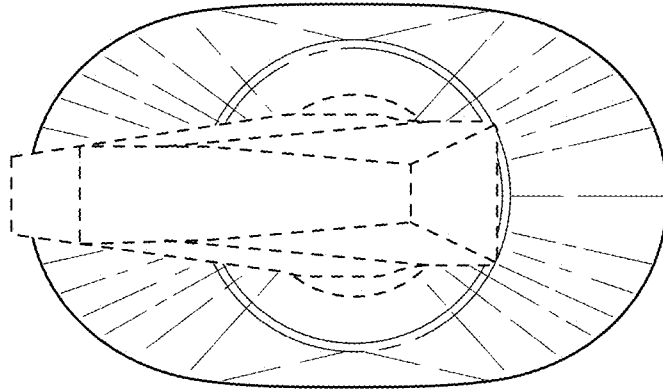

FIG. 12

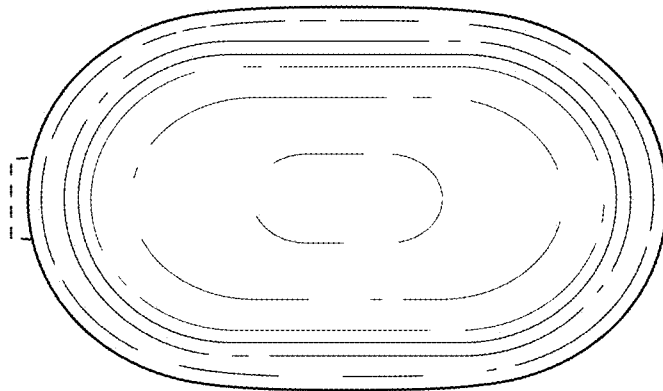

FIG. 13

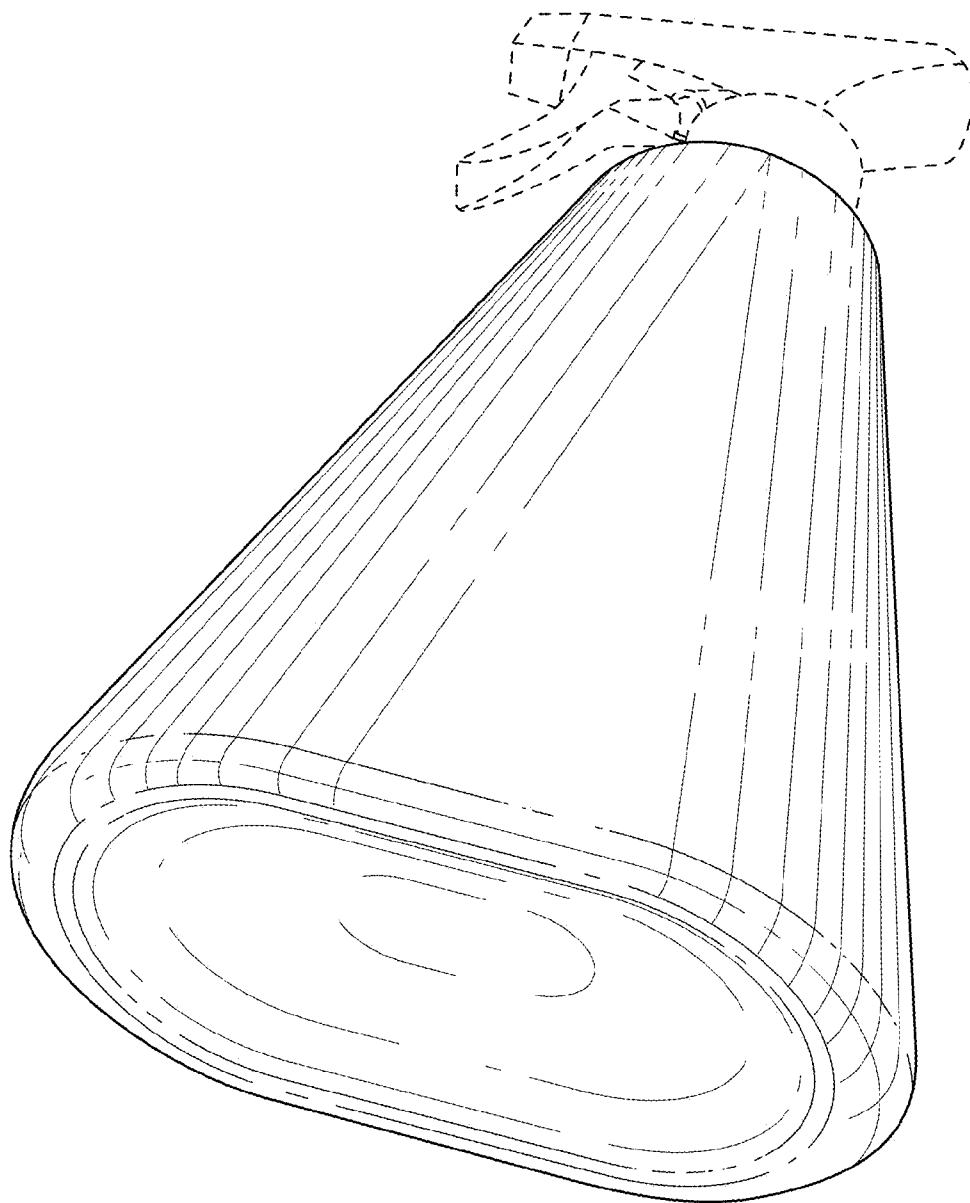

FIG. 14