



US00D484391S

(12) **United States Design Patent** (10) **Patent No.:** **US D484,391 S**
Hackbarth et al. (45) **Date of Patent:** **** Dec. 30, 2003**

(54) **LOCK BUMPERS**

(57) **CLAIM**

(75) Inventors: **Laura Hackbarth**, Waukesha, WI (US); **Michael Enslow**, Milwaukee, WI (US)

The ornamental design for lock bumpers, as shown and described.

(73) Assignee: **Master Lock Company**, Oak Creek, WI (US)

DESCRIPTION

(**) Term: **14 Years**

FIG. 1 is a perspective view of the design of the present invention;

(21) Appl. No.: **29/177,323**

FIG. 2 is a front view of the lock bumpers shown in FIG. 1; FIG. 3 is a right side view of the lock bumpers shown in FIG. 1;

(22) Filed: **Mar. 7, 2003**

FIG. 4 is a back view of the lock bumpers shown in FIG. 1; FIG. 5 is a left side view of the lock bumpers shown in FIG. 1;

(51) **LOC (7) Cl.** **08-07**

FIG. 6 is a top view of the lock bumpers shown in FIG. 1; FIG. 7 is a bottom view of the lock bumpers shown in FIG. 1;

(52) **U.S. Cl.** **D8/346; D8/334**

FIG. 8 is a perspective view of a second embodiment of the design of the present invention;

(58) **Field of Search** D8/330, 331, 334, D8/343, 346; 70/20, 14, 431, 443, 437, 51-54, 55; D12/167

FIG. 9 is a front view of the lock bumpers shown in FIG. 8; FIG. 10 is a right side view of the lock bumpers shown in FIG. 8;

(56) **References Cited**

U.S. PATENT DOCUMENTS

3,453,758 A	*	7/1969	Soref et al.	70/54
4,224,813 A	*	9/1980	Hampton	70/51
4,226,100 A	*	10/1980	Hampton et al.	70/53
4,317,344 A	*	3/1982	Bernard	70/55
D292,869 S	*	11/1987	Lebrecht	D8/346
D325,158 S	*	4/1992	Lebrecht	D8/346
D341,766 S		11/1993	Zacher	
D342,009 S		12/1993	Lebrecht et al.	
D342,010 S		12/1993	Lebrecht	
D395,224 S		6/1998	Turner	
D400,078 S		10/1998	Adelmeyer	
D406,044 S		2/1999	Turner	
D408,262 S		4/1999	Liu	
D423,324 S		4/2000	Liu	
D423,908 S		5/2000	Liu	
D432,391 S		10/2000	Heppner	
D455,639 S		4/2002	McDaid et al.	
D472,790 S		4/2003	Lai	
6,539,754 B1	*	4/2003	Fand	70/51

FIG. 11 is a back view of the lock bumpers shown in FIG. 8;

FIG. 12 is a left side view of the lock bumpers shown in FIG. 8;

FIG. 13 is a top view of the lock bumpers shown in FIG. 8; FIG. 14 is a bottom view of the lock bumpers shown in FIG. 8;

FIG. 15 is a perspective view of a third embodiment of the design of the present invention;

FIG. 16 is a front view of the lock bumpers shown in FIG. 15;

FIG. 17 is a right side view of the lock bumpers shown in FIG. 15;

FIG. 18 is a back view of the lock bumpers shown in FIG. 15;

FIG. 19 is a left side view of the lock bumpers shown in FIG. 15;

FIG. 20 is a top view of the lock bumpers shown in FIG. 15; and,

FIG. 21 is a bottom view of the lock bumpers shown in FIG. 15.

The portions of the Figures shown in phantom lines are not part of the claimed design but are for illustration only.

* cited by examiner

Primary Examiner—Prabhakar Deshmukh
(74) *Attorney, Agent, or Firm*—Calfee, Halter & Griswold LLP

1 Claim, 9 Drawing Sheets

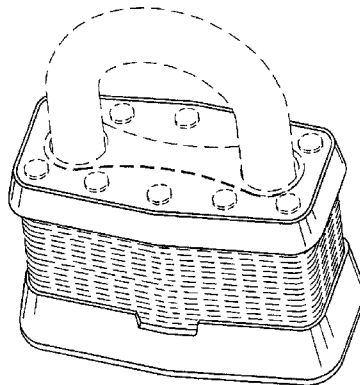

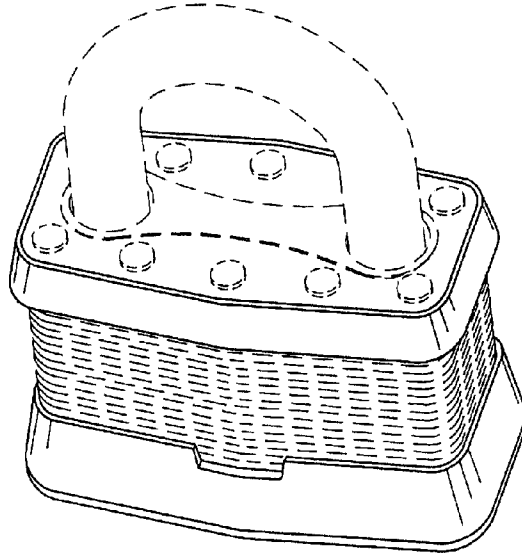

FIG. 1

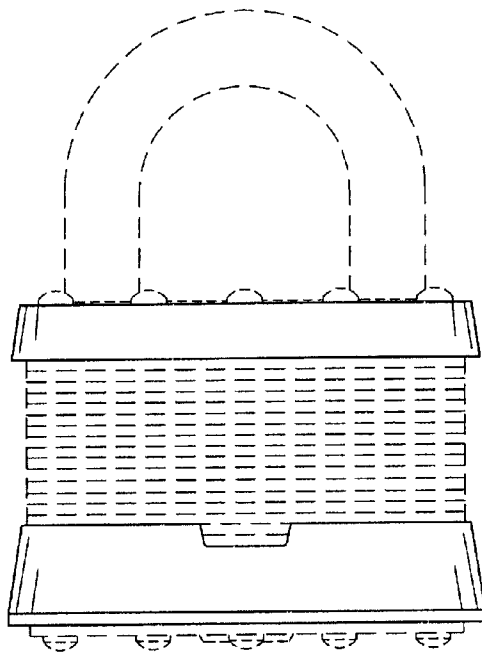

FIG. 2

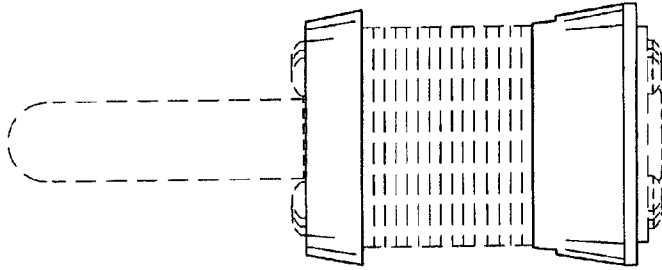

FIG. 3

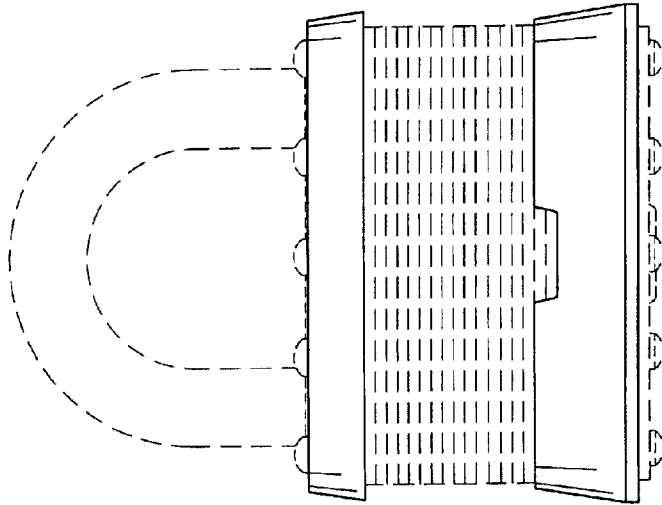

FIG. 4

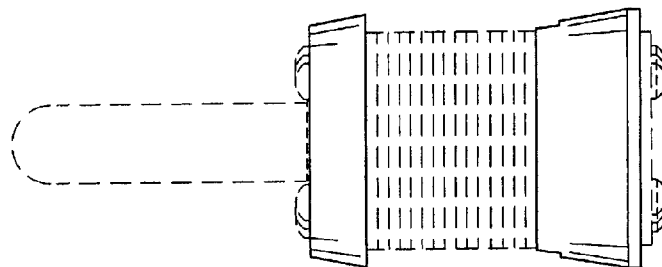

FIG. 5

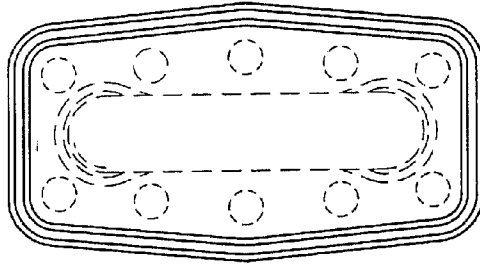

FIG. 6

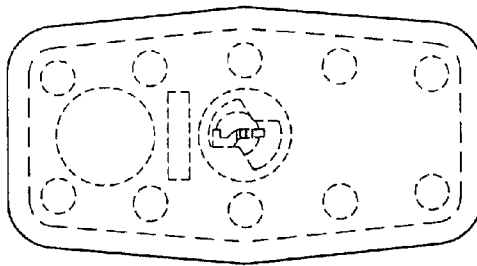

FIG. 7

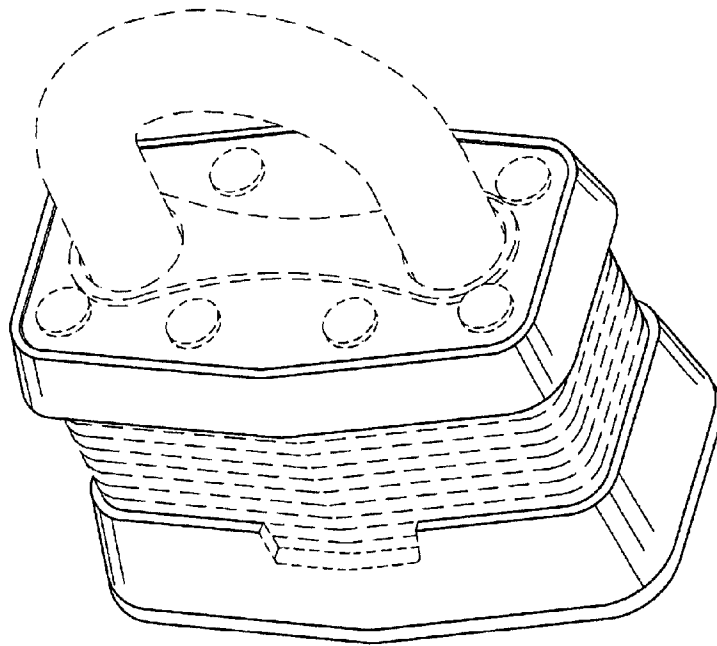
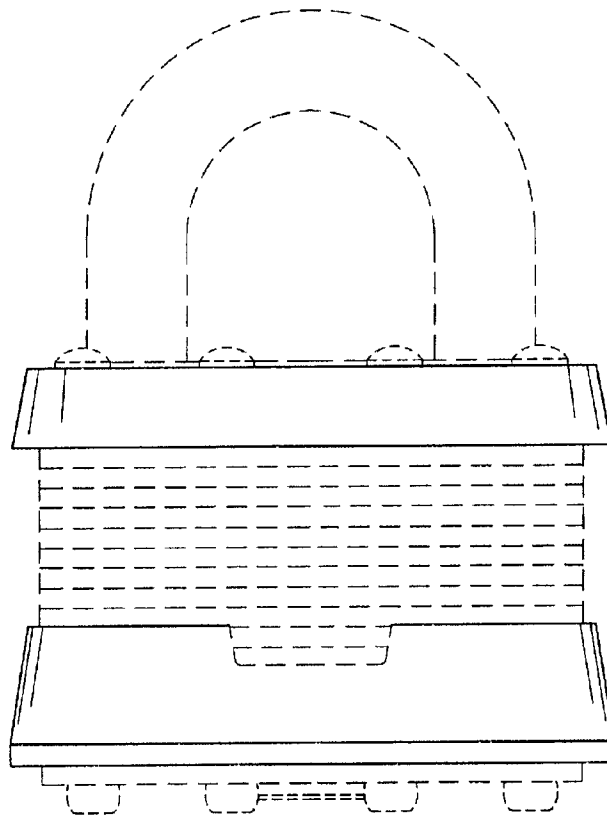

Fig. 8

Fig. 9



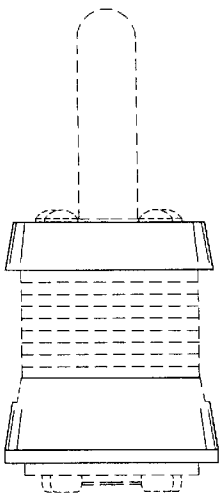

Fig. 10

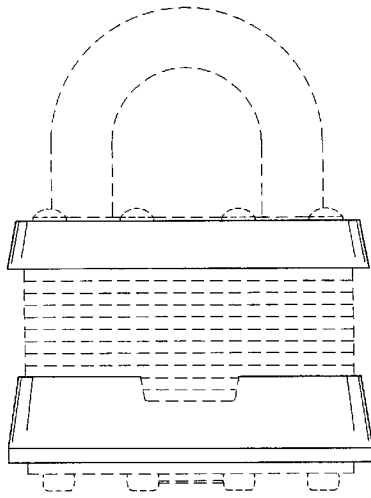

Fig. 11

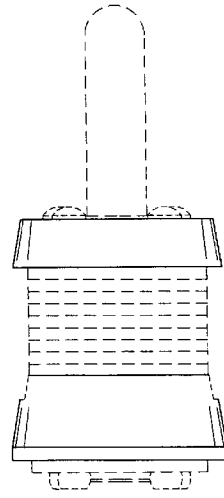

Fig. 12

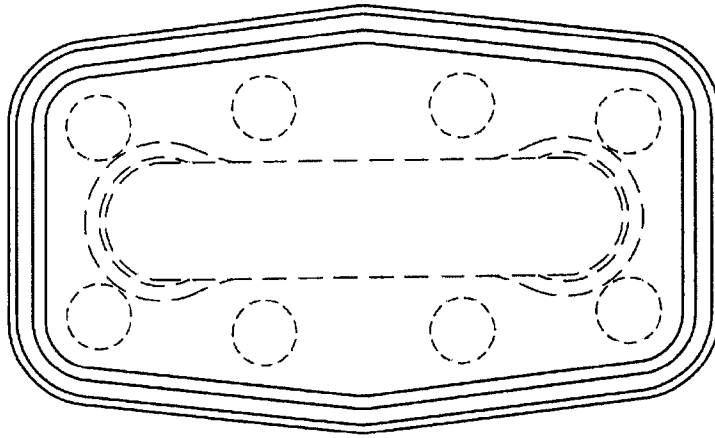

Fig. 13

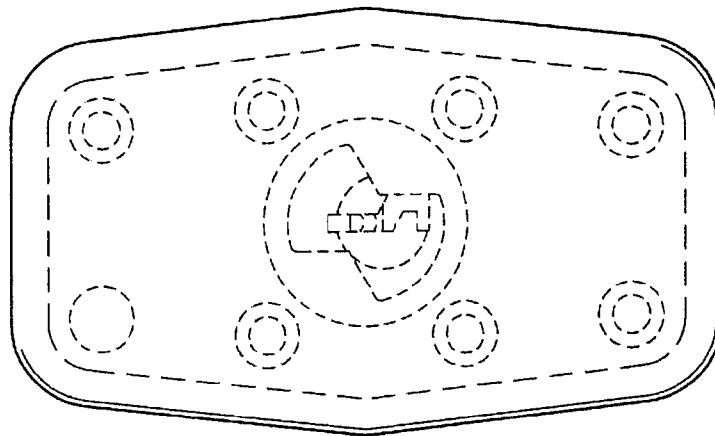

Fig.14

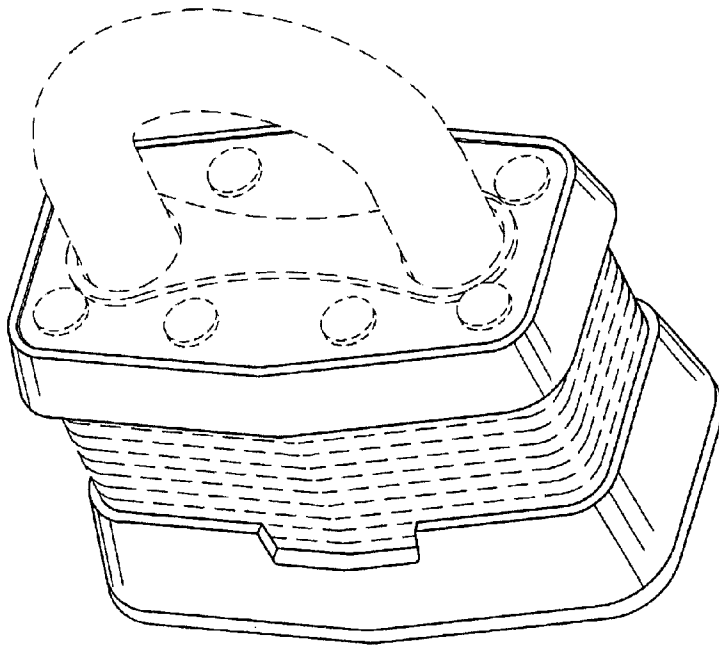

Fig. 15

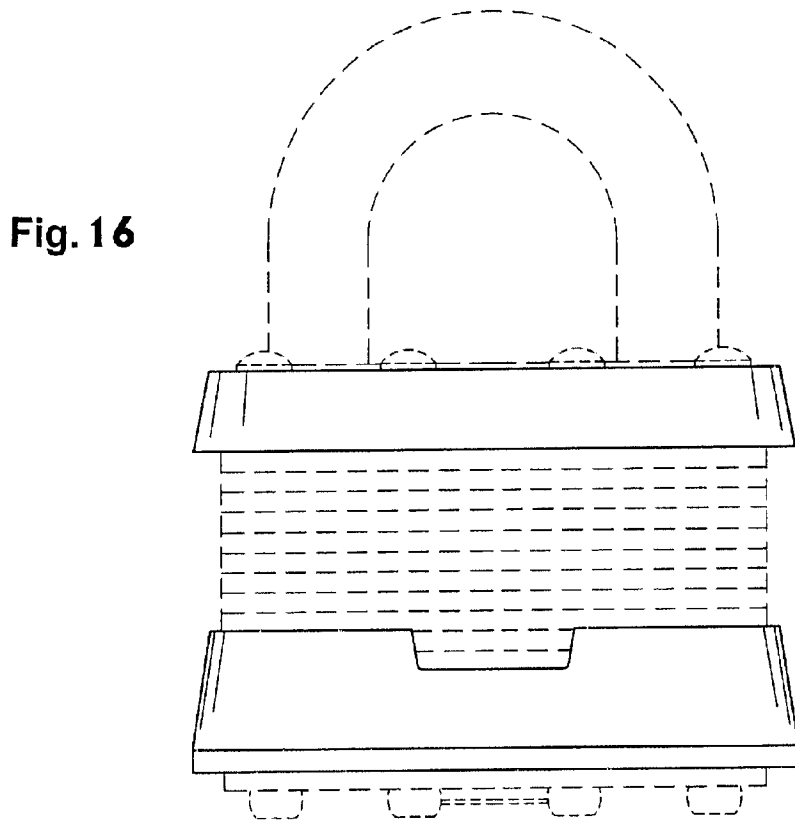

Fig. 16

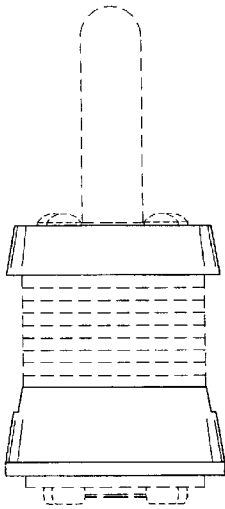

Fig. 17

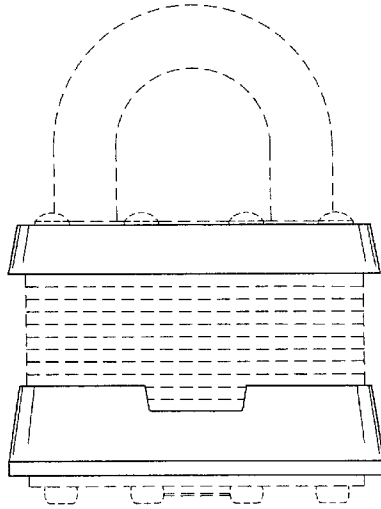

Fig. 18

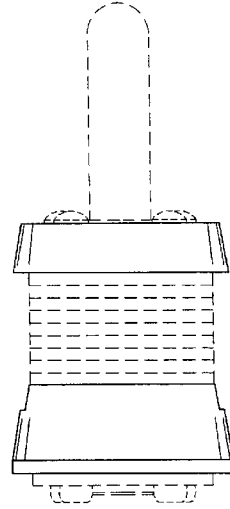

Fig. 19

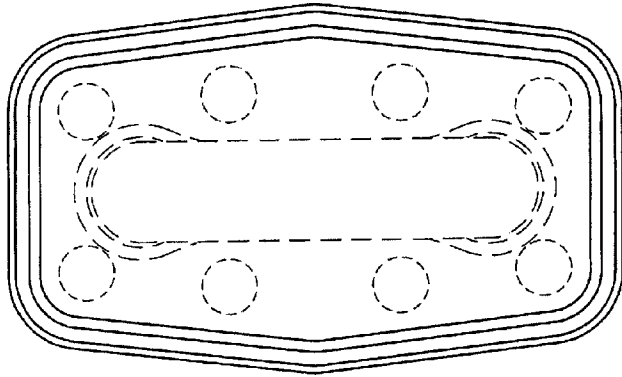

Fig. 20

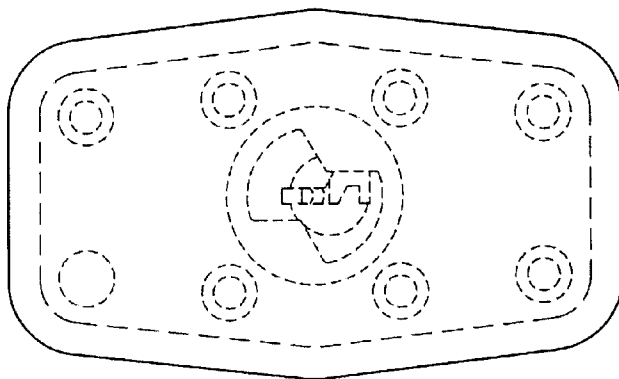

Fig. 21