



US00D835942S

(12) **United States Design Patent**  
**Koller et al.**

(10) **Patent No.:** **US D835,942 S**  
(45) **Date of Patent:** **\*\* Dec. 18, 2018**

(54) **TRAY WITH CUP HOLDER AND DEPOSIT AREA FOR STROLLER**

(71) Applicant: **CYBEX GMBH**, Bayreuth (DE)

(72) Inventors: **Peter Koller**, Bayreuth (DE); **Johannes Häuser**, Bayreuth (DE)

(\*\*) Term: **15 Years**

(21) Appl. No.: **35/503,092**

(22) Filed: **Dec. 2, 2016**

(80) **Hague Agreement Data**

Int. Filing Date: **Dec. 2, 2016**  
Int. Reg. No.: **DM/094794**  
Int. Reg. Date: **Dec. 2, 2016**  
Int. Reg. Pub. Date: **Jun. 2, 2017**

(51) **LOC (11) Cl.** ..... **07-01**

(52) **U.S. Cl.**  
USPC ..... **D7/552.1; D12/133**

(58) **Field of Classification Search**  
USPC ..... D7/396.1, 550.1, 552.1, 553.1, 553.2, D7/553.3, 553.4-553.5, 553.8, D7/554.1-554.2, 555; D6/406, 419, 500, D6/511; D12/129, 133; D34/12-27  
CPC .... B62B 9/26; B60R 7/00; A47C 7/70; A47D 15/00  
See application file for complete search history.

(56) **References Cited**

**U.S. PATENT DOCUMENTS**

D312,171 S *	11/1990	Roth	.....	D12/420
D318,176 S *	7/1991	Forrestal	.....	D12/420
D338,374 S *	8/1993	Jacobson	.....	D7/507
D351,738 S *	10/1994	LaCombe	.....	D12/416
D357,440 S *	4/1995	Pietra	.....	D12/133
D363,643 S *	10/1995	Eisenberg	.....	D7/546
D369,521 S *	5/1996	Wittenborn	.....	D3/215
D376,297 S *	12/1996	Jacobson	.....	D7/549

D393,981 S *	5/1998	Lipkowitz	.....	D7/552.1
D405,621 S *	2/1999	Myers	.....	D6/406.2
D423,290 S *	4/2000	Green	.....	D6/406.1
D435,196 S *	12/2000	Gregor	.....	D12/420
D496,828 S *	10/2004	Lackey	.....	D7/553.5
6,932,426 B2 *	8/2005	Greger	.....	A47D 1/008 297/149
D521,422 S *	5/2006	Williams	.....	D12/133
D527,953 S *	9/2006	Le Gal	.....	D7/552.1
D551,598 S *	9/2007	Yoshie	.....	D12/133
7,621,431 B2 *	11/2009	Williams	.....	B62B 9/26 224/282
8,262,124 B2 *	9/2012	Longenecker	.....	B62B 9/26 280/642
D714,011 S *	9/2014	Fredendall	.....	D34/27
D714,012 S *	9/2014	Fredendall	.....	D34/27
D730,124 S *	5/2015	Tollen	.....	D7/552.1
D733,388 S *	6/2015	Stauff	.....	D34/27
D749,993 S *	2/2016	Lee	.....	D12/133

\* cited by examiner

*Primary Examiner* — Darlington Ly

(57) **CLAIM**

The ornamental design for a tray with cup holder and deposit area for stroller, as shown and described.

**DESCRIPTION**

1. Tray with cup holder and deposit area for stroller  
**1.1** is a top, rear, and left side perspective view of a tray with cup holder and deposit area for stroller showing our new design;  
**1.2** is a left side elevation view thereof;  
**1.3** is a right side elevation view thereof;  
**1.4** is a top plan view thereof;  
**1.5** is a bottom plan view thereof;  
**1.6** is a front elevation view thereof; and  
**1.7** is a rear elevation view thereof.  
The broken lines and the area within the broken lines in the drawings depict portions of the tray with cup holder and deposit area for stroller that form no part of the claim.

**1 Claim, 7 Drawing Sheets**

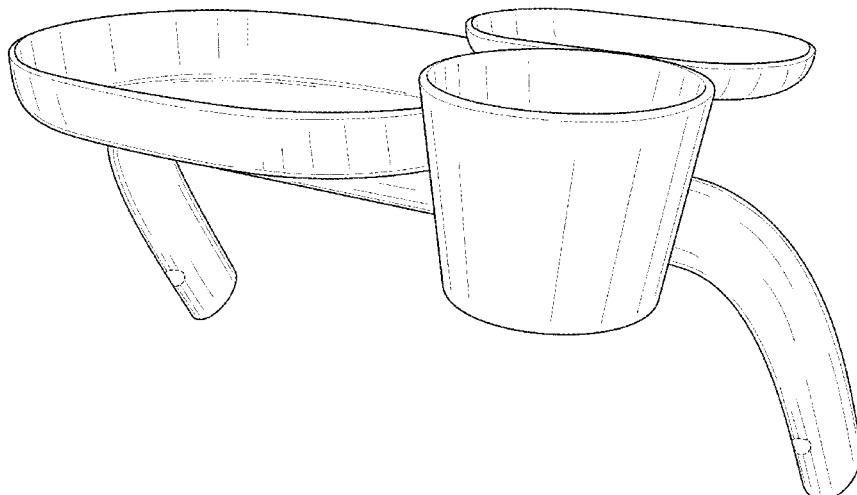

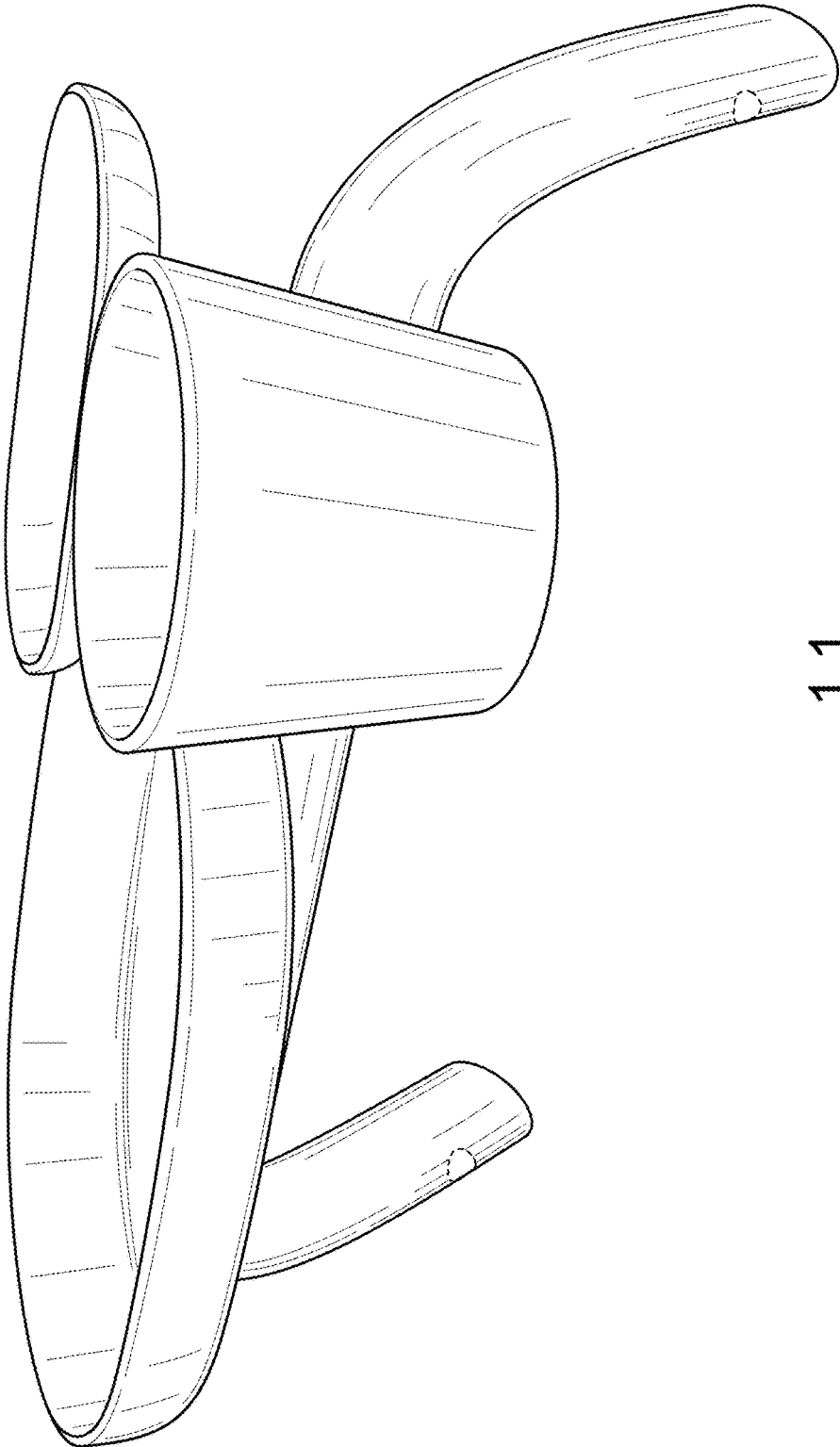

1.1

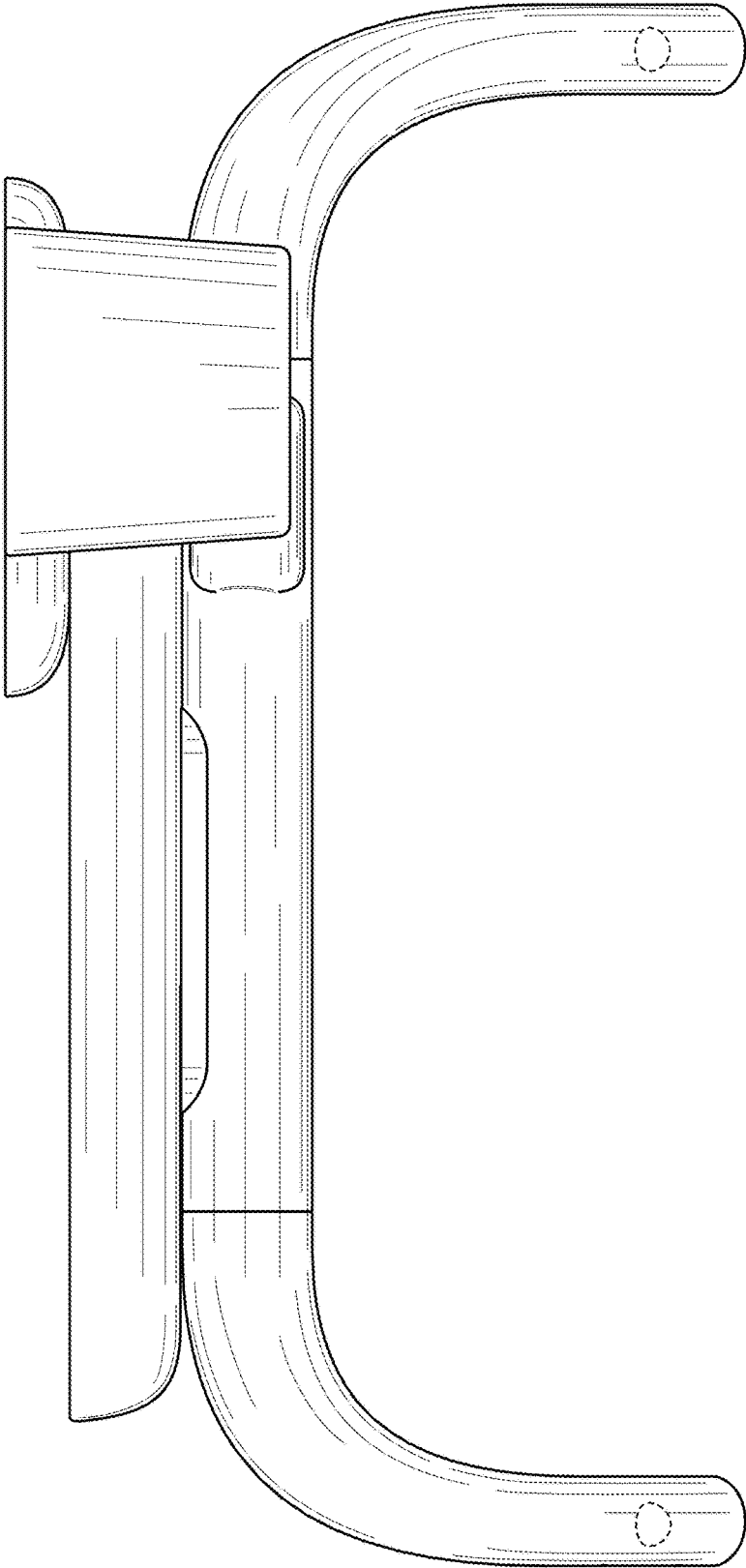

1.2

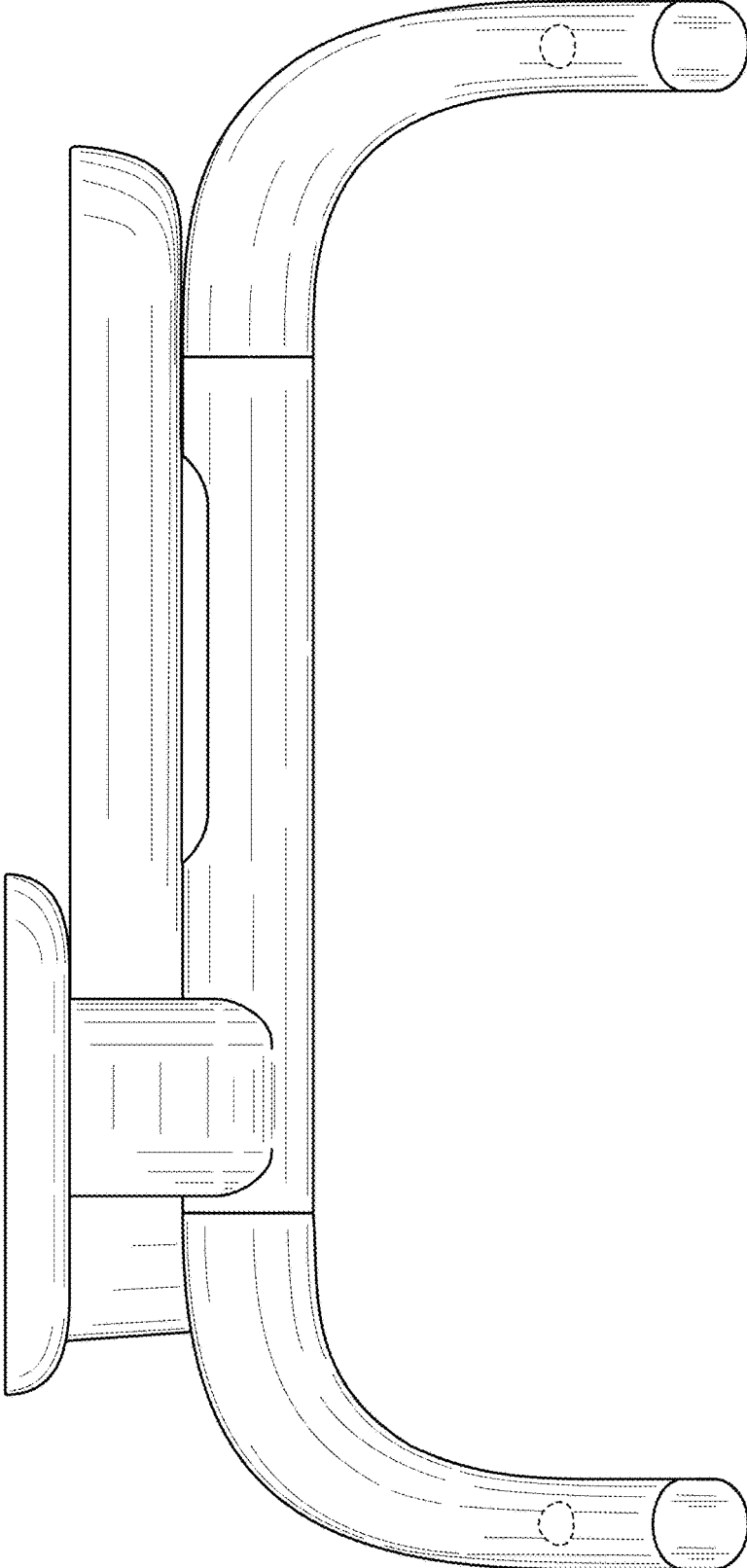

1.3

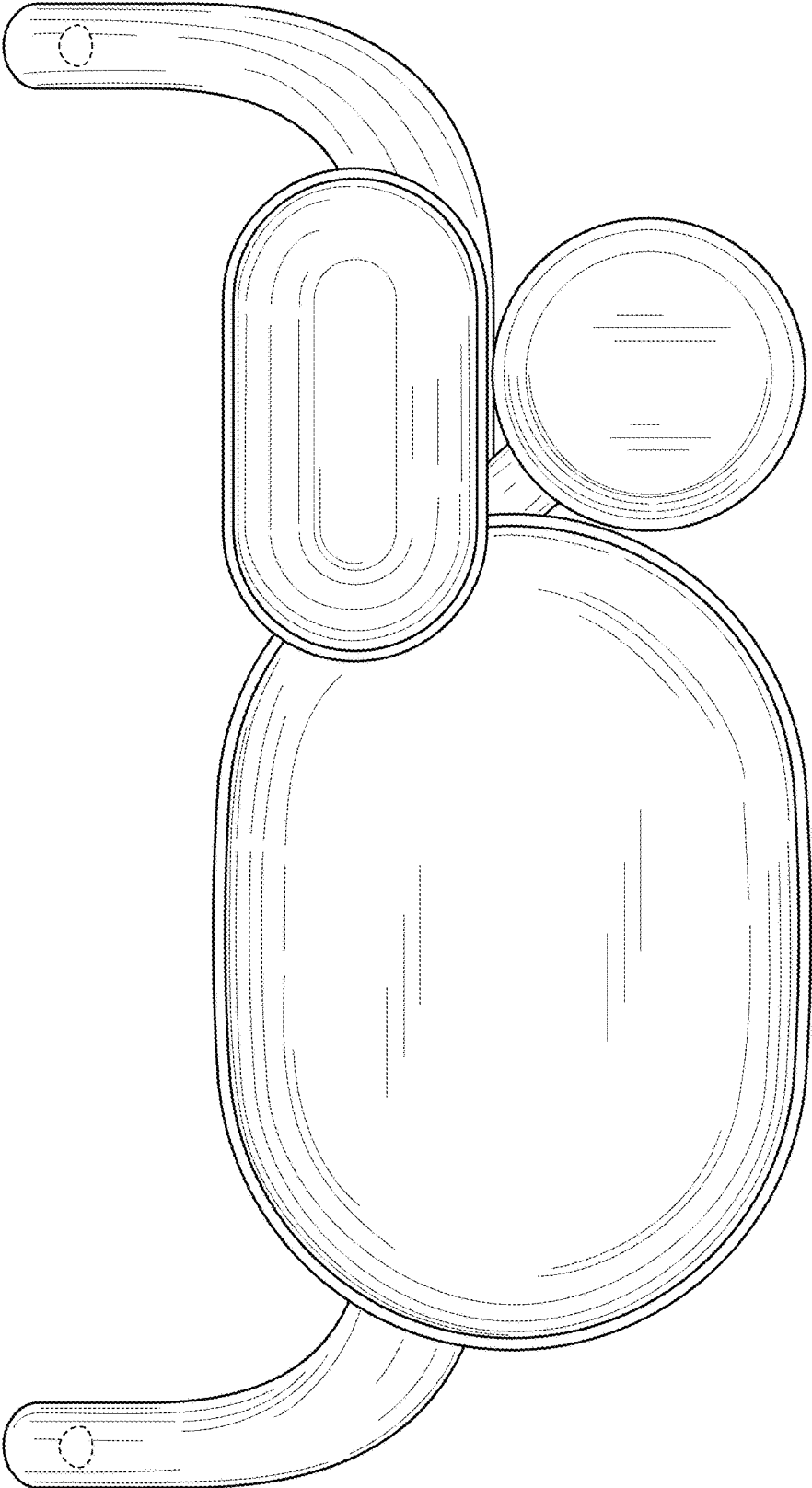

1.4

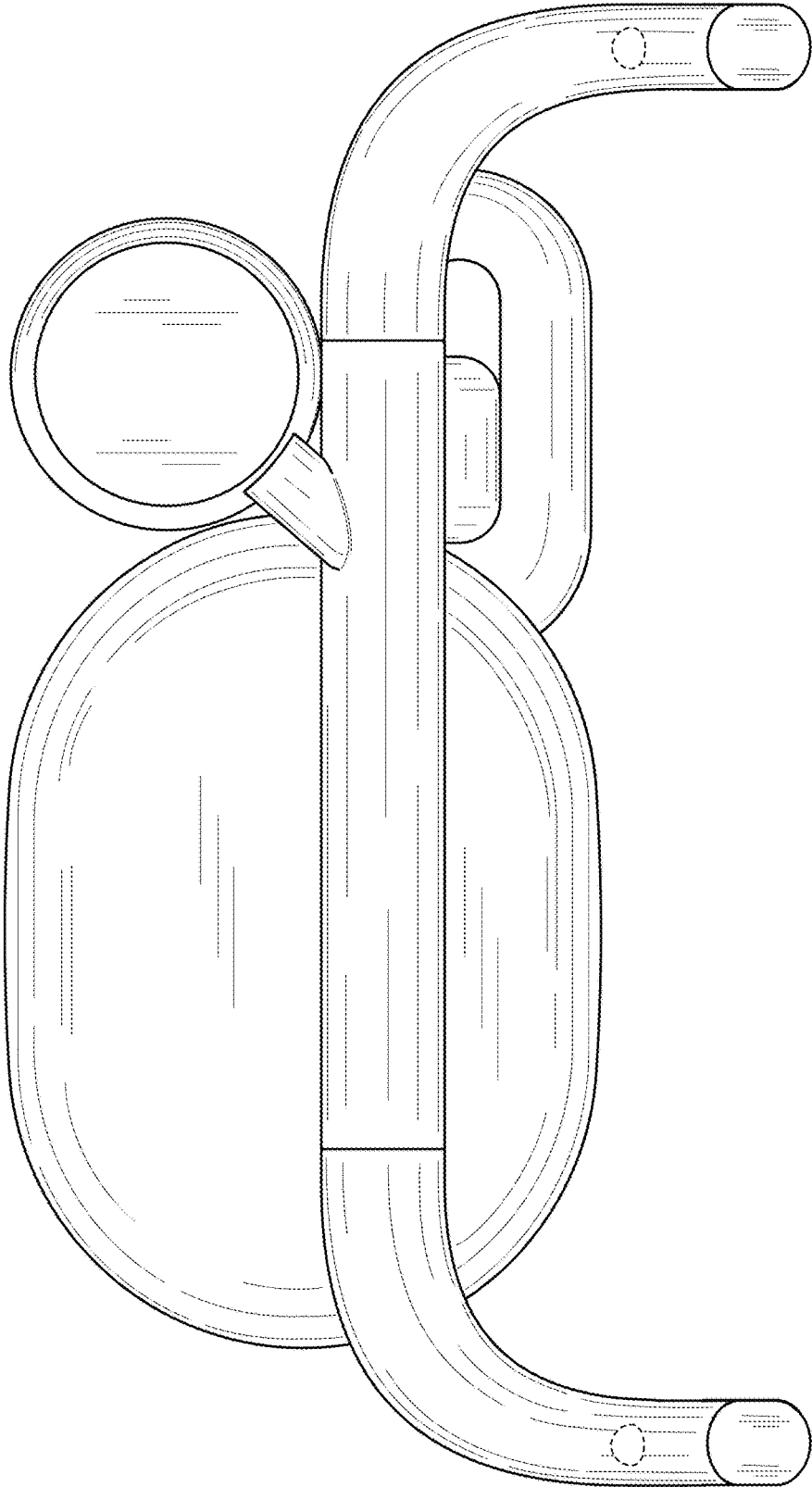

1.5

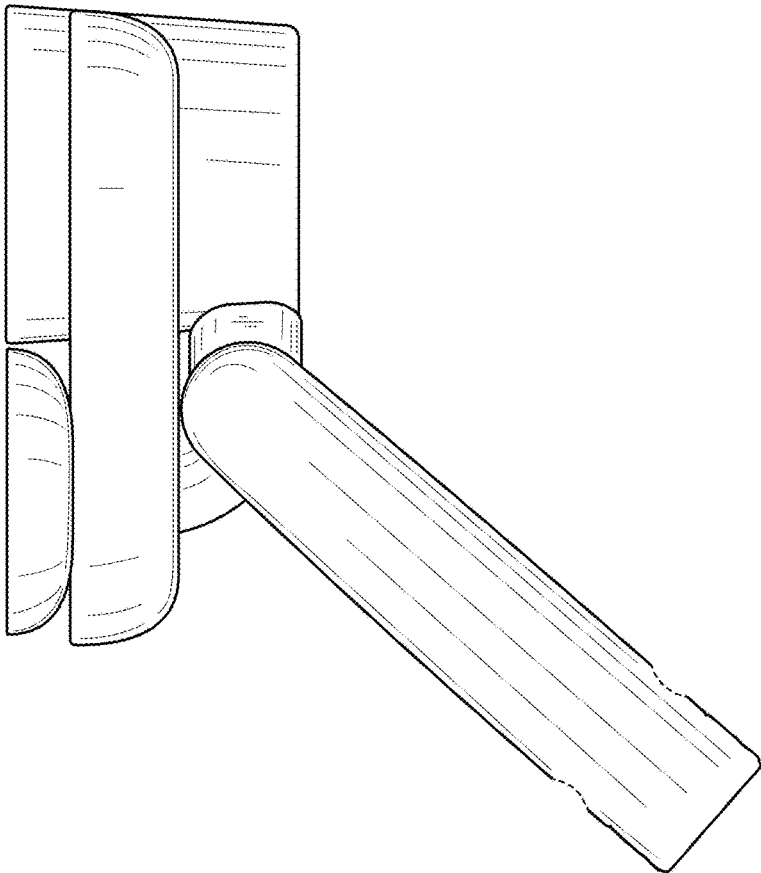

1.6

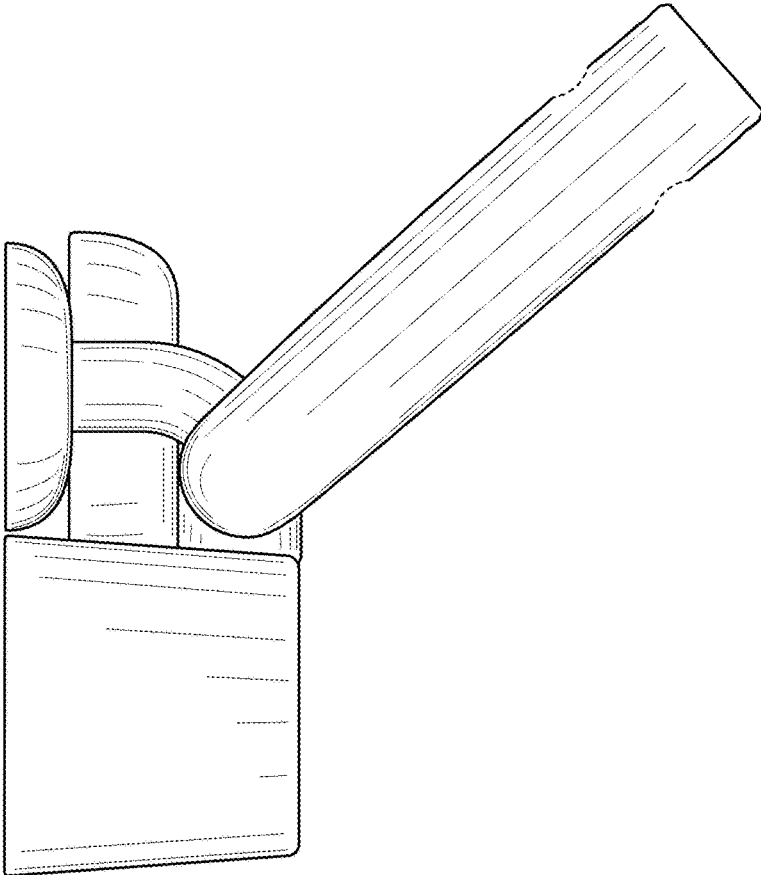

1.7