



(86) Date de dépôt PCT/PCT Filing Date: 2003/09/04  
 (87) Date publication PCT/PCT Publication Date: 2004/03/18  
 (45) Date de délivrance/Issue Date: 2014/08/05  
 (85) Entrée phase nationale/National Entry: 2005/03/04  
 (86) N° demande PCT/PCT Application No.: US 2003/027588  
 (87) N° publication PCT/PCT Publication No.: 2004/022099  
 (30) Priorités/Priorities: 2002/09/06 (US60/408,855);  
 2002/10/31 (US60/422,830); 2003/03/04 (US60/451,998)

(51) Cl.Int./Int.Cl. *A61K 47/48* (2006.01),  
*C08B 37/16* (2006.01)  
 (72) Inventeurs/Inventors:  
 CHENG, JIANJUN, US;  
 DAVIS, MARK E., US;  
 KHIN, KAY T., US  
 (73) Propriétaire/Owner:  
 CERULEAN PHARMA INC., US  
 (74) Agent: BORDEN LADNER GERVAIS LLP

(54) Titre : POLYMERES A BASE DE CYCLODEXTRINE POUR ADMINISTRATION DE MEDICAMENTS  
 (54) Title: CYCLODEXTRIN-BASED POLYMERS FOR THERAPEUTICS DELIVERY

(57) **Abrégé/Abstract:**

The present invention relates to novel compositions of therapeutic cyclodextrin containing polymeric compounds designed as a carrier for small molecule therapeutics delivery and pharmaceutical compositions thereof. In particular, the therapeutic/bioactive agents are covalently bound to the cyclodextrin-containing polymers. These cyclodextrin-containing polymers improve drug stability and solubility, and reduce toxicity of the small molecule therapeutic when used in vivo. Furthermore, by selecting from a variety of linker groups and targeting ligands the polymers present methods for controlled delivery of the therapeutic agents. The invention also relates to methods of treating subjects with the therapeutic compositions described herein. The invention further relates to methods for conducting pharmaceutical business comprising manufacturing, licensing, or distribution kits containing or relating to the polymeric compounds described herein.



## (12) INTERNATIONAL APPLICATION PUBLISHED UNDER THE PATENT COOPERATION TREATY (PCT)

(19) World Intellectual Property  
Organization  
International Bureau



(43) International Publication Date  
18 March 2004 (18.03.2004)

PCT

(10) International Publication Number  
**WO 2004/022099 A3**

- (51) International Patent Classification<sup>7</sup>: **A61K 47/48**, 47/40, A61P 35/00
- (74) Agents: HALSTEAD, David, P. et al.; Ropes & Gray LLP, One International Place, Boston, MA 02110-2624 (US).
- (21) International Application Number: PCT/US2003/027588
- (81) Designated States (*national*): AE, AG, AL, AM, AT, AU, AZ, BA, BB, BG, BR, BY, BZ, CA, CH, CN, CO, CR, CU, CZ, DE, DK, DM, DZ, EC, EE, ES, FI, GB, GD, GE, GH, GM, HR, HU, ID, IL, IN, IS, JP, KE, KG, KP, KR, KZ, LC, LK, LR, LS, LT, LU, LV, MA, MD, MG, MK, MN, MW, MX, MZ, NI, NO, NZ, OM, PG, PH, PL, PT, RO, RU, SC, SD, SE, SG, SK, SL, SY, TJ, TM, TN, TR, TT, TZ, UA, UG, US, UZ, VC, VN, YU, ZA, ZM, ZW.
- (22) International Filing Date: 4 September 2003 (04.09.2003)
- (84) Designated States (*regional*): ARIPO patent (GH, GM, KE, LS, MW, MZ, SD, SL, SZ, TZ, UG, ZM, ZW), Eurasian patent (AM, AZ, BY, KG, KZ, MD, RU, TJ, TM), European patent (AT, BE, BG, CH, CY, CZ, DE, DK, EE, ES, FI, FR, GB, GR, HU, IE, IT, LU, MC, NL, PT, RO, SE, SI, SK, TR), OAPI patent (BF, BJ, CF, CG, CI, CM, GA, GN, GQ, GW, ML, MR, NE, SN, TD, TG).
- (25) Filing Language: English
- (30) Priority Data:
- |            |                               |    |
|------------|-------------------------------|----|
| 60/408,855 | 6 September 2002 (06.09.2002) | US |
| 60/422,830 | 31 October 2002 (31.10.2002)  | US |
| 60/451,998 | 4 March 2003 (04.03.2003)     | US |
- (71) Applicant (*for all designated States except US*): INSERT THERAPEUTICS, INC. [US/US]; 2585 Nina Street, Pasadena, CA 91107 (US).
- (72) Inventors; and
- (75) Inventors/Applicants (*for US only*): CHENG, Jianjun [CN/US]; 1009 Fairview Avenue, Apt. H, Arcadia, CA 91007 (US). DAVIS, Mark, E. [US/US]; 575 Laguna Road, Pasadena, CA 91105 (US). KHIN, Kay, T. [US/US]; 419 East Broadway Avenue, Apartment #C, San Gabriel, CA 91776 (US).
- Published:**
- with international search report
  - before the expiration of the time limit for amending the claims and to be republished in the event of receipt of amendments
- (88) Date of publication of the international search report: 28 October 2004
- For two-letter codes and other abbreviations, refer to the "Guidance Notes on Codes and Abbreviations" appearing at the beginning of each regular issue of the PCT Gazette.*

(54) Title: CYCLODEXTRIN-BASED POLYMERS FOR DELIVERING THE THERAPEUTIC AGENTS COVALENTLY BOUND THERETO

(57) Abstract: The present invention relates to novel compositions of therapeutic cyclodextrin containing polymeric compounds designed as a carrier for small molecule therapeutics delivery and pharmaceutical compositions thereof. In particular, the therapeutic/bioactive agents are covalently bound to the cyclodextrin-containing polymers. These cyclodextrin-containing polymers improve drug stability and solubility, and reduce toxicity of the small molecule therapeutic when used in vivo. Furthermore, by selecting from a variety of linker groups and targeting ligands the polymers present methods for controlled delivery of the therapeutic agents. The invention also relates to methods of treating subjects with the therapeutic compositions described herein. The invention further relates to methods for conducting pharmaceutical business comprising manufacturing, licensing, or distribution kits containing or relating to the polymeric compounds described herein.



WO 2004/022099 A3



## Cyclodextrin-Based Polymers for Therapeutics Delivery

### Background of the Invention

Drug delivery of some small molecule therapeutic agents, such as  
5 camptothecin, has been problematic due to their poor pharmacological profiles. These therapeutic agents often have low aqueous solubility, their bioactive forms exist in equilibrium with an inactive form, or high systemic concentrations of the agents lead to toxic side-effects. Some approaches to circumvent the problem of their delivery have been to conjugate the agent directly to a water-soluble polymer  
10 such as hydroxypropyl methacrylate (HPMA), polyethyleneglycol, and poly-L-glutamic acid. In some cases, such conjugates have been successful in solubilizing or stabilizing the bioactive form of the therapeutic agent, or achieving a sustained release formulation which circumvents complications associated with high systemic concentrations of the agent.

15 Another approach to the drug delivery problem has been to form host/guest inclusion complexes between the therapeutic agent and cyclodextrins or derivatives thereof. Cyclodextrins ( $\alpha$ ,  $\beta$ ,  $\gamma$ ) and their oxidized forms have unique physico-chemical properties such as good water solubility, low toxicity and low immune response. To date, most of the drug delivery studies with cyclodextrins have  
20 focused on their ability to form supra-molecular complexes, wherein cyclodextrins form host/guest inclusion complexes with therapeutic molecules and thus alter the physical, chemical, and/or biological properties of these guest molecules.

U.S. Patent 5,276,088 describes a method for synthesizing cyclodextrin-containing polymers by either reacting polyvinyl alcohol or cellulose or derivatives  
25 thereof with cyclodextrin derivatives, or by copolymerization of a cyclodextrin derivative with vinyl acetate or methyl methacrylate.

U.S. Patent No. 5,855,900 describes a biodegradable cyclodextrin-containing polymer. The patent discloses a supramolecular-structured biodegradable polymeric assembly comprising a plurality of drug-modified  $\alpha$ ,  $\beta$ ,  $\gamma$ -cyclodextrins

and a linear polymeric chain threading through the structural cavity of the cyclodextrins.

There is an ongoing need for new approaches to the delivery of small therapeutic agents that have poor pharmacological profiles such as camptothecin,  
5 paclitaxel, doxorubicin, and cyclosporine A.

### Summary of the Invention

The present invention relates to novel compositions of polymer conjugates, defined as polymeric materials covalently coupled to therapeutic/bioactive agents, as  
10 carriers for therapeutics delivery. In one aspect, the present invention provides water-soluble, biocompatible polymer conjugates comprising a water-soluble, biocompatible polymer covalently attached to bioactive moieties through attachments that are cleaved under biological conditions to release the bioactive  
15 moieties. In certain such embodiments, the polymer comprises cyclic moieties alternating with linker moieties that connect the cyclic structures, e.g., into linear or branched polymers, preferably linear polymers. The polymer may be a polycation, polyanion, or non-ionic polymer. The bioactive agent, which may be a therapeutic agent, a diagnostic agent, or an adjuvant, preferably makes up at least 5%, 10%, 15%, 20%, 25%, 30%, or even 35% by weight of the conjugate. In certain  
20 embodiments, the rate of drug release is dependent primarily upon the rate of hydrolysis. In certain other embodiments, the rate of drug release is dependent primarily on enzymatic cleavage.

The present invention provides cyclodextrin-containing polymeric compounds for use in drug delivery of these therapeutic agents. The invention also  
25 provides compounds for use in controlled drug delivery which are capable of releasing a therapeutic agent in a targeted, predictable, and controlled rate.

Accordingly, one aspect of the present invention is a polymer conjugate comprising cyclodextrin moieties, a therapeutic agent, and an optional ligand targeting agent. The polymer may be linear or branched, and may be formed via



polycondensation of cyclodextrin-containing monomers, copolymerization between one or more cyclodextrin-containing monomers and one or more comonomers which do not contain cyclodextrin moieties. Furthermore, the present invention also contemplates cyclodextrin-containing polymers formed by grafting cyclodextrin moieties to an already formed polymer. The cyclodextrin moieties contemplated by the present invention include, but are not limited to,  $\alpha$ ,  $\beta$ , and  $\gamma$  cyclodextrins and oxidized forms thereof. Depending on the drug/polymer ratio desired, the therapeutic agent may be attached to a monomer via an optional linker prior to the polymerization step, or may be subsequently grafted onto the polymer via an optional linker. Likewise, the targeting ligand may be attached to a monomer via an optional linker prior the polymerization step, or may be subsequently grafted onto the polymer via an optional linker, or may be attached to the polymer as an inclusion complex or host-guest interactions.

To illustrate further, one embodiment of the invention is a polymeric compound represented by Formula I:

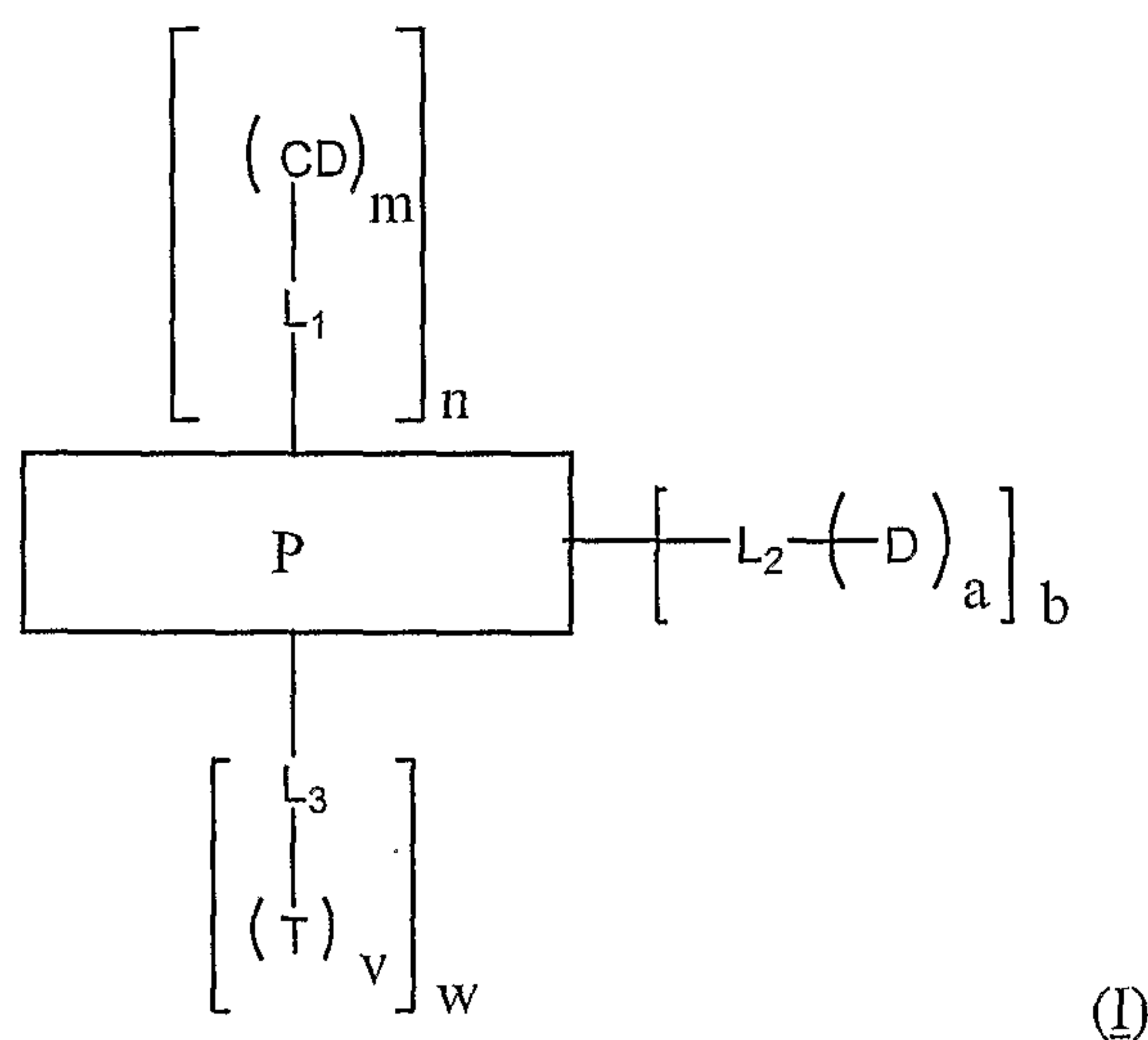

wherein

- 20            P represents a linear or branched polymer chain;  
               CD represents a cyclic moiety such as a cyclodextrin moiety;

$L_1$ ,  $L_2$  and  $L_3$ , independently for each occurrence, may be absent or represent a linker group;

$D$ , independently for each occurrence, represents a therapeutic agent or a prodrug thereof;

5  $T$ , independently for each occurrence, represents a targeting ligand or precursor thereof;

$a$ ,  $m$ , and  $v$ , independently for each occurrence, represent integers in the range of 1 to 10 (preferably 1 to 8, 1 to 5, or even 1 to 3);

10  $b$  represents an integer in the range of 1 to about 30,000 (preferably <25,000, <20,000, <15,000, <10,000, <5,000, <1,000, <500, <100, <50, <25, <10, or even <5); and

$n$  and  $w$ , independently for each occurrence, represents an integer in the range of 0 to about 30,000 (preferably <25,000, <20,000, <15,000, <10,000, <5,000, <1,000, <500, <100, <50, <25, <10, or even <5),

15 wherein either the polymer chain comprises cyclodextrin moieties or  $n$  is at least 1.

Another embodiment of the present invention is a compound represented by Formula II:

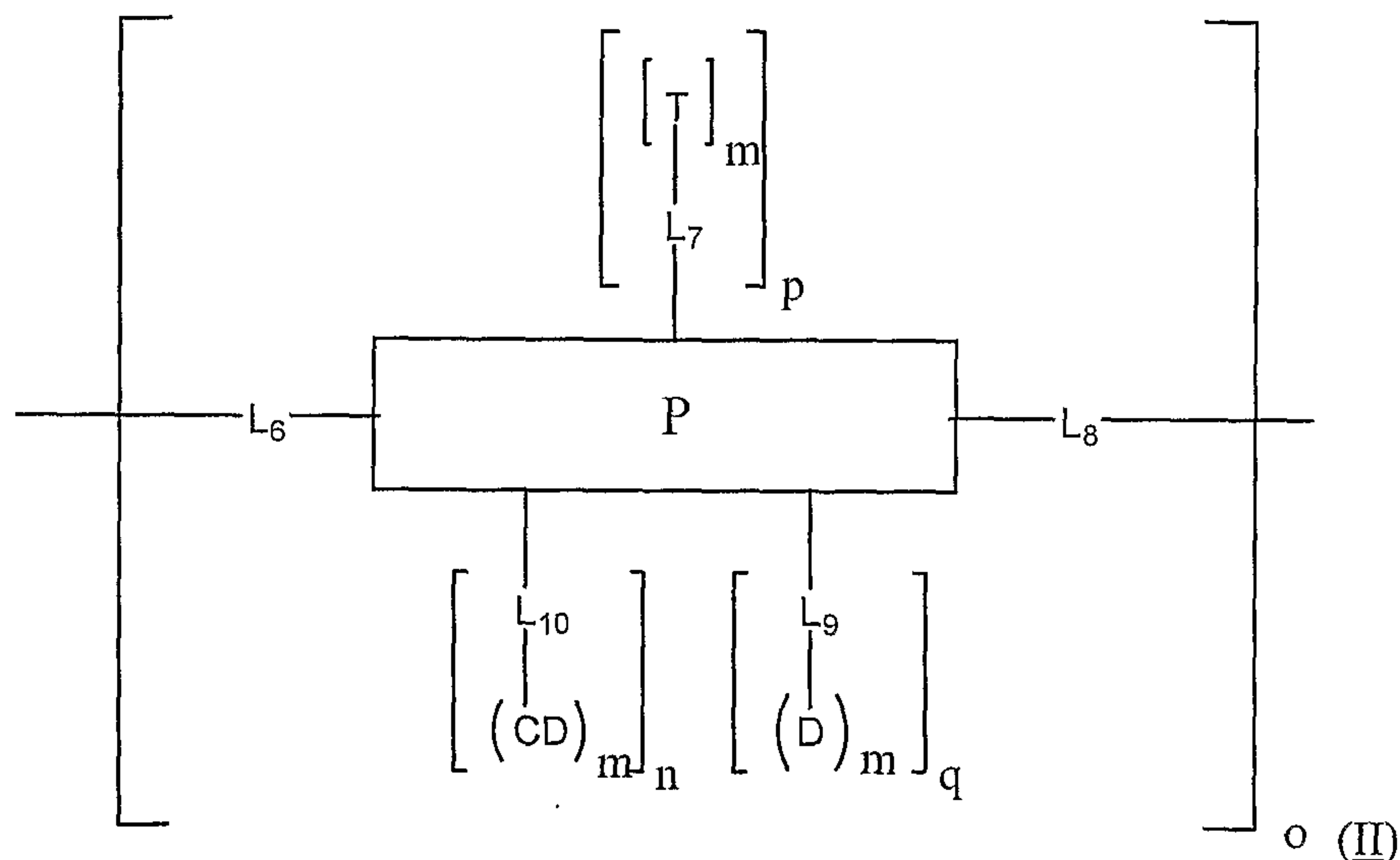

wherein

P represents a monomer unit of a polymer;

T, independently for each occurrence, represents a targeting ligand or a precursor thereof;

5 L<sub>6</sub>, L<sub>7</sub>, L<sub>8</sub>, L<sub>9</sub>, and L<sub>10</sub>, independently for each occurrence, may be absent or represent a linker group;

CD, independently for each occurrence, represents a cyclic moiety such as a cyclodextrin moiety or a derivative thereof;

D, independently for each occurrence, represents a therapeutic agent or a prodrug form thereof;

10 m, independently for each occurrence, represents an integer in the range of 1 to 10 (preferably 1 to 8, 1 to 5, or even 1 to 3);

o represents an integer in the range of 1 to about 30,000 (preferably <25,000, <20,000, <15,000, <10,000, <5,000, <1,000, <500, <100, <50, <25, <10, or even <5); and

15 p, n, and q, independently for each occurrence, represent an integer in the range of 0 to 10 (preferably 0 to 8, 0 to 5, 0 to 3, or even 0 to about 2),

wherein CD and D are preferably each present at at least 1 location (preferably at least 5, 10, 25, 50 or even >100 locations) in the compound.

20 Another embodiment of the present invention is a compound represented by Formula III:

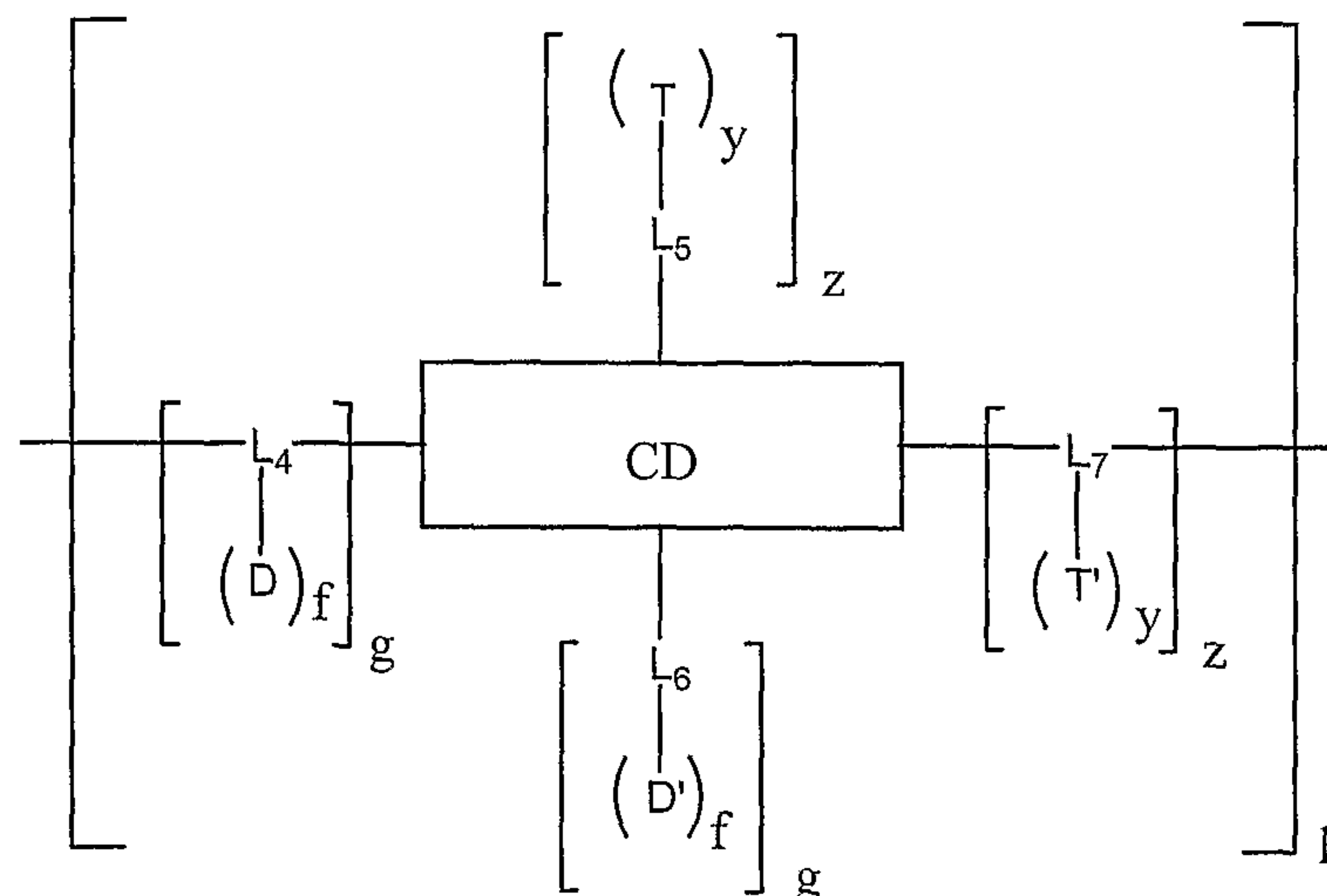



wherein

CD represents a cyclic moiety such as a cyclodextrin moiety, or derivative thereof;

5 L<sub>4</sub>, L<sub>5</sub>, L<sub>6</sub>, and L<sub>7</sub>, independently for each occurrence, may be absent or represent a linker group;

D and D', independently for each occurrence, represent the same or different therapeutic agent or prodrugs thereof;

T and T', independently for each occurrence, represent the same or different targeting ligand or precursor thereof;

10 f and y, independently for each occurrence, represent an integer in the range of 1 and 10 (preferably 1 to 8, 1 to 5, or even 1 to 3);

g and z, independently for each occurrence, represent an integer in the range of 0 and 10 (preferably 0 to 8, 0 to 5, 0 to 3, or even 0 to about 2); and

15 h represents an integer in the range of 1 and 30,000 (preferably <25,000, <20,000, <15,000, <10,000, <5,000, <1,000, <500, <100, <50, <25, <10, or even <5),

wherein at least one occurrence (and preferably at least 5, 10, or even at least 20, 50, or >100 occurrences) of g represents an integer greater than 0.

20 Another aspect of the present invention is a method for preparing the therapeutic cyclodextrin-containing polymeric conjugates described herein.

Another aspect of the present invention is a pharmaceutical composition comprising a compound or polymer as discussed above.

25 Another aspect of the present invention is a pharmaceutical dosage form comprising a polymeric conjugate as described herein.

Another aspect of the present invention is a method for treating a subject comprising administering a therapeutically effective amount of any of the polymeric conjugates described herein.



Another aspect of the present invention is a method of conducting a pharmaceutical business comprising manufacturing, licensing, or distributing kits containing or relating to any of the polymeric conjugates described herein.

In certain embodiments, these therapeutic polymer conjugates improve drug  
5 stability and/or solubility of the therapeutic agent when used in vivo. Furthermore, by selecting from a variety of linker groups, the polymer conjugates present methods for controlled release of the therapeutic and/or bioactive agents, or improve the in vivo safety and/or therapeutic efficacy of the therapeutic/bioactive agent. In certain embodiments, the polymer conjugates are bioerodable or biodegradable.

## 10 Brief Description of the Figures

Figure 1 shows strategies for varying polymer conjugates to tune their characteristics.

Figure 2 demonstrates the effect of peptide tether length on drug release rate for drug-loaded CD polymer.

15 Figure 3 presents the effect that tethering camptothecin has on enhancing camptothecin stability, e.g., inhibiting lactone ring-opening.

Figure 4 shows lactone ring opening studies in pH 7.4 KH<sub>2</sub>PO<sub>4</sub> buffer.

Figure 5a and 5b show polymerization control by adjusting polymerization time.

20 Figures 6 illustrates CPT release from **HG6** and **HGGG6** at 37 °C after 24 h in buffer solutions with pHs ranging from 1.1 to 13.1.

Figure 7 Displays HPLC analysis of degradation of CD-BisCys-SS-Peg3400 Polymer

Figure 8 Shows the tumor growth curve as a function of time for the D5W,  
25 CPT, irinotecan, **LGGG10** at its highest non-toxic dose tested (18 mg CPT/kg), and the other three conjugates with high MW polymer (**HGGG6**, **HG6**, **HGGG10**) at their MTDs in xenograft mice.

Figure 9 presents the median tumor growth curves for **HGGG6**, **HG6** and **HGGG10** in xenograft mice.

30 Figure 10 presents the medium tumor growth curves for **LGGG10** and **HGGG10** each dosed at 9 mg CPT/kg in xenograft mice.

Figure 11 presents the mean body weight (MBW) losses as a function of time plotted for D5W, CPT, irinotecan and the three conjugates containing high MW polymer at their MTDs in xenograft mice.

Figure 12 shows the correlation of CPT concentration (ng/mg tissue) to  
5 tumor size (in mg) in xenograft mice.

## Detailed Description of the Invention

### I. Overview

The present invention relates to novel compositions of therapeutic  
10 cyclodextrin-containing polymeric compounds designed for drug delivery of  
therapeutic agents. In certain embodiments, these cyclodextrin-containing polymers  
improve drug stability and/or solubility, and/or reduce toxicity, and/or improve  
efficacy of the small molecule therapeutic when used in vivo. In certain  
embodiments, the polymers can be used for delivery of therapeutics such as  
15 camptothecin, taxol, doxorubicin, and amphotericin. Furthermore, by selecting from  
a variety of linker groups, and/or targeting ligands, the rate of drug release from the  
polymers can be attenuated for controlled delivery. The invention also relates to  
methods of treating subjects with the therapeutic compositions described herein.  
The invention further relates to methods for conducting a pharmaceutical business  
20 comprising manufacturing, licensing, or distributing kits containing or relating to the  
polymeric compounds described herein.

More generally, the present invention provides water-soluble, biocompatible  
polymer conjugates comprising a water-soluble, biocompatible polymer covalently  
attached to bioactive moieties through attachments that are cleaved under biological  
25 conditions to release the bioactive moieties. In certain such embodiments, the  
polymer comprises cyclic moieties alternating with linker moieties that connect the  
cyclic structures, e.g., into linear or branched polymers, preferably linear polymers.  
The cyclic moieties may be any suitable cyclic structures, such as cyclodextrins,  
crown ethers (e.g., 18-crown-6, 15-crown-5, 12-crown-4, etc.), cyclic oligopeptides  
30 (e.g., comprising from 5 to 10 amino acid residues), cryptands or cryptates (e.g.,  
cryptand [2.2.2], cryptand-2,1,1, and complexes thereof), calixarenes, or cavitands,



or any combination thereof. Preferably, the cyclic structure is (or is modified to be) water-soluble. In certain embodiments, e.g., where a linear polymer is desired, the cyclic structure is selected such that under polymerization conditions, exactly two moieties of each cyclic structure are reactive with the linker moieties, such that the  
5 resulting polymer comprises (or consists essentially of) an alternating series of cyclic moieties and linker moieties, such as at least four of each type of moiety. Suitable difunctionalized cyclic moieties include many that are commercially available and/or amenable to preparation using published protocols. In certain  
10 embodiments, conjugates are soluble in water to a concentration of at least 0.1 g/mL, preferably at least 0.25 g/mL.

The polymer may be a polycation, polyanion, or non-ionic polymer. A polycationic or polyanionic polymer has at least one site that bears a positive or negative charge, respectively. In certain such embodiments, at least one of the linker moiety and the cyclic moiety comprises such a charged site, so that every occurrence  
15 of that moiety includes a charged site.

The bioactive agent, which may be a therapeutic agent, a diagnostic agent, or an adjuvant (such as a radiosensitizer, or a compound that lacks significant activity administered alone but that potentiates the activity of another therapeutic agent), preferably makes up at least 5%, 10%, 15%, 20%, 25%, 30%, or even 35% by  
20 weight of the conjugate. In preferred embodiments, administration of the polymer to a patient results in release of the bioactive agent over a period of at least 6 hours, preferably at least 12 or 18 hours. For example, the agent may be released over a period of time ranging from 6 hours to a month, 6 hours to two weeks, 6 hours to 3 days, etc. In certain embodiments, the rate of drug release is dependent primarily  
25 upon the rate of hydrolysis (as opposed to enzymatic cleavage), e.g., the rate of release changes by less than a factor of 5, preferably less than a factor of 2, in the presence of hydrolytic enzymes. In other embodiments, the rate of drug release may be dependent primarily on the rate of enzymatic cleavage.

Polymeric conjugates of the present invention may be useful to improve  
30 solubility and/or stability of a bioactive/therapeutic agent, reduce drug-drug interactions, reduce interactions with blood elements including plasma proteins,



reduce or eliminate immunogenicity, protect the agent from metabolism, modulate drug-release kinetics, improve circulation time, improve drug half-life (e.g., in the serum, or in selected tissues, such as tumors), attenuate toxicity, improve efficacy, normalize drug metabolism across subjects of different species, ethnicities, and/or  
5 races, and/or provide for targeted delivery into specific cells or tissues. Poorly soluble and/or toxic compounds may benefit particularly from incorporation into polymeric compounds of the invention.

## II. Definitions

### (a) General Terms

10 An 'adjuvant', as the term is used herein, is a compound that has little or no therapeutic value on its own, but increases the effectiveness of a therapeutic agent. Exemplary adjuvants include radiosensitizers, transfection-enhancing agents (such as chloroquine and analogs thereof), chemotactic agents and chemoattractants, peptides that modulate cell adhesion and/or cell mobility, cell permeabilizing agents,  
15 inhibitors of multidrug resistance and/or efflux pumps, etc.

The term "agonist", as used herein, is meant to refer to an agent that mimics or up-regulates (e.g., potentiates or supplements) the bioactivity of a protein of interest, or an agent that facilitates or promotes (e.g., potentiates or supplements) an interaction among polypeptides or between a polypeptide and another molecule  
20 (e.g., a steroid, hormone, nucleic acids, small molecules etc.). An agonist can be a wild-type protein or derivative thereof having at least one bioactivity of the wild-type protein. An agonist can also be a small molecule that up-regulates the expression of a gene or which increases at least one bioactivity of a protein. An agonist can also be a protein or small molecule which increases the interaction of a  
25 polypeptide of interest with another molecule, e.g., a target peptide or nucleic acid.

"Antagonist" as used herein is meant to refer to an agent that down-regulates (e.g., suppresses or inhibits) the bioactivity of a protein of interest, or an agent that inhibits/suppresses or reduces (e.g., destabilizes or decreases) interaction among polypeptides or other molecules (e.g., steroids, hormones, nucleic acids, etc.). An  
30 antagonist can also be a compound that down-regulates the expression of a gene of

interest or which reduces the amount of the wild-type protein present. An antagonist can also be a protein or small molecule which decreases or inhibits the interaction of a polypeptide of interest with another molecule, e.g., a target peptide or nucleic acid.

The terms "biocompatible polymer" and "biocompatibility" when used in  
5 relation to polymers are art-recognized. For example, biocompatible polymers include polymers that are neither themselves toxic to the host (e.g., an animal or human), nor degrade (if the polymer degrades) at a rate that produces monomeric or oligomeric subunits or other byproducts at toxic concentrations in the host. In certain  
10 embodiments of the present invention, biodegradation generally involves degradation of the polymer in an organism, e.g., into its monomeric subunits, which may be known to be effectively non-toxic. Intermediate oligomeric products resulting from such degradation may have different toxicological properties, however, or biodegradation may involve oxidation or other biochemical reactions that generate molecules other than monomeric subunits of the polymer.  
15 Consequently, in certain embodiments, toxicology of a biodegradable polymer intended for in vivo use, such as implantation or injection into a patient, may be determined after one or more toxicity analyses. It is not necessary that any subject composition have a purity of 100% to be deemed biocompatible. Hence, a subject composition may comprise 99%, 98%, 97%, 96%, 95%, 90% 85%, 80%, 75% or  
20 even less of biocompatible polymers, e.g., including polymers and other materials and excipients described herein, and still be biocompatible.

To determine whether a polymer or other material is biocompatible, it may be necessary to conduct a toxicity analysis. Such assays are well known in the art. One example of such an assay may be performed with live carcinoma cells, such as  
25 GT3TKB tumor cells, in the following manner: the sample is degraded in 1 M NaOH at 37 °C until complete degradation is observed. The solution is then neutralized with 1 M HCl. About 200 µL of various concentrations of the degraded sample products are placed in 96-well tissue culture plates and seeded with human gastric carcinoma cells (GT3TKB) at 10<sup>4</sup>/well density. The degraded sample  
30 products are incubated with the GT3TKB cells for 48 hours. The results of the assay may be plotted as % relative growth vs. concentration of degraded sample in the



tissue-culture well. In addition, polymers and formulations of the present invention may also be evaluated by well-known in vivo tests, such as subcutaneous implantations in rats to confirm that they do not cause significant levels of irritation or inflammation at the subcutaneous implantation sites.

5           The term "biodegradable" is art-recognized, and includes polymers, compositions and formulations, such as those described herein, that are intended to degrade during use. Biodegradable polymers typically differ from non-  
10           biodegradable polymers in that the former may be degraded during use. In certain embodiments, such use involves in vivo use, such as in vivo therapy, and in other  
15           certain embodiments, such use involves in vitro use. In general, degradation attributable to biodegradability involves the degradation of a biodegradable polymer into its component subunits, or digestion, e.g., by a biochemical process, of the  
20           polymer into smaller, non-polymeric subunits. In certain embodiments, two different types of biodegradation may generally be identified. For example, one type of  
25           biodegradation may involve cleavage of bonds (whether covalent or otherwise) in the polymer backbone. In such biodegradation, monomers and oligomers typically result, and even more typically, such biodegradation occurs by cleavage of a bond  
30           connecting one or more of subunits of a polymer. In contrast, another type of biodegradation may involve cleavage of a bond (whether covalent or otherwise)  
                  internal to sidechain or that connects a side chain to the polymer backbone. For example, a therapeutic agent or other chemical moiety attached as a side chain to the polymer backbone may be released by biodegradation. In certain embodiments, one or the other or both general types of biodegradation may occur during use of a polymer.

25           As used herein, the term "biodegradation" encompasses both general types of biodegradation. The degradation rate of a biodegradable polymer often depends in part on a variety of factors, including the chemical identity of the linkage responsible for any degradation, the molecular weight, crystallinity, biostability, and degree of cross-linking of such polymer, the physical characteristics (e.g., shape and  
30           size) of an implant, and the mode and location of administration. For example, the greater the molecular weight, the higher the degree of crystallinity, and/or the



greater the biostability, the biodegradation of any biodegradable polymer is usually slower. The term "biodegradable" is intended to cover materials and processes also termed "bioerodible".

5 In certain embodiments wherein the biodegradable polymer also has a therapeutic agent or other material associated with it, the biodegradation rate of such polymer may be characterized by a release rate of such materials. In such circumstances, the biodegradation rate may depend on not only the chemical identity and physical characteristics of the polymer, but also on the identity of material(s) incorporated therein. Degradation of the subject compositions includes not only the  
10 cleavage of intramolecular bonds, e.g., by oxidation and/or hydrolysis, but also the disruption of intermolecular bonds, such as dissociation of host/guest complexes by competitive complex formation with foreign inclusion hosts.

In certain embodiments, polymeric formulations of the present invention biodegrade within a period that is acceptable in the desired application. In certain  
15 embodiments, such as in vivo therapy, such degradation occurs in a period usually less than about five years, one year, six months, three months, one month, fifteen days, five days, three days, or even one day on exposure to a physiological solution with a pH between 6 and 8 having a temperature of between 25 and 37 °C. In other embodiments, the polymer degrades in a period of between about one hour and  
20 several weeks, depending on the desired application.

As used herein the term "bioerodable" refers to polymers which deliver sustained effective amounts of therapeutic agent to target tissue over desired extended periods of time. Thus, a polymer according to the invention in the biological environment of host tissue and the like, in one aspect, is subjected to  
25 hydrolytic enzymes and oxidative species under, and in proportion to, the host's inflammatory response. This results in release of the therapeutic agent via the breaking of the covalent linked bonds. Thus, in certain embodiments, the materials of the invention utilize the mammal's own wound-healing repair process in being degraded thereby, as hereinbefore described.

The biodegradable polymers polylactic acid, polyglycolic acid, and polylactic-glycolic acid copolymer (PLGA), have been investigated extensively for nanoparticle formulation. These polymers are polyesters that, upon implantation in the body, undergo simple hydrolysis. The products of such hydrolysis are

5 biologically compatible and metabolizable moieties (e.g., lactic acid and glycolic acid), which are eventually removed from the body by the citric acid cycle. Polymer biodegradation products are formed at a very slow rate, and hence do not affect normal cell function. Several implant studies with these polymers have proven safe in drug delivery applications, used in the form of matrices, microspheres, bone

10 implant materials, surgical sutures, and also in contraceptive applications for long-term effects. These polymers are also used as graft materials for artificial organs, and recently as basement membranes in tissue engineering investigations. *Nature Med.* 824-826 (1996). Thus, these polymers have been time-tested in various applications and proven safe for human use. Most importantly, these polymers are

15 FDA-approved for human use.

When polymers are used for delivery of pharmacologically active agents in vivo, it is essential that the polymers themselves be nontoxic and that they degrade into non-toxic degradation products as the polymer is eroded by the body fluids. Many synthetic biodegradable polymers, however, yield oligomers and monomers

20 upon erosion in vivo that adversely interact with the surrounding tissue. D. F. Williams, *J. Mater. Sci.* 1233 (1982). To minimize the toxicity of the intact polymer carrier and its degradation products, polymers have been designed based on naturally occurring metabolites. Probably the most extensively studied examples of such polymers are the polyesters derived from lactic or glycolic acid and polyamides

25 derived from amino acids.

A number of bioerodable or biodegradable polymers are known and used for controlled release of pharmaceuticals. Such polymers are described in, for example, U.S. Pat. No. 4,291,013; U.S. Pat. No. 4,347,234; U.S. Pat. No. 4,525,495; U.S. Pat. No. 4,570,629; U.S. Pat. No. 4,572,832; U.S. Pat. No. 4,587,268;

30 U.S. Pat. No. 4,638,045; U.S. Pat. No. 4,675,381; U.S. Pat. No. 4,745,160; and U.S. Pat. No. 5,219,980.



A biohydrolyzable bond (e.g., ester, amide, carbonate, carbamates, or imide) refers to a bond that is cleaved (e.g., an ester is cleaved to form a hydroxyl and a carboxylic acid) under physiological conditions. Physiological conditions include the acidic and basic environments of the digestive tract (e.g., stomach, intestines, etc.), acidic environment of a tumor, enzymatic cleavage, metabolism, and other biological processes, and preferably refer to physiological conditions in a vertebrate, such as a mammal.

As used herein the terms "comonomer A precursor", "linker", "linker group", and "linker moiety" refer to any straight chain or branched, symmetric or asymmetric compound which upon reaction with a cyclodextrin monomer precursor or other suitable cyclic moiety links two such moieties together. In certain embodiments, a comonomer A precursor is a compound containing at least two functional groups through which reaction and thus linkage of the cyclodextrin monomers can be achieved. Examples of functional groups, which may be the same or different, terminal or internal, of each comonomer A precursor include, but are not limited, to amino, acid, imidazole, hydroxyl, thio, acyl halide,  $-C=C-$ , or  $-C\equiv C-$  groups and derivatives thereof. In preferred embodiments, the two functional groups are the same and are located at termini of the comonomer. In certain embodiments, a comonomer A precursor contains one or more pendant groups with at least one functional group through which reaction and thus linkage of therapeutic agent or targeting ligand can be achieved, or branched polymerization can be achieved. Examples of functional groups, which may be the same or different, terminal or internal, of each comonomer A precursor pendant group include, but are not limited, to amino, acid, imidazole, hydroxyl, thiol, acyl halide, ethylene, and ethyne groups and derivatives thereof. In certain embodiments, the pendant group is a (un)substituted branched, cyclic or straight chain C1-C10 (preferably C1-C6) alkyl, or arylalkyl optionally containing one or more heteroatoms, e.g., N, O, S, within the chain or ring.

Upon copolymerization of a comonomer A precursor with a cyclodextrin monomer precursor, two cyclodextrin monomers may be linked together by joining the primary hydroxyl side of one cyclodextrin monomer with the primary hydroxyl



side of another cyclodextrin monomer, by joining the secondary hydroxyl side of one cyclodextrin monomer with the secondary hydroxyl side of another cyclodextrin monomer, or by joining the primary hydroxyl side of one cyclodextrin monomer with the secondary hydroxyl side of another cyclodextrin monomer. Accordingly, combinations of such linkages may exist in the final copolymer. Both the comonomer A precursor and the comonomer A of the final copolymer may be neutral, cationic (e.g., by containing protonated groups such as, for example, quaternary ammonium groups), or anionic (e.g., by containing deprotonated groups, such as, for example, sulfate, phosphate, borinate or carboxylate). The charge of comonomer A of the copolymer may be adjusted by adjusting pH conditions. Examples of suitable comonomer A precursors include, but are not limited to succinimide (e.g., dithiobis(succinimidyl propionate) DSP, and dissuccinimidyl suberate (DSS)), glutamates, and aspartates).

The cyclodextrin-containing polymers of the present invention may be linear, branched or grafted. As used herein, the term "linear cyclodextrin-containing polymer" refers to a polymer comprising ( $\alpha$ ,  $\beta$ , or  $\gamma$ ) cyclodextrin molecules, or derivatives thereof which are inserted within a polymer chain. As used herein, the term "grafted cyclodextrin-containing polymer" refers to a polymer comprising ( $\alpha$ ,  $\beta$ , or  $\gamma$ ) cyclodextrin molecules, or derivatives thereof which are pendant off of the polymer chain. The term "graft polymer" as used herein refers to a polymer molecule which has additional moieties attached as pendent groups along a polymer backbone. The term "graft polymerization" denotes a polymerization in which a side chain is grafted onto a polymer chain, which side chain consists of one or several other monomers. The properties of the graft copolymer obtained such as, for example, solubility, melting point, water absorption, wettability, mechanical properties, adsorption behavior, etc., deviate more or less sharply from those of the initial polymer as a function of the type and amount of the grafted monomers. The term "grafting ratio", as used herein, means the weight percent of the amount of the monomers grafted based on the weight of the polymer. As used herein, a branched cyclodextrin-containing polymer refers to a polymer backbone with a plurality of branch points, wherein each branch point is a starting point of yet another strand of the polymer backbone, and each section of polymer backbone may have a plurality

of ( $\alpha$ ,  $\beta$ , or  $\gamma$ ) cyclodextrin molecules, or derivatives thereof, inserted into or grafted onto the chain.

The term "cyclodextrin moiety" refers to ( $\alpha$ ,  $\beta$ , or  $\gamma$ ) cyclodextrin molecules or derivatives thereof, which may be in their oxidized or reduced forms.

5 Cyclodextrin moieties may comprise optional linkers. Optional therapeutic agents and/or targeting ligands may be further linked to these moieties via an optional linker. The linkage may be covalent (optionally via biohydrolyzable bonds, e.g., esters, amides, carbamates, and carbonates) or may be a host-guest complex between the cyclodextrin derivative and the therapeutic agent and/or targeting ligand or the  
10 optional linkers of each. Cyclodextrin moieties may further include one or more carbohydrate moieties, preferably simple carbohydrate moieties such as galactose, attached to the cyclic core, either directly (i.e., via a carbohydrate linkage) or through a linker group.

The term "ED<sub>50</sub>" means the dose of a drug that produces 50% of its  
15 maximum response or effect.

An 'effective amount' of a subject compound, with respect to the subject method of treatment, refers to an amount of the therapeutic in a preparation which, when applied as part of a desired dosage regimen provides a benefit according to clinically acceptable standards for the treatment or prophylaxis of a particular  
20 disorder.

The term "healthcare providers" refers to individuals or organizations that provide healthcare services to a person, community, etc. Examples of "healthcare providers" include doctors, hospitals, continuing care retirement communities, skilled nursing facilities, subacute care facilities, clinics, multispecialty clinics,  
25 freestanding ambulatory centers, home health agencies, and HMO's.

"Instruction(s)" as used herein means documents describing relevant materials or methodologies pertaining to a kit. These materials may include any combination of the following: background information, list of components and their availability information (purchase information, etc.), brief or detailed protocols for



using the kit, trouble-shooting, references, technical support, and any other related documents. Instructions can be supplied with the kit or as a separate member component, either as a paper form or an electronic form which may be supplied on computer readable memory device or downloaded from an internet website, or as  
5 recorded presentation. Instructions can comprise one or multiple documents, and are meant to include future updates.

“Kit” as used herein means a collection of at least two components constituting the kit. Together, the components constitute a functional unit for a given purpose. Individual member components may be physically packaged  
10 together or separately. For example, a kit comprising an instruction for using the kit may or may not physically include the instruction with other individual member components. Instead, the instruction can be supplied as a separate member component, either in a paper form or an electronic form which may be supplied on computer readable memory device or downloaded from an internet website, or as  
15 recorded presentation.

The term “LD<sub>50</sub>” means the dose of a drug that is lethal in 50% of test subjects.

A “patient” or “subject” to be treated by the subject method can mean either a human or non-human subject.

20 The “polymerizations” of the present invention include radical, anionic, and cationic mechanisms, as well as reactions of bifunctional molecules (analogous to the formation of nylon, e.g., reacting molecules each of which bears two or more different reactive moieties that react with each other (but, preferably, are disfavored from reacting intramolecularly by steric, conformational, or other constraints), or  
25 reacting two or more different compounds, each compound bearing two or more reactive moieties that react only with reactive moieties of different compounds (i.e., intermolecularly)), as well as metal-catalyzed polymerizations such as olefin metathesis, and other polymerization reactions known to those of skill in the art.



The term "prophylactic or therapeutic" treatment is art-recognized and includes administration to the host of one or more of the subject compositions. If it is administered prior to clinical manifestation of the unwanted condition (e.g., disease or other unwanted state of the host animal) then the treatment is prophylactic, i.e., it protects the host against developing the unwanted condition, whereas if it is administered after manifestation of the unwanted condition, the treatment is therapeutic, (i.e., it is intended to diminish, ameliorate, or stabilize the existing unwanted condition or side effects thereof).

The term "preventing" is art-recognized, and when used in relation to a condition, such as a local recurrence (e.g., pain), a disease such as cancer, a syndrome complex such as heart failure or any other medical condition, is well understood in the art, and includes administration of a composition which reduces the frequency of, or delays the onset of, symptoms of a medical condition in a subject relative to a subject which does not receive the composition. Thus, prevention of cancer includes, for example, reducing the number of detectable cancerous growths in a population of patients receiving a prophylactic treatment relative to an untreated control population, and/or delaying the appearance of detectable cancerous growths in a treated population versus an untreated control population, e.g., by a statistically and/or clinically significant amount. Prevention of an infection includes, for example, reducing the number of diagnoses of the infection in a treated population versus an untreated control population, and/or delaying the onset of symptoms of the infection in a treated population versus an untreated control population. Prevention of pain includes, for example, reducing the frequency of, or alternatively delaying, pain sensations experienced by subjects in a treated population versus an untreated control population.

As used herein, the terms "therapeutic agent" include any synthetic or naturally occurring biologically active compound or composition of matter which, when administered to an organism (human or nonhuman animal), induces a desired pharmacologic, immunogenic, and/or physiologic effect by local and/or systemic action. The term therefore encompasses those compounds or chemicals traditionally regarded as drugs, vaccines, and biopharmaceuticals including molecules such as

proteins, peptides, hormones, nucleic acids, gene constructs and the like. More particularly, the term "therapeutic agent" includes compounds or compositions for use in all of the major therapeutic areas including, but not limited to, adjuvants; anti-infectives such as antibiotics and antiviral agents; analgesics and analgesic combinations, anorexics, anti-inflammatory agents, anti-epileptics, local and general anesthetics, hypnotics, sedatives, antipsychotic agents, neuroleptic agents, antidepressants, anxiolytics, antagonists, neuron blocking agents, anticholinergic and cholinomimetic agents, antimuscarinic and muscarinic agents, antiadrenergics, antiarrhythmics, antihypertensive agents, hormones, and nutrients, antiarthritics, antiasthmatic agents, anticonvulsants, antihistamines, anti-nauseants, antineoplastics, antipruritics, antipyretics; antispasmodics, cardiovascular preparations (including calcium channel blockers, beta-blockers, beta-agonists and antiarrhythmics), antihypertensives, diuretics, vasodilators; central nervous system stimulants; cough and cold preparations; decongestants; diagnostics; hormones; bone growth stimulants and bone resorption inhibitors; immunosuppressives; muscle relaxants; psychostimulants; sedatives; tranquilizers; proteins, peptides, and fragments thereof (whether naturally occurring, chemically synthesized or recombinantly produced); and nucleic acid molecules (polymeric forms of two or more nucleotides, either ribonucleotides (RNA) or deoxyribonucleotides (DNA) including both double- and single-stranded molecules, gene constructs, expression vectors, antisense molecules and the like), small molecules (e.g., doxorubicin) and other biologically active macromolecules such as, for example, proteins and enzymes. The agent may be a biologically active agent used in medical, including veterinary, applications and in agriculture, such as with plants, as well as other areas. The term therapeutic agent also includes without limitation, medicaments; vitamins; mineral supplements; substances used for the treatment, prevention, diagnosis, cure or mitigation of disease or illness; or substances which affect the structure or function of the body; or pro-drugs, which become biologically active or more active after they have been placed in a predetermined physiological environment.

30 As used herein the term "low aqueous solubility" refers to water insoluble compounds having poor solubility in water, that is <5 mg/ml at physiological pH (6.5-7.4). Preferably, their water solubility is <1 mg/ml, more preferably <0.1



mg/ml. It is desirable that the drug is stable in water as a dispersion; otherwise a lyophilized or spray-dried solid form may be desirable.

Examples of some preferred water-insoluble drugs include immunosuppressive agents such as cyclosporins including cyclosporine (cyclosporin  
5 A), immunoactive agents, antiviral and antifungal agents, antineoplastic agents, analgesic and anti-inflammatory agents, antibiotics, anti-epileptics, anesthetics, hypnotics, sedatives, antipsychotic agents, neuroleptic agents, antidepressants, anxiolytics, anticonvulsant agents, antagonists, neuron blocking agents, anticholinergic and cholinomimetic agents, antimuscarinic and muscarinic agents,  
10 antiadrenergic and antiarrhythmics, antihypertensive agents, hormones, and nutrients. A detailed description of these and other suitable drugs may be found in Remington's Pharmaceutical Sciences, 18th edition, 1990, Mack Publishing Co. Philadelphia, Pa

The term "therapeutic index" refers to the therapeutic index of a drug defined  
15 as  $LD_{50}/ED_{50}$ .

A "therapeutically effective amount" of a compound, with respect to a method of treatment, refers to an amount of the compound(s) in a preparation which, when administered as part of a desired dosage regimen (to a mammal, preferably a human) alleviates a symptom, ameliorates a condition, or slows the onset of disease  
20 conditions according to clinically acceptable standards for the disorder or condition to be treated or the cosmetic purpose, e.g., at a reasonable benefit/risk ratio applicable to any medical treatment.

A "therapeutically effective daily dosage" of a compound, with respect to a method of treatment, refers to an amount of the compound(s) in a preparation which, when administered as part of a desired daily dosage regimen (to a mammal,  
25 preferably a human) alleviates a symptom, ameliorates a condition, or slows the onset of disease conditions according to clinically acceptable standards for the disorder or condition to be treated or the cosmetic purpose, e.g., at a reasonable benefit/risk ratio applicable to any medical treatment.

30 (b) Chemical Terms

An aliphatic chain comprises the classes of alkyl, alkenyl and alkynyl defined below. A straight aliphatic chain is limited to unbranched carbon chain radicals. As used herein, the term "aliphatic group" refers to a straight chain, branched-chain, or cyclic aliphatic hydrocarbon group and includes saturated and  
5 unsaturated aliphatic groups, such as an alkyl group, an alkenyl group, and an alkynyl group.

Alkyl refers to a fully saturated branched or unbranched carbon chain radical having the number of carbon atoms specified, or up to 30 carbon atoms if no specification is made. For example, alkyl of 1 to 8 carbon atoms refers to radicals  
10 such as methyl, ethyl, propyl, butyl, pentyl, hexyl, heptyl, and octyl, and those radicals which are positional isomers of these radicals. Alkyl of 10 to 30 carbon atoms includes decyl, undecyl, dodecyl, tridecyl, tetradecyl, pentadecyl, hexadecyl, heptadecyl, octadecyl, nonadecyl, eicosyl, heneicosyl, docosyl, tricosyl and tetracosyl. In preferred embodiments, a straight chain or branched chain alkyl has  
15 30 or fewer carbon atoms in its backbone (e.g., C1-C30 for straight chains, C3-C30 for branched chains), and more preferably 20 or fewer. Likewise, preferred cycloalkyls have from 3-10 carbon atoms in their ring structure, and more preferably have 5, 6 or 7 carbons in the ring structure.

Moreover, the term "alkyl" (or "lower alkyl") as used throughout the  
20 specification, examples, and claims is intended to include both "unsubstituted alkyls" and "substituted alkyls", the latter of which refers to alkyl moieties having substituents replacing a hydrogen on one or more carbons of the hydrocarbon backbone. Such substituents can include, for example, a halogen, a hydroxyl, a carbonyl (such as a carboxyl, an alkoxy carbonyl, a formyl, or an acyl), a  
25 thiocarbonyl (such as a thioester, a thioacetate, or a thioformate), an alkoxy, a phosphoryl, a phosphate, a phosphonate, a phosphinate, an amino, an amido, an amidine, a cyano, a nitro, a sulfhydryl, an alkylthio, a sulfate, a sulfonate, a sulfamoyl, a sulfonamido, a sulfonyl, a heterocyclyl, an aralkyl, or an aromatic or  
30 heteroaromatic moiety. It will be understood by those skilled in the art that the moieties substituted on the hydrocarbon chain can themselves be substituted, if appropriate. For instance, the substituents of a substituted alkyl may include substituted and unsubstituted forms of amino, azido, imino, amido, phosphoryl



(including phosphonate and phosphinate), sulfonyl (including sulfate, sulfonamido, sulfamoyl and sulfonate), and silyl groups, as well as ethers, alkylthios, carbonyls (including ketones, aldehydes, carboxylates, and esters), -CF<sub>3</sub>, -CN and the like. Exemplary substituted alkyls are described below. Cycloalkyls can be further substituted with alkyls, alkenyls, alkoxy, alkylthios, aminoalkyls, carbonyl-substituted alkyls, -CF<sub>3</sub>, -CN, and the like.

Unless the number of carbons is otherwise specified, "lower alkyl", as used herein, means an alkyl group, as defined above, but having from one to ten carbons, more preferably from one to six carbon atoms in its backbone structure such as methyl, ethyl, n-propyl, isopropyl, n-butyl, isobutyl, sec-butyl, and tert-butyl. Likewise, "lower alkenyl" and "lower alkynyl" have similar chain lengths. Throughout the application, preferred alkyl groups are lower alkyls. In preferred embodiments, a substituent designated herein as alkyl is a lower alkyl.

The term "alkylthio" refers to an alkyl group, as defined above, having a sulfur radical attached thereto. In preferred embodiments, the "alkylthio" moiety is represented by one of -(S)-alkyl, -(S)-alkenyl, -(S)-alkynyl, and -(S)-(CH<sub>2</sub>)<sub>m</sub>-R<sub>1</sub>, wherein m and R<sub>1</sub> are defined below. Representative alkylthio groups include methylthio, ethylthio, and the like.

Alkenyl refers to any branched or unbranched unsaturated carbon chain radical having the number of carbon atoms specified, or up to 26 carbon atoms if no limitation on the number of carbon atoms is specified; and having 1 or more double bonds in the radical. Alkenyl of 6 to 26 carbon atoms is exemplified by hexenyl, heptenyl, octenyl, nonenyl, decenyl, undecenyl, dodenyl, tridecenyl, tetradecenyl, pentadecenyl, hexadecenyl, heptadecenyl, octadecenyl, nonadecenyl, eicosenyl, heneicosenyl, docosenyl, tricosenyl and tetracosenyl, in their various isomeric forms, where the unsaturated bond(s) can be located anywhere in the radical and can have either the (Z) or the (E) configuration about the double bond(s).

Alkynyl refers to hydrocarbyl radicals of the scope of alkenyl, but having 1 or more triple bonds in the radical.

The terms "alkoxy" or "alkoxy" as used herein refers to an alkyl group, as defined below, having an oxygen radical attached thereto. Representative alkoxy

groups include methoxy, ethoxy, propoxy, tert-butoxy and the like. An "ether" is two hydrocarbons covalently linked by an oxygen. Accordingly, the substituent of an alkyl that renders that alkyl an ether is or resembles an alkoxy, such as can be represented by one of -O-alkyl, -O-alkenyl, -O-alkynyl, -O-(CH<sub>2</sub>)<sub>m</sub>-R<sub>1</sub>, where m and R<sub>1</sub> are described below.

The terms "amine" and "amino" are art-recognized and refer to both unsubstituted and substituted amines, e.g., a moiety that can be represented by the general formulae:

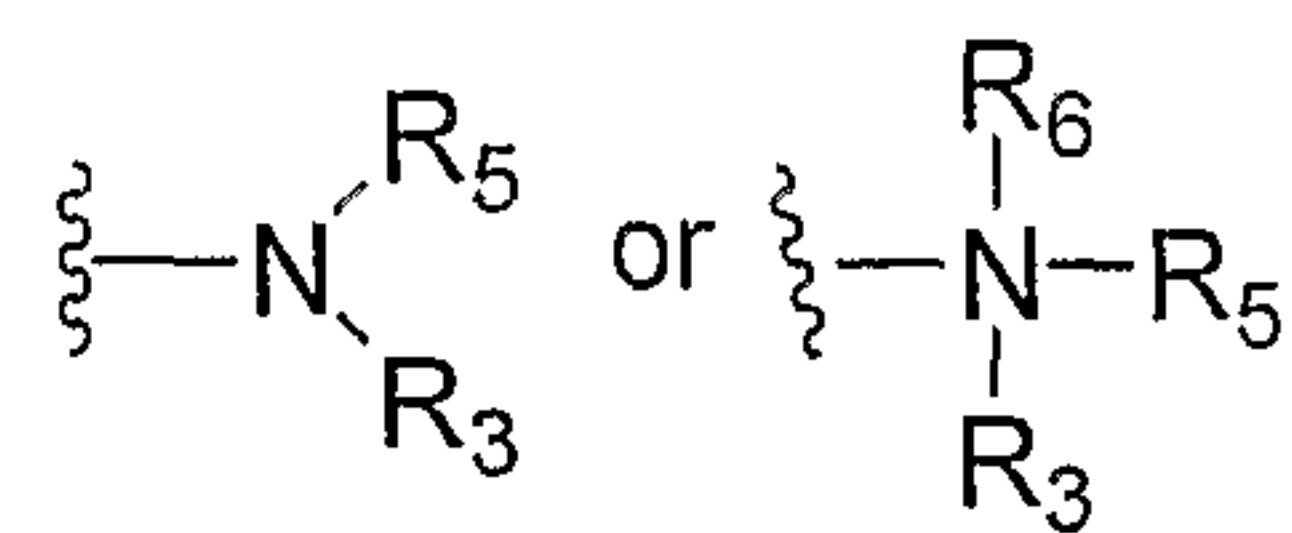

wherein R<sub>3</sub>, R<sub>5</sub> and R<sub>6</sub> each independently represent a hydrogen, an alkyl, an alkenyl, -(CH<sub>2</sub>)<sub>m</sub>-R<sub>1</sub>, or R<sub>3</sub> and R<sub>5</sub> taken together with the N atom to which they are attached complete a heterocycle having from 4 to 8 atoms in the ring structure; R<sub>1</sub> represents an alkenyl, aryl, cycloalkyl, a cycloalkenyl, a heterocyclyl or a polycyclyl; and m is zero or an integer in the range of 1 to 8. In preferred embodiments, only one of R<sub>3</sub> or R<sub>5</sub> can be a carbonyl, e.g., R<sub>3</sub>, R<sub>5</sub> and the nitrogen together do not form an imide. In even more preferred embodiments, R<sub>3</sub> and R<sub>5</sub> (and optionally R<sub>6</sub>) each independently represent a hydrogen, an alkyl, an alkenyl, or -(CH<sub>2</sub>)<sub>m</sub>-R<sub>1</sub>. Thus, the term "alkylamine" as used herein means an amine group, as defined above, having a substituted or unsubstituted alkyl attached thereto, i.e., at least one of R<sub>3</sub> and R<sub>5</sub> is an alkyl group. In certain embodiments, an amino group or an alkylamine is basic, meaning it has a pK<sub>a</sub> > 7.00. The protonated forms of these functional groups have pK<sub>a</sub>s relative to water above 7.00.

The term "carbonyl" is art-recognized and includes such moieties as can be represented by the general formula:

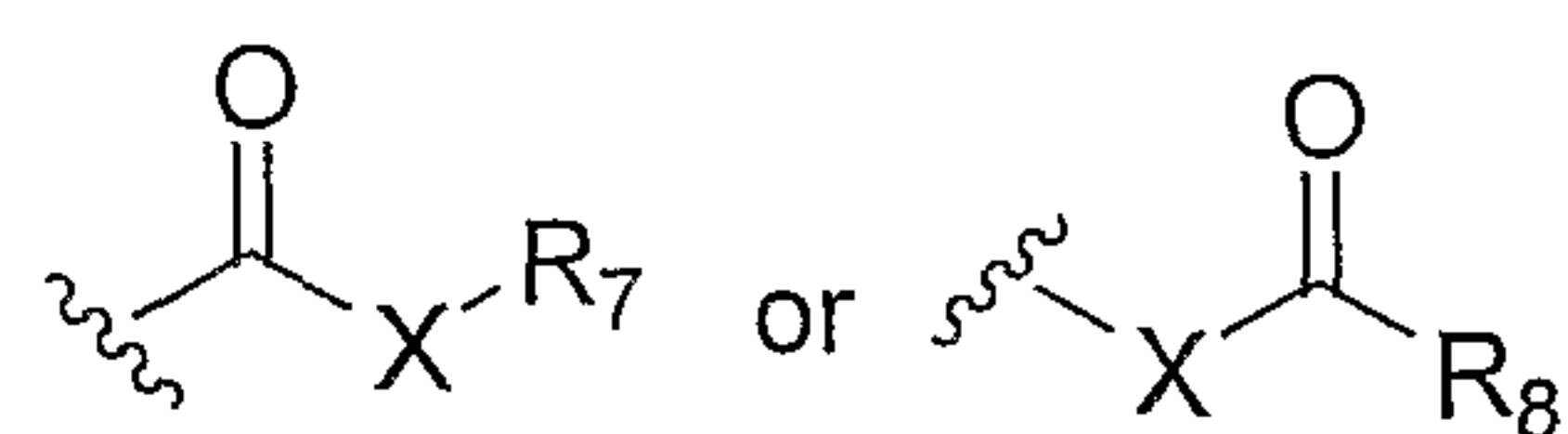



wherein X is a bond or represents an oxygen or a sulfur, and R7 represents a hydrogen, an alkyl, an alkenyl,  $-(CH_2)_m-R_1$  or a pharmaceutically acceptable salt, R8 represents a hydrogen, an alkyl, an alkenyl or  $-(CH_2)_m-R_1$ , where m and R1 are as defined above. Where X is an oxygen and R7 or R8 is not hydrogen, the formula represents an "ester". Where X is an oxygen, and R7 is as defined above, the moiety is referred to herein as a carboxyl group, and particularly when R7 is a hydrogen, the formula represents a "carboxylic acid". Where X is an oxygen, and R8 is hydrogen, the formula represents a "formate". In general, where the oxygen atom of the above formula is replaced by sulfur, the formula represents a "thiocarbonyl" group. Where X is a sulfur and R7 or R8 is not hydrogen, the formula represents a "thioester" group. Where X is a sulfur and R7 is hydrogen, the formula represents a "thiocarboxylic acid" group. Where X is a sulfur and R8 is hydrogen, the formula represents a "thioformate" group. On the other hand, where X is a bond, and R7 is not hydrogen, the above formula represents a "ketone" group. Where X is a bond, and R7 is hydrogen, the above formula represents an "aldehyde" group.

The term "derivatized" refers to chemically modifying molecules. The chemical modifications may be artificial such as formation of drugs, natural such as formation of metabolites. The skilled artisan would readily recognize the variety of ways molecules may be modified, such as oxidations, reductions, electrophilic/nucleophilic substitutions, alkylations, ester/amide formations and the like. For example, cyclodextrins of the present invention may be chemically modified by amination, tosylation, or iodination prior to covalently attaching them to the polymeric matrix. Likewise, therapeutic agents may be chemically modified by preparing prodrugs (e.g., glycine-camptothecin).

The terms "heterocyclyl" or "heterocyclic group" refer to 3- to 10-membered ring structures, more preferably 3- to 7-membered rings, whose ring structures include one to four heteroatoms. Heterocycles can also be polycycles. Heterocyclyl groups include, for example, thiophene, thianthrene, furan, pyran, isobenzofuran, chromene, xanthene, phenoxathiin, pyrrole, imidazole, pyrazole, isothiazole, isoxazole, pyridine, pyrazine, pyrimidine, pyridazine, indolizine, isoindole, indole, indazole, purine, quinolizine, isoquinoline, quinoline, phthalazine, naphthyridine,

quinoxaline, quinazoline, cinnoline, pteridine, carbazole, carboline, phenanthridine, acridine, pyrimidine, phenanthroline, phenazine, phenarsazine, phenothiazine, furazan, phenoxazine, pyrrolidine, oxolane, thiolane, oxazole, piperidine, piperazine, morpholine, lactones, lactams such as azetidinones and pyrrolidinones, sultams, 5 sultones, and the like. The heterocyclic ring can be substituted at one or more positions with such substituents as described above, as for example, halogen, alkyl, aralkyl, alkenyl, alkynyl, cycloalkyl, hydroxyl, amino, nitro, sulfhydryl, imino, amido, phosphate, phosphonate, phosphinate, carbonyl, carboxyl, silyl, sulfamoyl, sulfinyl, ether, alkylthio, sulfonyl, ketone, aldehyde, ester, a heterocyclyl, an 10 aromatic or heteroaromatic moiety, -CF<sub>3</sub>, -CN, or the like.

As used herein, the term "substituted" is contemplated to include all permissible substituents of organic compounds. In a broad aspect, the permissible substituents include acyclic and cyclic, branched and unbranched, carbocyclic and heterocyclic, aromatic and nonaromatic substituents of organic compounds. 15 Illustrative substituents include, for example, those described herein above. The permissible substituents can be one or more and the same or different for appropriate organic compounds. For purposes of this invention, the heteroatoms such as nitrogen may have hydrogen substituents and/or any permissible substituents of organic compounds described herein which satisfy the valences of the heteroatoms. 20 This invention is not intended to be limited in any manner by the permissible substituents of organic compounds.

The term "hydrocarbyl" refers to a monovalent hydrocarbon radical comprised of carbon chains or rings of up to 26 carbon atoms to which hydrogen atoms are attached. The term includes alkyl, cycloalkyl, alkenyl, alkynyl and aryl 25 groups, groups which have a mixture of saturated and unsaturated bonds, carbocyclic rings and includes combinations of such groups. It may refer to straight chain, branched-chain, cyclic structures or combinations thereof.

The term "hydrocarbylene" refers to a divalent hydrocarbyl radical. Representative examples include alkylene, phenylene, or cyclohexylene. Preferably, 30 the hydrocarbylene chain is fully saturated and/or has a chain of 1-10 carbon atoms.



As used herein, the term "nitro" means  $\text{-NO}_2$ ; the term "halogen" designates  $\text{-F}$ ,  $\text{-Cl}$ ,  $\text{-Br}$  or  $\text{-I}$ ; the term "sulfhydryl" means  $\text{-SH}$ ; the term "hydroxyl" means  $\text{-OH}$ ; and the term "sulfonyl" means  $\text{-SO}_2\text{-}$ .

It will be understood that "substitution" or "substituted with" includes the  
5 implicit proviso that such substitution is in accordance with permitted valence of the substituted atom and the substituent, and that the substitution results in a stable compound, e.g., which does not spontaneously undergo transformation such as by rearrangement, cyclization, elimination, etc.

Analogous substitutions can be made to alkenyl and alkynyl groups to  
10 produce, for example, aminoalkenyls, aminoalkynyls, amidoalkenyls, amidoalkynyls, iminoalkenyls, iminoalkynyls, thioalkenyls, thioalkynyls, carbonyl-substituted alkenyls or alkynyls.

As used herein, the definition of each expression, e.g., alkyl, m, n, etc., when  
it occurs more than once in any structure, is intended to be independent of its  
15 definition elsewhere in the same structure.

The terms triflyl, tosyl, mesyl, and nonaflyl are art-recognized and refer to trifluoromethanesulfonyl, *p*-toluenesulfonyl, methanesulfonyl, and nonafluorobutanesulfonyl groups, respectively. The terms triflate, tosylate, mesylate, and nonaflate are art-recognized and refer to trifluoromethanesulfonate  
20 ester, *p*-toluenesulfonate ester, methanesulfonate ester, and nonafluorobutanesulfonate ester functional groups and molecules that contain said groups, respectively.

The abbreviations Me, Et, Ph, Ms represent methyl, ethyl, phenyl, and methanesulfonyl, respectively. A more comprehensive list of the abbreviations  
25 utilized by organic chemists of ordinary skill in the art appears in the first issue of each volume of the Journal of Organic Chemistry; this list is typically presented in a table entitled Standard List of Abbreviations.

Certain compounds of the present invention may exist in particular geometric or stereoisomeric forms. The present invention contemplates all such compounds, including cis- and trans-isomers, (R)- and (S)-enantiomers, diastereomers, (d)-isomers, (l)-isomers, the racemic mixtures thereof, and other mixtures thereof, as  
5 falling within the scope of the invention. Additional asymmetric carbon atoms may be present in a substituent such as an alkyl group. All such isomers, as well as mixtures thereof, are intended to be included in this invention.

If, for instance, a particular enantiomer of a compound of the present invention is desired, it may be prepared by asymmetric synthesis, or by  
10 derivatization with a chiral auxiliary, where the resulting diastereomeric mixture is separated and the auxiliary group cleaved to provide the pure desired enantiomers. Alternatively, where the molecule contains a basic functional group, such as amino, or an acidic functional group, such as carboxyl, diastereomeric salts may be formed with an appropriate optically active acid or base, followed by resolution of the  
15 diastereomers thus formed by fractional crystallization or chromatographic means well known in the art, and subsequent recovery of the pure enantiomers.

Contemplated equivalents of the compounds described above include compounds which otherwise correspond thereto, and which have the same general properties thereof, wherein one or more simple variations of substituents are made  
20 which do not adversely affect the efficacy of the compound. In general, the compounds of the present invention may be prepared by the methods illustrated in the general reaction schemes as, for example, described below, or by modifications thereof, using readily available starting materials, reagents and conventional synthesis procedures. In these reactions, it is also possible to make use of variants  
25 which are in themselves known, but are not mentioned here.

For purposes of this invention, the chemical elements are identified in accordance with the Periodic Table of the Elements, CAS version, Handbook of Chemistry and Physics, 67th Ed., 1986-87, inside cover. Also for purposes of this invention, the term "hydrocarbon" is contemplated to include all permissible  
30 compounds having at least one hydrogen and one carbon atom. In a broad aspect, the permissible hydrocarbons include acyclic and cyclic, branched and unbranched,



carbocyclic and heterocyclic, aromatic and nonaromatic organic compounds which can be substituted or unsubstituted.

### III. Exemplary Applications of Method and Compositions

#### 5 (a) Exemplary Compositions

The present invention includes polymer conjugates, such as cyclodextrin-containing polymer conjugates, wherein one or more therapeutic/bioactive agents are covalently attached. In certain embodiments, the therapeutic agent is a small molecule, a macromolecule, an antibody, a peptide, a protein, an enzyme, a nucleic acid, or a polymer that has therapeutic function. The polymers include linear or branched cyclodextrin-containing polymers and polymers grafted with cyclodextrin. Exemplary cyclodextrin-containing polymers that may be modified as described herein are taught in U.S. Patent No. 6,509,323, published U.S. application No. 20020151523, and U.S. patent application serial No.s 60/417373, and 10/372723. These polymers are useful as carriers for small molecule therapeutic delivery, and may improve drug stability and solubility when used in vivo.

Accordingly, one embodiment of present invention is a polymeric compound represented by Formula I:

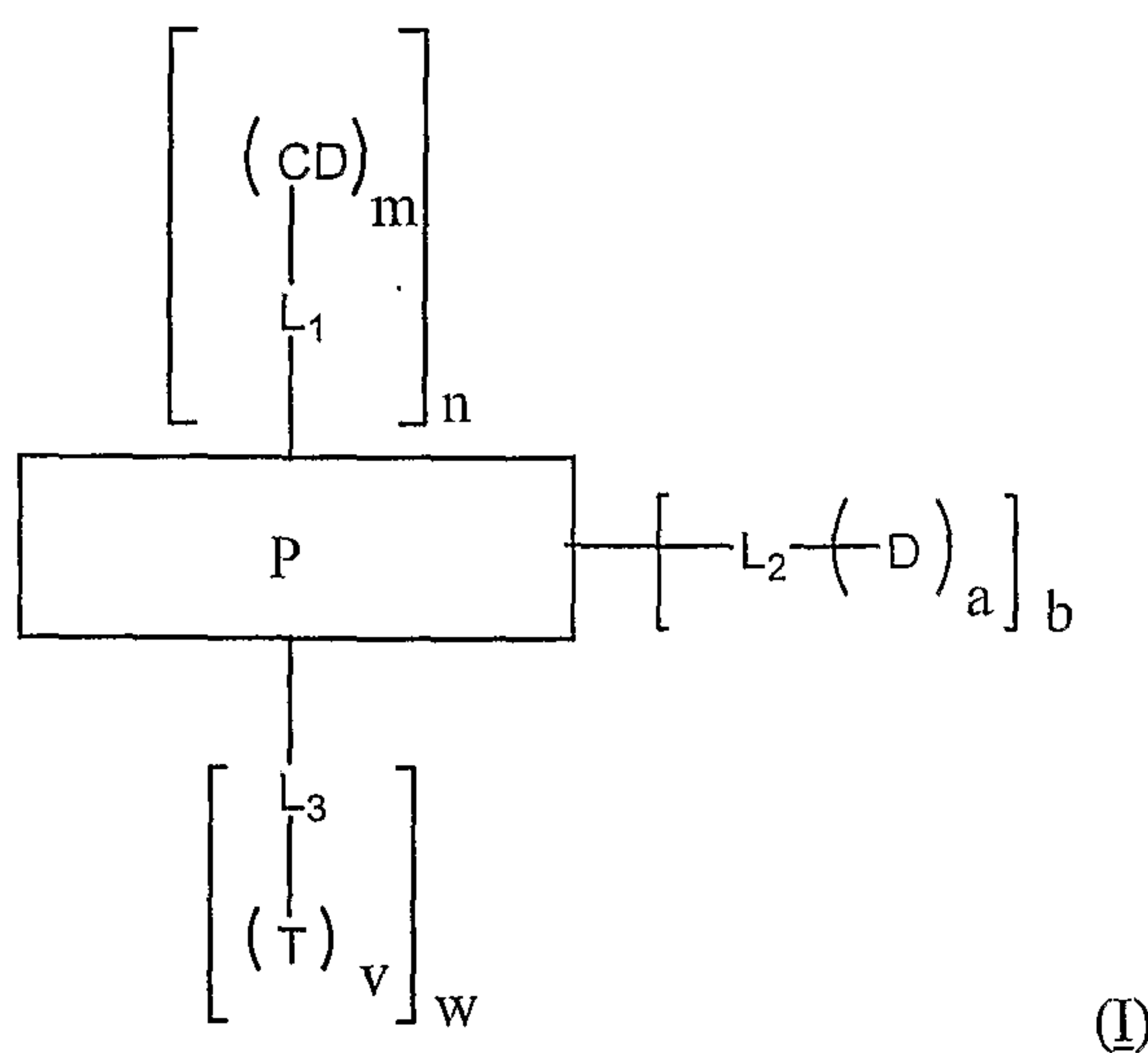

20

wherein

P represents a linear or branched polymer chain;

CD represents a cyclic moiety such as a cyclodextrin moiety;

5 L<sub>1</sub>, L<sub>2</sub> and L<sub>3</sub>, independently for each occurrence, may be absent or represent a linker group;

D, independently for each occurrence, represents a therapeutic agent or a prodrug thereof;

10 T, independently for each occurrence, represents a targeting ligand or precursor thereof;

a, m, and v, independently for each occurrence, represent integers in the range of 1 to 10 (preferably 1 to 8, 1 to 5, or even 1 to 3);

15 n and w, independently for each occurrence, represent an integer in the range of 0 to about 30,000 (preferably <25,000, <20,000, <15,000, <10,000, <5,000, <1,000, <500, <100, <50, <25, <10, or even <5); and

b represents an integer in the range of 1 to about 30,000 (preferably <25,000, <20,000, <15,000, <10,000, <5,000, <1,000, <500, <100, <50, <25, <10, or even <5),

wherein either P comprises cyclodextrin moieties or n is at least 1.

20

In certain embodiments, P contains a plurality of cyclodextrin moieties within the polymer chain as opposed to the cyclodextrin moieties being grafted on to pendant groups off of the polymeric chain. Thus in certain embodiments, the polymer chain of formula I further comprises n' units of U, 25 wherein n' represents an integer in the range of 1 to about 30,000 (preferably <25,000, <20,000, <15,000, <10,000, <5,000, <1,000, <500, <100, <50, <25, <10, or even <5); and U is represented by the general formula:



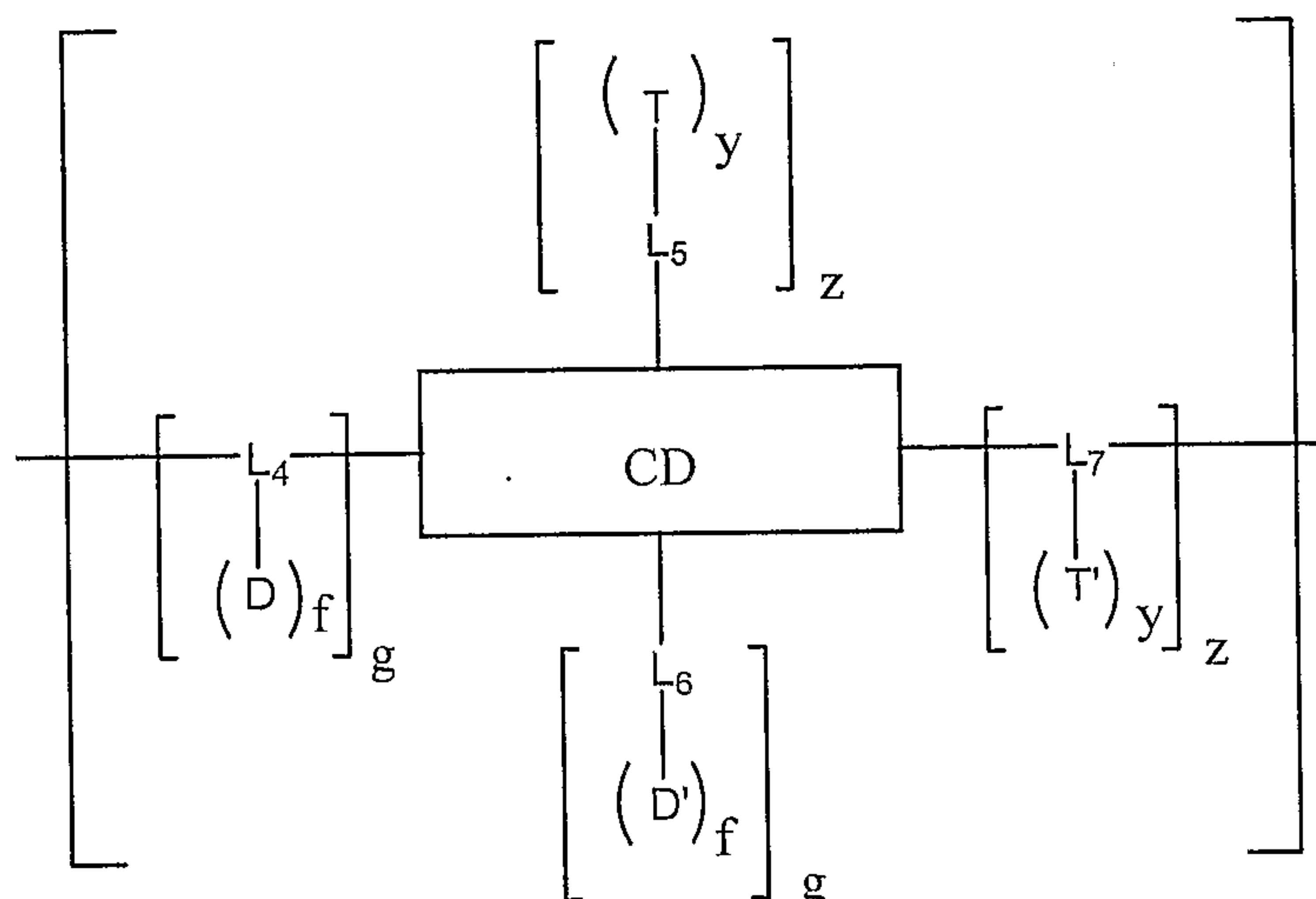

wherein

CD represents a cyclic moiety, such as a cyclodextrin moiety, or derivative thereof;

L<sub>4</sub>, L<sub>5</sub>, L<sub>6</sub>, and L<sub>7</sub>, independently for each occurrence, may be absent or represent a linker group;

D and D', independently for each occurrence, represent the same or different therapeutic agent or prodrug forms thereof;

T and T', independently for each occurrence, represent the same or different targeting ligand or precursor thereof;

f and y, independently for each occurrence, represent an integer in the range of 1 and 10; and

g and z, independently for each occurrence, represent an integer in the range of 0 and 10.

In preferred embodiments, L<sub>4</sub> and L<sub>7</sub> represent linker groups.

In certain embodiments, the polymer may be selected from polysaccharides, and other non-protein biocompatible polymers, and combinations thereof, that contain at least one terminal hydroxyl group, such as polyvinylpyrrolidone, poly(oxyethylene)glycol (PEG), polysuccinic anhydride, polysebacic acid, PEG-phosphate, polyglutamate, polyethylenimine, maleic anhydride divinylether (DIVMA), cellulose, pullulans, inulin, polyvinyl alcohol (PVA), N-(2-

hydroxypropyl) methacrylamide (HPMA), dextran and hydroxyethyl starch (HES), and have optional pendant groups for grafting therapeutic agents, targeting ligands and/or cyclodextrin moieties. In certain embodiments, the polymer may be biodegradable such as poly(lactic acid), poly(glycolic acid), poly(alkyl 2-cyanoacrylates), polyanhydrides, and polyorthoesters, or bioerodible such as polylactide-glycolide copolymers, and derivatives thereof, non-peptide polyaminoacids, polyiminocarbonates, poly alpha-amino acids, polyalkyl-cyanoacrylate, polyphosphazenes or acyloxymethyl poly aspartate and polyglutamate copolymers and mixtures thereof.

10

Another embodiment of the invention is a polymeric compound represented by Formula II:

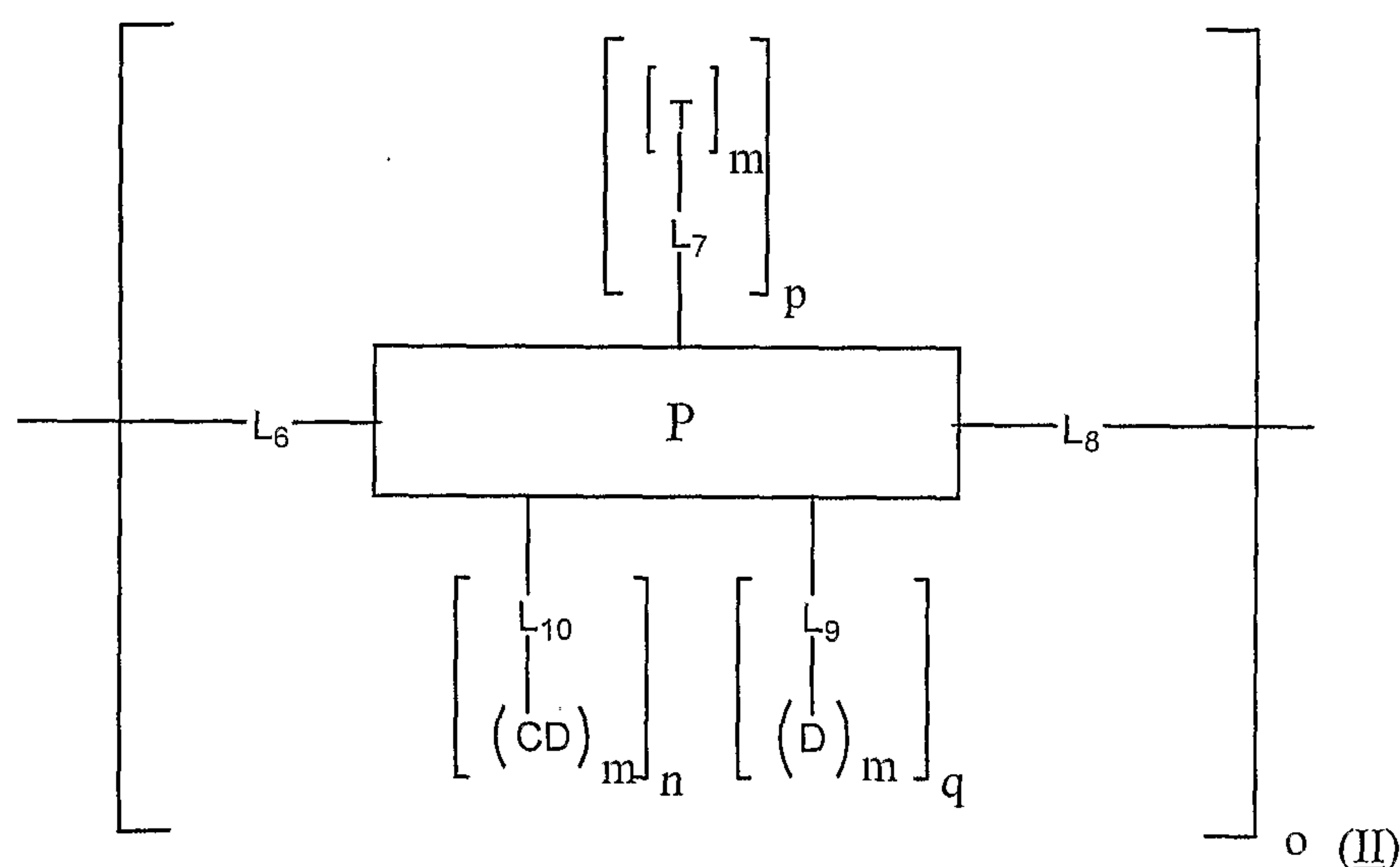

15

wherein

P represents a monomer unit of a polymer;

T, independently for each occurrence, represents a targeting ligand or a precursor thereof;

L<sub>6</sub>, L<sub>7</sub>, L<sub>8</sub>, L<sub>9</sub>, and L<sub>10</sub>, independently for each occurrence, may be absent or represent a linker group;

20



CD, independently for each occurrence, represents a cyclodextrin moiety or a derivative thereof;

D, independently for each occurrence, represents a therapeutic agent or a prodrug form thereof;

5 m, independently for each occurrence, represents an integer in the range of 1 to 10 (preferably 1 to 8, 1 to 5, or even 1 to 3);

o represents an integer in the range of 1 to about 30,000 (preferably <25,000, <20,000, <15,000, <10,000, <5,000, <1,000, <500, <100, <50, <25, <10, or even <5); and

10 p, n, and q, independently for each occurrence, represent an integer in the range of 0 to 10 (preferably 0 to 8, 0 to 5, 0 to 3, or even 0 to about 2),

wherein CD and D are preferably each present at at least 1 location (preferably at least 5, 10, 25, or even 50 or 100 locations) in the compound.

15 Another embodiment of the invention is a compound represented by Formula

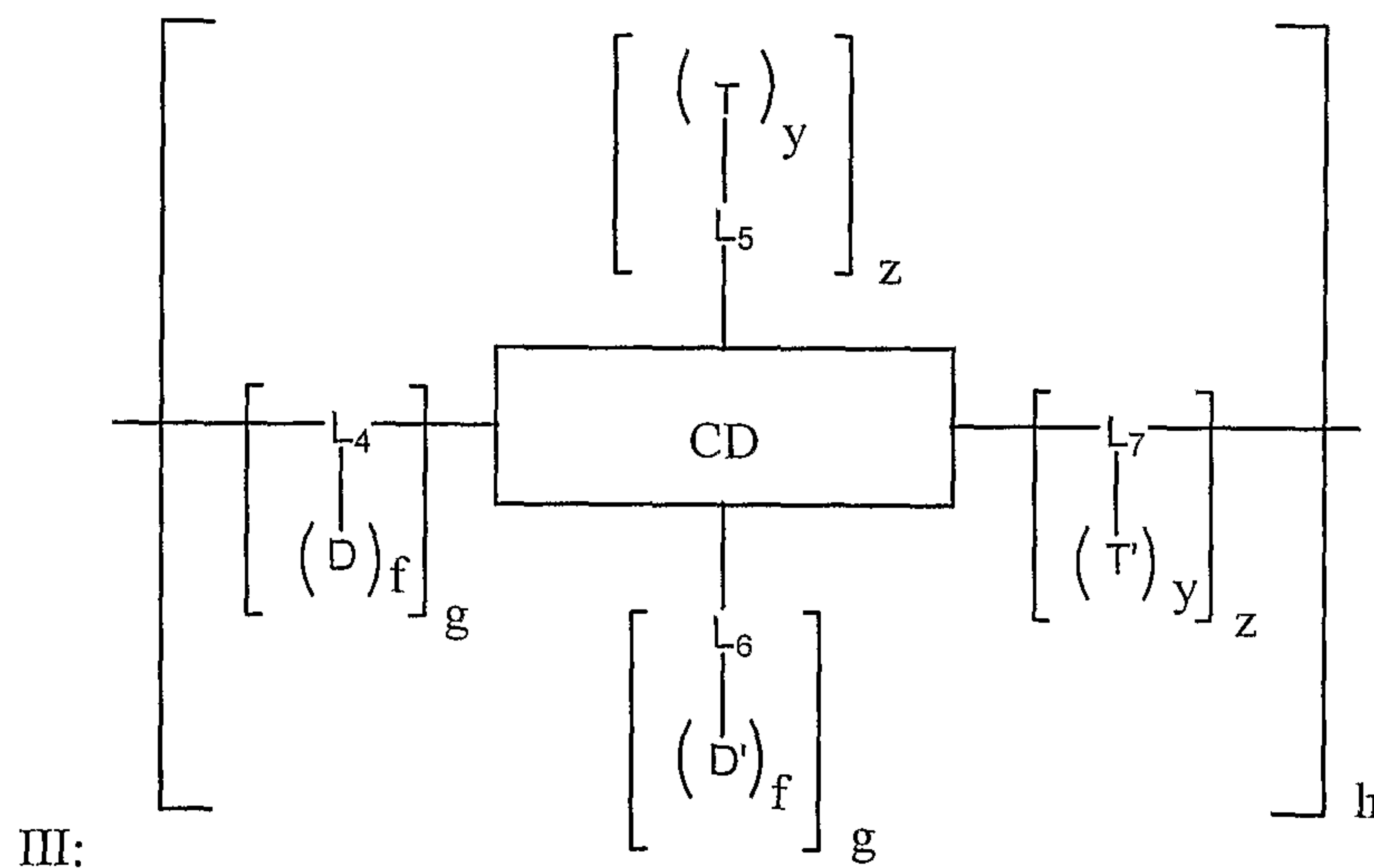

wherein

20 CD represents a cyclic moiety, such as a cyclodextrin moiety, or derivative thereof;

$L_4$ ,  $L_5$ ,  $L_6$ , and  $L_7$ , independently for each occurrence, may be absent or represent a linker group;

D and D', independently for each occurrence, represent the same or different therapeutic agent or prodrugs thereof;

T and T', independently for each occurrence, represent the same or different targeting ligand or precursor thereof;

5 f and y, independently for each occurrence, represent an integer in the range of 1 and 10 (preferably 1 to 8, 1 to 5, or even 1 to 3);

g and z, independently for each occurrence, represent an integer in the range of 0 and 10 (preferably 0 to 8, 0 to 5, 0 to 3, or even 0 to about 2); and

10 h represents an integer in the range of 1 and 30,000 (preferably <25,000, <20,000, <15,000, <10,000, <5,000, <1,000, <500, <100, <50, <25, <10, or even <5),

wherein at least one occurrence (and preferably at least 5, 10, or even at least 20, 50, or 100 occurrences) of g represents an integer greater than 0.

15 In preferred embodiments, L4 and L7 represent linker groups.

In certain embodiments, the underlying polymers are linear cyclodextrin-containing polymers, e.g., the polymer backbone includes cyclodextrin moieties. For example, the polymer may be a water-soluble, linear cyclodextrin polymer produced by providing at least one cyclodextrin derivative modified to bear one reactive site at  
20 each of exactly two positions, and reacting the cyclodextrin derivative with a linker having exactly two reactive moieties capable of forming a covalent bond with the reactive sites under polymerization conditions that promote reaction of the reactive sites with the reactive moieties to form covalent bonds between the linker and the cyclodextrin derivative, whereby a linear polymer comprising alternating units of  
25 cyclodextrin derivatives and linkers is produced. Alternatively the polymer may be a water-soluble, linear cyclodextrin polymer having a linear polymer backbone, which polymer comprises a plurality of substituted or unsubstituted cyclodextrin moieties and linker moieties in the linear polymer backbone, wherein each of the cyclodextrin moieties, other than a cyclodextrin moiety at the terminus of a polymer chain, is  
30 attached to two of said linker moieties, each linker moiety covalently linking two cyclodextrin moieties. In yet another embodiment, the polymer is a water-soluble, linear cyclodextrin polymer comprising a plurality of cyclodextrin moieties



covalently linked together by a plurality of linker moieties, wherein each cyclodextrin moiety, other than a cyclodextrin moiety at the terminus of a polymer chain, is attached to two linker moieties to form a linear cyclodextrin polymer.

The linker group(s) may be an alkylene chain, a polyethylene glycol (PEG) chain, polysuccinic anhydride, poly-L-glutamic acid, poly(ethyleneimine), an oligosaccharide, an amino acid chain, or any other suitable linkage. In certain embodiments, the linker group itself can be stable under physiological conditions, such as an alkylene chain, or it can be cleavable under physiological conditions, such as by an enzyme (e.g., the linkage contains a peptide sequence that is a substrate for a peptidase), or by hydrolysis (e.g., the linkage contains a hydrolyzable group, such as an ester or thioester). The linker groups can be biologically inactive, such as a PEG, polyglycolic acid, or polylactic acid chain, or can be biologically active, such as an oligo- or polypeptide that, when cleaved from the moieties, binds a receptor, deactivates an enzyme, etc. Various oligomeric linker groups that are biologically compatible and/or bioerodible are known in the art, and the selection of the linkage may influence the ultimate properties of the material, such as whether it is durable when implanted, whether it gradually deforms or shrinks after implantation, or whether it gradually degrades and is absorbed by the body. The linker group may be attached to the moieties by any suitable bond or functional group, including carbon-carbon bonds, esters, ethers, amides, amines, carbonates, carbamates, sulfonamides, etc.

In certain embodiments, the linker group(s) of the present invention represent a hydrocarbylene group wherein one or more methylene groups is optionally replaced by a group Y (provided that none of the Y groups are adjacent to each other), wherein each Y, independently for each occurrence, is selected from, substituted or unsubstituted aryl, heteroaryl, cycloalkyl, heterocycloalkyl, or -O-, C(=X) (wherein X is NR<sub>1</sub>, O or S), -OC(O)-, -C(=O)O, -NR<sub>1</sub>-, -NR<sub>1</sub>CO-, -C(O)NR<sub>1</sub>-, -S(O)<sub>n</sub>- (wherein n is 0, 1, or 2), -OC(O)-NR<sub>1</sub>, -NR<sub>1</sub>-C(O)-NR<sub>1</sub>-, -NR<sub>1</sub>-C(NR<sub>1</sub>)-NR<sub>1</sub>-, and -B(OR<sub>1</sub>)-; and R<sub>1</sub>, independently for each occurrence, represents H or a lower alkyl.

In certain embodiments, the linker group represents a derivatized or non-derivatized amino acid. In certain embodiments, linker groups with one or more terminal carboxyl groups may be conjugated to the polymer. In certain  
5  
embodiments, one or more of these terminal carboxyl groups may be capped by covalently attaching them to a therapeutic agent, a targeting moiety, or a cyclodextrin moiety via an (thio)ester or amide bond. In still other embodiments, linker groups with one or more terminal hydroxyl, thiol, or amino groups may be incorporated into the polymer. In preferred embodiments, one or more of these  
10  
terminal hydroxyl groups may be capped by covalently attaching them to a therapeutic agent, a targeting moiety, or a cyclodextrin moiety via an (thio)ester, amide, carbonate, carbamate, thiocarbonate, or thiocarbamate bond. In certain  
embodiments, these (thio)ester, amide, (thio)carbonate or (thio)carbamates bonds may be biohydrolyzable, i.e., capable of being hydrolyzed under biological conditions.

15  
In certain embodiments, the polymers as described above have polydispersities less than about 3, or even less than about 2.

In certain embodiments, the therapeutic agent is a small molecule, a peptide, a protein, or a polymer that has therapeutic function. In certain embodiments, the agent is an anti-cancer (such as camptothecin or related derivatives), anti-fungal,  
20  
anti-bacterial, anti-mycotic, or anti-viral therapeutic. In certain embodiments, the agent is a receptor agonist. In certain embodiments, the agent is a receptor antagonist. In certain embodiments, the therapeutic agent is a protease inhibitor. Furthermore, a polymer of the present invention may contain one kind of therapeutic agent, or may contain more than one kind of therapeutic agent. For instance, two or  
25  
more different cancer drugs, or a cancer drug and an immunosuppressant, or an antibiotic and an anti-inflammatory agent may be grafted on to the polymer via optional linkers. By selecting different linkers for different drugs, the release of each drug may be attenuated to achieve maximal dosage and efficacy.

30  
One embodiment of the present invention provides an improved delivery of certain hydrophobic small molecule therapeutics by covalently conjugating them to cyclodextrin containing polymers. Such conjugation improves the aqueous



solubility and hence the bioavailability of the therapeutic agents. Accordingly, in one embodiment of the invention, the therapeutic agent is a hydrophobic compound with a  $\log P > 0.4$ ,  $> 0.6$ ,  $> 0.8$ ,  $> 1$ ,  $> 2$ ,  $> 3$ ,  $> 4$ , or even  $> 5$ . In other embodiments, a hydrophobic therapeutic agent, such as camptothecin, may be conjugated to another  
5 compound, such as an amino acid, prior to covalently attaching the conjugate on to the polymer. Examples of amino acid derivatized camptothecin molecules are illustrated in Scheme V.

The polymer conjugates of the present invention preferably have molecular weights in the range of 10,000 to 500,000; 30,000 to 200,000; or even 70,000 to  
10 150,000 amu.

In certain embodiments, the cyclodextrin moieties make up at least about 2%, 5% or 10% by weight, up to 20%, 30%, 50% or even 80% of the cyclodextrin-modified polymer by weight. In certain embodiments, the therapeutic agents, or targeting ligands make up at least about 1%, 5%, 10% or 15%, 20%, 25%, 30% or  
15 even 35% of the cyclodextrin-modified polymer by weight. Number-average molecular weight ( $M_n$ ) may also vary widely, but generally fall in the range of about 1,000 to about 500,000 daltons, preferably from about 5000 to about 200,000 daltons and, even more preferably, from about 10,000 to about 100,000. Most preferably,  $M_n$  varies between about 12,000 and 65,000 daltons. In certain other  
20 embodiments,  $M_n$  varies between about 3000 and 150,000 daltons. Within a given sample of a subject polymer, a wide range of molecular weights may be present. For example, molecules within the sample may have molecular weights that differ by a factor of 2, 5, 10, 20, 50, 100, or more, or that differ from the average molecular weight by a factor of 2, 5, 10, 20, 50, 100, or more. Exemplary cyclodextrin  
25 moieties include cyclic structures consisting essentially of from 7 to 9 saccharide moieties, such as cyclodextrin and oxidized cyclodextrin. A cyclodextrin moiety optionally comprises a linker moiety that forms a covalent linkage between the cyclic structure and the polymer backbone, preferably having from 1 to 20 atoms in the chain, such as alkyl chains, including dicarboxylic acid derivatives (such as  
30 glutaric acid derivatives, succinic acid derivatives, and the like), and heteroalkyl chains, such as oligoethylene glycol chains.

Cyclodextrins are cyclic polysaccharides containing naturally occurring D-(+)-glucopyranose units in an  $\alpha$ -(1,4) linkage. The most common cyclodextrins are alpha ( $\alpha$ )-cyclodextrins, beta ( $\beta$ )-cyclodextrins and gamma ( $\gamma$ )-cyclodextrins which contain, respectively six, seven, or eight glucopyranose units. Structurally, the cyclic nature of a cyclodextrin forms a torus or donut-like shape having an inner apolar or hydrophobic cavity, the secondary hydroxyl groups situated on one side of the cyclodextrin torus and the primary hydroxyl groups situated on the other. Thus, using ( $\beta$ )-cyclodextrin as an example, a cyclodextrin is often represented schematically as follows.

10

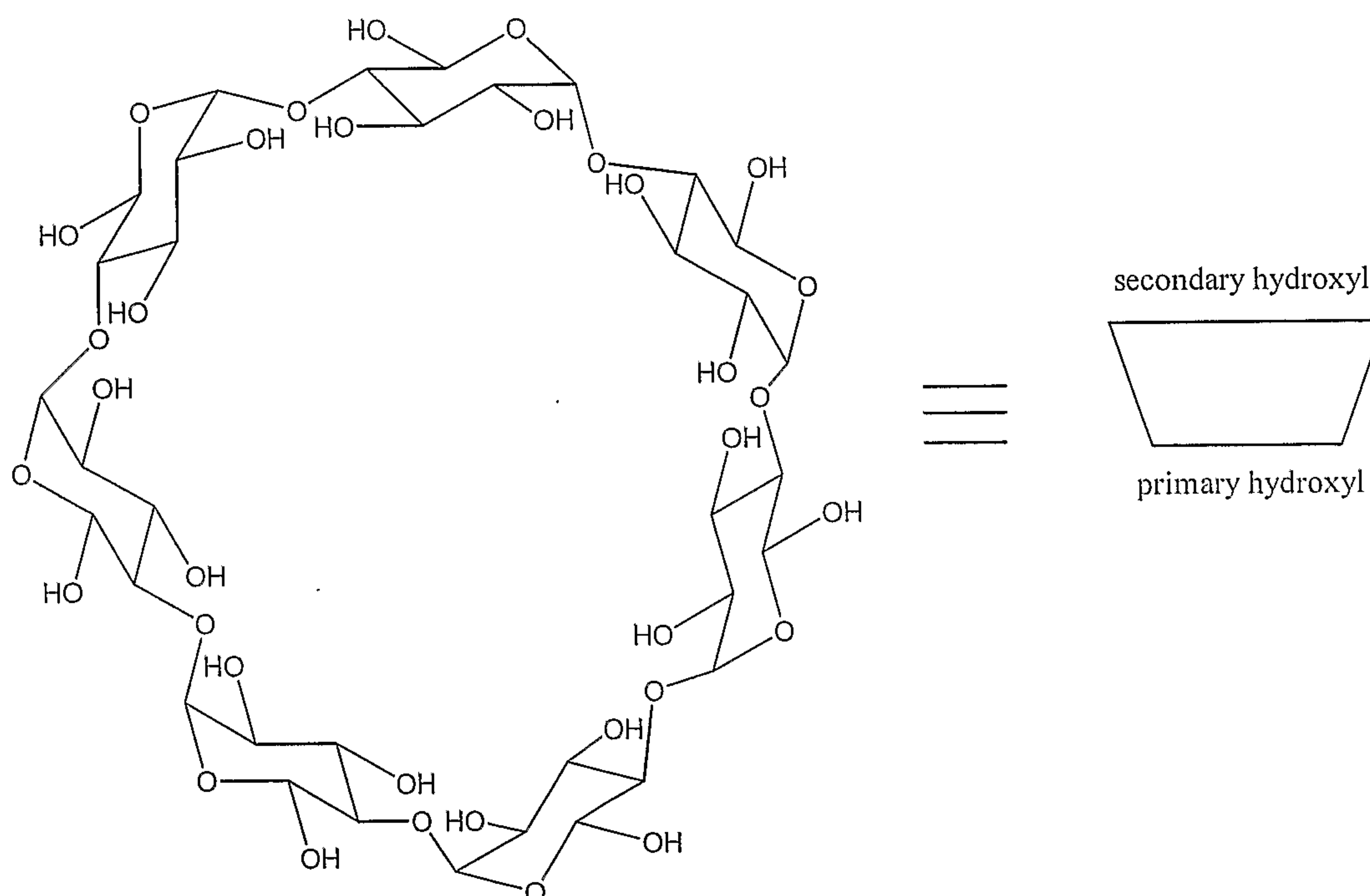

The side on which the secondary hydroxyl groups are located has a wider diameter than the side on which the primary hydroxyl groups are located. The present invention contemplates covalent linkages to cyclodextrin moieties on the primary and/or secondary hydroxyl groups. The hydrophobic nature of the cyclodextrin inner cavity allows for host-guest inclusion complexes of a variety of compounds, e.g., adamantane. (Comprehensive Supramolecular Chemistry, Volume



3, J.L. Atwood et al., eds., Pergamon Press (1996); T. Cserhati, *Analytical Biochemistry*, 225:328-332(1995); Husain et al., *Applied Spectroscopy*, 46:652-658 (1992); FR 2 665 169). Additional methods for modifying polymers are disclosed in Suh, J. and Noh, Y., *Bioorg. Med. Chem. Lett.* **1998**, 8, 1327-1330.

5           In certain embodiments, the present invention contemplates linear, water-soluble, cyclodextrin-containing polymer, wherein a plurality of bioactive moieties are covalently attached to the polymer through attachments that are cleaved under biological conditions to release the bioactive moieties, wherein administration of the polymer to a patient results in release of the bioactive agent over a period of at least  
10   2, 3, 5, 6, 8, 10, 15, 20, 24, 36, 48 or even 72 hours.

          In certain embodiments, the present invention contemplates attenuating the rate of release of the therapeutic agent by introducing various linking groups between the therapeutic agent and/or targeting ligand and the polymer. Thus, in certain embodiments, the polymeric therapeutics of the present invention are  
15   compositions for controlled delivery of therapeutic agents. One skilled in the art would also recognize that by labeling the therapeutic agent and/or targeting ligand with radionuclei, or by forming complexes of NMR active nuclei, e.g., technetium, gadolinium, or dysprosium, the polymers of the present invention can achieve a dual diagnostic/therapeutic utility.

20           In other embodiments, the polymeric compounds stabilize the bioactive form of a therapeutic agent which exists in equilibrium between an active and inactive form. For instance, conjugating the therapeutic agent to the polymers of the present invention may shift the equilibrium between two tautomeric forms of the agent to the bioactive tautomer. In other embodiment, the polymeric compounds may  
25   attenuate the equilibrium between lactonic and acid forms of a therapeutic agent.

          One method to determine molecular weight is by gel permeation chromatography ("GPC"), e.g., mixed bed columns, CH<sub>2</sub>Cl<sub>2</sub> solvent, light scattering detector, and off-line dn/dc. Other methods are known in the art.

In other embodiments, the polymer conjugate of the invention may be a flexible or flowable material. When the polymer used is itself flowable, the polymer composition of the invention, even when viscous, need not include a biocompatible solvent to be flowable, although trace or residual amounts of biocompatible solvents  
5 may still be present.

While it is possible that the biodegradable polymer or the biologically active agent may be dissolved in a small quantity of a solvent that is non-toxic to more efficiently produce an amorphous, monolithic distribution or a fine dispersion of the biologically active agent in the flexible or flowable composition, it is an advantage  
10 of the invention that, in a preferred embodiment, no solvent is needed to form a flowable composition. Moreover, the use of solvents is preferably avoided because, once a polymer composition containing solvent is placed totally or partially within the body, the solvent dissipates or diffuses away from the polymer and must be processed and eliminated by the body, placing an extra burden on the body's  
15 clearance ability at a time when the illness (and/or other treatments for the illness) may have already deleteriously affected it.

However, when a solvent is used to facilitate mixing or to maintain the flowability of the polymer conjugate of the invention, it should be non-toxic, otherwise biocompatible, and should be used in relatively small amounts. Solvents  
20 that are toxic should not be used in any material to be placed even partially within a living body. Such a solvent also must not cause substantial tissue irritation or necrosis at the site of administration.

Examples of suitable biocompatible solvents, when used, include N-methyl-2-pyrrolidone, 2-pyrrolidone, ethanol, propylene glycol, acetone, methyl acetate,  
25 ethyl acetate, methyl ethyl ketone, dimethylformamide, dimethylsulfoxide, tetrahydrofuran, caprolactam, oleic acid, or 1-dodecylazacycloheptanone. Preferred solvents include N-methylpyrrolidone, 2-pyrrolidone, dimethylsulfoxide, and acetone because of their solvating ability and their biocompatibility.

In certain embodiments, the subject polymer conjugates are soluble in one or  
30 more common organic solvents for ease of fabrication and processing. Common



organic solvents include such solvents as chloroform, dichloromethane, dichloroethane, 2-butanone, butyl acetate, ethyl butyrate, acetone, ethyl acetate, dimethylacetamide, N-methylpyrrolidone, dimethylformamide, and dimethylsulfoxide.

5 One aspect of the present invention contemplates attaching a hydrophobic therapeutic agent such as (*S*)-20-camptothecin to linear or branched cyclodextrin-containing polymers for better delivery of the drug. (*S*)-20-camptothecin (CPT), an alkaloid isolated from *Camptithec**a accuminata* in the late 1950's, was found to exhibit anticancer activity by inhibiting the action of topoisomerase I during the S-  
10 phase of the cell cycle. Its application in human cancer treatment, however, is limited due to several factors, especially its undesirable interactions with human serum albumin, instability of the bioactive lactone form, and poor aqueous solubility. In order to circumvent this problem, many CPT analogs have been developed to improve lactone stability and aqueous solubility. Topotecan and  
15 irinotecan are analogs of CPT that have already been approved by FDA for human cancer treatment. The present invention discloses various types of linear, branched, or grafted cyclodextrin-containing polymers wherein (*S*)-20-camptothecin is covalently bound to the polymer. In certain embodiments, the drug is covalently linked via a biohydrolyzable bond selected from an ester, amide, carbamates, or  
20 carbonate.

An exemplary synthetic scheme for covalently bonding a derivatized CD to 20(*S*)-camptothecin is shown in Scheme I.

Scheme I

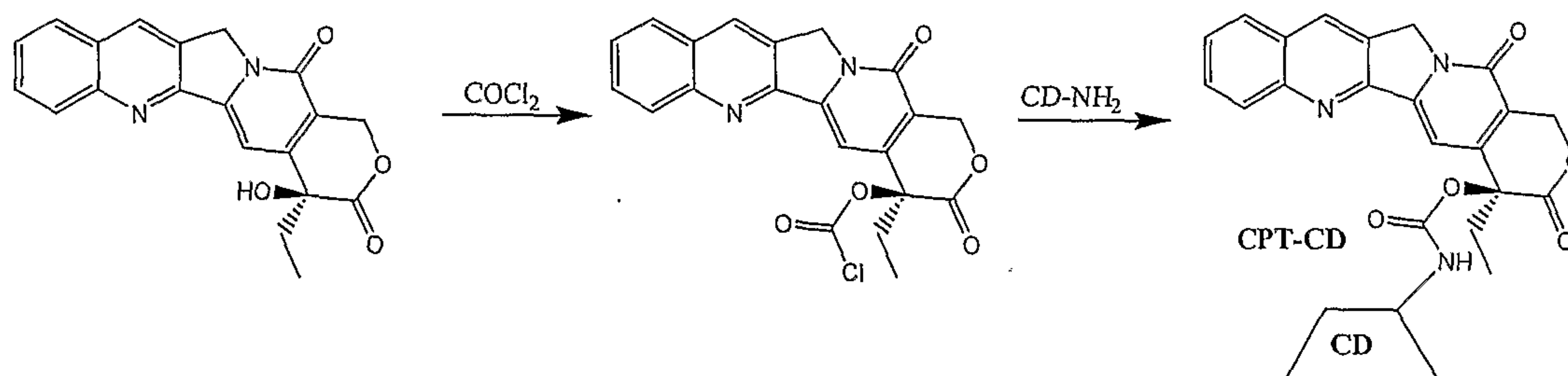

25

Without intending to limit the scope of the invention, a general strategy for synthesizing linear, branched or grafted cyclodextrin-containing polymers (CD Polymer) for loading a therapeutic agent such as camptothecin, and an optional targeting ligand is shown in Scheme II.

## 5 Scheme II

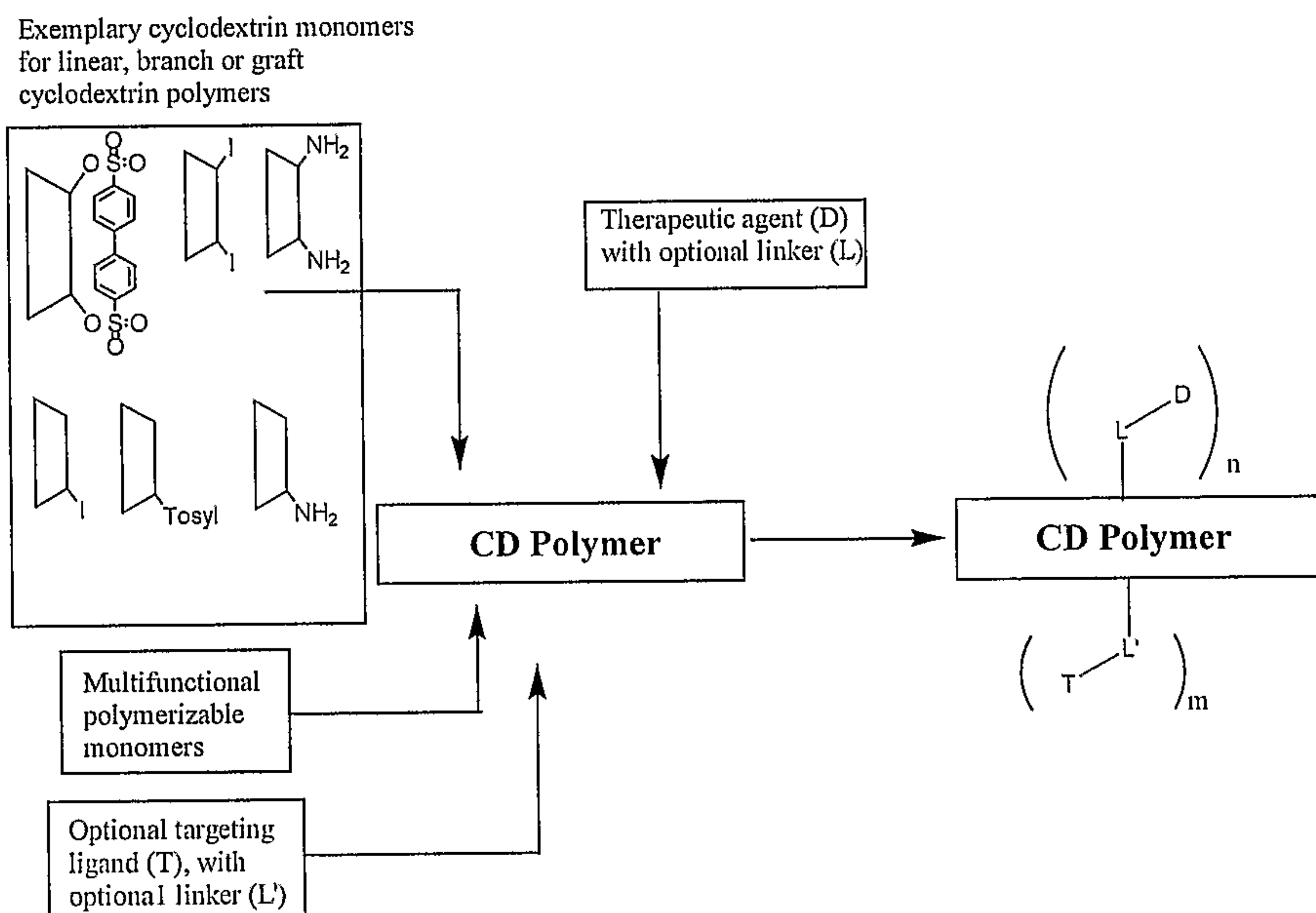

To illustrate further, without intending to be limiting, comonomer A precursors, cyclodextrin moieties, therapeutic agents, and/or targeting ligands may be assembled as shown in Schemes IIa-IIb. Note that in schemes IIa-b, in any given reaction there may be more than one comonomer A precursor, cyclodextrin moiety, therapeutic agent or targeting ligand that is of the same type or different. Furthermore, prior to polymerization, one or more comonomer A precursor, cyclodextrin moiety, therapeutic agent or targeting ligand may be covalently linked with each other in one or more separate step.

Scheme IIa: General scheme for graft polymers. The comonomer A precursor, cyclodextrin moiety, therapeutic agent and targeting ligand are as defined above. Furthermore, one skilled in the art may choose from a variety of reactive groups, e.g., hydroxyls, carboxyls, halides, amines, and activated ethenes, ethynes, or aromatic groups in order to achieve polymerization. For further examples of



reactive groups are disclosed in Advanced Organic Chemistry: Reactions, Mechanisms, and Structure, 5th Edition, 2000.

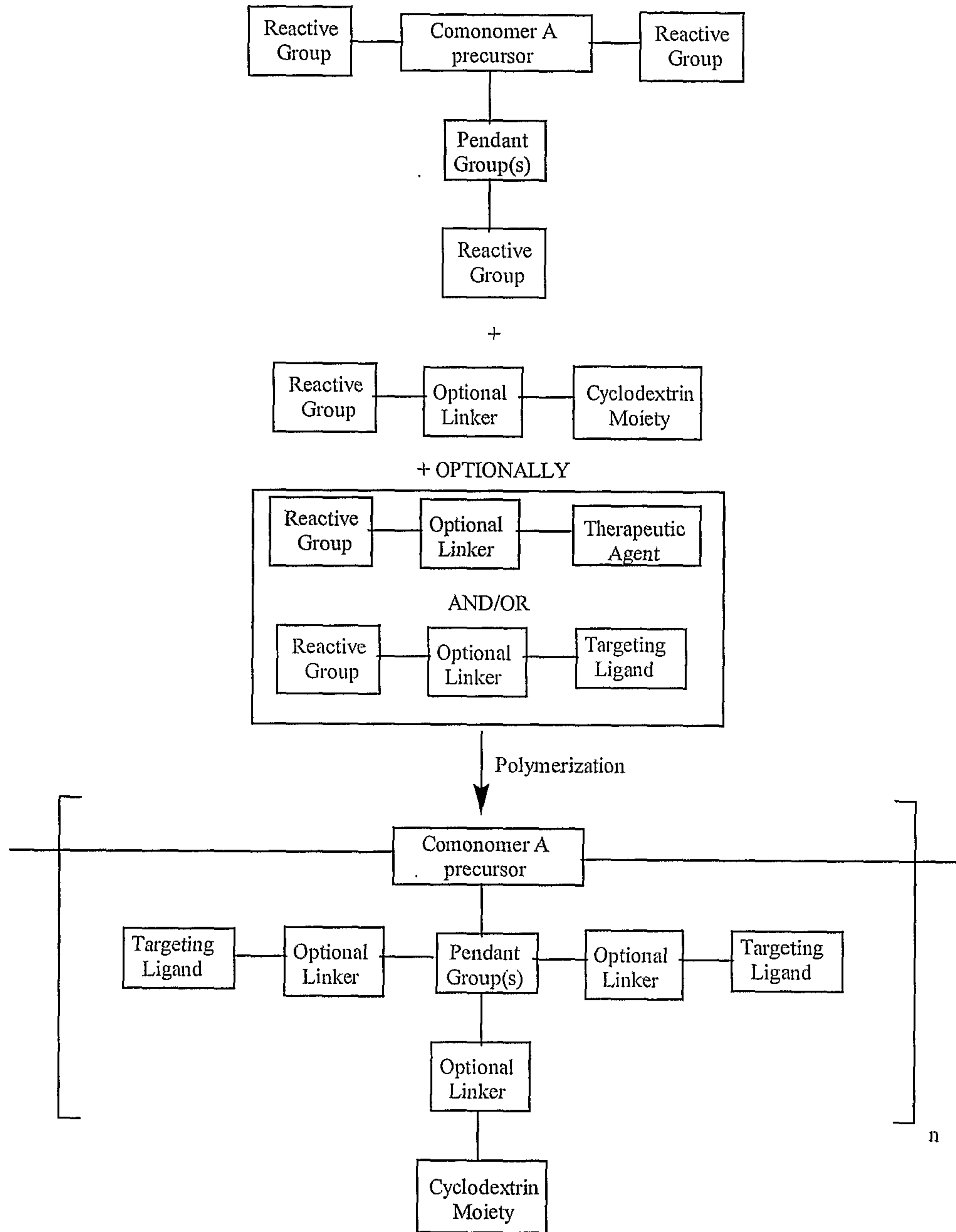

5

Scheme IIb: General scheme of preparing linear cyclodextrin-containing polymers. One skilled in the art would recognize that by choosing a comonomer A precursor that has multiple reactive groups polymer branching can be achieved.

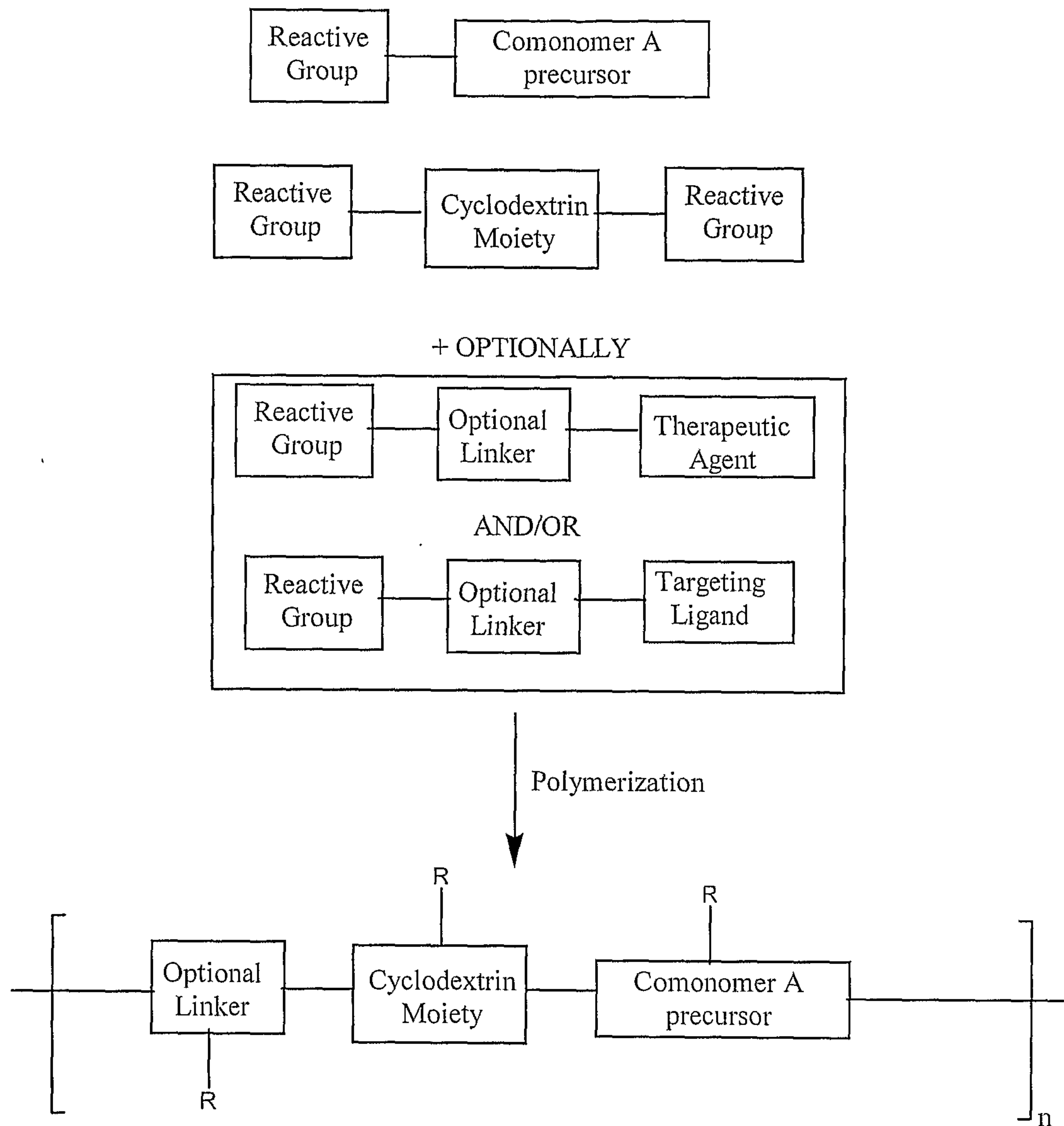

5 Examples for different ways of synthesizing linear cyclodextrin-CPT polymers are shown in Schemes III-VIII.

Scheme III



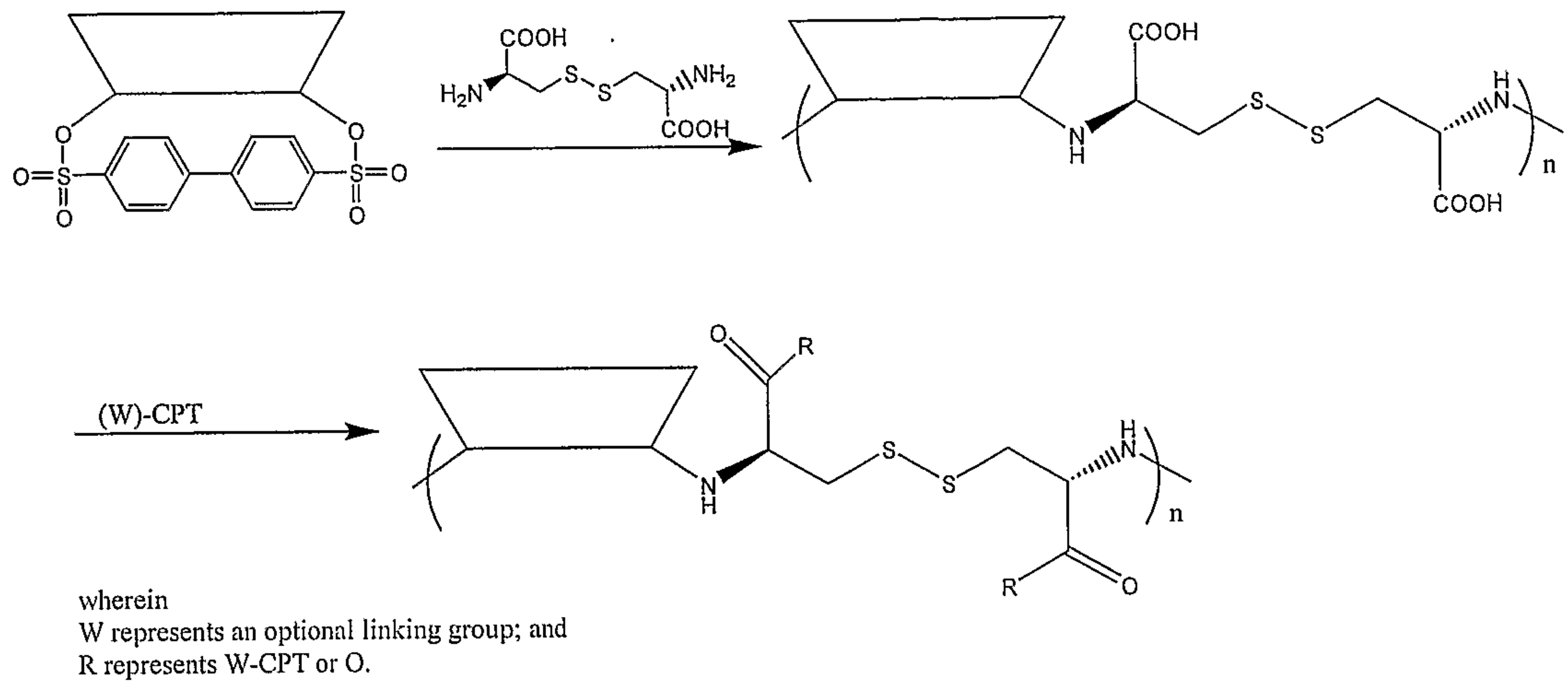

## Scheme IV

5

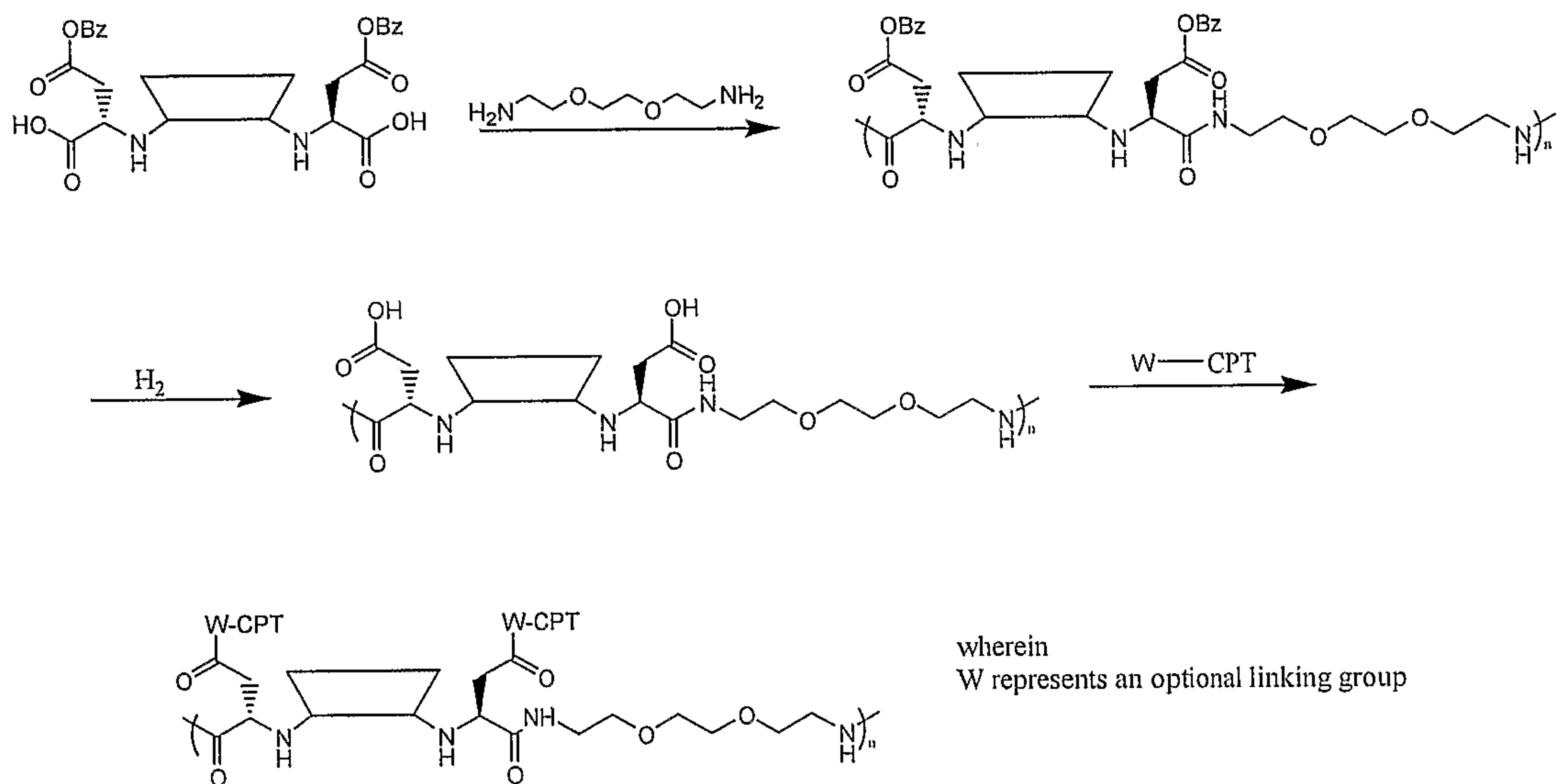

## Scheme V

10

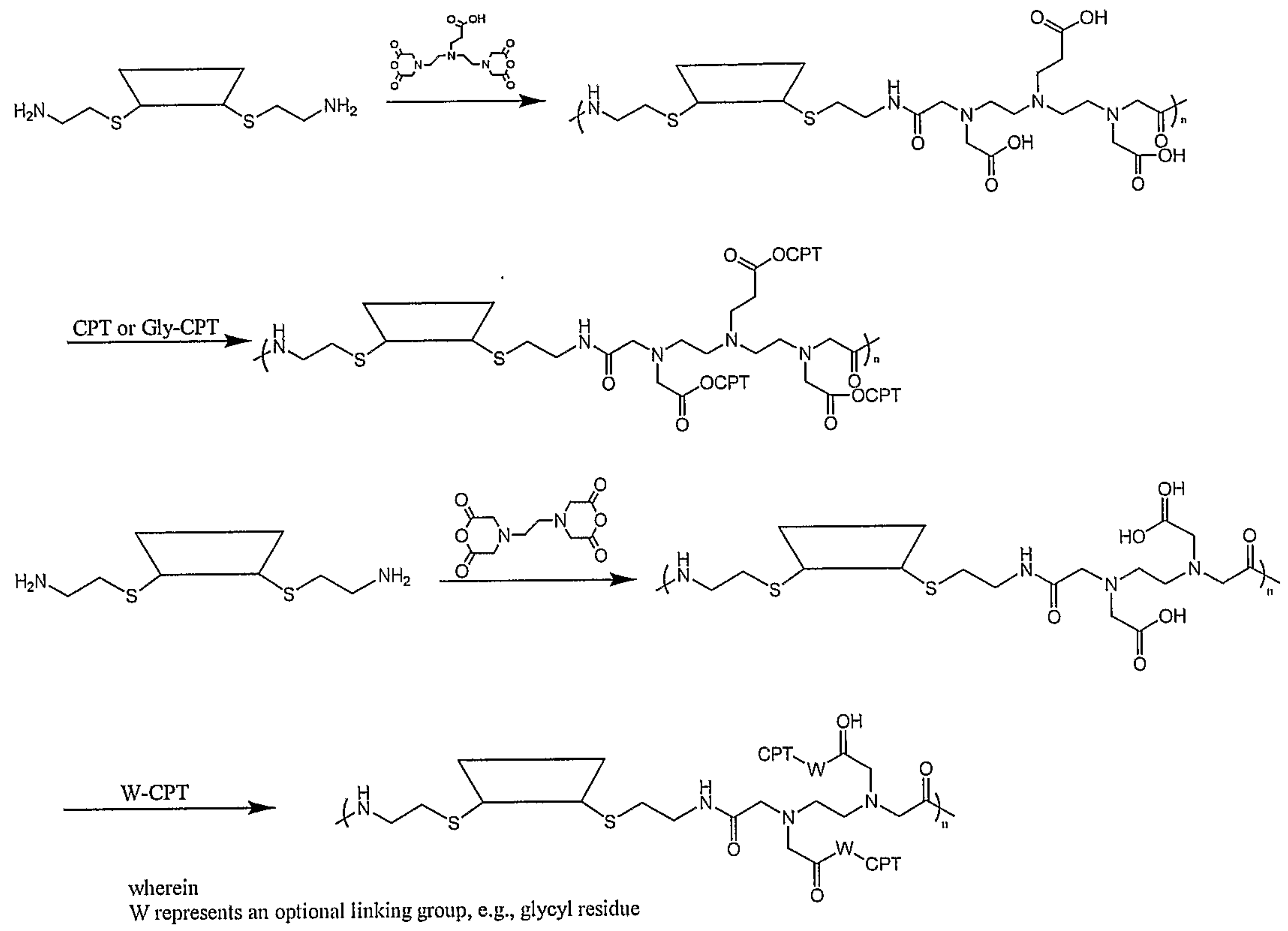

Scheme VI



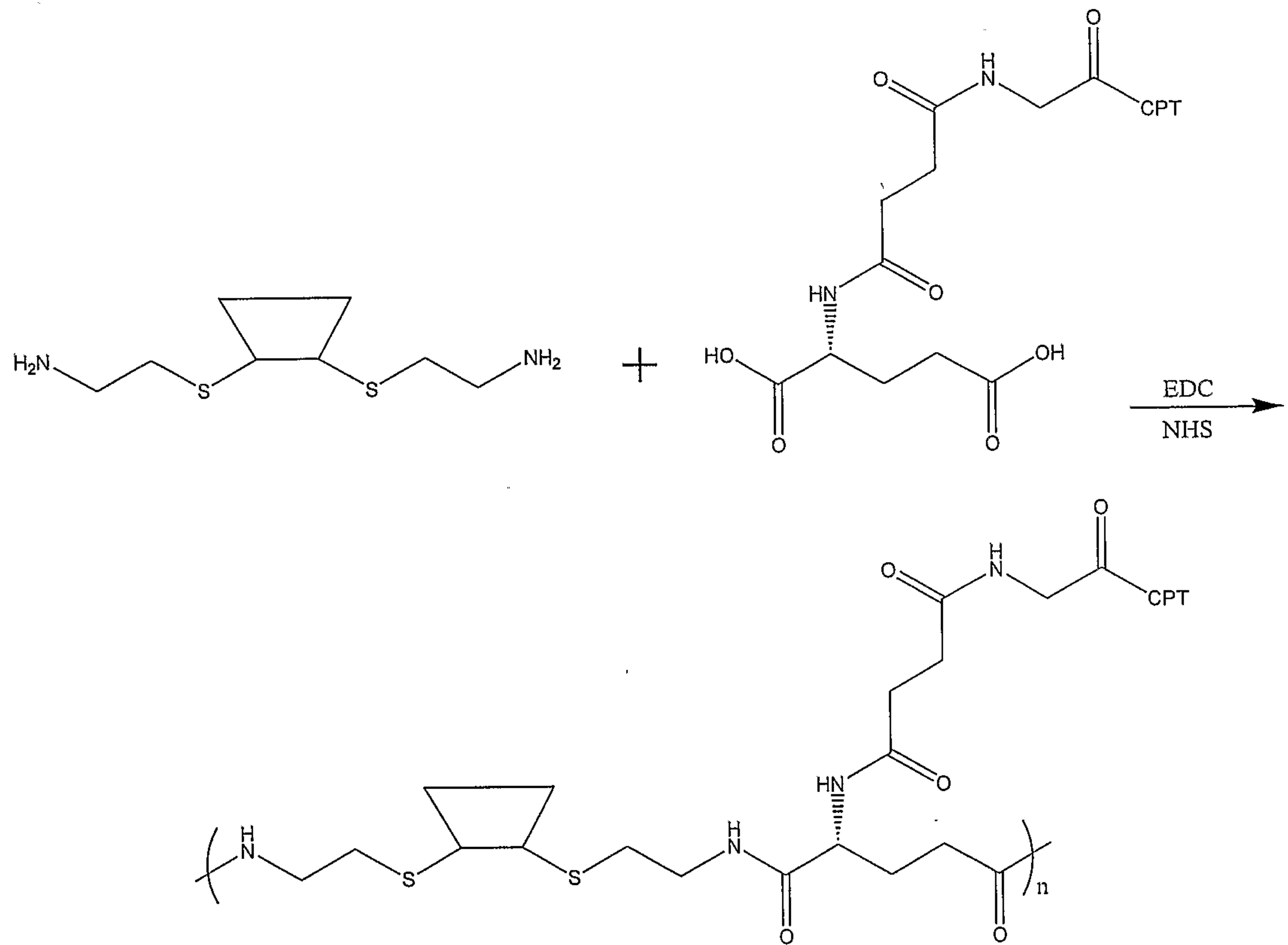

Scheme VII

5

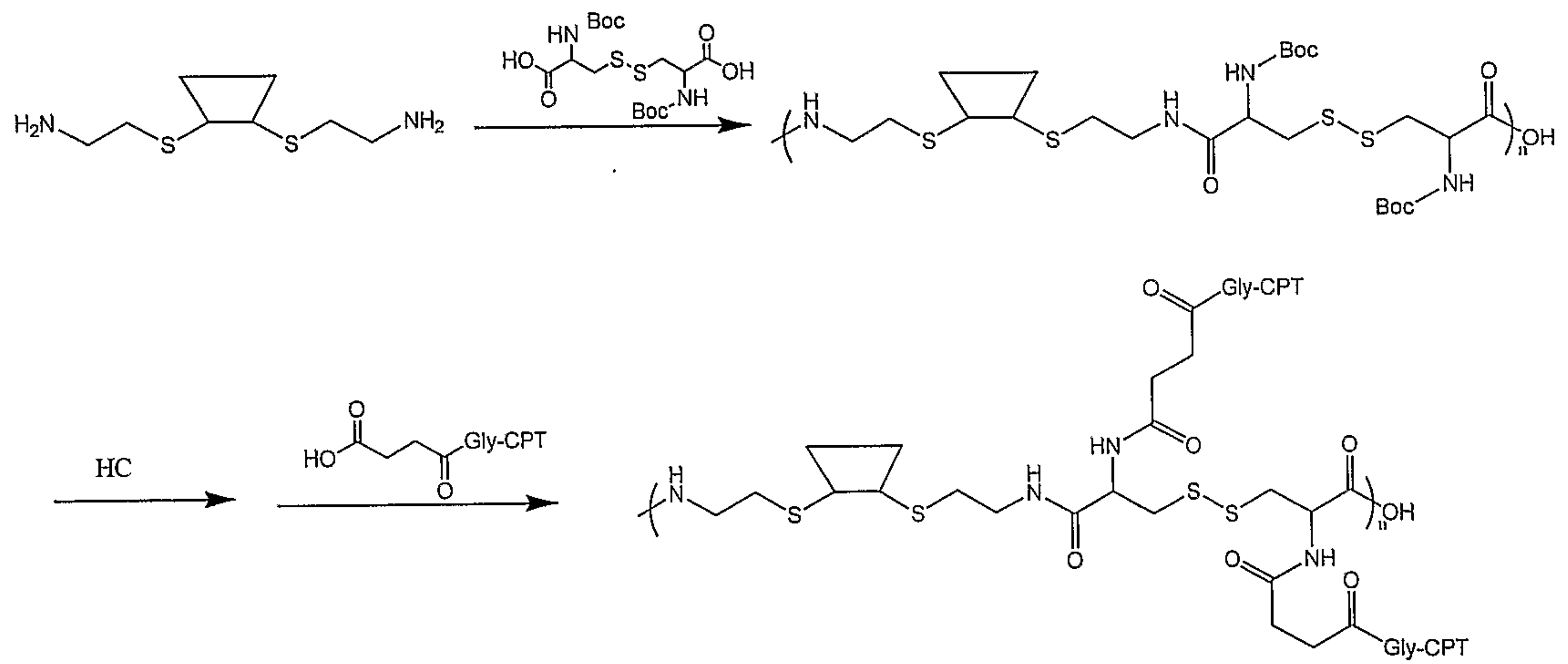

Scheme VIII

10

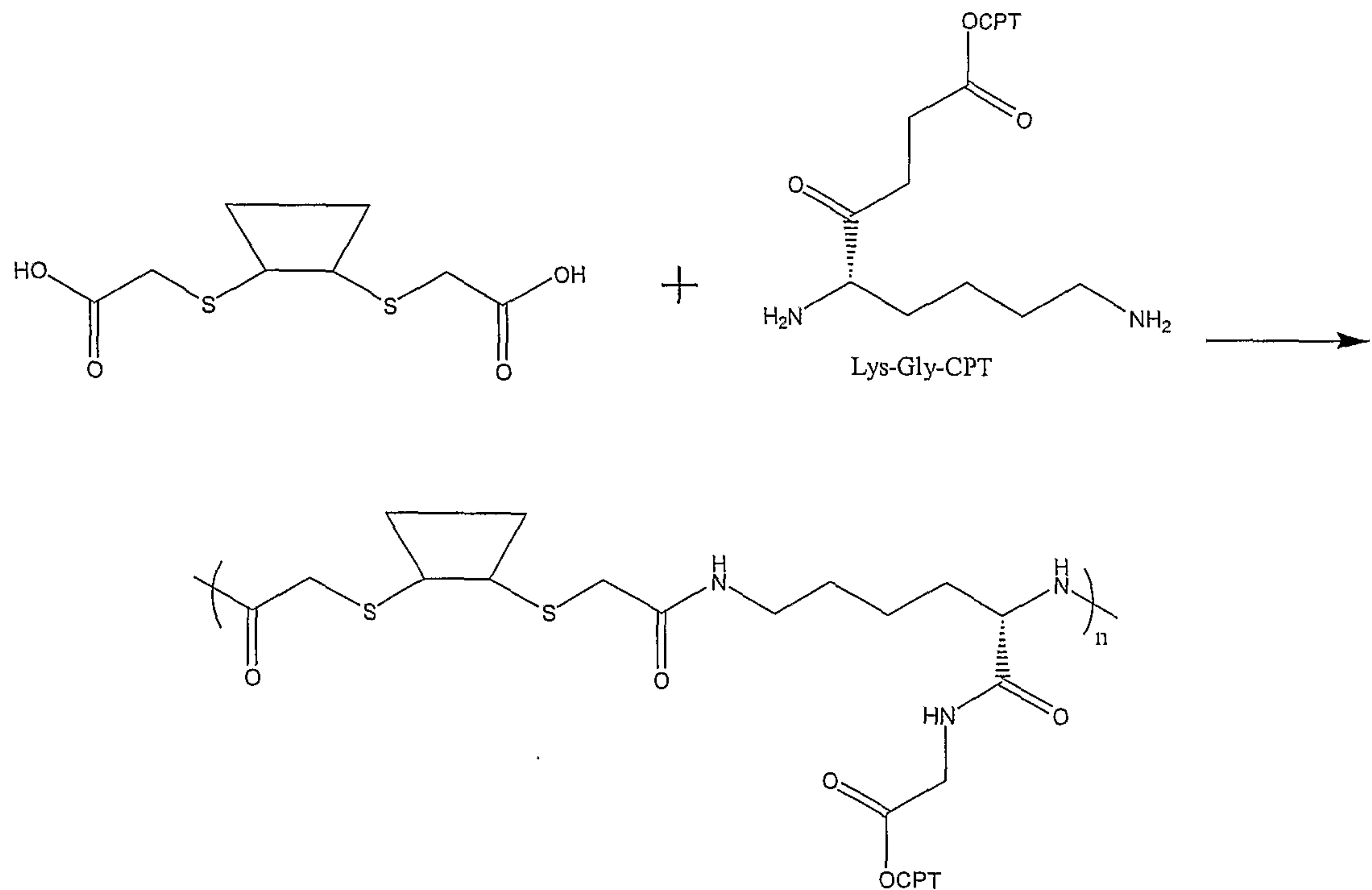

5 Examples for grafting cyclodextrins on to side-chains of CPT-containing  
 polymers subunits are shown in Schemes IX-XII. Each subunit may repeat any  
 number of times, and one subunit may occur with substantially the same frequency,  
 more often, or less often than another subunit, such that both subunits may be  
 present in approximately the same amount, or in differing amounts, which may  
 differ slightly or be highly disparate, e.g., one subunit is present nearly to the  
 10 exclusion of the other.

In certain instances, the polymers are random copolymers, in which the  
 different subunits and/or other monomeric units are distributed randomly throughout  
 the polymer chain. Thus, where the formula X<sub>m</sub>-Y<sub>n</sub>-Z<sub>o</sub> appears, wherein X, Y and Z  
 are polymer subunits, these subunits may be randomly interspersed throughout the  
 15 polymer backbone. In part, the term "random" is intended to refer to the situation in  
 which the particular distribution or incorporation of monomeric units in a polymer  
 that has more than one type of monomeric units is not directed or controlled directly  
 by the synthetic protocol, but instead results from features inherent to the polymer



system, such as the reactivity, amounts of subunits and other characteristics of the synthetic reaction or other methods of manufacture, processing, or treatment.

Scheme IX

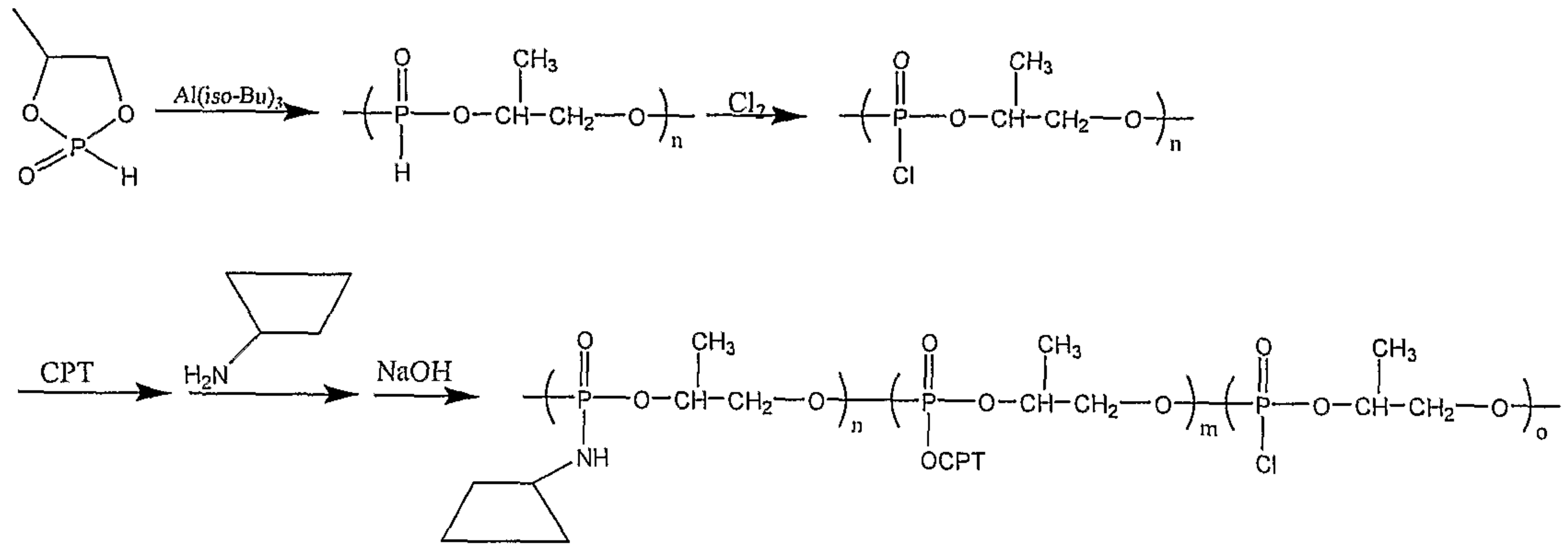

Scheme X

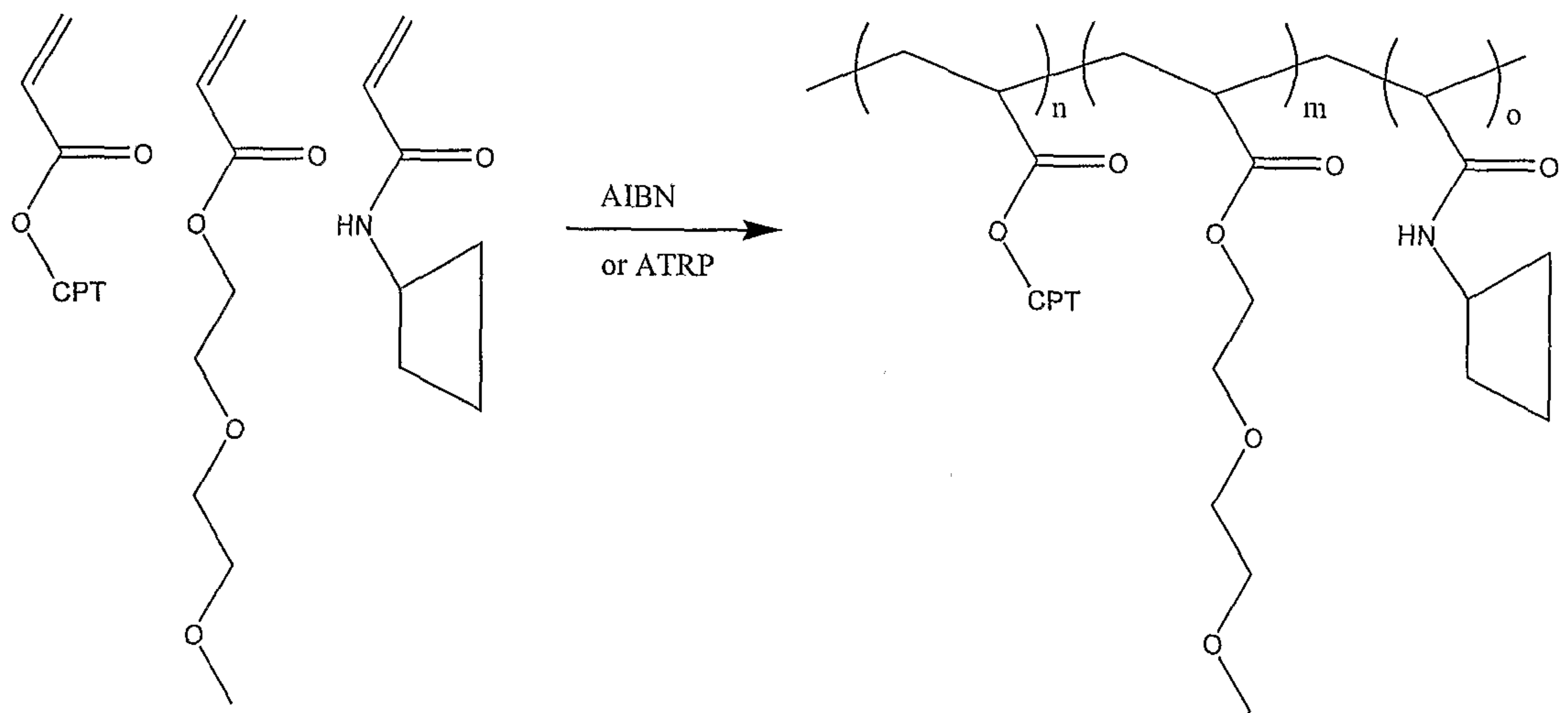

Scheme XI

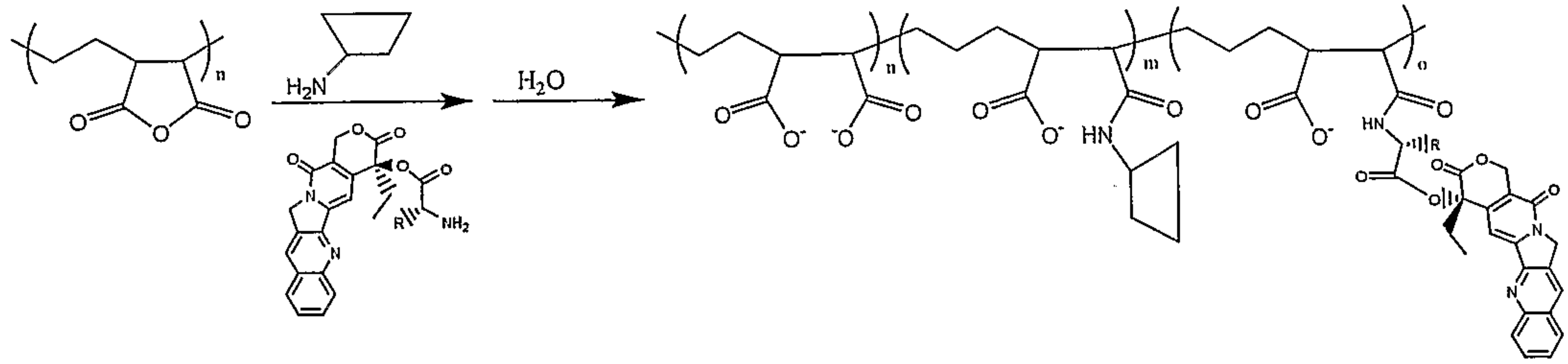

Scheme XII

5

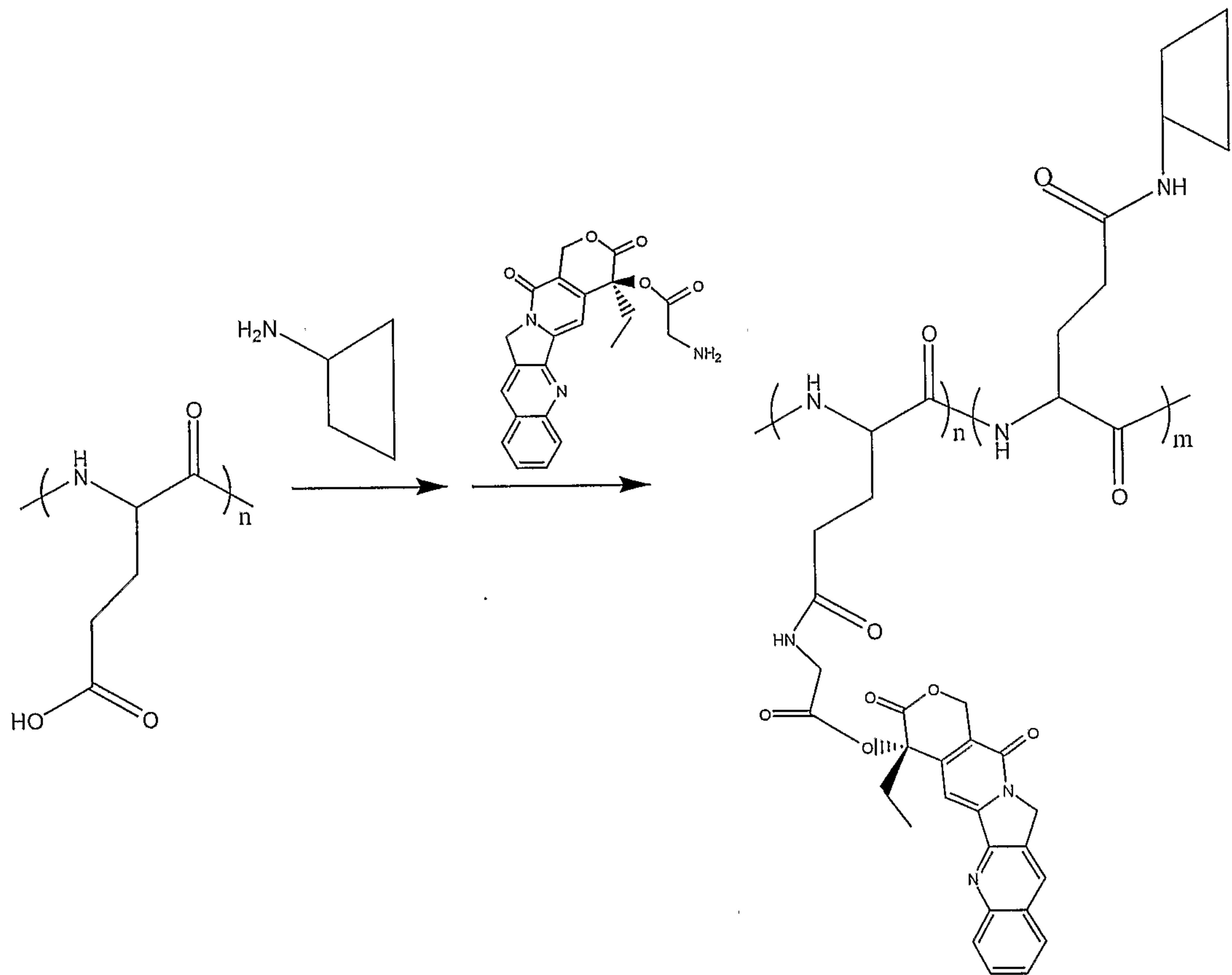

The present invention further contemplates CD-polymers synthesized using  
 10 CD-biscysteine monomer and a di-NHS ester such as PEG-DiSPA or PEG-BTC as  
 shown in Schemes XIII-XIV.



## Scheme XIII

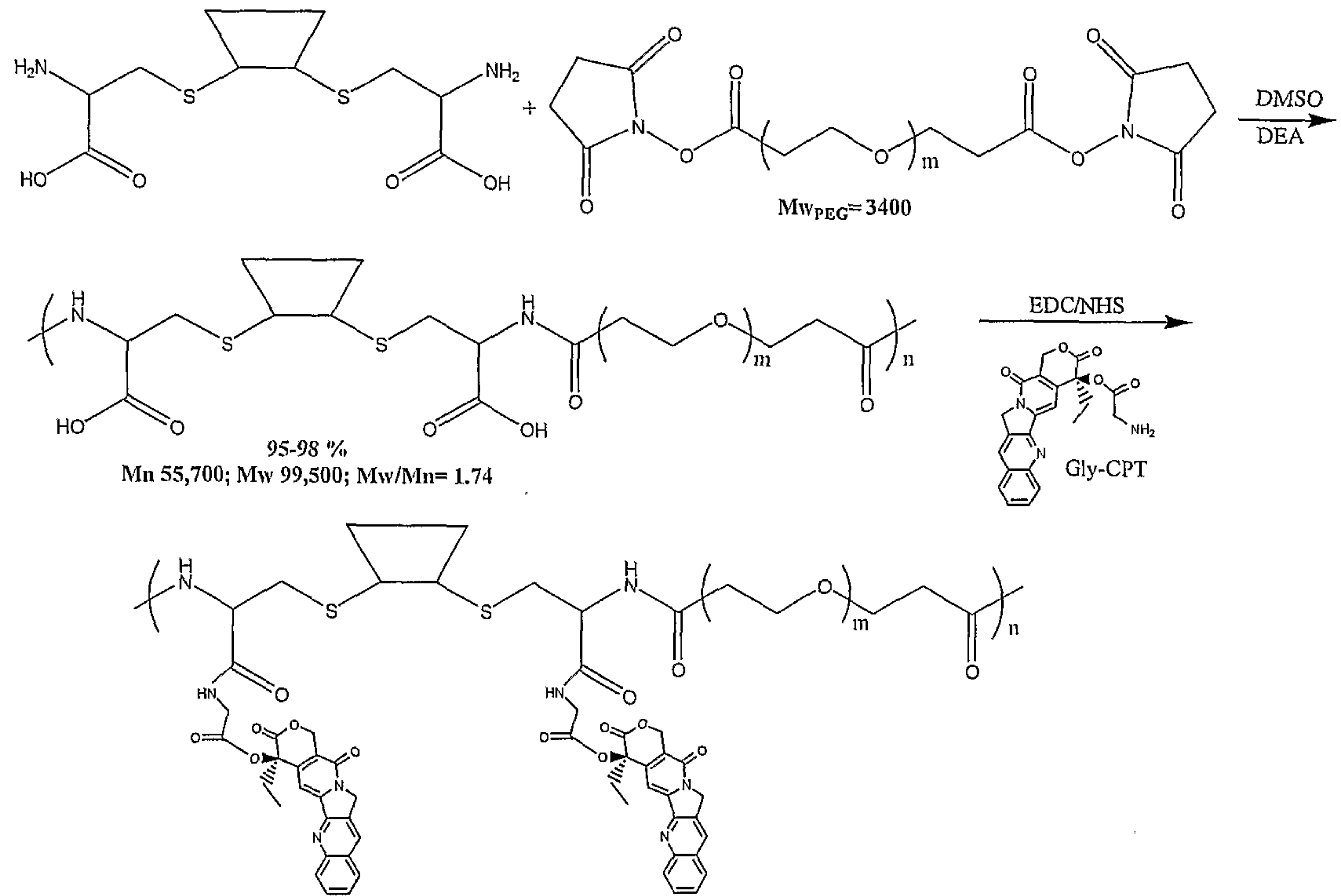

## 5 Scheme XIV

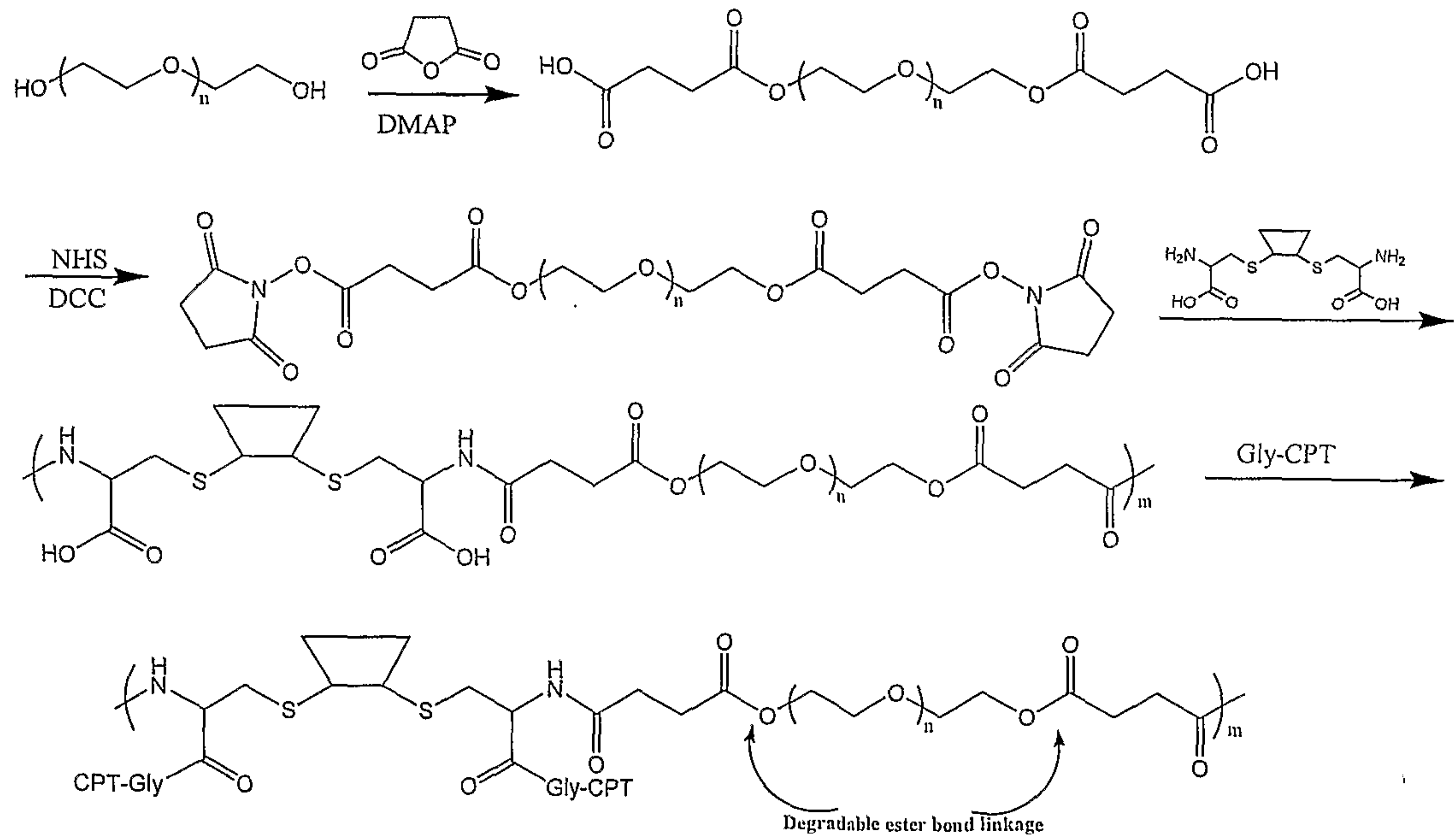

In certain embodiments, the present invention discloses several strategies to increase drug loading as shown in Figure 1.

(b) *Targeting Ligand*

5

As mentioned above, one aspect of the present invention contemplates attaching a therapeutic agent to the polymer conjugates described herein.

In certain embodiments, the polymer conjugate further comprises a targeting ligand. Thus in certain embodiments, a receptor, cell, and/or tissue-targeting ligand, or a precursor thereof is coupled to a polymer conjugate. As used herein the term "targeting ligand" refers to any material or substance which may promote targeting of receptors, cells, and/or tissues in vivo or in vitro with the compositions of the present invention. The targeting ligand may be synthetic, semi-synthetic, or naturally-occurring. Materials or substances which may serve as targeting ligands include, for example, proteins, including antibodies, antibody fragments, hormones, hormone analogues, glycoproteins and lectins, peptides, polypeptides, amino acids, sugars, saccharides, including monosaccharides and polysaccharides, carbohydrates, small molecules, vitamins, steroids, steroid analogs, hormones, cofactors, bioactive agents, and genetic material, including nucleosides, nucleotides, nucleotide acid constructs and polynucleotides. As used herein, the term "precursor" to a targeting ligand refers to any material or substance which may be converted to a targeting ligand. Such conversion may involve, for example, anchoring a precursor to a targeting ligand. Exemplary targeting precursor moieties include maleimide groups, disulfide groups, such as ortho-pyridyl disulfide, vinylsulfone groups, azide groups, and  $\alpha$ -iodo acetyl groups. The attachment of the targeting ligand or precursor thereof to the polymer may be accomplished in various ways including but not limited to chelation, covalent attachment, or formation of host-guest complexes. In certain embodiments, an optional linker group may be present between the targeting ligand or precursor thereof and the polymer, wherein the linker group is attached to the polymer via chelation, covalent attachment or form host guest complexes. For example, the one terminal end of a linker group may be attached to the targeting

10  
15  
20  
25  
30



ligand while the other may be attached to an adamantane group, or other such hydrophobic moiety, which forms a host guest complex with a cyclodextrin moiety. Thus the targeting ligand may be attached to a grafted cyclodextrin moiety, to a cyclodextrin moiety within the polymeric chain, or to the polymeric chain itself.

5 The number of targeting ligands per polymeric chain may vary according to various factors including but not limited to the identity of the therapeutic agent, nature of the disease, type of polymer chain. Structures of possible linker groups are the same as linker groups defined elsewhere in this application.

10 (c) Pharmaceutical Compositions, Formulations and Dosages

In part, a biocompatible polymer composition of the present invention includes a biocompatible and optionally biodegradable polymer, such as one having the recurring monomeric units shown in one of the foregoing formulas, optionally including any other biocompatible and optionally biodegradable polymer mentioned  
15 above or known in the art. In certain embodiments, the compositions are non-pyrogenic, e.g., do not trigger elevation of a patient's body temperature by more than a clinically acceptable amount.

The subject compositions may contain a "drug", "therapeutic agent," "medicament," or "bioactive substance," which are biologically, physiologically, or  
20 pharmacologically active substances that act locally or systemically in the human or animal body. For example, a subject composition may include any of the other compounds discussed above.

Various forms of the medicaments or biologically active materials may be used which are capable of being released from the polymer matrix into adjacent  
25 tissues or fluids. They may be hydrophobic molecules, neutral molecules, polar molecules, or molecular complexes capable of hydrogen bonding. They may be in the form of ethers, esters, amides and the like, including prodrugs which are biologically activated when injected into the human or animal body, e.g., by cleavage of an ester or amide. A therapeutic agent in a subject composition may  
30 vary widely with the purpose for the composition.

Plasticizers and stabilizing agents known in the art may be incorporated in polymers of the present invention. In certain embodiments, additives such as plasticizers and stabilizing agents are selected for their biocompatibility. In certain embodiments, the additives are lung surfactants, such as 1,2-  
5 dipalmitoylphosphatidylcholine (DPPC) and L- $\alpha$ -phosphatidylcholine (PC).

A composition of this invention may further contain one or more adjuvant substances, such as fillers, thickening agents or the like. In other embodiments, materials that serve as adjuvants may be associated with the polymer matrix. Such additional materials may affect the characteristics of the polymer matrix that results.

10 For example, fillers, such as bovine serum albumin (BSA) or mouse serum albumin (MSA), may be associated with the polymer matrix. In certain embodiments, the amount of filler may range from about 0.1 to about 50% or more by weight of the polymer matrix, or about 2.5, 5, 10, 25, or 40 percent. Incorporation of such fillers may affect the biodegradation of the polymeric material  
15 and/or the sustained release rate of any encapsulated substance. Other fillers known to those of skill in the art, such as carbohydrates, sugars, starches, saccharides, celluloses and polysaccharides, including mannitose and sucrose, may be used in certain embodiments of the present invention.

In other embodiments, spheronization enhancers facilitate the production of  
20 subject polymeric matrices that are generally spherical in shape. Substances such as zein, microcrystalline cellulose or microcrystalline cellulose co-processed with sodium carboxymethyl cellulose may confer plasticity to the subject compositions as well as implant strength and integrity. In particular embodiments, during spheronization, extrudates that are rigid, but not plastic, result in the formation of  
25 dumbbell shaped implants and/or a high proportion of fines, and extrudates that are plastic, but not rigid, tend to agglomerate and form excessively large implants. In such embodiments, a balance between rigidity and plasticity is desirable. The percent of spheronization enhancer in a formulation typically range from 10 to 90% (w/w).



In certain embodiments, a subject composition includes an excipient. A particular excipient may be selected based on its melting point, solubility in a selected solvent (e.g., a solvent that dissolves the polymer and/or the therapeutic agent), and the resulting characteristics of the microparticles.

5           Excipients may comprise a few percent, about 5%, 10%, 15%, 20%, 25%, 30%, 40%, 50%, or higher percentage of the subject compositions.

          Buffers, acids and bases may be incorporated in the subject compositions to adjust their pH. Agents to increase the diffusion distance of agents released from the polymer matrix may also be included.

10           Disintegrants are substances that, in the presence of liquid, promote the disruption of the subject compositions. Disintegrants are most often used in implants, in which the function of the disintegrant is to counteract or neutralize the effect of any binding materials used in the subject formulation. In general, the mechanism of disintegration involves moisture absorption and swelling by an  
15   insoluble material.

          Examples of disintegrants include croscarmellose sodium and crospovidone which, in certain embodiments, may be incorporated into the polymeric matrices in the range of about 1-20% of total matrix weight. In other cases, soluble fillers such as sugars (mannitol and lactose) may also be added to facilitate disintegration of  
20   implants.

          Other materials may be used to advantage or to control the desired release rate of a therapeutic agent for a particular treatment protocol. For example, if the sustained release is too slow for a particular application, a pore-forming agent may be added to generate additional pores in the matrix. Any biocompatible water-  
25   soluble material may be used as the pore-forming agent. They may be capable of dissolving, diffusing or dispersing out of the formed polymer system whereupon pores and microporous channels are generated in the system. The amount of pore-forming agent (and size of dispersed particles of such pore-forming agent, if

appropriate) within the composition should affect the size and number of the pores in the polymer system.

Pore-forming agents include any pharmaceutically acceptable organic or inorganic substance that is substantially miscible in water and body fluids and will  
5 dissipate from the forming and formed matrix into aqueous medium or body fluids or water-immiscible substances that rapidly degrade to water-soluble substances.

Suitable pore-forming agents include, for example, sugars such as sucrose and dextrose, salts such as sodium chloride and sodium carbonate, and polymers such as hydroxypropylcellulose, carboxymethylcellulose, polyethylene glycol, and  
10 PVP. The size and extent of the pores may be varied over a wide range by changing the molecular weight and percentage of pore-forming agent incorporated into the polymer system.

The charge, lipophilicity or hydrophilicity of any subject polymeric matrix may be modified by attaching in some fashion an appropriate compound to the  
15 surface of the matrix. For example, surfactants may be used to enhance wettability of poorly soluble or hydrophobic compositions. Examples of suitable surfactants include dextran, polysorbates and sodium lauryl sulfate. In general, surfactants are used in low concentrations, generally less than about 5%.

Binders are adhesive materials that may be incorporated in polymeric  
20 formulations to bind and maintain matrix integrity. Binders may be added as dry powder or as solution. Sugars and natural and synthetic polymers may act as binders.

Materials added specifically as binders are generally included in the range of about 0.5%-15% w/w of the matrix formulation. Certain materials, such as  
25 microcrystalline cellulose, also used as a spheronization enhancer, also have additional binding properties.

Various coatings may be applied to modify the properties of the matrices.



Three exemplary types of coatings are seal, gloss and enteric coatings. Other types of coatings having various dissolution or erosion properties may be used to further modify subject matrices behavior, and such coatings are readily known to one of ordinary skill in the art.

5           The seal coat may prevent excess moisture uptake by the matrices during the application of aqueous based enteric coatings. The gloss coat generally improves the handling of the finished matrices. Water-soluble materials such as hydroxypropylcellulose may be used to seal coat and gloss coat implants. The seal coat and gloss coat are generally sprayed onto the matrices until an increase in  
10 weight between about 0.5% and about 5%, often about 1% for a seal coat and about 3% for a gloss coat, has been obtained.

Enteric coatings consist of polymers which are insoluble in the low pH (less than 3.0) of the stomach, but are soluble in the elevated pH (greater than 4.0) of the small intestine. Polymers such as EUDRAGIT™, RohmTech, Inc., Malden, Mass.,  
15 and AQUATERIC™, FMC Corp., Philadelphia, Penn., may be used and are layered as thin membranes onto the implants from aqueous solution or suspension or by a spray drying method. The enteric coat is generally sprayed to a weight increase of about 1% to about 30%, preferably about 10 to about 15% and may contain coating adjuvants such as plasticizers, surfactants, separating agents that reduce the  
20 tackiness of the implants during coating, and coating permeability adjusters.

The present compositions may additionally contain one or more optional additives such as fibrous reinforcement, colorants, perfumes, rubber modifiers, modifying agents, etc. In practice, each of these optional additives should be compatible with the resulting polymer and its intended use. Examples of suitable  
25 fibrous reinforcement include PGA microfibrils, collagen microfibrils, cellulosic microfibrils, and olefinic microfibrils. The amount of each of these optional additives employed in the composition is an amount necessary to achieve the desired effect.

The therapeutic polymer conjugates as described herein can be administered  
30 in various pharmaceutical formulations, depending on the disorder to be treated and

the age, condition and body weight of the patient, as is well known in the art. For example, where the compounds are to be administered orally, they may be formulated as tablets, capsules, granules, powders or syrups; or for parenteral administration, they may be formulated as injections (intravenous, intramuscular or subcutaneous), drop infusion preparations or suppositories. For application by the ophthalmic mucous membrane route, they may be formulated as eyedrops or eye ointments. These formulations can be prepared by conventional means, and, if desired, the active ingredient may be mixed with any conventional additive, such as an excipient, a binder, a disintegrating agent, a lubricant, a corrigent, a solubilizing agent, a suspension aid, an emulsifying agent or a coating agent. Although the dosage will vary depending on the symptoms, age and body weight of the patient, the nature and severity of the disorder to be treated or prevented, the route of administration and the form of the drug, in general, a daily dosage of from 0.01 to 2000 mg of the therapeutic agent is recommended for an adult human patient, and this may be administered in a single dose or in divided doses.

The precise time of administration and/or amount of therapeutic polymer conjugate that will yield the most effective results in terms of efficacy of treatment in a given patient will depend upon the activity, pharmacokinetics, and bioavailability of a particular compound, physiological condition of the patient (including age, sex, disease type and stage, general physical condition, responsiveness to a given dosage and type of medication), route of administration, etc. However, the above guidelines can be used as the basis for fine-tuning the treatment, e.g., determining the optimum time and/or amount of administration, which will require no more than routine experimentation consisting of monitoring the subject and adjusting the dosage and/or timing.

The phrase "pharmaceutically acceptable" is employed herein to refer to those therapeutic polymer conjugates, materials, compositions, and/or dosage forms which are, within the scope of sound medical judgment, suitable for use in contact with the tissues of human beings and animals without excessive toxicity, irritation, allergic response, or other problem or complication, commensurate with a reasonable benefit/risk ratio.



The phrase "pharmaceutically acceptable carrier" as used herein means a pharmaceutically acceptable material, composition or vehicle, such as a liquid or solid filler, diluent, excipient, solvent or encapsulating material, involved in carrying or transporting the subject chemical from one organ, or portion of the body, to another organ, or portion of the body. Each carrier must be "acceptable" in the sense of being compatible with the other ingredients of the formulation and not injurious to the patient. Some examples of materials which can serve as pharmaceutically acceptable carriers include: (1) sugars, such as lactose, glucose and sucrose; (2) starches, such as corn starch and potato starch; (3) cellulose, and its derivatives, such as sodium carboxymethyl cellulose, ethyl cellulose and cellulose acetate; (4) powdered tragacanth; (5) malt; (6) gelatin; (7) talc; (8) excipients, such as cocoa butter and suppository waxes; (9) oils, such as peanut oil, cottonseed oil, safflower oil, sesame oil, olive oil, corn oil and soybean oil; (10) glycols, such as propylene glycol; (11) polyols, such as glycerin, sorbitol, mannitol and polyethylene glycol; (12) esters, such as ethyl oleate and ethyl laurate; (13) agar; (14) buffering agents, such as magnesium hydroxide and aluminum hydroxide; (15) alginic acid; (16) pyrogen-free water; (17) isotonic saline; (18) Ringer's solution; (19) ethyl alcohol; (20) phosphate buffer solutions; and (21) other non-toxic compatible substances employed in pharmaceutical formulations.

The term "pharmaceutically acceptable salts" refers to the relatively non-toxic, inorganic and organic acid addition salts of the therapeutic polymer conjugates. These salts can be prepared in situ during the final isolation and purification of the therapeutic polymer conjugates, or by separately reacting a purified polymer in its free base form with a suitable organic or inorganic acid, and isolating the salt thus formed. Representative salts include the hydrobromide, hydrochloride, sulfate, bisulfate, phosphate, nitrate, acetate, valerate, oleate, palmitate, stearate, laurate, benzoate, lactate, phosphate, tosylate, citrate, maleate, fumarate, succinate, tartrate, naphthylate, mesylate, glucoheptonate, lactobionate, and laurylsulphonate salts and the like. (See, for example, Berge et al. (1977) "Pharmaceutical Salts", *J. Pharm. Sci.* 66:1-19)

In other cases, the therapeutic polymer conjugates useful in the methods of the present invention may contain one or more acidic functional groups and, thus, are capable of forming pharmaceutically acceptable salts with pharmaceutically acceptable bases. The term "pharmaceutically acceptable salts" in these instances  
5 refers to the relatively non-toxic, inorganic and organic base addition salts of the polymer(s). These salts can likewise be prepared in situ during the final isolation and purification of the polymer(s), or by separately reacting the purified polymer(s) in its free acid form with a suitable base, such as the hydroxide, carbonate or bicarbonate of a pharmaceutically acceptable metal cation, with ammonia, or with a  
10 pharmaceutically acceptable organic primary, secondary or tertiary amine. Representative alkali or alkaline earth salts include the lithium, sodium, potassium, calcium, magnesium, and aluminum salts and the like. Representative organic amines useful for the formation of base addition salts include ethylamine, diethylamine, ethylenediamine, ethanolamine, diethanolamine, piperazine and the  
15 like (see, for example, Berge et al., *supra*).

Wetting agents, emulsifiers and lubricants, such as sodium lauryl sulfate and magnesium stearate, as well as coloring agents, release agents, coating agents, sweetening, flavoring and perfuming agents, preservatives and antioxidants can also be present in the compositions.

20 Examples of pharmaceutically acceptable antioxidants include: (1) water soluble antioxidants, such as ascorbic acid, cysteine hydrochloride, sodium bisulfate, sodium metabisulfite, sodium sulfite and the like; (2) oil-soluble antioxidants, such as ascorbyl palmitate, butylated hydroxyanisole (BHA), butylated hydroxytoluene (BHT), lecithin, propyl gallate, alpha-tocopherol, and the like; and (3) metal  
25 chelating agents, such as citric acid, ethylenediamine tetraacetic acid (EDTA), sorbitol, tartaric acid, phosphoric acid, and the like.

Formulations useful in the methods of the present invention include those suitable for oral, nasal, topical (including ophthalmic, otic, buccal and sublingual), rectal, vaginal, aerosol and/or parenteral administration. The formulations may  
30 conveniently be presented in unit dosage form and may be prepared by any methods well known in the art of pharmacy. The amount of active ingredient which can be



combined with a carrier material to produce a single dosage form will vary depending upon the host being treated, the particular mode of administration. The amount of active ingredient which can be combined with a carrier material to produce a single dosage form will generally be that amount of the compound which produces a therapeutic effect. Generally, out of one hundred per cent, this amount will range from about 1 per cent to about ninety-nine percent of active ingredient, preferably from about 5 per cent to about 70 per cent, most preferably from about 10 per cent to about 30 per cent.

Methods of preparing these formulations or compositions include the step of bringing into association a therapeutic polymer conjugate(s) with the carrier and, optionally, one or more accessory ingredients. In general, the formulations are prepared by uniformly and intimately bringing into association a therapeutic polymer conjugate with liquid carriers, or finely divided solid carriers, or both, and then, if necessary, shaping the product.

Formulations suitable for oral administration may be in the form of capsules, cachets, pills, tablets, gums, lozenges (using a flavored basis, usually sucrose and acacia or tragacanth), powders, granules, or as a solution or a suspension in an aqueous or non-aqueous liquid, or as an oil-in-water or water-in-oil liquid emulsion, or as an elixir or syrup, or as pastilles (using an inert base, such as gelatin and glycerin, or sucrose and acacia) and/or as mouthwashes and the like, each containing a predetermined amount of a therapeutic polymer conjugate(s) as an active ingredient. A compound may also be administered as a bolus, electuary or paste.

A tablet may be made by compression or molding, optionally with one or more accessory ingredients. Compressed tablets may be prepared using binder (for example, gelatin or hydroxypropylmethyl cellulose), lubricant, inert diluent, preservative, disintegrant (for example, sodium starch glycolate or cross-linked sodium carboxymethyl cellulose), surface-active or dispersing agent. Molded tablets may be made by molding in a suitable machine a mixture of the powdered peptide or peptidomimetic moistened with an inert liquid diluent.

Tablets, and other solid dosage forms, such as dragees, capsules, pills and granules, may optionally be scored or prepared with coatings and shells, such as enteric coatings and other coatings well known in the pharmaceutical-formulating art. They may also be formulated so as to provide slow or controlled release of the active ingredient therein using, for example, hydroxypropylmethyl cellulose in varying proportions to provide the desired release profile, other polymer matrices, liposomes and/or microspheres. They may be sterilized by, for example, filtration through a bacteria-retaining filter, or by incorporating sterilizing agents in the form of sterile solid compositions which can be dissolved in sterile water, or some other sterile injectable medium immediately before use. These compositions may also optionally contain opacifying agents and may be of a composition that they release the active ingredient(s) only, or preferentially, in a certain portion of the gastrointestinal tract, optionally, in a delayed manner. Examples of embedding compositions which can be used include polymeric substances and waxes. The active ingredient can also be in micro-encapsulated form, if appropriate, with one or more of the above-described excipients.

Liquid dosage forms for oral administration include pharmaceutically acceptable emulsions, microemulsions, solutions, suspensions, syrups and elixirs. In addition to the active ingredient, the liquid dosage forms may contain inert diluents commonly used in the art, such as, for example, water or other solvents, solubilizing agents and emulsifiers, such as ethyl alcohol, isopropyl alcohol, ethyl carbonate, ethyl acetate, benzyl alcohol, benzyl benzoate, propylene glycol, 1,3-butylene glycol, oils (in particular, cottonseed, groundnut, corn, germ, olive, castor and sesame oils), glycerol, tetrahydrofuryl alcohol, polyethylene glycols and fatty acid esters of sorbitan, and mixtures thereof.

Besides inert diluents, the oral compositions can also include adjuvants such as wetting agents, emulsifying and suspending agents, sweetening, flavoring, coloring, perfuming and preservative agents.

Suspensions, in addition to the active therapeutic polymer conjugates may contain suspending agents as, for example, ethoxylated isostearyl alcohols,



polyoxyethylene sorbitol and sorbitan esters, microcrystalline cellulose, aluminum metahydroxide, bentonite, agar-agar and tragacanth, and mixtures thereof.

Formulations for rectal or vaginal administration may be presented as a suppository, which may be prepared by mixing one or more therapeutic polymer  
5 conjugates with one or more suitable nonirritating excipients or carriers comprising for example, cocoa butter, polyethylene glycol, a suppository wax or a salicylate, and which is solid at room temperature, but liquid at body temperature and, therefore, will melt in the rectum or vaginal cavity and release the active agent.

Formulations which are suitable for vaginal administration also include  
10 pessaries, tampons, creams, gels, pastes, foams or spray formulations containing such carriers as are known in the art to be appropriate.

Dosage forms for the topical or transdermal administration of a therapeutic polymer conjugate(s) include powders, sprays, ointments, pastes, creams, lotions, gels, solutions, patches and inhalants. The active component may be mixed under  
15 sterile conditions with a pharmaceutically acceptable carrier, and with any preservatives, buffers, or propellants which may be required.

The ointments, pastes, creams and gels may contain, in addition to ligand(s), excipients, such as animal and vegetable fats, oils, waxes, paraffins, starch, tragacanth, cellulose derivatives, polyethylene glycols, silicones, bentonites, silicic  
20 acid, talc and zinc oxide, or mixtures thereof.

Powders and sprays can contain, in addition to a therapeutic polymer conjugate(s), excipients such as lactose, talc, silicic acid, aluminum hydroxide, calcium silicates and polyamide powder, or mixtures of these substances. Sprays can additionally contain customary propellants, such as chlorofluorocarbons  
25 and volatile unsubstituted hydrocarbons, such as butane and propane.

The therapeutic polymer conjugate(s) can be alternatively administered by aerosol. This is accomplished by preparing an aqueous aerosol, liposomal preparation or solid particles containing the compound. A nonaqueous (e.g., fluorocarbon propellant) suspension could be used. Sonic nebulizers are preferred

because they minimize exposing the agent to shear, which can result in degradation of the compound.

Ordinarily, an aqueous aerosol is made by formulating an aqueous solution or suspension of the agent together with conventional pharmaceutically acceptable carriers and stabilizers. The carriers and stabilizers vary with the requirements of  
5 the particular compound, but typically include nonionic surfactants (Tweens, Pluronic, or polyethylene glycol), innocuous proteins like serum albumin, sorbitan esters, oleic acid, lecithin, amino acids such as glycine, buffers, salts, sugars or sugar alcohols. Aerosols generally are prepared from isotonic solutions.

10 Transdermal patches have the added advantage of providing controlled delivery of a therapeutic polymer conjugate(s) to the body. Such dosage forms can be made by dissolving or dispersing the agent in the proper medium. Absorption enhancers can also be used to increase the flux of the ligand across the skin. The rate of such flux can be controlled by either providing a rate controlling membrane  
15 or dispersing the peptidomimetic in a polymer matrix or gel.

Ophthalmic formulations, eye ointments, powders, solutions and the like, are also contemplated as being within the scope of this invention.

Pharmaceutical compositions of this invention suitable for parenteral administration comprise one or more therapeutic polymer conjugate(s) in  
20 combination with one or more pharmaceutically acceptable sterile isotonic aqueous or nonaqueous solutions, dispersions, suspensions or emulsions, or sterile powders which may be reconstituted into sterile injectable solutions or dispersions just prior to use, which may contain antioxidants, buffers, bacteriostats, solutes which render the formulation isotonic with the blood of the intended recipient or suspending or  
25 thickening agents.

Examples of suitable aqueous and nonaqueous carriers which may be employed in the pharmaceutical compositions of the invention include water, ethanol, polyols (such as glycerol, propylene glycol, polyethylene glycol, and the like), and suitable mixtures thereof, vegetable oils, such as olive oil, and injectable



organic esters, such as ethyl oleate. Proper fluidity can be maintained, for example, by the use of coating materials, such as lecithin, by the maintenance of the required particle size in the case of dispersions, and by the use of surfactants.

5 These compositions may also contain adjuvants such as preservatives, wetting agents, emulsifying agents and dispersing agents. Prevention of the action of microorganisms may be ensured by the inclusion of various antibacterial and antifungal agents, for example, paraben, chlorobutanol, phenol sorbic acid, and the like. It may also be desirable to include isotonic agents, such as sugars, sodium chloride, and the like into the compositions. In addition, prolonged absorption of the  
10 injectable pharmaceutical form may be brought about by the inclusion of agents which delay absorption such as aluminum monostearate and gelatin.

In some cases, in order to prolong the effect of a drug, it is desirable to slow the absorption of the drug from subcutaneous or intramuscular injection. This may be accomplished by the use of a liquid suspension of crystalline or amorphous  
15 material having poor water solubility. The rate of absorption of the drug then depends upon its rate of dissolution which, in turn, may depend upon crystal size and crystalline form. Alternatively, delayed absorption of a parenterally administered drug form is accomplished by dissolving or suspending the drug in an oil vehicle.

20 Injectable depot forms are made by forming microcapsule matrices of therapeutic polymer conjugate(s) in biodegradable polymers such as polylactide-polyglycolide. Depending on the ratio of drug to polymer, and the nature of the particular polymer employed, the rate of drug release can be controlled. Examples of other biodegradable polymers include poly(orthoesters) and poly(anhydrides).  
25 Depot injectable formulations are also prepared by entrapping the drug in liposomes or microemulsions which are compatible with body tissue.

When the therapeutic polymer conjugate(s) of the present invention are administered as pharmaceuticals, to humans and animals, they can be given per se or as a pharmaceutical composition containing, for example, 0.1 to 99.5% (more

preferably, 0.5 to 90%) of active ingredient in combination with a pharmaceutically acceptable carrier.

The preparations of agents may be given orally, parenterally, topically, or rectally. They are of course given by forms suitable for each administration route.  
5 For example, they are administered in tablets or capsule form, by injection, inhalation, eye lotion, ointment, suppository, infusion; topically by lotion or ointment; and rectally by suppositories. Oral administration is preferred.

The phrases "parenteral administration" and "administered parenterally" as used herein means modes of administration other than enteral and topical  
10 administration, usually by injection, and includes, without limitation, intravenous, intramuscular, intraarterial, intrathecal, intracapsular, intraorbital, intracardiac, intradermal, intraperitoneal, transtracheal, subcutaneous, subcuticular, intraarticular, subcapsular, subarachnoid, intraspinal and intrasternal injection and infusion.

The phrases "systemic administration," "administered systemically,"  
15 "peripheral administration" and "administered peripherally" as used herein mean the administration of a therapeutic polymer conjugate, drug or other material other than directly into the central nervous system, such that it enters the patient's system and, thus, is subject to metabolism and other like processes, for example, subcutaneous administration.

20 These therapeutic polymer conjugate(s) may be administered to humans and other animals for therapy by any suitable route of administration, including orally, nasally, as by, for example, a spray, rectally, intravaginally, parenterally, intracisternally and topically, as by powders, ointments or drops, including buccally and sublingually.

25 Regardless of the route of administration selected, the therapeutic polymer conjugate(s), which may be used in a suitable hydrated form, and/or the pharmaceutical compositions of the present invention, are formulated into pharmaceutically acceptable dosage forms by conventional methods known to those of skill in the art.



Actual dosage levels of the active ingredients in the pharmaceutical compositions of this invention may be varied so as to obtain an amount of the active ingredient which is effective to achieve the desired therapeutic response for a particular patient, composition, and mode of administration, without being toxic to  
5 the patient.

(c) Physical Structures Of The Subject Compositions

The subject polymers may be formed in a variety of shapes. For example, in certain embodiments, subject polymer matrices may be presented in the form of microparticles or nanoparticles. Microspheres typically comprise a biodegradable  
10 polymer matrix incorporating a drug. Microspheres can be formed by a wide variety of techniques known to those of skill in the art. Examples of microsphere forming techniques include, but are not limited to, (a) phase separation by emulsification and subsequent organic solvent evaporation (including complex emulsion methods such as oil in water emulsions, water in oil emulsions and water-oil-water emulsions); (b)  
15 coacervation-phase separation; (c) melt dispersion; (d) interfacial deposition; (e) in situ polymerization; (f) spray drying and spray congealing; (g) air suspension coating; and (h) pan and spray coating. These methods, as well as properties and characteristics of microspheres are disclosed in, for example, U.S. Pat. No. 4,652,441; U.S. Pat. No. 5,100,669; U.S. Pat. No. 4,526,938; WO 93/24150;  
20 EPA 0258780 A2; U.S. Pat. No. 4,438,253; and U.S. Pat. 5,330,768.

To prepare microspheres of the present invention, several methods can be employed depending upon the desired application of the delivery vehicles. Suitable methods include, but are not limited to, spray drying, freeze drying, air drying,  
25 vacuum drying, fluidized-bed drying, milling, co-precipitation and critical fluid extraction. In the case of spray drying, freeze drying, air drying, vacuum drying, fluidized-bed drying and critical fluid extraction; the components (stabilizing polyol, bioactive material, buffers, etc.) are first dissolved or suspended in aqueous conditions. In the case of milling, the components are mixed in the dried form and  
30 milled by any method known in the art. In the case of co-precipitation, the components are mixed in organic conditions and processed as described below.

Spray drying can be used to load the stabilizing polyol with the bioactive material. The components are mixed under aqueous conditions and dried using precision nozzles to produce extremely uniform droplets in a drying chamber. Suitable spray drying machines include, but are not limited to, Buchi, NIRO, APV and Lab-plant spray driers used according to the manufacturer's instructions.

The shape of microparticles and nanoparticles may be determined by scanning electron microscopy. Spherically shaped nanoparticles are used in certain embodiments, for circulation through the bloodstream. If desired, the particles may be fabricated using known techniques into other shapes that are more useful for a specific application.

In addition to intracellular delivery of a therapeutic agent, it also possible that particles of the subject compositions, such as microparticles or nanoparticles, may undergo endocytosis, thereby obtaining access to the cell. The frequency of such an endocytosis process will likely depend on the size of any particle.

In certain embodiments, solid articles useful in defining shape and providing rigidity and structural strength to the polymeric matrices may be used. For example, a polymer may be formed on a mesh or other weave for implantation. A polymer may also be fabricated as a stent or as a shunt, adapted for holding open areas within body tissues or for draining fluid from one body cavity or body lumen into another. Further, a polymer may be fabricated as a drain or a tube suitable for removing fluid from a post-operative site, and in some embodiments adaptable for use with closed section drainage systems such as Jackson-Pratt drains and the like as are familiar in the art.

The mechanical properties of the polymer may be important for the processability of making molded or pressed articles for implantation. For example, the glass transition temperature may vary widely but must be sufficiently lower than the temperature of decomposition to accommodate conventional fabrication techniques, such, as compression molding, extrusion, or injection molding.

(d) *Biodegradability And Release Characteristics*



In certain embodiments, the polymers and blends of the present invention, upon contact with body fluids, undergo gradual degradation. The life of a biodegradable polymer in vivo depends upon, among other things, its molecular weight, crystallinity, biostability, and the degree of crosslinking. In general, the  
5 greater the molecular weight, the higher the degree of crystallinity, and the greater the biostability, the slower biodegradation will be.

If a subject composition is formulated with a therapeutic agent or other material, release of such an agent or other material for a sustained or extended period as compared to the release from an isotonic saline solution generally results.  
10 Such release profile may result in prolonged delivery (over, say 1 to about 2,000 hours, or alternatively about 2 to about 800 hours) of effective amounts (e.g., about 0.0001 mg/kg/hour to about 1.0 mg/kg/hour) of the agent or any other material associated with the polymer.

A variety of factors may affect the desired rate of hydrolysis of polymers of  
15 the subject invention, the desired softness and flexibility of the resulting solid matrix, rate and extent of bioactive material release. Some of such factors include the selection/identity of the various subunits, the enantiomeric or diastereomeric purity of the monomeric subunits, homogeneity of subunits found in the polymer, and the length of the polymer. For instance, the present invention contemplates  
20 heteropolymers with varying linkages, and/or the inclusion of other monomeric elements in the polymer, in order to control, for example, the rate of biodegradation of the matrix.

To illustrate further, a wide range of degradation rates may be obtained by adjusting the hydrophobicities of the backbones or side chains of the polymers while  
25 still maintaining sufficient biodegradability for the use intended for any such polymer. Such a result may be achieved by varying the various functional groups of the polymer. For example, the combination of a hydrophobic backbone and a hydrophilic linkage produces heterogeneous degradation because cleavage is encouraged whereas water penetration is resisted.

One protocol generally accepted in the field that may be used to determine the release rate of any therapeutic agent or other material loaded in the polymer matrices of the present invention involves degradation of any such matrix in a 0.1 M PBS solution (pH 7.4) at 37 °C, an assay known in the art. For purposes of the present invention, the term "PBS protocol" is used herein to refer to such protocol.

In certain instances, the release rates of different polymer systems of the present invention may be compared by subjecting them to such a protocol. In certain instances, it may be necessary to process polymeric systems in the same fashion to allow direct and relatively accurate comparisons of different systems to be made. For example, the present invention teaches several different means of formulating the polymeric, matrices of the present invention. Such comparisons may indicate that any one polymeric system releases incorporated material at a rate from about 2 or less to about 1000 or more times faster than another polymeric system.

Alternatively, a comparison may reveal a rate difference of about 3, 5, 7, 10, 25, 50, 100, 250, 500 or 750 times. Even higher rate differences are contemplated by the present invention and release rate protocols.

In certain embodiments, when formulated in a certain manner, the release rate for polymer systems of the present invention may present as mono- or bi-phasic.

Release of any material incorporated into the polymer matrix, which is often provided as a microsphere, may be characterized in certain instances by an initial increased release rate, which may release from about 5 to about 50% or more of any incorporated material, or alternatively about 10, 15, 20, 25, 30 or 40%, followed by a release rate of lesser magnitude.

The release rate of any incorporated material may also be characterized by the amount of such material released per day per mg of polymer matrix. For example, in certain embodiments, the release rate may vary from about 1 ng or less of any incorporated material per day per mg of polymeric system to about 500 or more ng/day/mg. Alternatively, the release rate may be about 0.05, 0.5, 5, 10, 25,



50, 75, 100, 125, 150, 175, 200, 250, 300, 350, 400, 450, or 500 ng/day/mg. In still other embodiments, the release rate of any incorporated material may be 10,000 ng/day/mg, or even higher. In certain instances, materials incorporated and characterized by such release rate protocols may include therapeutic agents, fillers, and other substances.

In another aspect, the rate of release of any material from any polymer matrix of the present invention may be presented as the half-life of such material in the matrix.

In addition to the embodiment involving protocols for in vitro determination of release rates, in vivo protocols, whereby in certain instances release rates for polymeric systems may be determined in vivo, are also contemplated by the present invention. Other assays useful for determining the release of any material from the polymers of the present system are known in the art.

(e) Implants and Delivery Systems

In its simplest form, a biodegradable delivery system for a therapeutic agent consists of a dispersion of such a therapeutic agent in a polymer matrix. In other embodiments, an article is used for implantation, injection, or otherwise placed totally or partially within the body, the article comprising the subject compositions. It is particularly important that such an article result in minimal tissue irritation when implanted or injected into vasculated tissue.

Biodegradable delivery systems, and articles thereof, may be prepared in a variety of ways known in the art. The subject polymer may be melt-processed using conventional extrusion or injection molding techniques, or these products may be prepared by dissolving in an appropriate solvent, followed by formation of the device, and subsequent removal of the solvent by evaporation or extraction.

Once a system or implant article is in place, it should remain in at least partial contact with a biological fluid, such as blood, internal organ secretions, mucus membranes, cerebrospinal fluid, and the like to allow for sustained release of any encapsulated therapeutic agent.

(f) Methods of Manufacturing

Generally, compounds of the present invention can be prepared in one of two ways: monomers bearing therapeutic agents, targeting ligands, and/or cyclodextrin moieties can be polymerized, or polymer backbones can be derivatized with  
5 therapeutic agents, targeting ligands, and/or cyclodextrin moieties.

Thus, in one embodiment, the present invention contemplates the synthesis of compounds of the invention by reacting monomers M-L-CD and M-L-D (and, optionally, M-L-T), wherein

CD represents a cyclic moiety, such as a cyclodextrin molecule, or derivative  
10 thereof;

L, independently for each occurrence, may be absent or represents a linker group;

D, independently for each occurrence, represents the same or different therapeutic agent or prodrugs thereof;

15 T, independently for each occurrence, represents the same or different targeting ligand or precursor thereof; and

M represents a monomer subunit bearing one or more reactive moieties capable of undergoing a polymerization reaction with one or more other M in the monomers in the reaction mixture, under conditions that cause polymerization of the  
20 monomers to take place.

In certain embodiments, the reaction mixture may further comprise monomers that do not bear CD, T, or D moieties, e.g., to space the derivatized monomer units throughout the polymer.

In an alternative embodiment, the invention contemplates synthesizing a  
25 compound of the present invention by reacting a polymer P (the polymer bearing a plurality of reactive groups, such as carboxylic acids, alcohols, thiols, amines, epoxides, etc.) with grafting agents X-L-CD and Y-L-D (and, optionally, Z-L-T), wherein

CD represents a cyclic moiety, such as a cyclodextrin molecule, or derivative  
30 thereof;



L, independently for each occurrence, may be absent or represents a linker group;

D, independently for each occurrence, represents the same or different therapeutic agent or prodrugs thereof;

5 T, independently for each occurrence, represents the same or different targeting ligand or precursor thereof;

X, independently for each occurrence, represents a reactive group, such as carboxylic acids, alcohols, thiols, amines, epoxides, etc., capable of forming a covalent bond with a reactive group of the polymer; and

10 Y and Z, independently for each occurrence, represent inclusion hosts or reactive groups, such as carboxylic acids, alcohols, thiols, amines, epoxides, etc., capable of forming a covalent bond with a reactive group of the polymer or inclusion complexes with CD moieties grafted to the polymer, under conditions that cause the grafting agents to form covalent bonds and/or inclusion complexes, as  
15 appropriate, with the polymer or moieties grafted to the polymer.

For example, if the polymer includes alcohols, thiols, or amines as reactive groups, the grafting agents may include reactive groups that react with them, such as isocyanates, isothiocyanates, acid chlorides, acid anhydrides, epoxides, ketenes, sulfonyl chlorides, activated carboxylic acids (e.g., carboxylic acids treated with an  
20 activating agent such as PyBrOP, carbonyldiimidazole, or another reagent that reacts with a carboxylic acid to form a moiety susceptible to nucleophilic attack), or other electrophilic moieties known to those of skill in the art. In certain embodiments, a catalyst may be needed to cause the reaction to take place (e.g., a Lewis acid, a transition metal catalyst, an amine base, etc.) as will be understood by those of skill  
25 in the art.

In certain embodiments, the different grafting agents are reacted with the polymer simultaneously or substantially simultaneously (e.g., in a one-pot reaction), or are reacted sequentially with the polymer (optionally with a purification and/or wash step between reactions).

30 Another aspect of the present invention is a method for manufacturing the linear or branched cyclodextrin-containing polymers represented by formulae I-III.

While the discussion below focuses on the preparation of linear cyclodextrin molecules, one skilled in the art would readily recognize that the methods described can be adapted for producing branched polymers by choosing an appropriate comonomer A precursor.

5           Accordingly, one embodiment of the invention is a method of preparing a linear cyclodextrin copolymer. According to the invention, a linear cyclodextrin copolymer of the invention may be prepared by copolymerizing a cyclodextrin monomer precursor disubstituted with an appropriate leaving group with a comonomer A precursor capable of displacing the leaving groups. The leaving  
10   group, which may be the same or different, may be any leaving group known in the art which may be displaced upon copolymerization with a comonomer A precursor. In a preferred embodiment, a linear cyclodextrin copolymer may be prepared by iodinating a cyclodextrin monomer precursor to form a diiodinated cyclodextrin monomer precursor and copolymerizing the diiodinated cyclodextrin monomer  
15   precursor with a comonomer A precursor to form a linear cyclodextrin copolymer having a repeating unit of formula II or III, or a combination thereof, each as described above. While examples presented below discuss iodinated cyclodextrin moieties, one skilled in the art would readily recognize that the present invention contemplates and encompasses cyclodextrin moieties wherein other leaving groups  
20   such as alkyl and aryl sulfonate may be present instead of iodo groups. In a preferred embodiment, a method of preparing a linear cyclodextrin copolymer of the invention by iodinating a cyclodextrin monomer precursor as described above to form a diiodinated cyclodextrin monomer precursor of formula IVa, IVb, IVc or a mixture thereof:



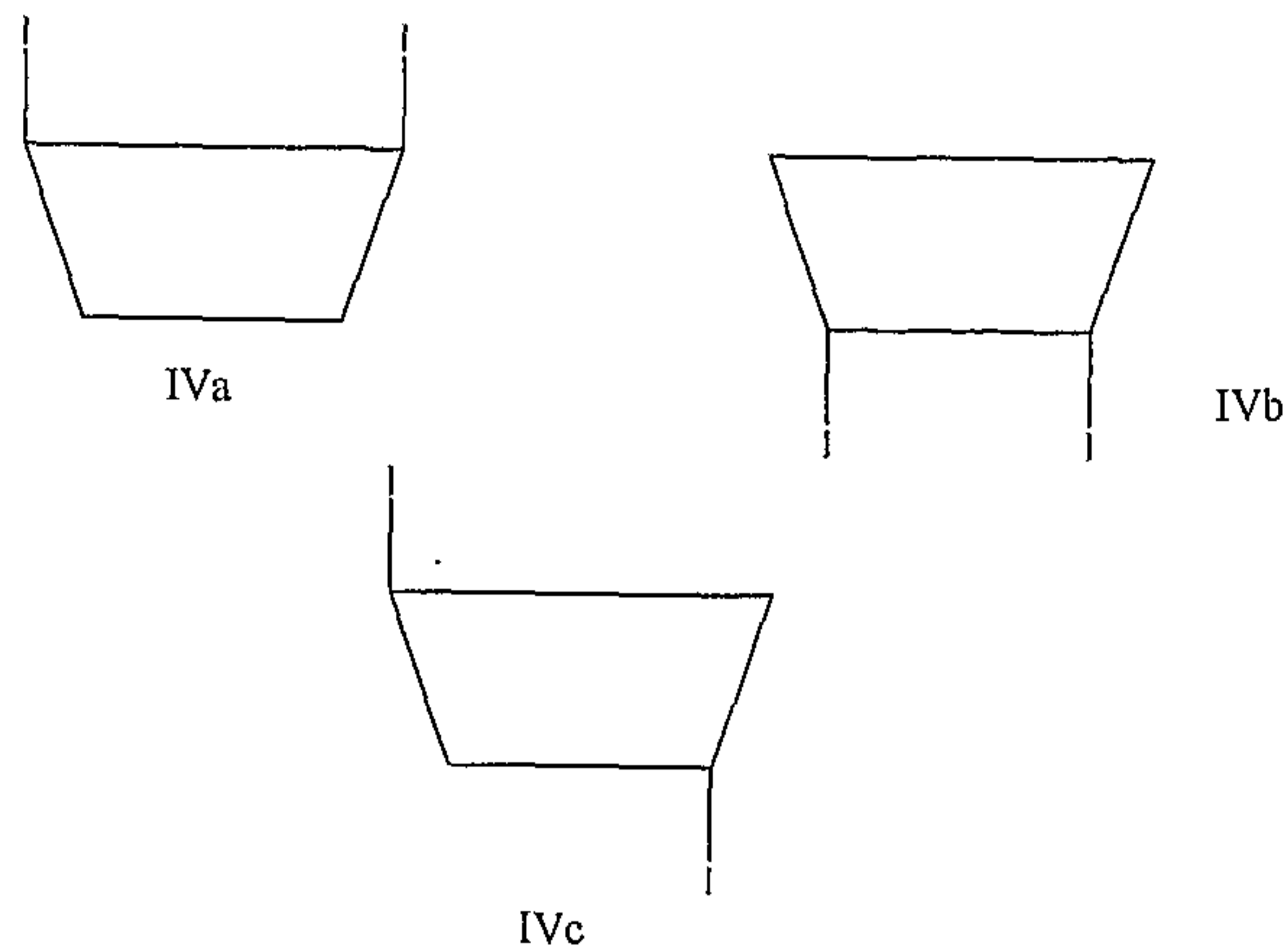

The diiodinated cyclodextrin may be prepared by any means known in the art. (Tabushi et al. J. Am. Chem. 106, 5267-5270 (1984); Tabushi et al. J. Am. Chem. 106, 4580-4584 (1984)). For example,  $\beta$ -cyclodextrin may be reacted with  
5 biphenyl-4,4'-disulfonyl chloride in the presence of anhydrous pyridine to form a biphenyl-4,4'-disulfonyl chloride capped  $\beta$ -cyclodextrin which may then be reacted with potassium iodide to produce diiodo- $\beta$ -cyclodextrin. The cyclodextrin monomer precursor is iodinated at only two positions. By copolymerizing the diiodinated cyclodextrin monomer precursor with a comonomer A precursor, as described  
10 above, a linear cyclodextrin polymer having a repeating unit of Formula Ia, Ib, or a combination thereof, also as described above, may be prepared. If appropriate, the iodine or iodo groups may be replaced with other known leaving groups.

Also according to the invention, the iodo groups or other appropriate leaving group may be displaced with a group that permits reaction with a comonomer A  
15 precursor, as described above. For example, a diiodinated cyclodextrin monomer precursor of formula IVa, IVb, IVc or a mixture thereof may be aminated to form a diaminated cyclodextrin monomer precursor of formula Va, Vb, Vc or a mixture thereof:

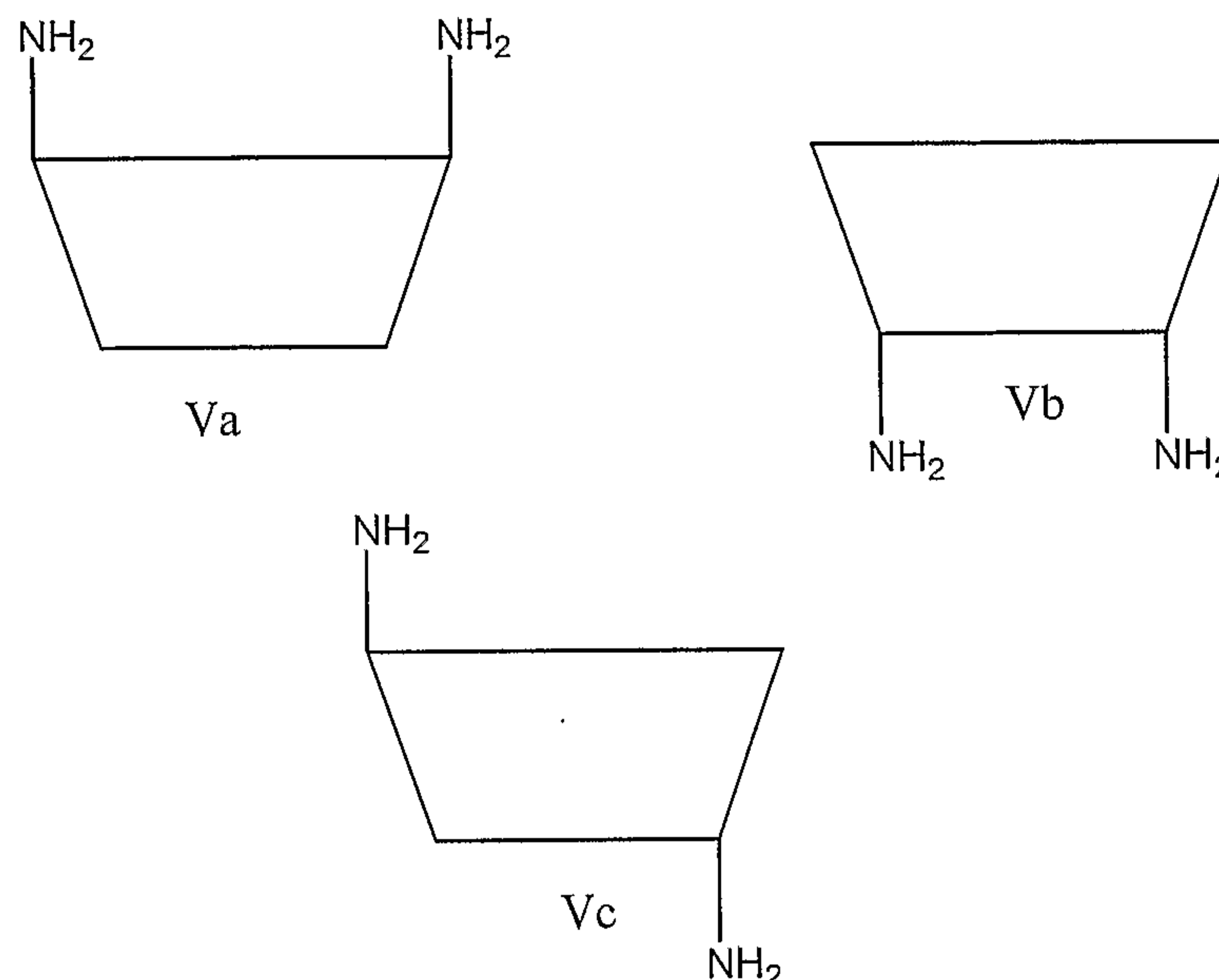

The diaminated cyclodextrin monomer precursor may be prepared by any means known in the art. (Tabushi et al. *Tetrahedron Lett.* 18:11527-1530 (1977); Mungall et al., *J. Org. Chem.* 16591662 (1975)). For example, a diiodo- $\beta$ -

5 cyclodextrin may be reacted with sodium azide and then reduced to form a diamino- $\beta$ -cyclodextrin). The cyclodextrin monomer precursor is aminated at only two positions. The diaminated cyclodextrin monomer precursor may then be copolymerized with a comonomer A precursor, as described above, to produce a linear cyclodextrin copolymer having a repeating unit of formula II-III or a

10 combination thereof, also as described above. However, the amino functionality of a diaminated cyclodextrin monomer precursor need not be directly attached to the cyclodextrin moiety. Alternatively, the amino functionality or another nucleophilic functionality may be introduced by displacement of the iodo or other appropriate leaving groups of a cyclodextrin monomer precursor with amino group containing

15 moieties such as, for example,  $\text{HSCH}_2\text{CH}_2\text{NH}_2$  (or a di-nucleophilic molecule more generally represented by  $\text{HW}-(\text{CR}_1\text{R}_2)_n-\text{WH}$  wherein W, independently for each occurrence, represents O, S, or  $\text{NR}_1$ ;  $\text{R}_1$  and  $\text{R}_2$ , independently for each occurrence, represent H, (un)substituted alkyl, (un)substituted aryl, (un)substituted heteroalkyl, (un)substituted heteroaryl) with an appropriate base such as a metal hydride, alkali

20 or alkaline carbonate, or tertiary amine to form a diaminated cyclodextrin monomer precursor of formula Vd, Ve, Vf or a mixture thereof:



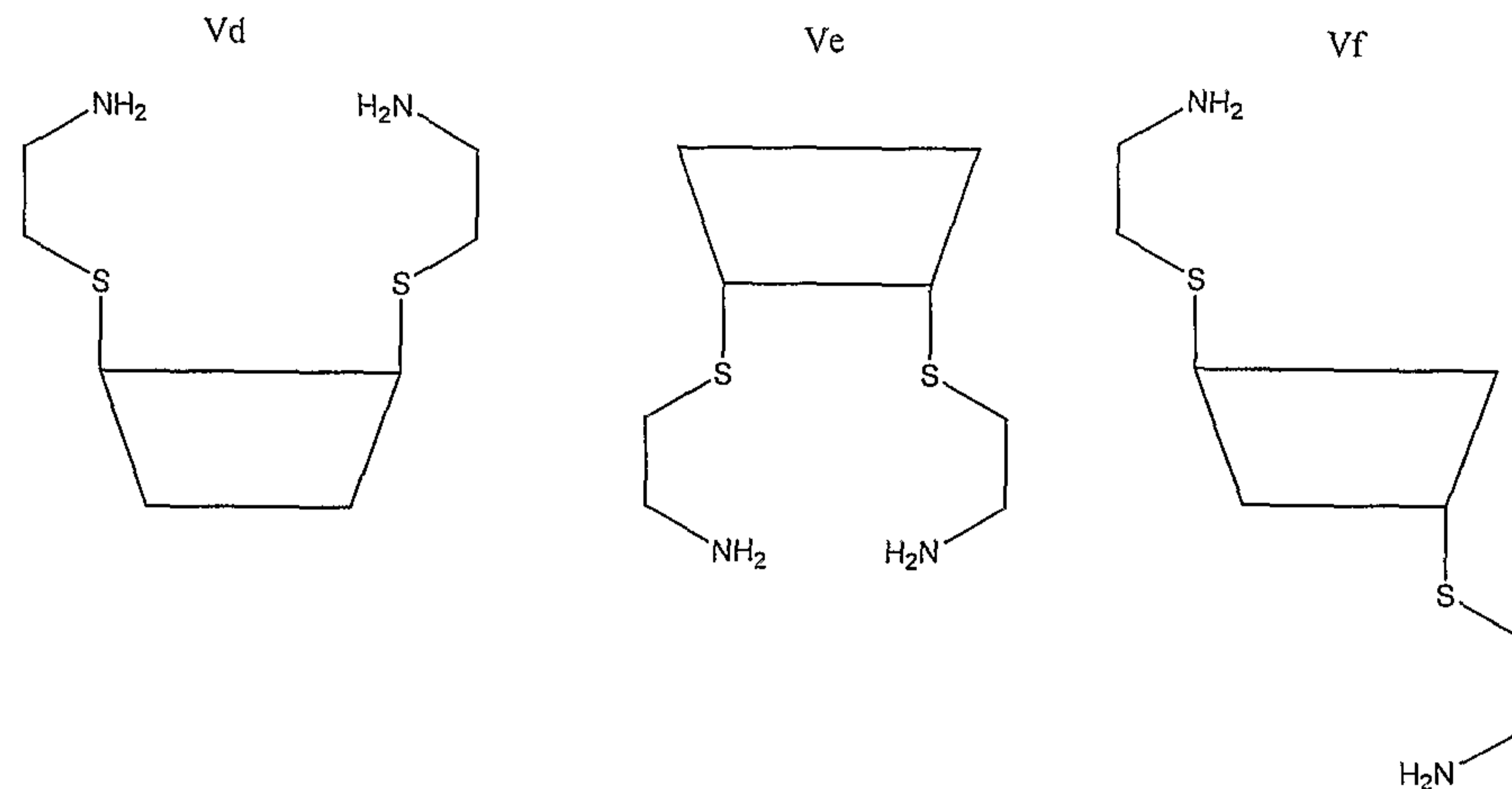

A linear oxidized cyclodextrin-containing copolymer of the invention may also be prepared by oxidizing a reduced linear cyclodextrin-containing copolymer of the invention as described below. This method may be performed as long as the  
 5 comonomer A does not contain an oxidation sensitive moiety or group such as, for example, a thiol.

According to the invention, a linear cyclodextrin copolymer of the invention may be oxidized so as to introduce at least one oxidized cyclodextrin monomer into the copolymer such that the oxidized cyclodextrin monomer is an integral part of the  
 10 polymer backbone. A linear cyclodextrin copolymer which contains at least one oxidized cyclodextrin monomer is defined as a linear oxidized cyclodextrin copolymer or a linear oxidized cyclodextrin-containing polymer. The cyclodextrin monomer may be oxidized on either the secondary or primary hydroxyl side of the cyclodextrin moiety. If more than one oxidized cyclodextrin monomer is present in  
 15 a linear oxidized cyclodextrin copolymer of the invention, the same or different cyclodextrin monomers oxidized on either the primary hydroxyl side, the secondary hydroxyl side, or both may be present. For illustration purposes, a linear oxidized cyclodextrin copolymer with oxidized secondary hydroxyl groups has, for example, at least one unit of formula VIa or VIb:

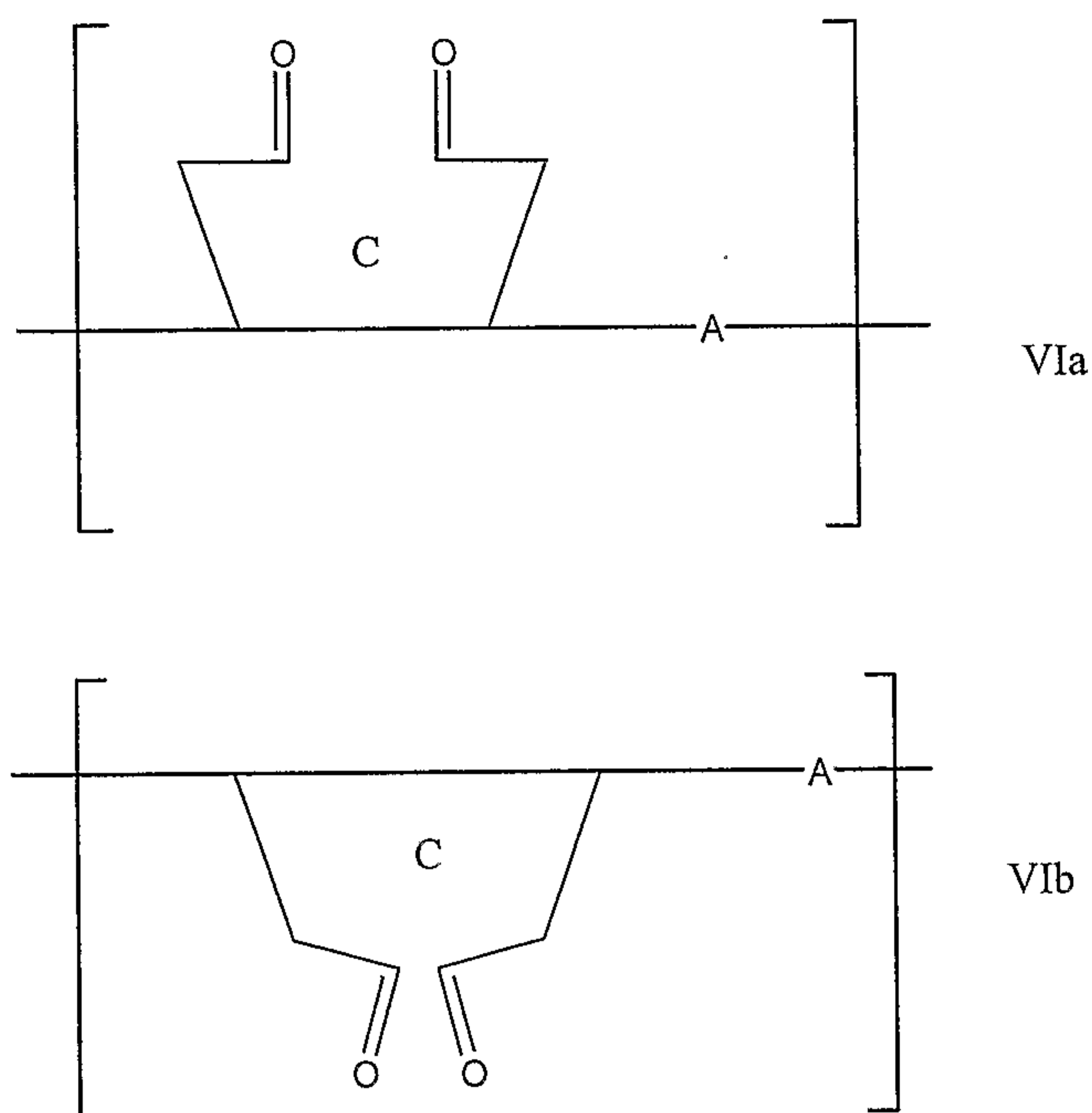

In formulae VIa and VIb, C is a substituted or unsubstituted oxidized cyclodextrin monomer and A is a comonomer bound, i.e., covalently bound, to the oxidized cyclodextrin C. Also in formulae VIa and VIb, oxidation of the secondary hydroxyl groups leads to ring opening of the cyclodextrin moiety and the formation of aldehyde groups.

A linear oxidized cyclodextrin copolymer may be prepared by oxidation of a linear cyclodextrin copolymer as discussed above. Oxidation of a linear cyclodextrin copolymer of the invention may be accomplished by oxidation techniques known in the art. (Hisamatsu et al., Starch 44:188-191 (1992)). Preferably, an oxidant such as, for example, sodium periodate is used. It would be understood by one of ordinary skill in the art that under standard oxidation conditions that the degree of oxidation may vary or be varied per copolymer. Thus in one embodiment of the invention, a linear oxidized copolymer of the invention may contain one oxidized cyclodextrin monomer. In another embodiment, substantially all cyclodextrin monomers of the copolymer would be oxidized.

Another method of preparing a linear oxidized cyclodextrin copolymer of the invention involves the oxidation of a diiodinated or diaminated cyclodextrin



monomer precursor, as described above, to form an oxidized diiodinated or  
 diaminated cyclodextrin monomer precursor and copolymerization of the oxidized  
 diiodinated or diaminated cyclodextrin monomer precursor with a comonomer A  
 precursor. In a preferred embodiment, an oxidized diiodinated cyclodextrin  
 5 monomer precursor of formula VIIa, VIIb, VIIc, or a mixture thereof:

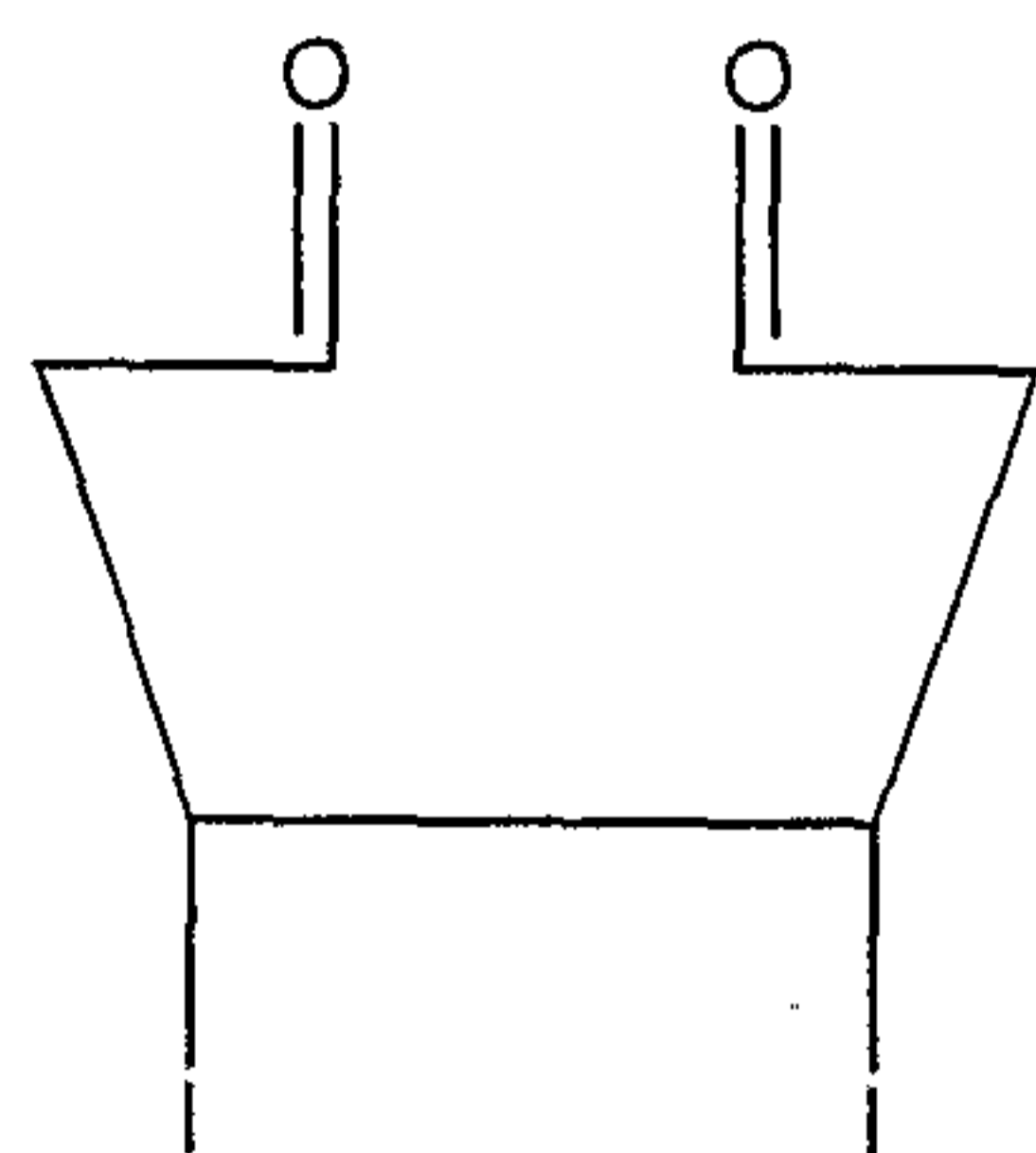

VIIa

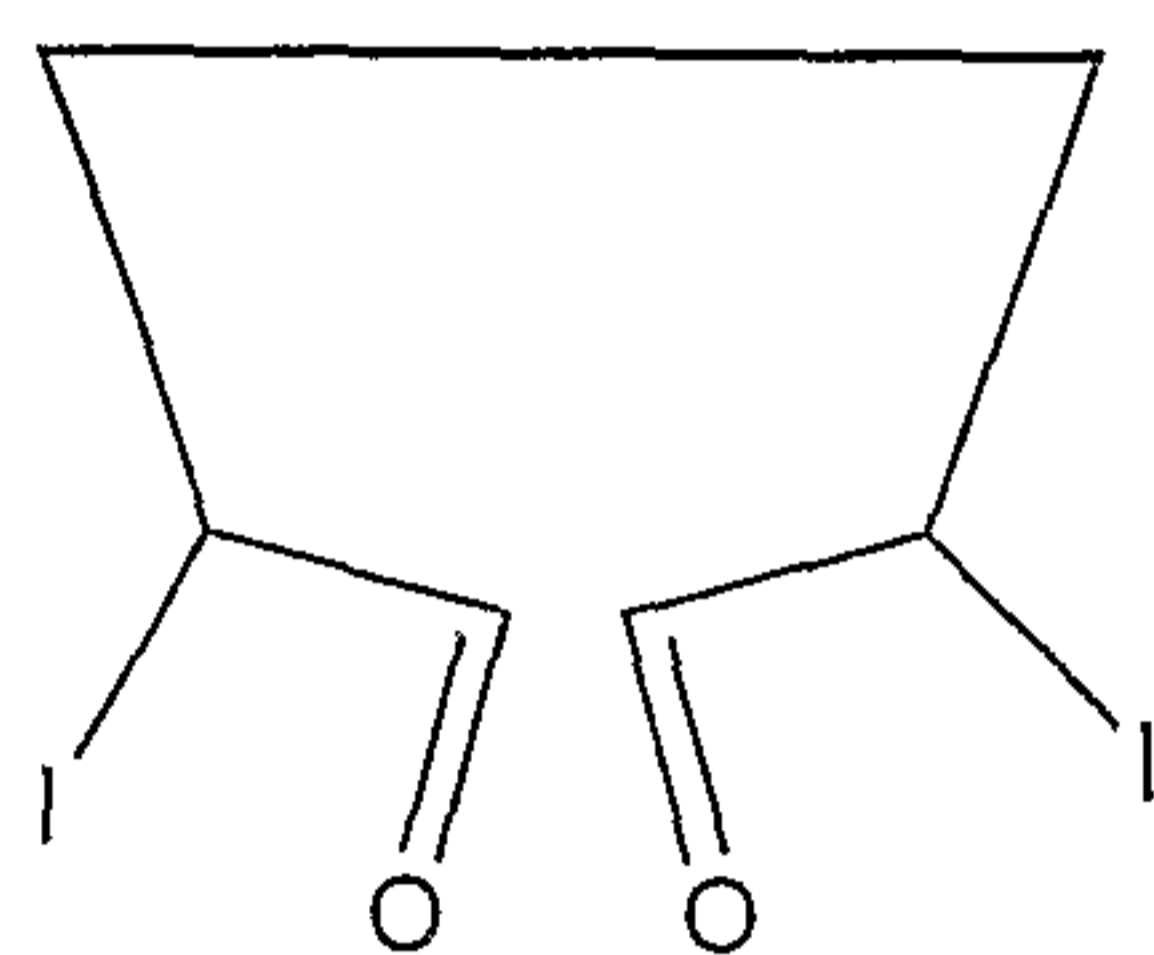

VIIb

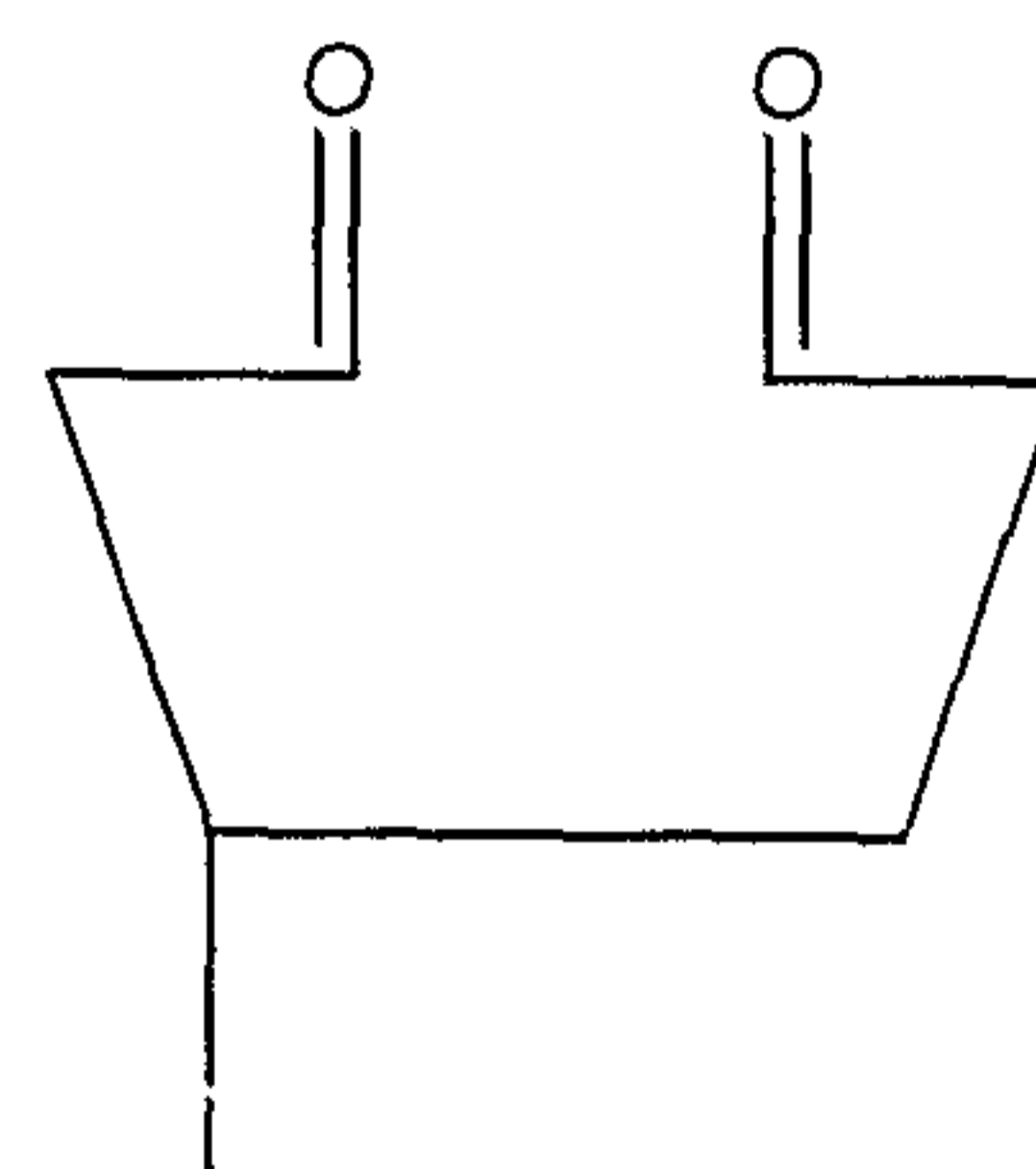

VIIc

may be prepared by oxidation of a diiodinated cyclodextrin monomer precursor of  
 formulae IVa, IVb, IVc, or a mixture thereof, as described above. In another  
 preferred embodiment, an oxidized diaminated cyclodextrin monomer precursor of  
 10 formula VIIIa, VIIIb, VIIIc or a mixture thereof:

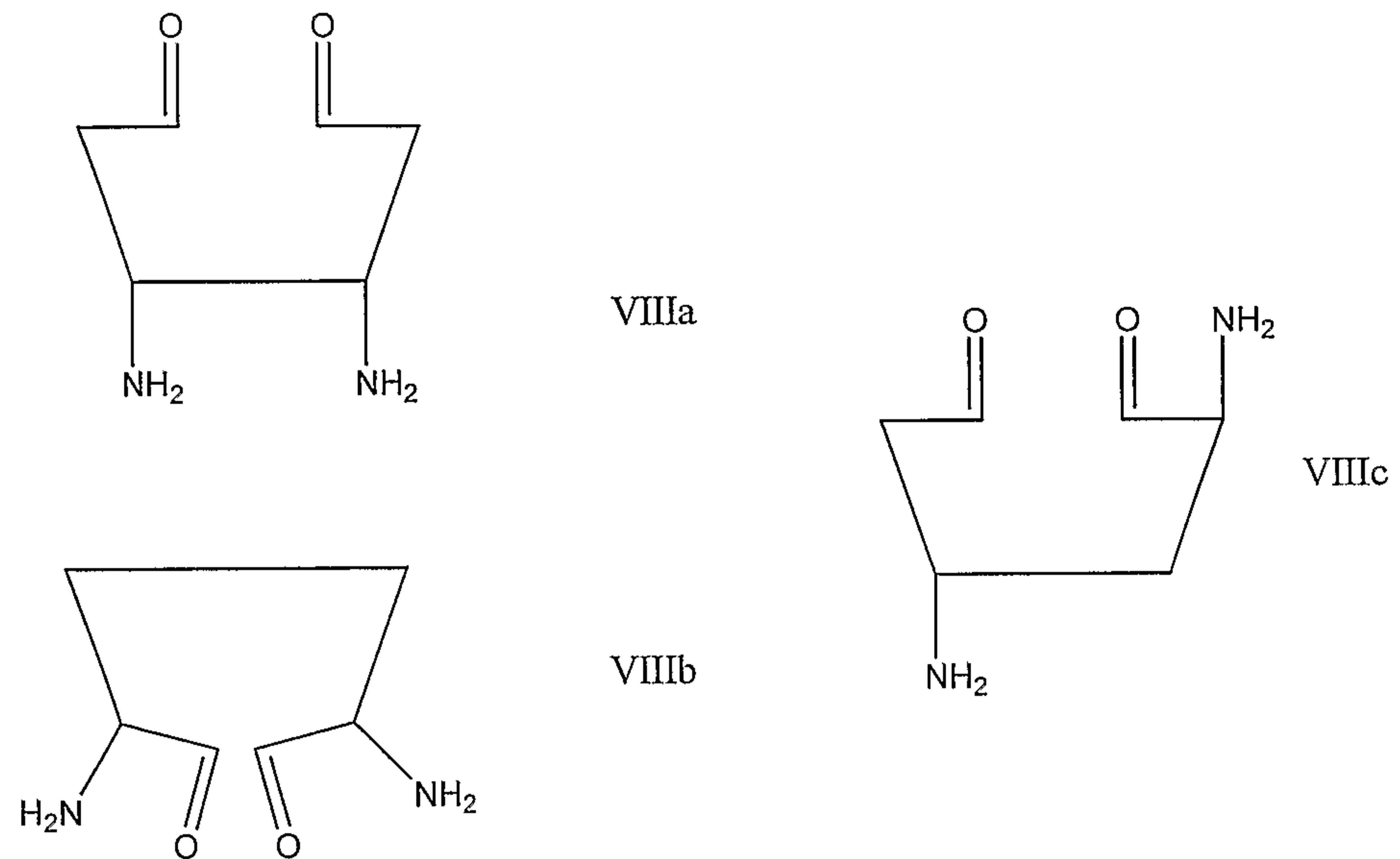

may be prepared by amination of an oxidized diiodinated cyclodextrin monomer precursor of formulae VIIa, VIIb, VIIc, or a mixture thereof, as described above. In still another preferred embodiment, an oxidized diaminated cyclodextrin monomer precursor of formula IXa, IXb, IXc or a mixture thereof:

5

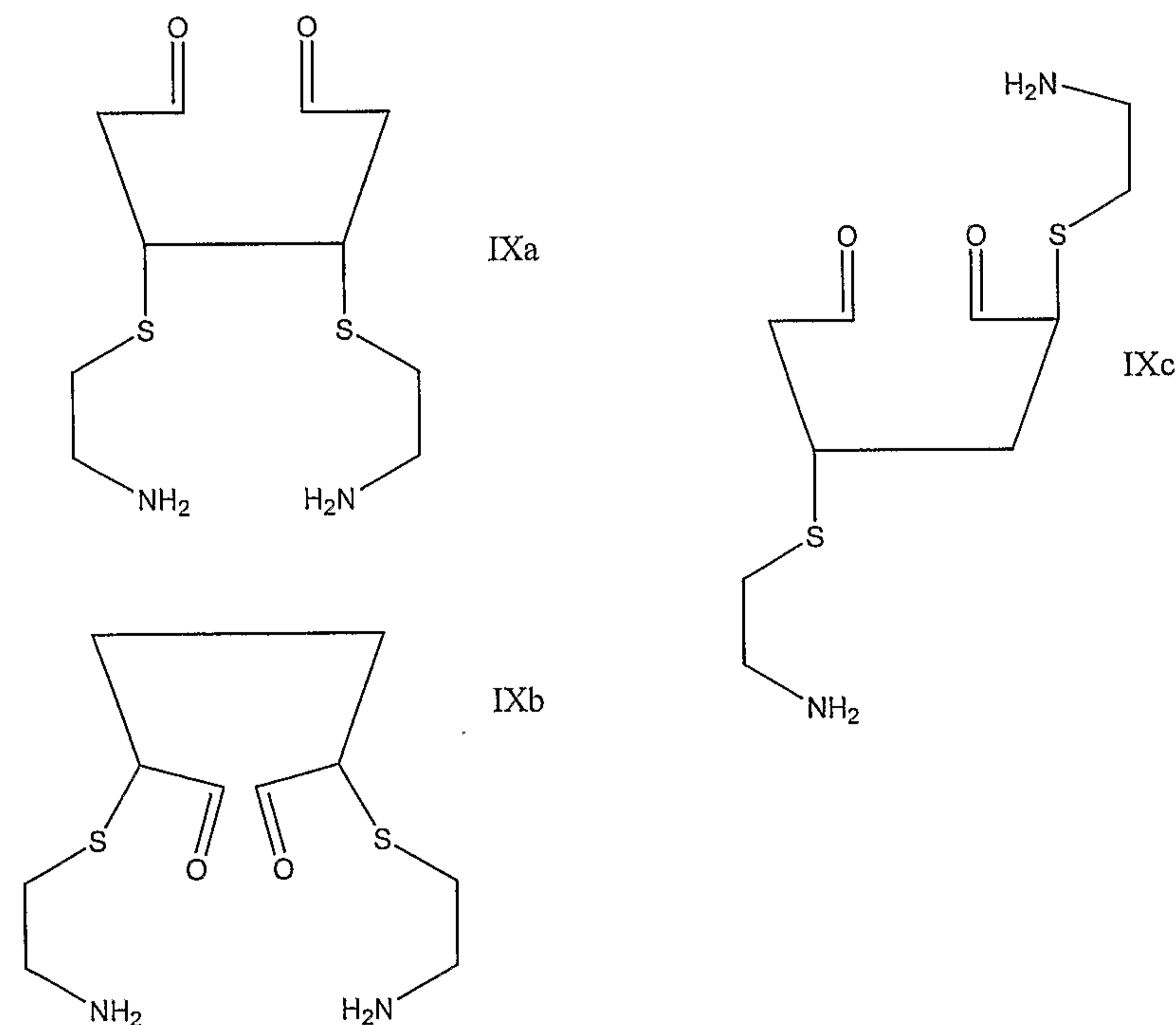

may be prepared by displacement of the iodo or other appropriate leaving groups of an oxidized cyclodextrin monomer precursor disubstituted with an iodo or other



appropriate leaving group with the amino or other nucleophilic group containing moiety such as, e.g.  $\text{HSCH}_2\text{CH}_2\text{NH}_2$  (or a di-nucleophilic molecule more generally represented by  $\text{HW}-(\text{CR}_1\text{R}_2)_n\text{-WH}$  wherein W, independently for each occurrence, represents O, S, or  $\text{NR}_1$ ;  $\text{R}_1$  and  $\text{R}_2$ , independently for each occurrence, represent H, 5 (un)substituted alkyl, (un)substituted aryl, (un)substituted heteroalkyl, (un)substituted heteroaryl) with an appropriate base such as a metal hydride, alkali or alkaline carbonate, or tertiary amine.

Alternatively, an oxidized diiodinated or diaminated cyclodextrin monomer precursor, as described above, may be prepared by oxidizing a cyclodextrin 10 monomer precursor to form an oxidized cyclodextrin monomer precursor and then diiodinating and/or diaminating the oxidized cyclodextrin monomer, as described above. As discussed above, the cyclodextrin moiety may be modified with other leaving groups other than iodo groups and other amino group containing functionalities. The oxidized diiodinated or diaminated cyclodextrin monomer 15 precursor may then be copolymerized with a comonomer A precursor, as described above, to form a linear oxidized cyclodextrin copolymer of the invention.

A linear oxidized cyclodextrin copolymer may also be further modified by attachment of at least one ligand to the copolymer. The ligand is as described above.

According to the invention, a linear cyclodextrin copolymer or linear 20 oxidized cyclodextrin copolymer may be attached to or grafted onto a substrate. The substrate may be any substrate as recognized by those of ordinary skill in the art. In another preferred embodiment of the invention, a linear cyclodextrin copolymer or linear oxidized cyclodextrin copolymer may be crosslinked to a polymer to form, respectively, a crosslinked cyclodextrin copolymer or a crosslinked oxidized 25 cyclodextrin copolymer. The polymer may be any polymer capable of crosslinking with a linear or linear oxidized cyclodextrin copolymer of the invention (e.g., polyethylene glycol (PEG) polymer, polyethylene polymer). The polymer may also be the same or different linear cyclodextrin copolymer or linear oxidized cyclodextrin copolymer. Thus; for example, a linear cyclodextrin copolymer may be 30 crosslinked to any polymer including, but not limited to, itself, another linear cyclodextrin copolymer, and a linear oxidized cyclodextrin copolymer. A

crosslinked linear cyclodextrin copolymer of the invention may be prepared by reacting a linear cyclodextrin copolymer with a polymer in the presence of a crosslinking agent. A crosslinked linear oxidized cyclodextrin copolymer of the invention may be prepared by reacting a linear oxidized cyclodextrin copolymer  
5 with a polymer in the presence of an appropriate crosslinking agent. The crosslinking agent may be any crosslinking agent known in the art. Examples of crosslinking agents include dihydrazides and disulfides. In a preferred embodiment, the crosslinking agent is a labile group such that a crosslinked copolymer may be uncrosslinked if desired.

10 A linear cyclodextrin copolymer and a linear oxidized cyclodextrin copolymer of the invention may be characterized by any means known in the art. Such characterization methods or techniques include, but are not limited to, gel permeation chromatography (GPC), matrix assisted laser desorption ionization-time of flight mass spectrometry (MALDI-TOF Mass spec),  $^1\text{H}$  and  $^{13}\text{C}$  NMR, light  
15 scattering and titration.

The invention also provides a cyclodextrin composition containing at least one linear cyclodextrin copolymer and at least one linear oxidized cyclodextrin copolymer of the invention as described above. Accordingly, either or both of the linear cyclodextrin copolymer and linear oxidized cyclodextrin copolymer may be  
20 crosslinked to another polymer and/or bound to a ligand as described above. Therapeutic compositions according to the invention contain a therapeutic agent and a linear cyclodextrin copolymer or a linear oxidized cyclodextrin copolymer, including crosslinked copolymers, of the invention. A linear cyclodextrin copolymer, a linear oxidized cyclodextrin copolymer and their crosslinked  
25 derivatives are as described above. The therapeutic agent may be any synthetic or naturally occurring biologically active therapeutic agent including those known in the art. Examples of suitable therapeutic agents include, but are not limited to, antibiotics, steroids, polynucleotides (e.g., genomic DNA, cDNA, mRNA, double-stranded RNA, and antisense oligonucleotides), plasmids, peptides, peptide  
30 fragments, small molecules (e.g., doxorubicin) and other biologically active macromolecules such as, for example, proteins and enzymes.



(g) Business Methods

Other aspects of the invention provides for certain methods of doing business. In particular, practicing the methods of the invention may enable novel therapeutic compositions and improved formulations thereof. This technical step, when combined with one or more additional steps, provides for novel approaches to conduct a pharmaceutical, or preferably a life-science business. For example, such therapeutic prepared by the method of the invention may be tested for efficacy as therapeutics in a variety of disease models, the potential therapeutic compositions then tested for toxicity and other safety-profiling before formulating, packaging and subsequently marketing the resulting formulation for the treatment of disease. Alternatively, the rights to develop and market such formulations or to conduct such steps may be licensed to a third party for consideration.

Accordingly, in certain embodiments, the present invention provides a method for conducting a pharmaceutical business, comprising:

- a. manufacturing a formulation or kit including a pharmaceutical composition of any of the compounds of claims 1-4; and
- b. marketing to healthcare providers the benefits of using the formulation or kit in the treatment of a disease or disorder.

In other embodiments, the present invention discloses a method for conducting a pharmaceutical business, comprising:

- a. providing a distribution network for selling a pharmaceutical composition of any of the compounds of claims 1-4; and
- b. providing instruction material to patients or physicians for using the preparation in the treatment of a disease or disorder.

In certain embodiments, the present invention provides a method for conducting a pharmaceutical business, comprising:

- a. determining an appropriate formulation and dosage of a pharmaceutical composition of any of the compounds of claims 1-4;

b. conducting therapeutic profiling of formulations identified in step (a), for efficacy and toxicity in animals; and

c. providing a distribution network for selling a preparation or preparations identified in step (b) as having an acceptable therapeutic profile.

5 An additional step of the embodiment comprises providing a sales group for marketing the preparation to healthcare providers.

In still other embodiments, the present invention provides a method for conducting a pharmaceutical business, comprising:

a. determining an appropriate formulation and dosage of a pharmaceutical composition of any of the compounds of claims 1-4; and

b. licensing, to a third party, the rights for further development and sale of the formulation.

### Exemplification

15 **Materials.**  $\beta$ -Cyclodextrin, " $\beta$ -CD", (Cerestar USA, Inc. of Hammond, IN) was dried *in vacuo* (<0.1 mTorr) at 120 °C for 12 h before use.

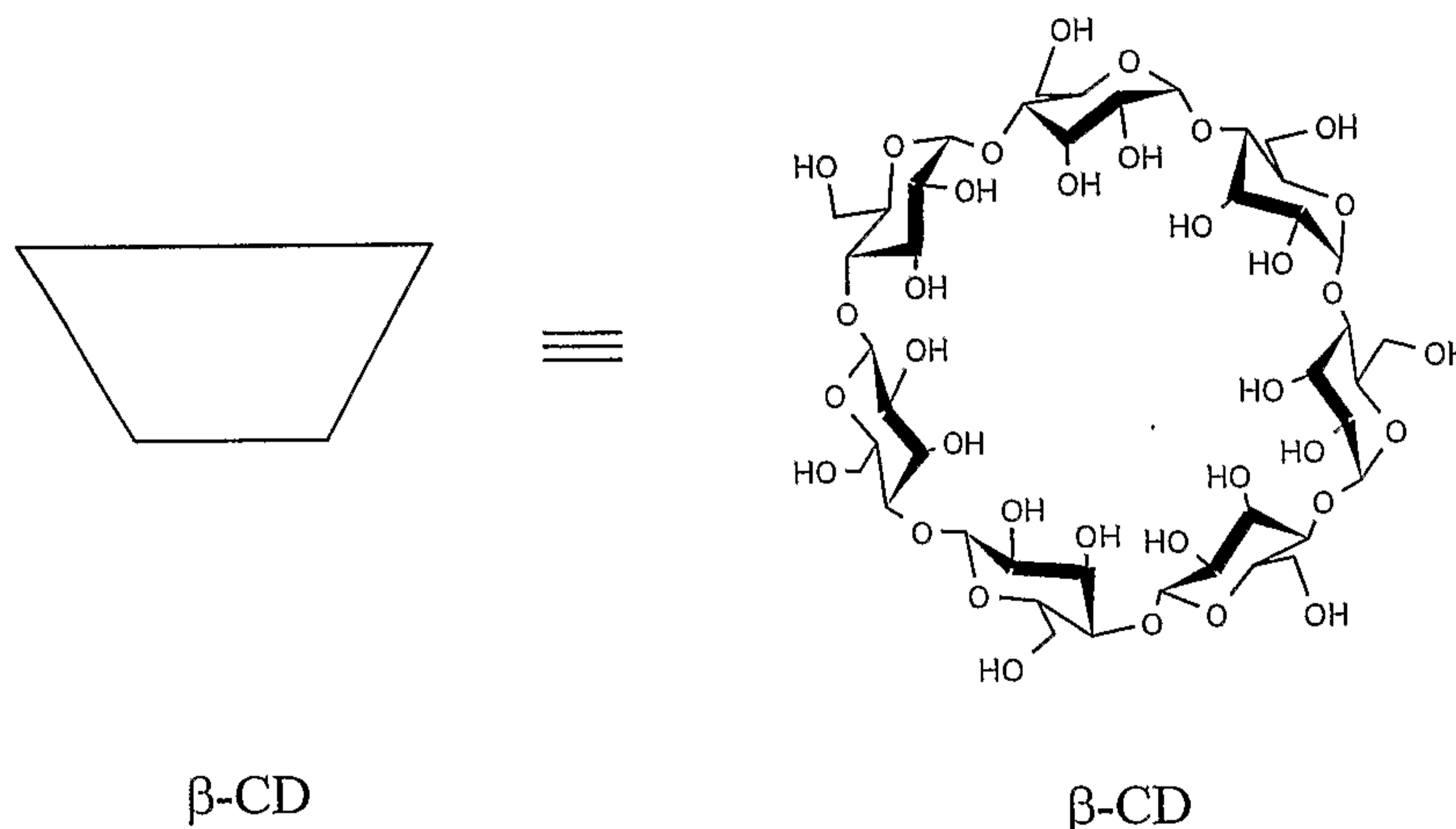

20 All the anhydrous solvents, HPLC grade solvents and other common organic solvents were purchased from commercial suppliers and used without further purification. Biphenyl-4,4'-disulfonyl chloride (Aldrich Chemical Company, Inc. of



Milwaukee, WI) was recrystallized from chloroform/hexanes. Potassium iodide was powdered with a mortar and pestle and dried in an oven at 200 °C. Polyethylene glycol dipropanoicsuccinimide (PEG-DiSPA, MW 3400), polyethylene glycol dibutanoicsuccinimide (PEG-DiSBA, MW 3400), and polyethylene glycol dibenzotrizolecarbonate (PEG-DiBTC, MW 3400) were purchased from Nektar (Huntsville, AL). Polyethylene glycol di-*p*-nitrophenolcarbonate (PEG-DiNPC, MW 3400) was acquired from Sigma (St. Louis, MO). CPT was purchased from Boehringer Ingelheim (Ingelheim, Germany). Human plasma was purchased from Sigma and reconstituted with DI water. Mouse plasma was prepared by centrifuge removal of blood cells of fresh blood samples collected from BALB/C female mice (Charles River). 6<sup>A</sup>,6<sup>D</sup>-diiodo-6<sup>A</sup>,6<sup>D</sup>-dideoxy- $\beta$ -cyclodextrin (CDDI, Scheme 2) was synthesized according to previous reported procedure by Hwang et. al (Bioconjugate Chem. 12, 280-290). Deionized water (18-M $\Omega$ -cm) was obtained by passing in-house deionized water through a Barnstead E-pure purification system. NMR spectra were recorded on a Bruker AMX 500 MHz or a Varian 300 MHz spectrometer. Mass spectral (MS) analysis was performed using either an electrospray mass spectrometer equipped with LCQ ion trap (Thermo Finnigan) and fitted with an electrospray ionization source or a MALDI-TOF mass spectrometer (Voyager DE-PRO, Applied Biosystems). MWs of the polymer samples were analyzed on a GPC system equipped with a Hitachi L-6200 Intelligent Pump, an Anspec RI detector (ERC-7512, Erma, Inc.), a Precision Detectors DLS detector (PD 2020), and double gel permeation columns (PL-aquagel-OH-40 8  $\mu$ m 300 mm  $\times$  7.5 mm, Polymer Laboratory) calibrated using polyethylene glycol standard and eluded using PBS (1 $\times$ ) at a concentration of 20-50 mg/mL and at a 0.7 mL/min flow rate at ambient temperature. CD derivatives were analyzed with a C-18 reverse phase column on a HPLC system equipped with an UV detector (System Gold 168 Detector, Beckman Coulter) and an evaporative light scattering (ELS) detector (Sedex 75, Sedere, France). CPT, CPT derivatives, and polymer-CPT conjugates were analyzed on HPLC systems with a C-18 reverse phase column (HIRPB-4438, 4.6  $\times$  150 mm, Richard Scientific) equipped with a fluorescence detector (FD-500, GTI/Spectro Vision, Groton Technology, Inc.) using a gradient of potassium phosphate buffer

(pH 4.1) and acetonitrile. Excitation and emission wavelengths of the fluorescence detector were set at 370 nm and 440 nm, respectively.

- 5 **Example 1:** Biphenyl-4,4'-disulfonyl-A,D-Capped  $\beta$ -Cyclodextrin, **1** (Tabushi et al. *J. Am. Chem. Soc.* **106**, 5267-5270 (1984))

Scheme XV

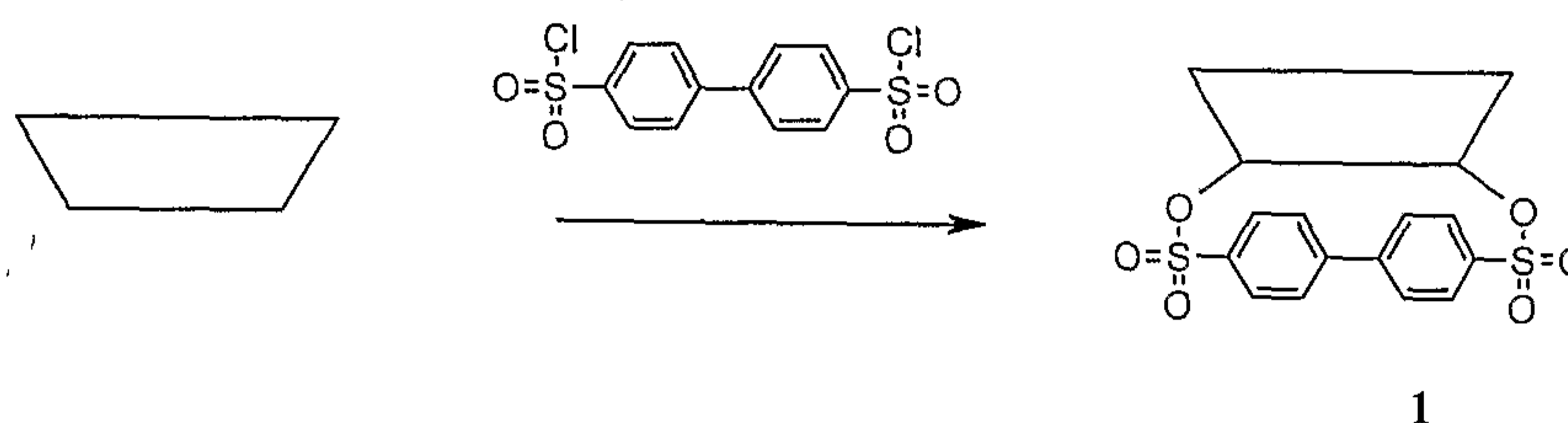

- 10 A 500 mL round bottom flask equipped with a magnetic stirbar, a Schlenk adapter and a septum was charged with 7.92 g (6.98 mmol) of dry  $\beta$ -cyclodextrin and 250 mL of anhydrous pyridine (Aldrich Chemical Company, Inc.). The resulting solution was stirred at 50 °C under nitrogen while 2.204 g (6.28 mmol) of biphenyl-4,4'-disulfonyl chloride was added in four equal portions at 15 min intervals. After stirring at 50 °C for an additional 3 h, the solvent was removed *in vacuo* and the residue was subjected to reversed-phase column chromatography using a gradient elution of 0-40% acetonitrile in water. Fractions were analyzed by high performance liquid chromatography (HPLC) and the appropriate fractions were combined. After removing the bulk of the acetonitrile on a rotary evaporator, the resulting aqueous suspension was lyophilized to dryness. This afforded 3.39 g (38%) of **1** as a colorless solid.

**Example 2:** 6<sup>A</sup>,6<sup>D</sup>-Diiodo-6<sup>A</sup>,6<sup>D</sup>-Dideoxy- $\beta$ -cyclodextrin, **2** (Tabushi et al. *J. Am. Chem.* **106**, 4580-4584 (1984))

Scheme XVI

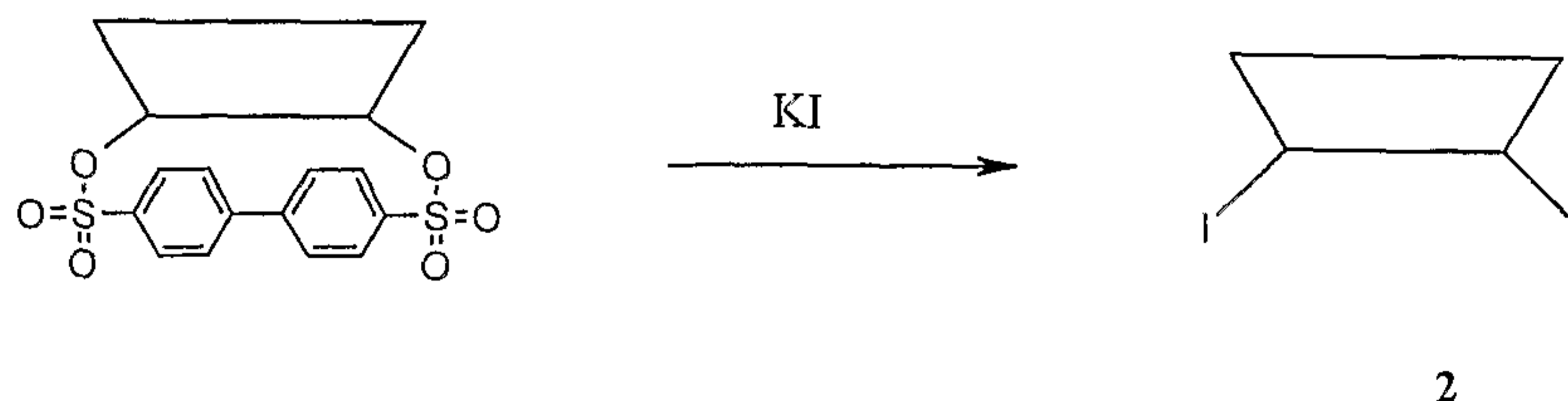

25



A 40 mL centrifuge tube equipped with a magnetic stirbar, a Schlenk adapter and a septum was charged with 1.02 g (7.2 mmol) of **1**, 3.54 g (21.3 mmol) of dry, powdered potassium iodide (Aldrich) and 15 mL of anhydrous

5 N,N-dimethylformamide (DMF) (Aldrich). The resulting suspension was stirred at 80 °C under nitrogen for 2 h. After cooling to room temperature, the solids were separated by filtration and the supernatant was collected. The solid precipitate was washed with a second portion of anhydrous DMF and the supernatants were combined and concentrated *in vacuo*. The residue was then dissolved in 14 mL of

10 water and cooled in an ice bath before 0.75 mL (7.3 mmol) of tetrachloroethylene (Aldrich) was added with rapid stirring. The precipitated product was filtered on a medium glass frit and washed with a small portion of acetone before it was dried under vacuum over P<sub>2</sub>O<sub>5</sub> for 14 h. This afforded 0.90 g (92%) of **2** as a white solid.

15 **Example 3:** 6<sup>A</sup>,6<sup>D</sup>-Bis-(2-aminoethylthio)-6<sup>A</sup>,6<sup>D</sup>-dideoxy-β-cyclodextrin, **3** (Tabushi, I; Shimokawa, K; Fugita, K. *Tetrahedron Lett.* **1977**, 1527-1530)

Scheme XVII

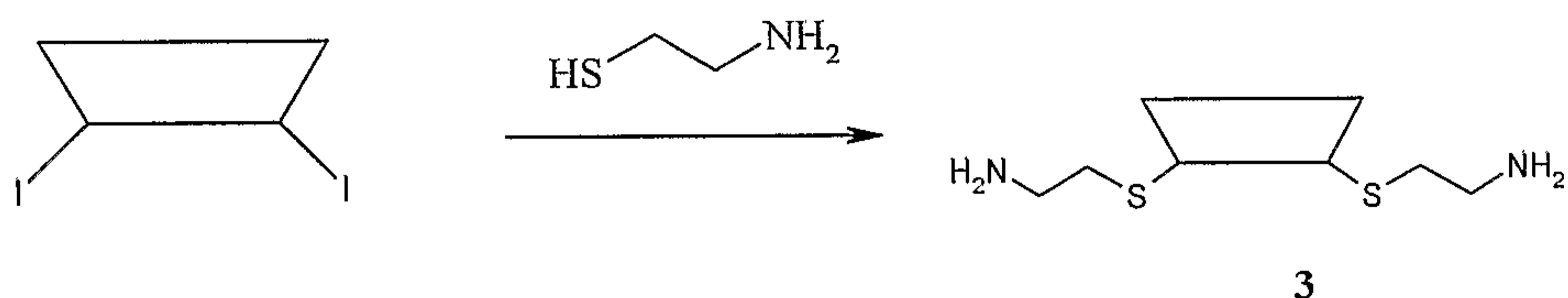

20 A 25 mL Schlenk flask equipped with a magnetic stirbar and a septum was charged with 0.91 mL (7.37 mmol) of a 0.81 M solution of sodium 2-aminoethylthiolate in ethanol. (Fieser, L.F.; Fieser, M. *Reagents for Organic Synthesis*; Wiley: New York, 1967; Vol. 3, pp.265-266). The solution was evaporated to dryness and the solid was redissolved in 5mL of anhydrous DMF

25 (Aldrich). 6<sup>A</sup>,6<sup>D</sup>-Diiodo-6<sup>A</sup>,6<sup>D</sup>-dideoxy-β-cyclodextrin (**2**) (100mg, 7.38 x 10<sup>-5</sup> mol) was added and the resulting suspension was stirred at 60 °C under nitrogen for 2 h. After cooling to room temperature, the solution was concentrated *in vacuo* and the residue was redissolved in water. After acidifying with 0.1 N HCl, the solution was applied to a Toyopearl SP-650M ion-exchange column (NH<sub>4</sub><sup>+</sup> form) and the product

30 was eluted with a 0 to 0.4 M ammonium bicarbonate gradient. Appropriate fractions

were combined and lyophilized to dryness. This afforded 80mg (79%) of **3** as a white powder.

Alternative Synthesis of dicysteamine  $\beta$ -CD **3**.

5 To a solution of 4.69g (3.17 mmol) of **2** in 100 mL of degassed water was added 0.489 g (6.34 mmol) of freshly sublimed cysteamine. The solution was stirred under reflux for 2 h. After cooling to room temperature and acidifying with 1 N HCl, the solution was applied to a Toyopearl SP-650M ion-exchange column (NH<sub>4</sub><sup>+</sup> form) and the product was eluted with a 0 to 0.2 M ammonium bicarbonate  
10 gradient. Appropriate fractions were combined and lyophilized to dryness. This procedure gave 1.87 g (39% yield) of a white solid. The solid was characterized by TLC (silica gel, *n*-PrOH-AcOEt-H<sub>2</sub>O-NH<sub>3</sub>aq 5/3/3/1, detection by ninhydrin) and exhibited a major spot corresponding to **3**. Matrix-assisted laser  
desorption/ionization (MALDI) time-of flight (TOF) mass spectrum was recorded  
15 on 2 meter ELITE instrument supplied by PerSeptive Biosystems, Inc. MALDI-TOF *m/z* calcd for **3**: 1252, found: 1253.5 [M+H]<sup>+</sup>, 1275.5 [M+Na]<sup>+</sup>, 1291.4 [M+K]<sup>+</sup>.  
<sup>13</sup>C NMR (Bruker 500 MHz, D<sub>2</sub>O)  $\delta$  ppm: 32.1 (S-CH<sub>2</sub>) and 38.8 (CH<sub>2</sub>-NH<sub>2</sub>), 32.9 (C6 adjacent to S), 60.2 (C6 adjacent to OH), 70.8, 71.4, 72.5 (C2, C3, C5), 81.8 (C4), 101.7 (C1).

20 **Example 4:** 6<sup>A</sup>,6<sup>D</sup>-Bis-(2-amino-2-carboxylethylthio)-6<sup>A</sup>,6<sup>D</sup>-dideoxy- $\beta$ -cyclodextrin, **4** (CD-BisCys)

Scheme XVIII

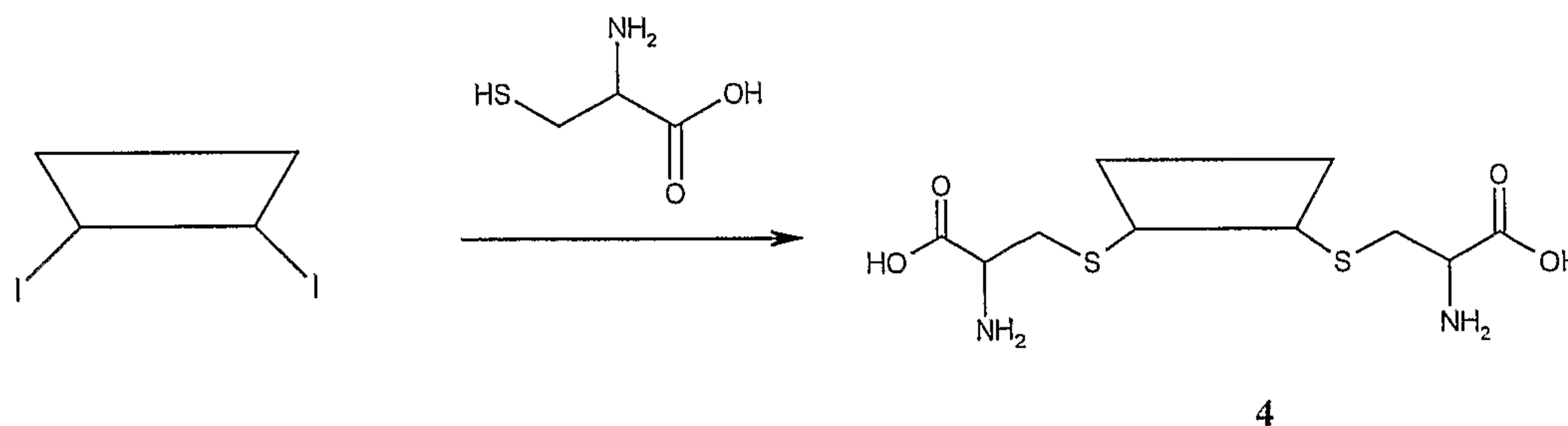

25 167 mL of 0.1 M sodium carbonate buffer were degassed for 45 minutes in a 500 mL 2-neck round bottom flask equipped with a magnetic stir bar, a condenser and septum. To this solution were added 1.96 g (16.2 mmol) of L-cysteine and 10.0



g (73.8 mmol) of diiodo, deoxy- $\beta$ -cyclodextrin **2**. The resulting suspension was heated at a reflux temperature for 4.5 h until the solution turned clear (colorless). The solution was then cooled to room temperature and acidified to pH 3 using 1N HCl. The product was precipitated by slow addition of acetone (3 times weight ratio of the solution). This afforded 9.0 g crude material containing CD-biscysteine (90.0%), unreacted cyclodextrin, CD-mono-cysteine and cystine. The resulting solid was subjected to anionic exchange column chromatography (SuperQ650M, Tosoh Bioscience) using a gradient elution of 0-0.4M ammonium bicarbonate. All fractions were analyzed by HPLC. The desired fractions were combined and the solvent was reduced to 100 mL under vacuum. The final product was either precipitated by adding acetone or by adding methanol (3 times weight ratio of the solution). **4** was obtained in 60-90% yield.  $^1\text{H}$  NMR ( $\text{D}_2\text{O}$ )  $\delta$  5.08 (m, 7H, CD-2-CH), 3.79-3.94 (m, 30H, CD-3,4-CH, CD- $\text{CH}_2$ , Cys-CH), 3.49-3.62 (m, 14H, CD-5, 6-CH), 2.92-3.30(m, 4H, Cys- $\text{CH}_2$ ).  $^{13}\text{C}$  NMR ( $\text{D}_2\text{O}$ )  $\delta$  172.3, 101.9, 83.9, 81.6, 81.5, 73.3, 72.2, 72.0, 60.7, 54.0, 34.0, 30.6. ESI/MS ( $m/z$ ): 1342 [ $\text{M}$ ] $^+$ , 1364 [ $\text{M} + \text{Na}$ ] $^+$ . Purity of **4** was confirmed by HPLC.

**Example 5:** 6<sup>A</sup>,6<sup>D</sup>-Bis-(carboxymethylthio)-6<sup>A</sup>,6<sup>D</sup>-dideoxy- $\beta$ -cyclodextrin, **5** (CDDM)

20 Scheme XIX

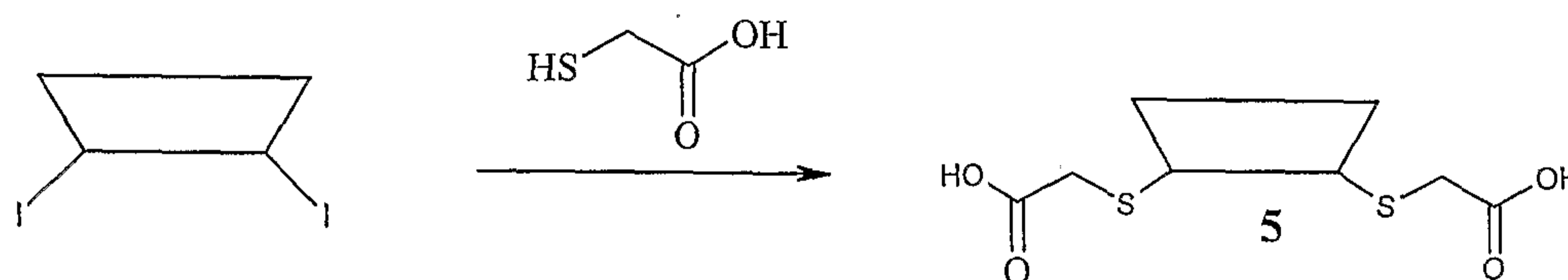

A 50 mL of 0.1 M sodium carbonate solution was degassed for 2 h in a 100 mL 3-neck round bottom flask equipped with a magnetic stir bar, a condenser and septa. Mercaptoacetic acid (0.46 mL, 6.64 mmol) was syringed into the flask and pH of the solution was adjusted to 9.3 with 1N sodium hydroxide. To this resulting solution was added 3.00 g (2.21 mmol) of di-iodo- $\beta$ -cyclodextrin **2** and heated at 80 °C for an hour. The solution temperature was increased 10 °C every hour until it reached 100 °C. After 3 h. at the reflux temperature, the clear colorless solution was cooled to room temperature and acidified to pH 3.5 using 1 N HCl. The crude

product was crashed out by slow addition of acetone (3 times weight ratio of the solution). The resulting solid was subjected to anionic exchange column chromatography using a gradient elution of 0-0.4 M ammonium bicarbonate solution. This afforded 1.8 g (63.4%) of **5** as a colorless solid. ESI/MS ( $m/z$ ): 1281 [M]<sup>-</sup>. Purity of this compound was confirmed with HPLC.

**Example 6: CD-Bis(Glutamic acid- $\gamma$ -Benzyl ester) **6****

Scheme XX

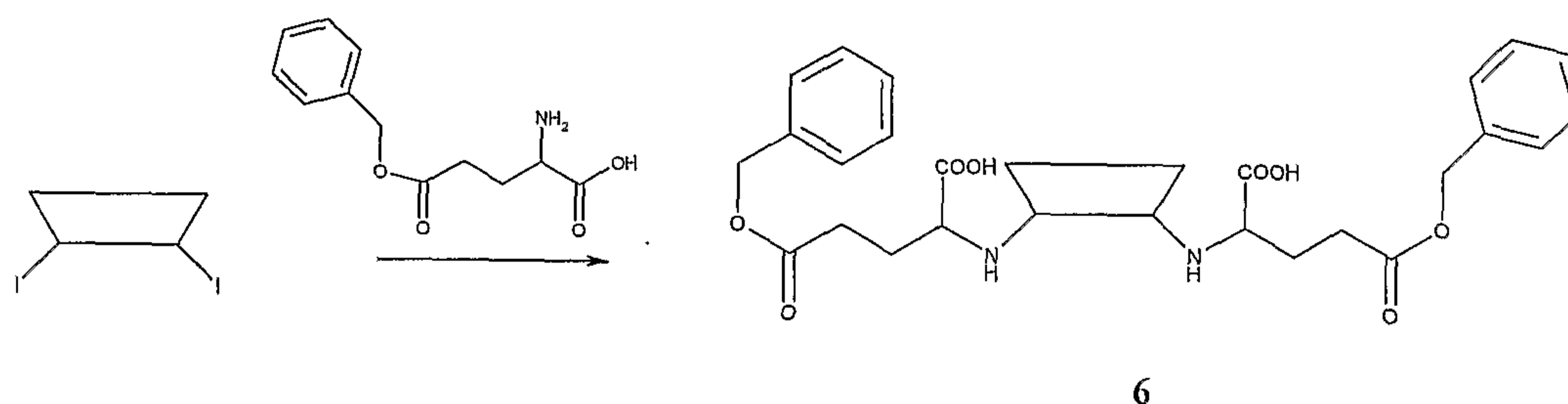

10

A 50 mL round bottom flask equipped with a magnetic stirbar and a condenser and a septum was charged with 0.101 g (0.425 mmol) of H-Glu(OBzl)-OH and 0.15 g (0.106 mmol) of dio-iodo  $\beta$  cyclodextrin **2** in 5 mL of degassed 0.1 M sodium carbonate solution. The solution mixture was heated at 100 °C for 2 h. The solution was then cooled to room temperature and acidified to pH 4 before dialyzing in MWCO 500 membranes for 24 h. The yield of **6** was 0.142 g (83.6 %).

15

**Example 7 CD-BisLys(Z) **7****

Scheme XXI

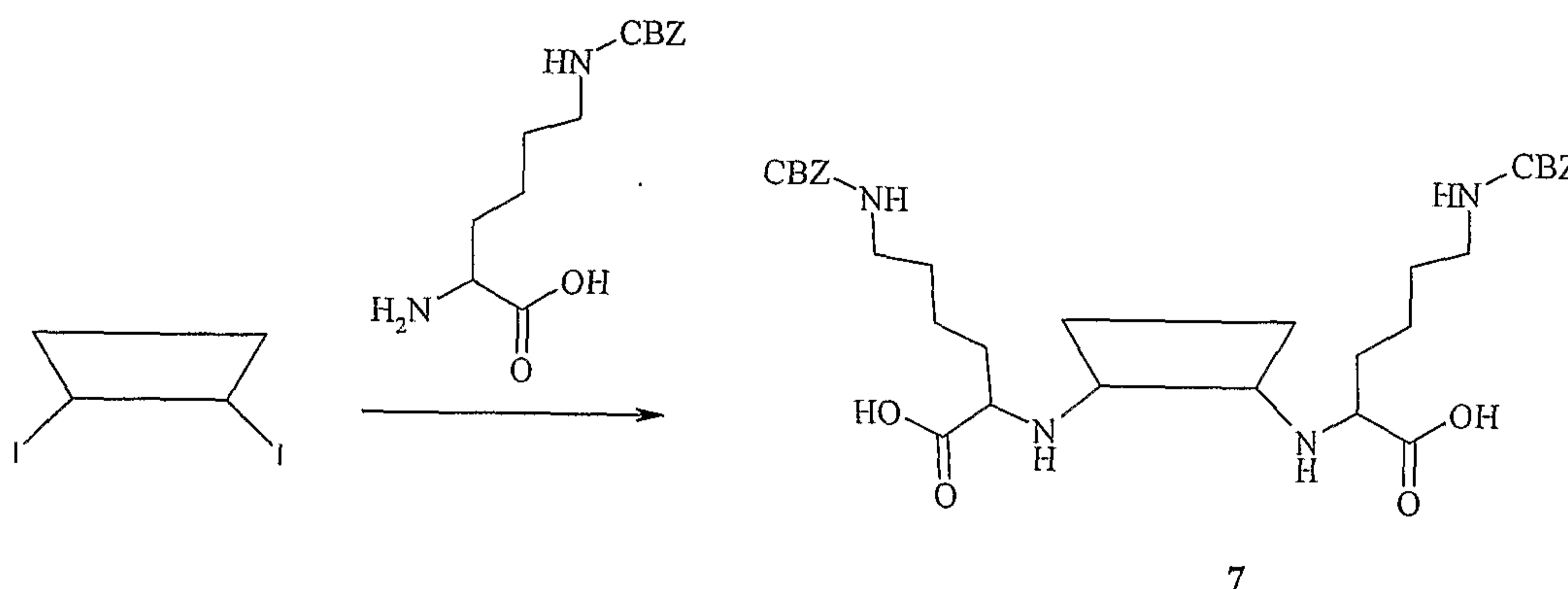

20



A 50 mL round bottom flask equipped with a magnetic stirbar and a condenser and a septum was charged with 0.124 g (0.443 mmol) of H-Lysine(Z)-OH and 0.15 g (0.111 mmol) of di-iodo- $\beta$ -cyclodextrin **2** in 5 mL of degassed 0.1M sodium carbonate solution. The solution mixture was heated at 100 °C for 4 h. The solution was then filtered and the pH of the filtrate is adjusted to 8.5 before dialyzing in MWCO 500 membranes for 24 h. The yield of **7** was 0.124 g (68.9%).

**Example 8:** Synthesis of  $\beta$ -cyclodextrin-Tosylate, **8** (Melton, L.D., and Slessor, K.N., *Carbohydrate Research*, 18, p. 29 (1971))

Scheme XXII

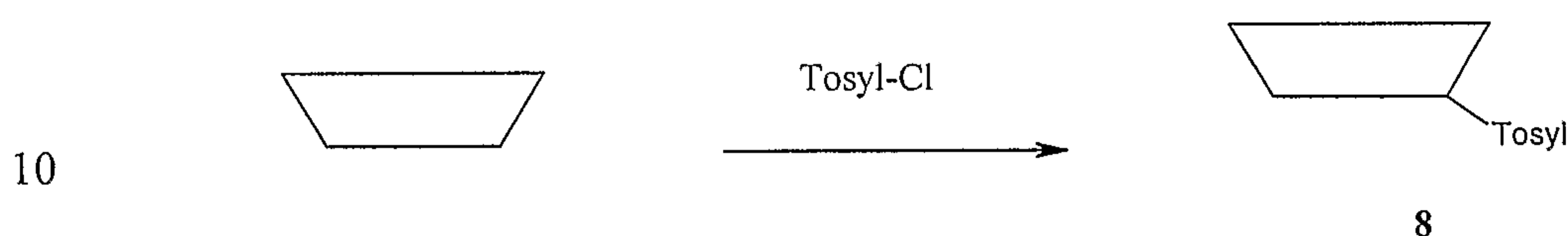

A 500 mL round-bottom flask equipped with a magnetic stirbar, a vacuum adapter and a septum was charged with a solution of dry  $\beta$ -cyclodextrin (8.530 g, 7.51 mmol) and 200 mL of dry pyridine. The solution was cooled to 0 °C before 1.29 g (6.76 mmol) of tosyl chloride was added. The resulting solution was allowed to warm to room temperature overnight. The pyridine was removed as much as possible *in vacuo*. The resulting residue was then recrystallized twice from 40 mL of hot water to yield 7.54 (88%) of a white crystalline solid **8**.

15

20 **Example 9:** Synthesis of Iodo- $\beta$ -cyclodextrin, **9**

Scheme XXIII

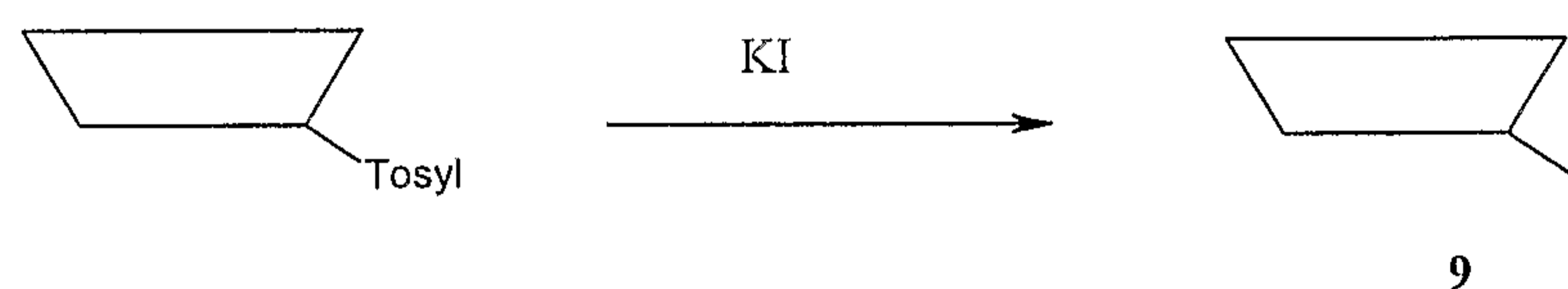

A round bottom flask with a magnetic stirbar and a Schlenk adapter is charged with **8**, 15 equivalents of potassium iodide, and DMF. The resulting mixture is heated at 80 °C for 3 h, after which the reaction is allowed to cool to room temperature. The mixture is then filtered to remove the precipitate and the filtrate evaporated to dryness and redissolved in water at 0 °C. Tetrachloroethylene

25

is added and the resulting slurry stirred vigorously at 0 °C for 20 minutes. The solid **9** is collected on a medium glass frit, triturated with acetone and stored over P<sub>2</sub>O<sub>5</sub>.

**Example 10: Synthesis of Cysteamine-β-Cyclodextrin, 10**

5 Scheme XXIV

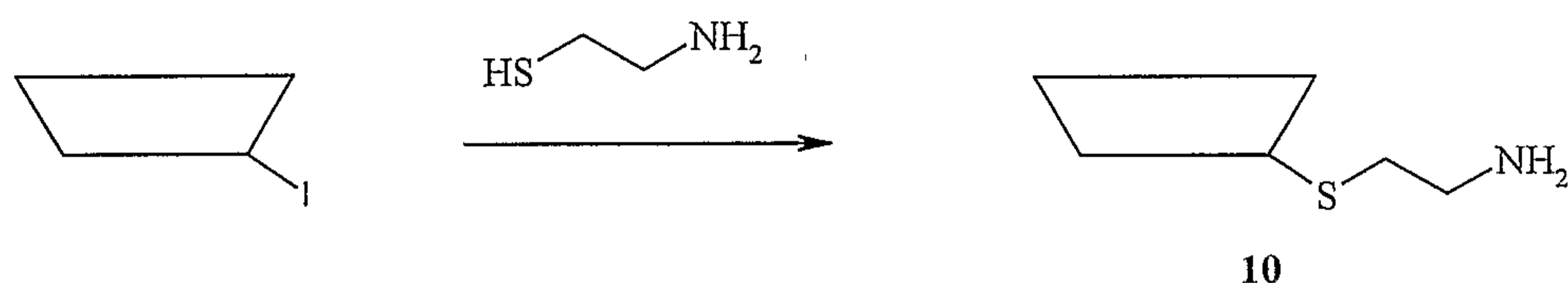

To a solution of **9** in 100 mL of degassed water is added 1 eq. of freshly sublimed cysteamine. The solution is stirred under reflux for 2 h. After cooled to room temperature and acidified with 1 N HCl, the solution is applied to a Toyopearl SP-650M ion-exchange column (NH<sub>4</sub><sup>+</sup> form) and the product is eluted with an ammonium bicarbonate gradient. Appropriate fractions are combined and lyophilized to dryness to yield **10**.

15 **Example 11: Synthesis of Gly-CPT 11** (Greenwald et al., *Bioorg. Med. Chem.*, **1998**, 6, 551-562)

Scheme XXV

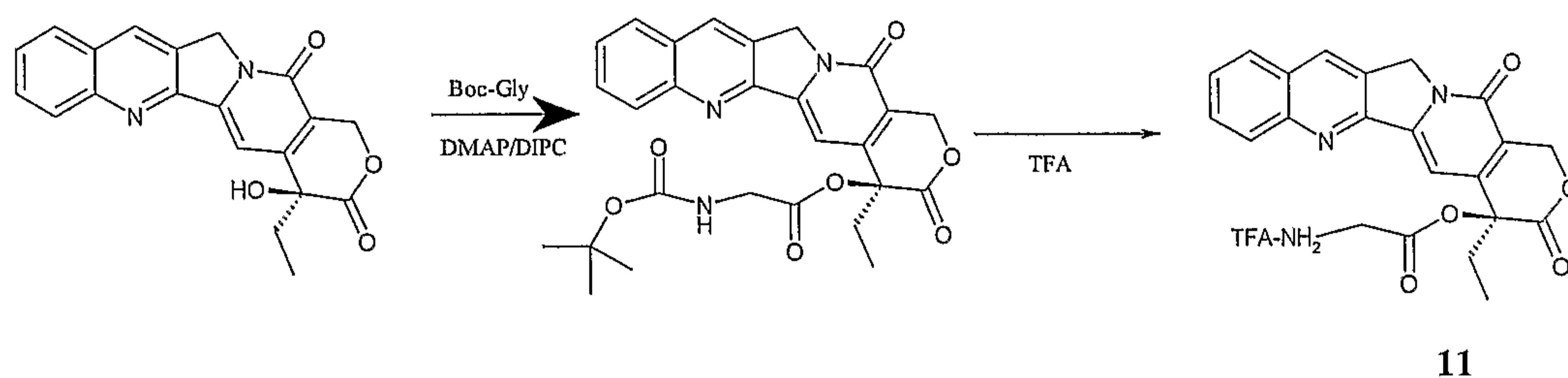

20

*t*-Boc-glycine (0.9 g, 4.7 mmol) was dissolved in 350 mL of anhydrous methylene chloride at room temperature, and to this solution were added DIPC (0.75 mL, 4.7 mmol), DMAP (382 mg, 3.13 mmol) and camptothecin (0.55g, 1.57 mmol) at 0 °C. The reaction mixture was allowed to warm to room temperature and left for 16 h. The solution was washed with 0.1 N HCl, dried and evaporated under reduced pressure to yield a white solid, which was recrystallized from

25



methanol to give camptothecin-20-ester of *t*-Boc-glycine:  $^1\text{H}$  NMR(DMSO- $d_6$ ) 7.5-8.8 (m), 7.3 (s), 5.5 (s), 5.3 (s), 4 (m), 2.1 (m), 1.6 (s), 1.3 (d), 0.9 (t).

Camptothecin-20-ester of *t*-Boc-glycine (0.595 g, 1.06 mmol) was dissolved in a mixture of methylene chloride (7.5 mL) and TFA (7.5 mL) and stirred at room temperature for 1 h. Solvent was removed and the residue was recrystallized from methylene chloride and ether to give 0.45 g of **11**.  $^1\text{H}$  NMR (DMSO- $d_6$ )  $\delta$ 7.7-8.5 (m); 7.2 (s), 5.6 (s), 5.4 (s), 4.4 (m), 2.2 (m), 1.6 (d), 1.0 (t),  $^{13}\text{C}$  NMR (DMSO- $d_6$ )  $\delta$ 168.6, 166.6, 156.5, 152.2, 147.9, 146.2, 144.3, 131.9, 130.6, 129.7, 128.8, 128.6, 128.0, 127.8, 119.0, 95.0, 77.6, 66.6, 50.5, 47.9, 30.2, 15.9, 7.9. ESI/MS ( $m/z$ ) expected 405; Found 406 (M+H).

### Example 12 Synthesis of GlyGlyGly-CPT **12**

#### Scheme XXVI

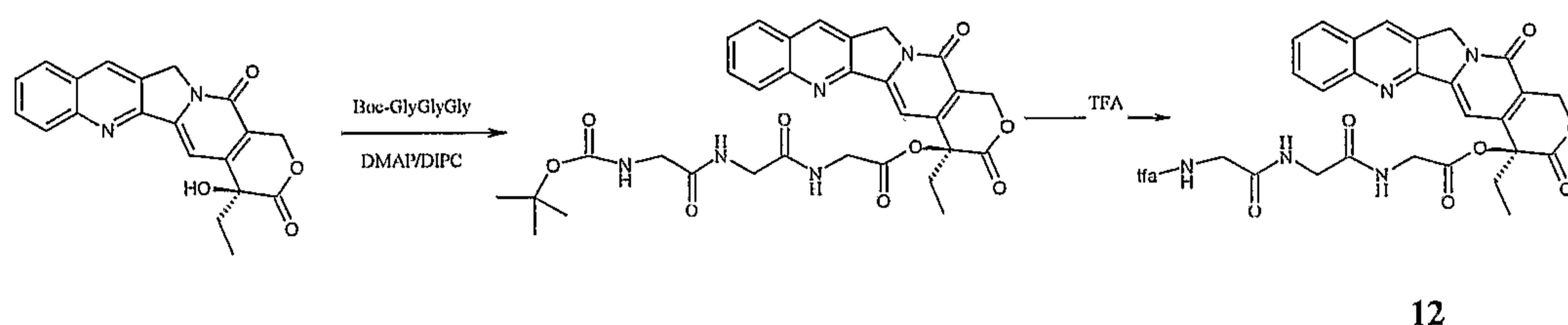

15

12

*t*-Boc-GlyGlyGly (1.359 g, 4.7 mmol) was dissolved in 350 mL of anhydrous methylene chloride at room temperature and to this solution were added DIPC (0.75 mL, 4.7 mmol), DMAP (382 mg, 3.13 mmol) and camptothecin (0.55g, 1.57 mmol) at 0 °C. The reaction mixture was allowed to warm to room temperature and left for 16 h. The solution was washed with 0.1 N HCl, dried and evaporated under reduced pressure to yield a white solid, which was recrystallized from methanol to give camptothecin-20-ester of *t*-Boc-GlyGlyGly:  $^1\text{H}$  NMR(DMSO- $d_6$ )  $\delta$  8.40 (s), 8.25 (d), 7.91 (d), 7.78 (m), 7.65 (t), 7.26 (s), 7.05 (br, s), 5.65 (d), 5.40 (d), 5.25 (s), 5.10 (br, s), 3.75-4.42 (m), 2.15-2.35 (m), 1.45 (s), 0.95 (t) Camptothecin-20-ester of *t*-Boc-GlyGlyGly (1.5 g, 1.06 mmol) was dissolved in a mixture of methylene chloride (10 mL) and TFA (10 mL) and stirred at room temperature for 1 h. Solvent was removed under vacuum and the residue was re-dissolved in methylene chloride. The solution was poured into ether to give instant precipitate

25

(yellow). The precipitate was filtered and washed with cold ether to give 1.31 g of **12**.  $^1\text{H NMR}$  ( $\text{DMSO-}d_6$ )  $\delta$  8.79 (s), 7.75-8.61 (m), 7.10 (s), 5.55 (s), 3.90-4.37 (m), 3.86 (s), 3.54 (s), 2.11-2.23 (m), 0.95 (t). ESI/MS ( $m/z$ ) expected 519; Found 520 (M+H).

5

#### Stability of CPT-Peptide ester bond

**11** and **12** were dissolved in PBS buffer (pH 7.4) at room temperature to prepare a solution about 500  $\mu\text{g/mL}$ . This solution was further diluted in 8.5%  $\text{H}_3\text{PO}_4$  to 10  $\mu\text{g/mL}$ . Hydrolysis rate was analyzed using HPLC equipped with a  $\text{C}_{18}$  RP (reverse phase) column and a fluorescence detector using a 50/50 (v/v) of acetonitrile/potassium phosphate buffer (pH 4.1). The peaks of **11** (or **12**) and the released CPT (lactone form) were integrated. The stability of the ester bond in aqueous solution is peptide-length dependant. Thus the drug release rate (hydrolysis rate) can be tuned by adjusting the peptide length. See Figure 2.

#### 15 Lactone Stability of CPT, **11** and **12** in Phosphate Buffered Saline (PBS)

CPT, **11** or **12** was dissolved in DMSO at 1  $\text{mg/mL}$  and then diluted to 1  $\mu\text{g/mL}$  with PBS (1 $\times$ , pH 7.4). 30  $\mu\text{L}$  of solution were injected into the HPLC at room temperature at selected time intervals. The peak area from the CPT lactone form of CPT, **11** or **12**) were integrated.

20 The rate of lactone ring opening for **11**, **12** and CPT were studied in PBS buffer (pH 7.4). Both **11** and **12** were very stable against ring-opening and no carboxylate forms of **11** and **12** were detected throughout the study (7 hours). On the other hand, more than 60% of the CPT lactone form was transformed to its carboxylate form in the same period of time. (See Fig. 3)

25

#### Example 13: Synthesis of Lys(BisCBZ)-CPT **13** Scheme XXVII



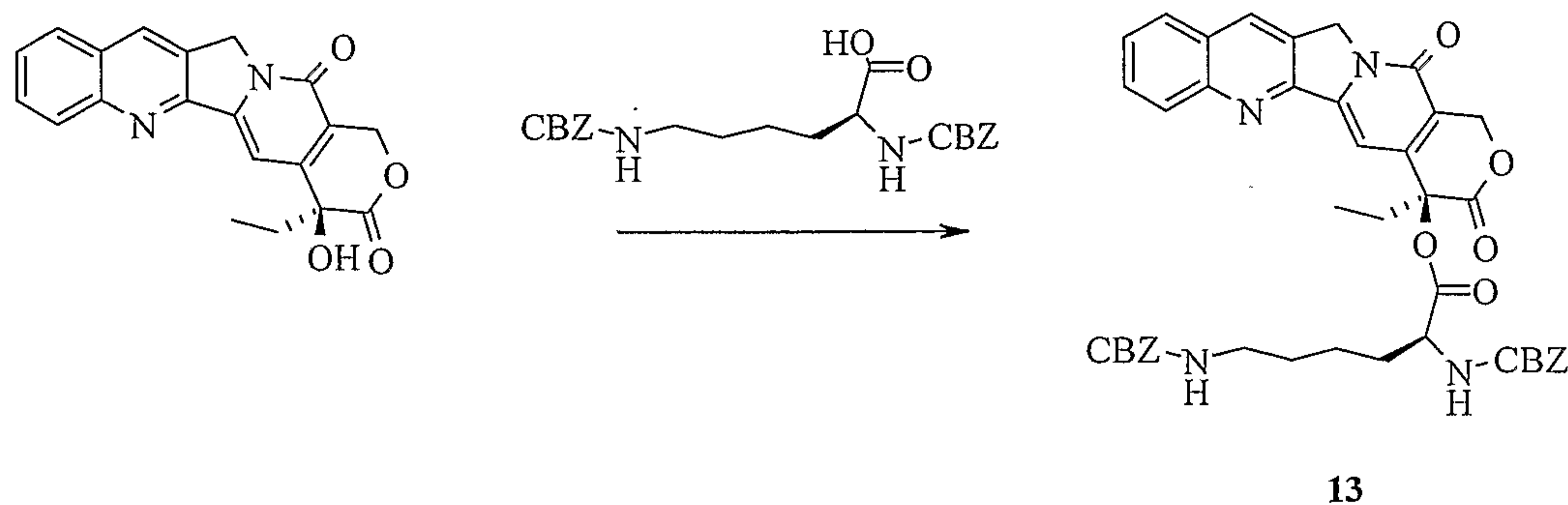

5 *N, N*-BisCBZ-Lysine (311 mg, 0.75 mmol) was dissolved in 56 mL of  
 anhydrous methylene chloride at room temperature. To this solution were added  
 DIPC (0.12 mL, 0.75 mmol), DMAP (0.61 mg, 0.5 mmol) and camptothecin (0.087  
 g, 0.25 mmol) at 0 °C. The reaction mixture was allowed to warm to room  
 temperature and left for 16 h. The solution was washed with 0.1 N HCl, dried and  
 evaporated under reduced pressure to yield a light yellow solid, which was  
 10 recrystallized from methanol to give camptothecin-20-ester of *N,N*-BisCBZ-Lys **13**.  
 Purification of **13** was satisfactory based on TLC and HPLC analysis.

Hydrolysis of **13** in aqueous solution is very slow and cannot be detected  
 using HPLC equipped with a UV detector. Hydrolysis rate of the ester bond of  
 CPT-peptide linker can be tuned not only by adjusting the length of peptide, as  
 15 shown in **Example 12**, but also by using different amino acid linked directly with  
 CPT's 20-OH.

The transformation of lactone form to carboxylate form of CPT and **13** were  
 also tested in PBS buffer. It was found that the transformation of lactone form to  
 carboxylate form of compound **13** was much slower than that of free CPT,  
 20 indicating that lactone form (drug active form) can be stabilized by forming an ester  
 with the -OH of CPT at its 20 position. (See Fig. 4)

#### **Example 14** Synthesis Lys-Gly-CPT **14**

25 **11** is dissolved in chloroform. *N, N*-DiBoc-Lys-NHS (1.0 eq) is added  
 followed by triethylamine (1.0 eq). The mixture is stirred at rt for 16 hours and  
 extracted twice with water and then dried with MgSO<sub>4</sub>. Solvent is removed under

high vacuum to yield N, N-DiBoc-Lys-Gly-CPT. To this compound is added a mixture of equal volume CH<sub>2</sub>Cl<sub>2</sub> and TFA and stirred at rt for 1 h. The solvent is then removed under vacuum. The residue is redissolved in CHCl<sub>3</sub>. Ether is added to the solution to crash out the product **14**. The precipitate is washed several times  
5 with ether and then dried under vacuum. It is purified using a silica gel column chromatography to yield **14** in pure TFA salt form.

**Example 15** Synthesis of Suc-Gly-CPT **15**

A solution of succinic anhydride is mixed with **11** (1 eq) in dry CHCl<sub>3</sub> in the presence of a catalytic amount of DMAP and DIEA (1 eq). The mixture is stirred at  
10 rt for 24 hours to yield **15**. **15** is purified by crystallization.

**Example 16** Synthesis of Glu-Suc-Gly-CPT **16**

**15** is converted to its NHS ester using traditional DCC/NHS method. The NHS ester of **15** is then reacted with glutamic acid (1.0 eq) in DMSO in the presence of triethylamine. The solution is added to ether to precipitate **16**. **16** is purified by  
15 crystallization.

**Example 17** Synthesis of Glu-Bis(GlyCPT) **17**

**11** and Boc-Glu(NHS)-NHS (0.4 eq) are mixed in CHCl<sub>3</sub> under argon before triethylamine (1 eq) is added to the mixture. The solution is stirred at rt for 16 h and  
20 then washed with acidic water. The organic layer is dried and then solvent is removed under vacuum. The resulting compound is purified using a silica gel column chromatography. The purified compound is then dissolved in an equal volume mixture of TFA and CH<sub>2</sub>Cl<sub>2</sub>. The mixture is stirred at rt for 1 h and then poured into ether. The precipitate **17** is washed with ether and dried under vacuum.

25

**Example 18** Synthesis of Cyclodextrin-Camptothecin **18**

Scheme XXVIII



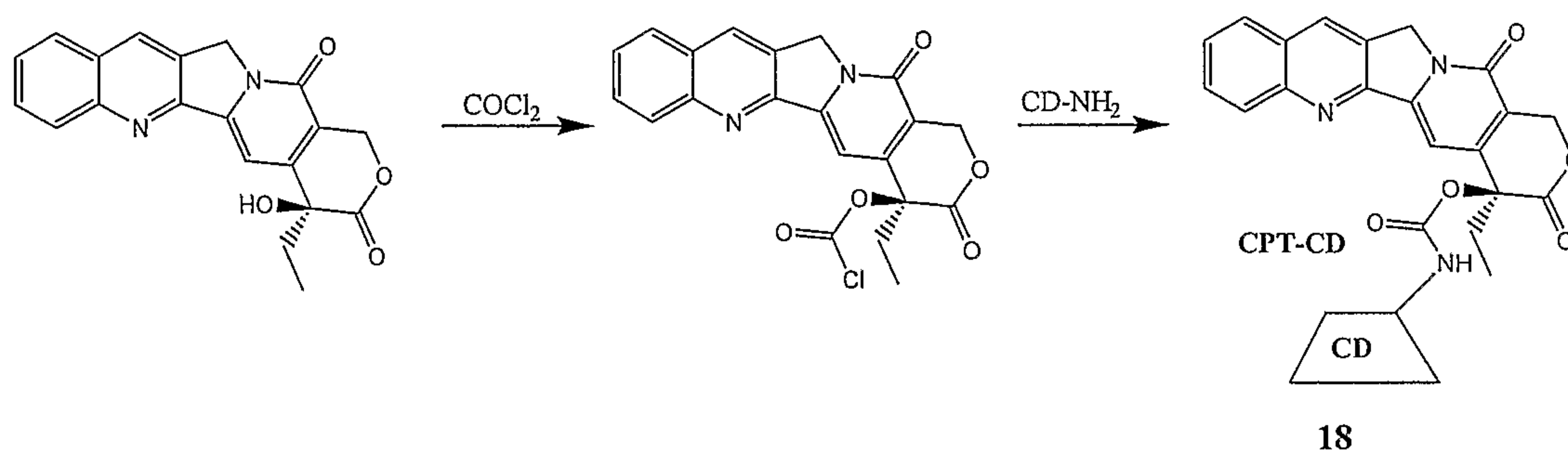

CPT (197 mg, 0.566 mmol) was vacuumed for 30 minutes. Dry chloroform  
 5 (100 mL) was added under argon. Phosgene (1.34 mL, 20% in toluene solution) was  
 added at 0 °C. Ice bath was removed and the solution was warmed up to room  
 temperature. Two hours later solvent was removed under high vacuum. Dry DMSO  
 (50 mL) was added to the residue, followed by 200 mg CD-NH<sub>2</sub> (Cyclodextrin  
 Technology, Inc.) and triethylamine (4 mL, excess). 16 hours later, the solution was  
 10 poured into 200 mL ether. Precipitate was washed with ether extensively and then  
 dried. 167 mg yellow powder (**18**) was obtained (62% yield). TLC analysis (silica  
 gel) of **18**: R<sub>f</sub> = 0 (developed with CHCl<sub>3</sub>/MeOH v/v = 5/1). TLC analysis of CPT:  
 R<sub>f</sub> = 0.65 (developed with CHCl<sub>3</sub>/MeOH v/v = 5/1). Solubility: >10 mg/mL in  
 15 water. This indicates that solubility of CPT in water can be substantially increased  
 when it is covalently attached to cyclodextrin molecule (free CPT solubility in water  
 < 0.004 mg/mL).

**Example 19.** Synthesis of CDDC-Dianhydride Copolymer **19, 21** and its CPT  
 conjugate **20, 22**  
 Scheme XXIX

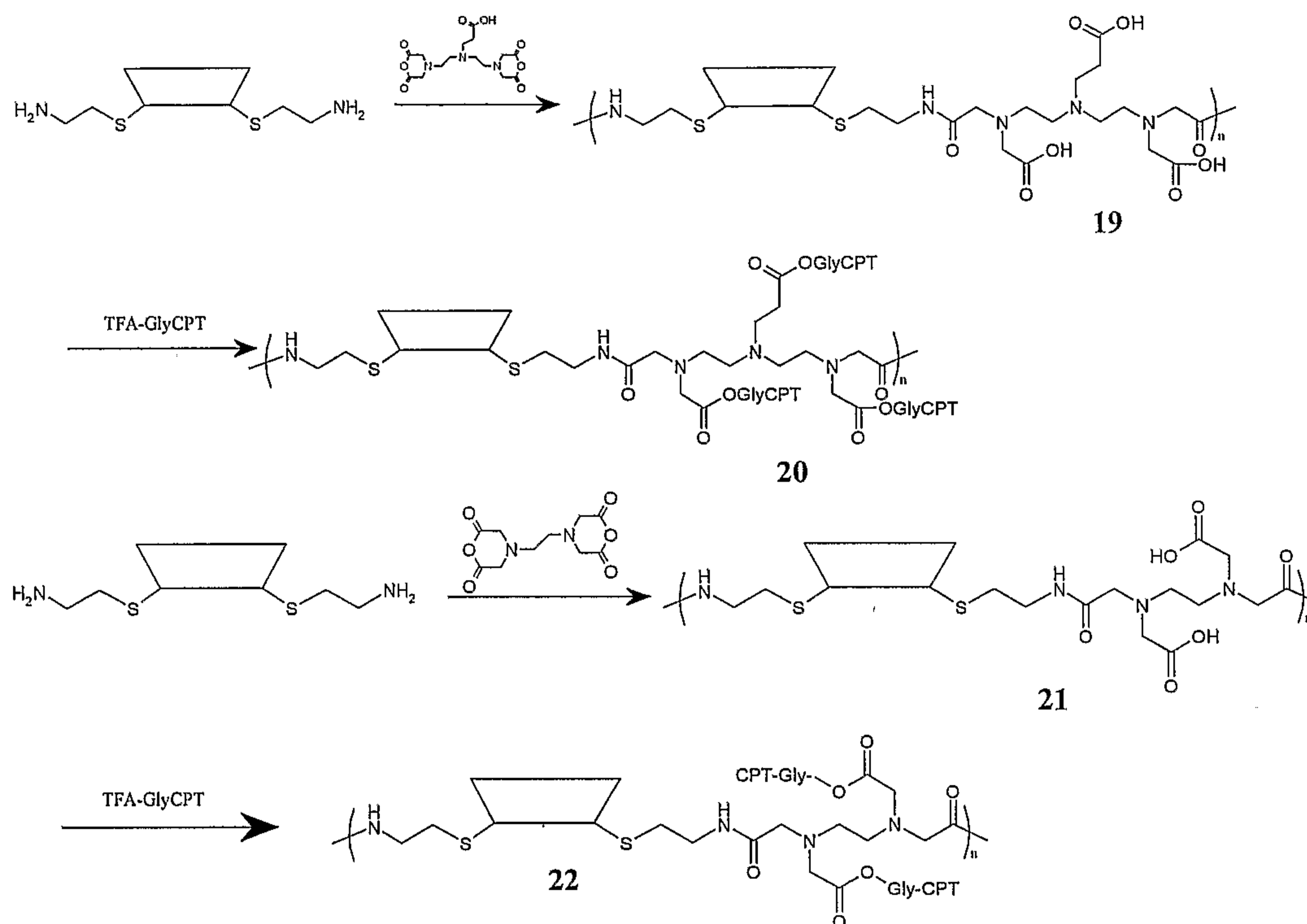

A: Ethylenediamine tetraacetic dianhydride (25.6 mg, 0.1 mmol) and CDDC  
 5 (3, 125.3 mg, 0.1 mmol) were dissolved in 2 mL of dry DMSO. The solution was heated at 50 °C for 72 h. Water was added to the mixture, followed by addition of 1 N NaOH to pH around 12. The polymer was dialyzed in 10,000 MWCO membrane for 24 h. Precipitation was observed in the dialysis membrane. The solid was removed and the remaining solution was dialyzed again in 10,000 MWCO  
 10 membrane for 24 h. A white powder **19** (75 mg) was obtained after lyophilization.

**11** is added to the polymer (**19**)/DMSO solution in the presence of EDC (2 eq), NHS (1 eq), and DIEA (1.0 eq). The solution is stirred for 16 h and then poured into ether. The precipitate is washed with CH<sub>2</sub>Cl<sub>2</sub> extensively until no free drug is observed in the washing solution. Compound **20** is obtained after drying under high  
 15 vacuum.

B: Diethylenetriamine pentaacetic dianhydride (8.5 mg, 0.024 mmol) and CDDC, **3** (30 mg, 0.024 mmol) were dissolved in 1-methyl-2-pyrrolidinone (2 mL).



The mixture was stirred at 64 °C for 4 days and then dialyzed in 10,000 MWCO membrane for 2 days. A white powder **21** (3 mg) was obtained after lyophilization.

**11** is added to the polymer (**21**)/DMSO solution in the presence of EDC (2 eq), NHS (1 eq), and DIEA (1.0 eq). The solution is stirred for 16 h and then precipitated in ether. The precipitate is washed with CH<sub>2</sub>Cl<sub>2</sub> extensively until no free drug is observed in the washing solution. Compound **22** is obtained after drying under high vacuum.

### Example 20 Synthesis of CCD-Cys Copolymer **23** and its CPT conjugate **24**

#### Scheme XXX

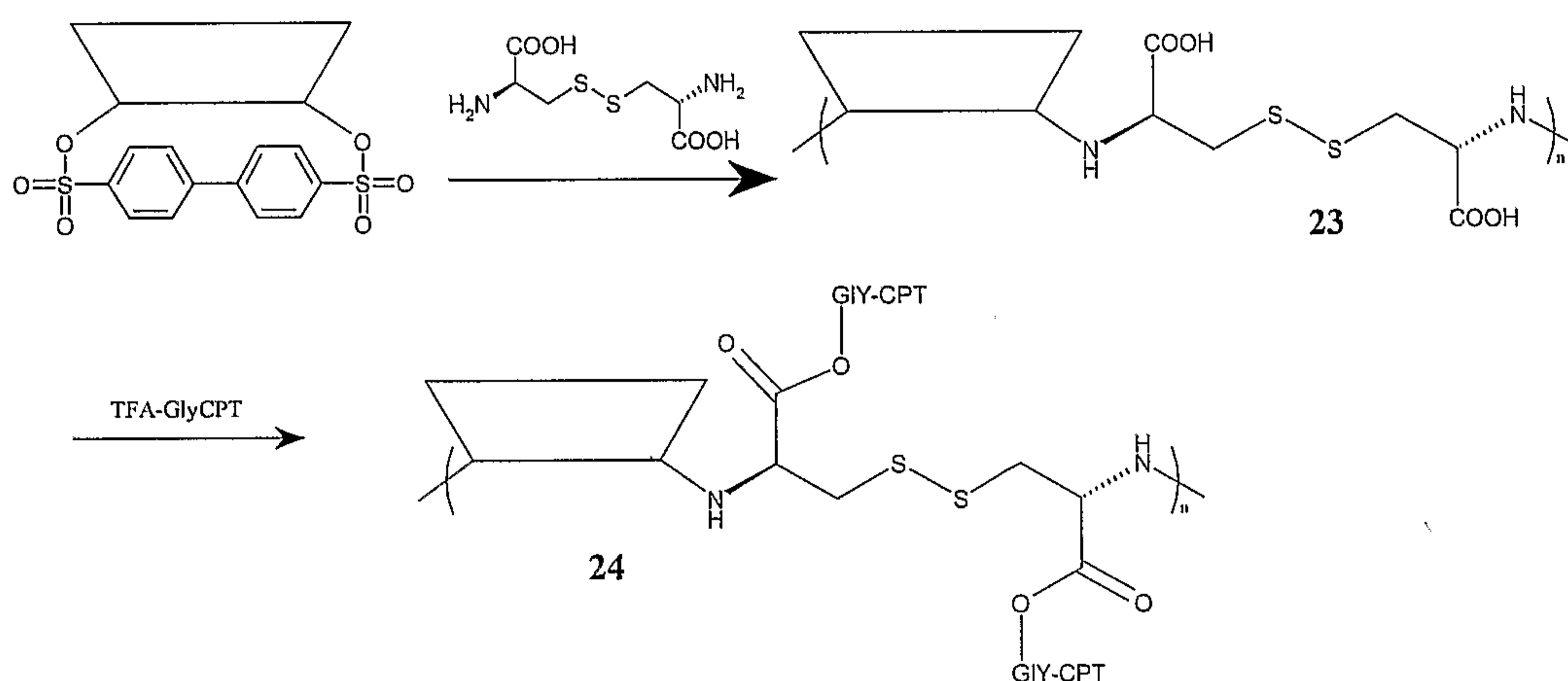

10

CCD **1** (141.3 mg, 0.1 mmol) and cystine (24 mg, 0.1 mmol) were dissolved in dry DMSO (0.3 mL) and pyridine (0.1 mL). The mixture was stirred under argon for overnight at 72 °C. Water (10 mL) was added. Precipitate was filtered and the filtrate was dialyzed in 10,000 MWCO membrane (Spectra/Por 7) for 48 h. A white powder **23** (8 mg) was obtained.

**11** is mixed with **23** in DMSO. EDC (2 eq), NHS (1 eq), and DIEA (1.0 eq) are added to the solution. The solution is stirred for 16 h and then precipitated with ether. The precipitate is washed with CH<sub>2</sub>Cl<sub>2</sub> extensively until no free drug is observed in the washing solution. Compound **24** is obtained after drying under high vacuum.

**Example 21** Synthesis of CD-BisGlu-Diamine Copolymer **25** and its CPT conjugate **26**

5 **Scheme XXXI**

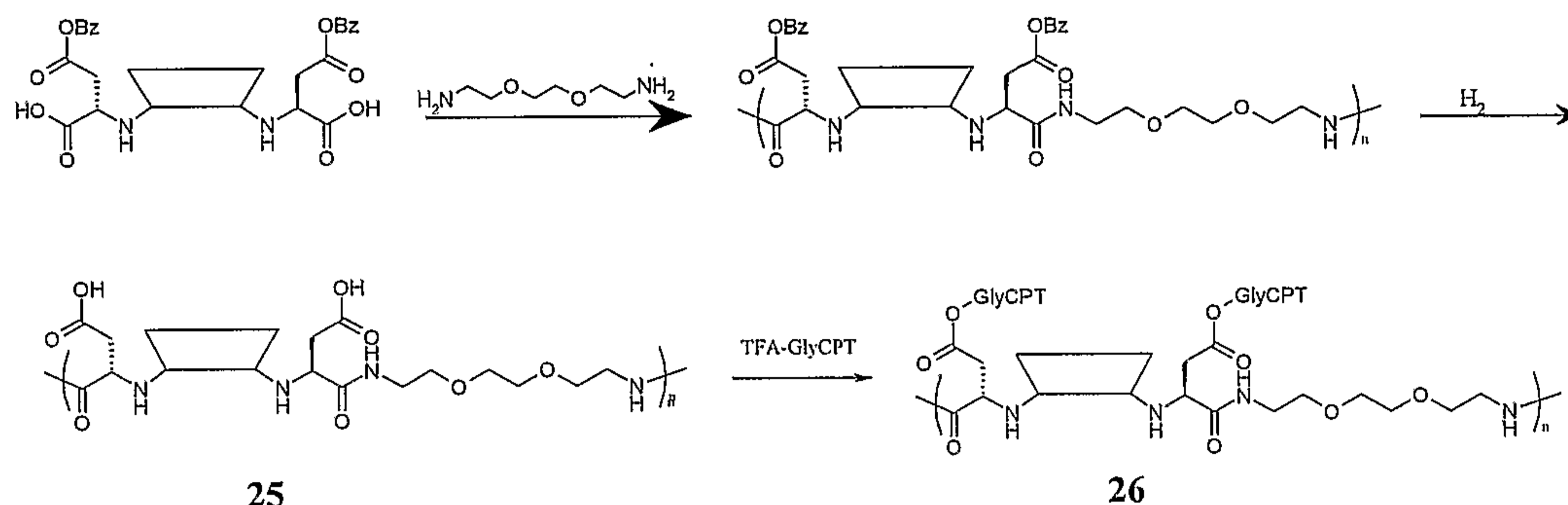

10 CD-Bis(Glutamic acid- $\gamma$ -Benzyl ester) **6** and ethyleneglycolbisethylamine are dissolved in dry DMSO. EDC (3 eq) and Sulfo-NHS (2 eq) are added to the mixture. The solution is stirred under argon for 2 days at rt. The solution is then transferred to a 10,000 MWCO dialysis membrane and dialyzed for 48 hours. After lyophilization a white powder is obtained. The solid is then dissolved in DMSO and methanol solvent mixture and treated with H<sub>2</sub> in the presence of 10% Pd/C catalyst  
15 for 24 hours. The solution is poured into ether to crash out the product. **25** is obtained after drying under vacuum.

**11** is mixed with **25** in DMSO solution. EDC (2 eq), NHS (1 eq), and DIEA (1.0 eq) are added to the solution. The solution is stirred for 16 hrs and then precipitated with ether. The precipitate is washed with CH<sub>2</sub>Cl<sub>2</sub> extensively until no  
20 free drug is observed in the washing solution. Compound **26** is obtained after drying under high vacuum.

**Example 22** Synthesis of CDDM-Lys(GlyCPT) Polymer **27**

25 **Scheme XXXII**



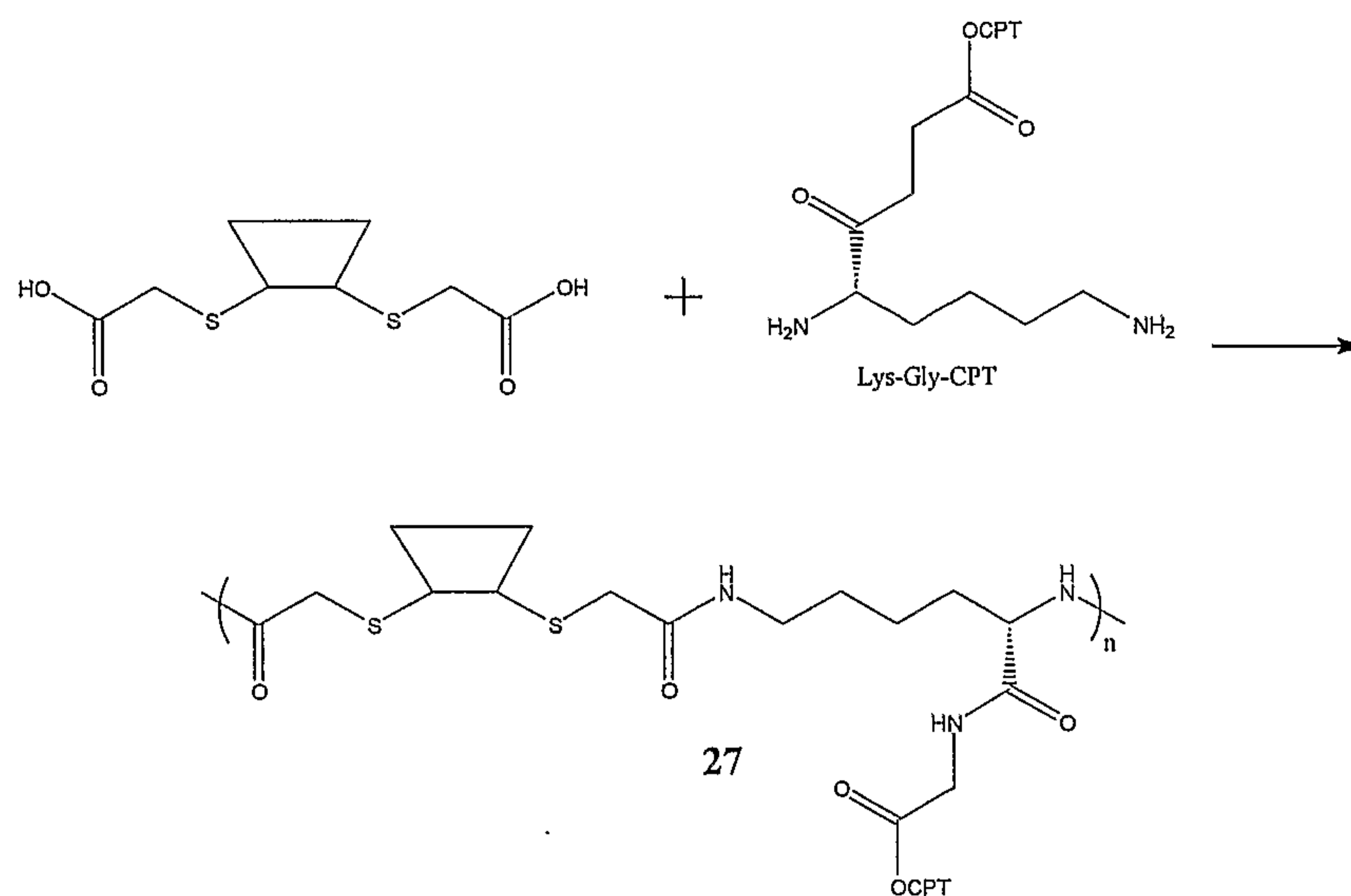

CDDM, **5**, and Lys-Gly-CPT, **14**, are dissolved in dry DMSO. EDC (3 eq) and Sulfo-NHS (2 eq) are added to the mixture. The solution was stirred under argon for 2 days at rt. The solution is then poured into ether. The precipitate **27** is dried under vacuum.

**Example 23** Synthesis of CDDC-Cys(Boc) Copolymer **28**, CDDC-CysCopolymer **29** and its CPT Conjugate **30**

10 Scheme XXXIII

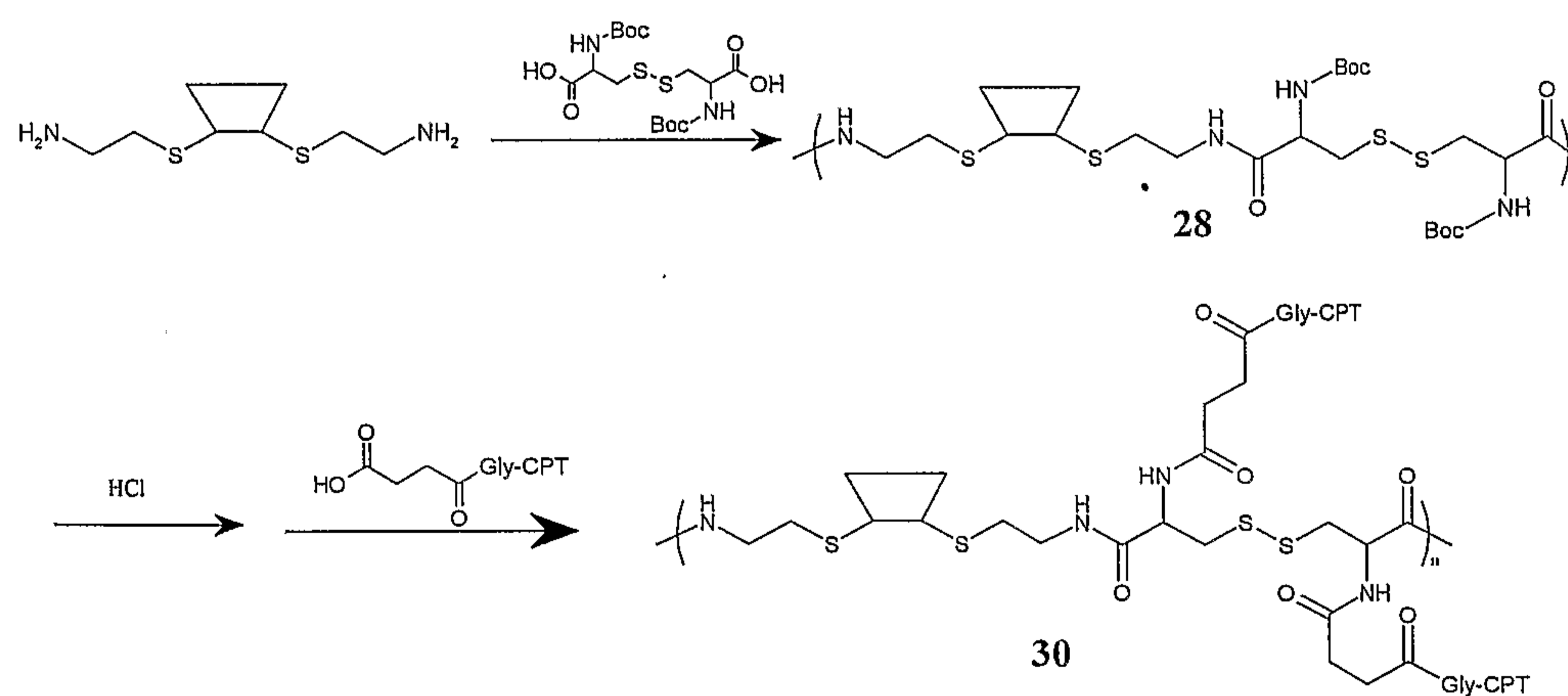

CDDC (3) and N,N-DiBoc-Cystine are dissolved in dry DMSO. EDC (3 eq) and Sulfo-NHS (2 eq) were added to the mixture. The solution was stirred under argon for 2 days at rt. The solution is then transferred to a 10,000 MWCO dialysis membrane and dialyzed for 48 hours. After lyophilization a white powder, CDDC-Cys(Boc) polymer **28**, is obtained. To the white powder **28** is added a mixture of HCl and DMSO solution. The solution is stirred at rt for 1 h and then dialyzed against water for 24 h using 10,000 MWCO membrane. **29** is obtained as a white solid.

**Suc-Gly-CPT 15** is mixed with **29** in DMSO solution. EDC (2 eq), NHS (1 eq), and DIEA (1.0 eq) are added to the solution. The solution is stirred for 16 h under argon and then precipitated with ether. The precipitate is washed with ether until no free drug is observed in the washing solution. Compound **30** is obtained after drying under high vacuum.

**Example 24** Synthesis of biodegradable CD-Polyphosphoester Polymer **31** and its CPT conjugates **32**

Scheme XXXIV

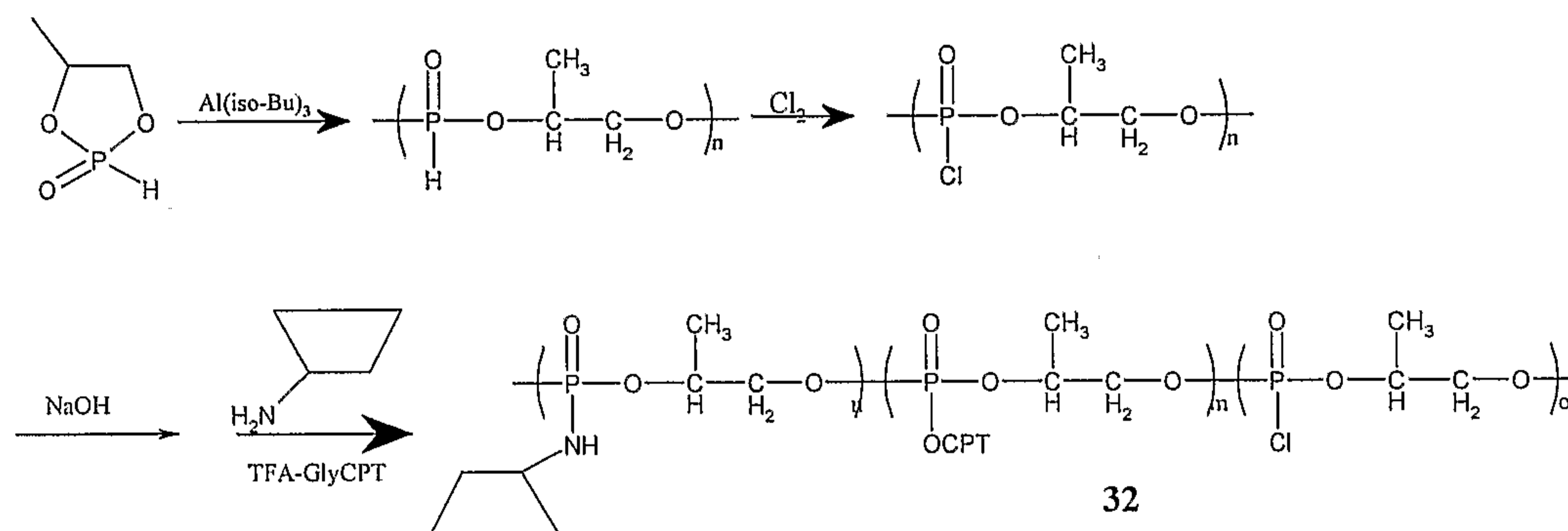

20

Synthesis of the biodegradable polyphosphoester can be found in Wang J et al, *JACS*, **2001**, *123*, 9480-9481.



Polyphosphoester is mixed with **10** (0.5 eq of repeat unit) in DMSO. EDC (2 eq), NHS (1 eq), and DIEA (1.0 eq) are added to the solution. The solution is stirred for 16 hrs and then precipitated with ether. The obtained CD-polyphosphoester **31** is dissolved in DMSO. To the solution is added **11** (0.5 eq of repeat unit), EDC (2 eq),  
 5 NHS (1 eq), and DIEA (1.0 eq). The solution is stirred for 16 h and then precipitated with ether. The precipitate is washed with ether extensively until no free drug is observed in the washing solution. Compound **32** is obtained after drying under high vacuum.

10 **Example 25** Synthesis of CD Copolymer-CPT conjugate **33** with polyethylene backbone via radical polymerization

Scheme XXXV

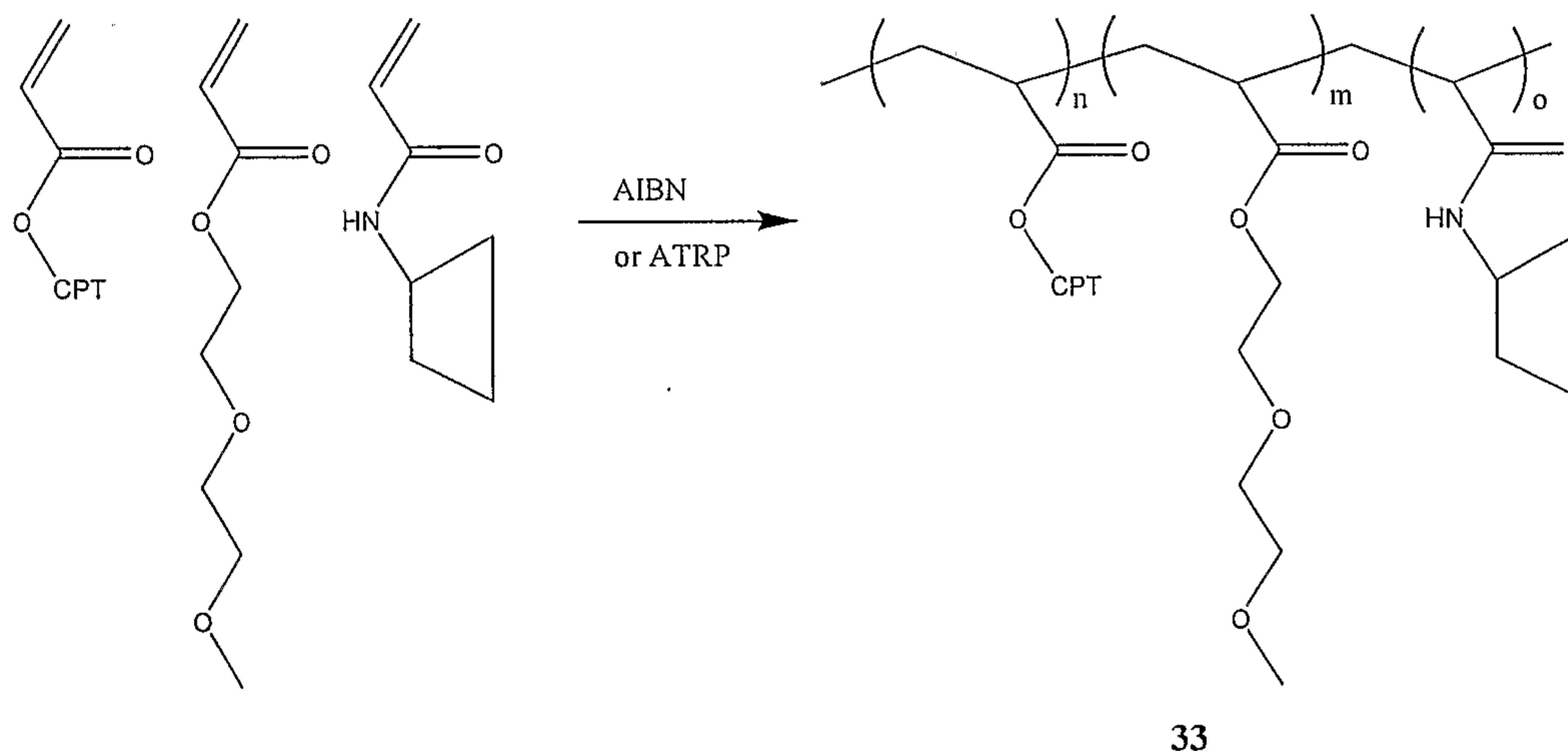

15 Acrylate monomers of CPT, triethyleneglycol monomethylether, and CD-monocystamine can be synthesized from N-Acryloxysuccinimide (Polysciences, Inc.). These monomers are mixed in 1:1:1 ratio in dry DMSO. AIBN is added to the mixture under argon. The solution is stirred at rt for 24-48 hrs until the solution becomes viscous. Polymer-CPT conjugate **33** is precipitated with ether and dried  
 20 under vacuum.

**Example 26** Synthesis of CD-graft-poly(ethylene-*alt*-maleic anhydride)-GlyGlyGlyCPT **34**

Scheme XXXVI

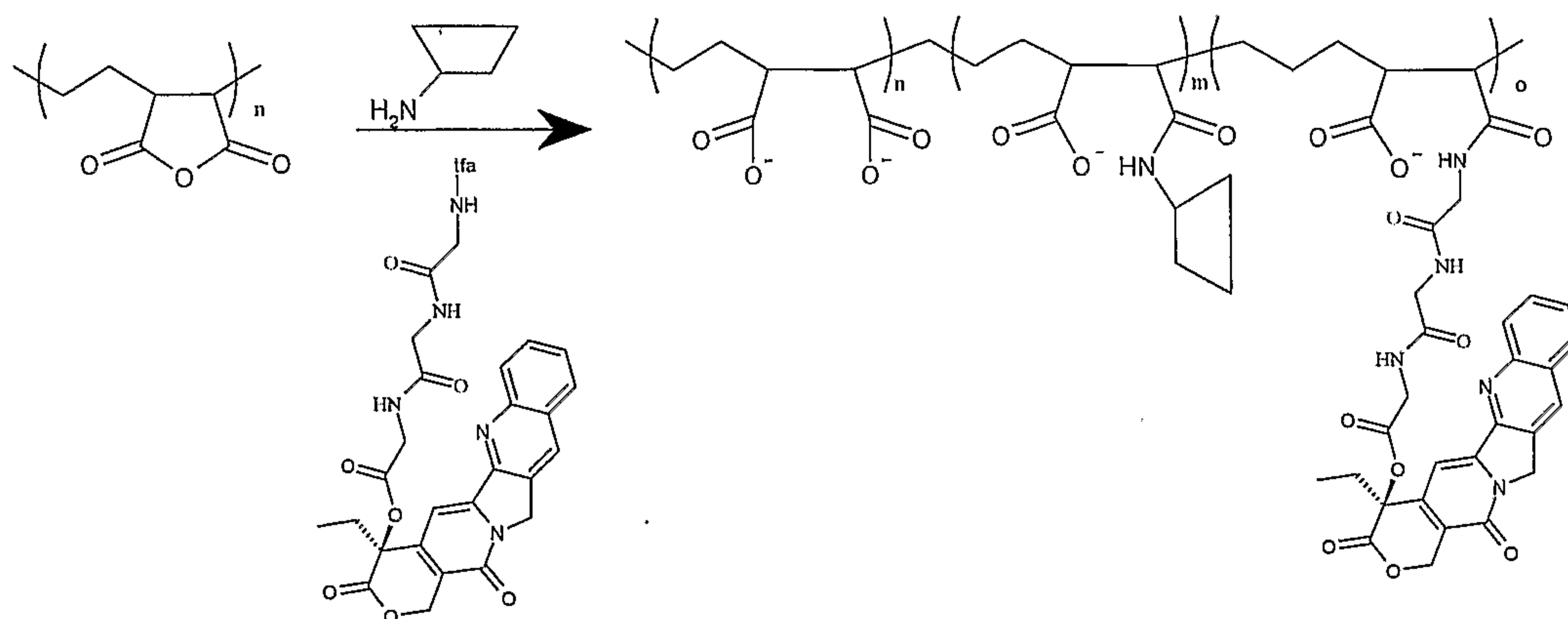

34

Poly(ethylene-*alt*-maleic anhydride) (Aldrich) is dissolved in DMSO. **10** (0.4 eq of repeat unit) and **12** (0.4 eq of repeat) are added. The solution is heated at 70 °C for 16 hrs and then precipitated with ether. The obtained CD-graft-poly(ethylene-*alt*-maleic anhydride)-GlyGlyGlyCPT **34** is dried under high vacuum.

10 **Example 27** Synthesis of Polyglutamate-CD-CPT Conjugate **35**

Scheme XXXVII

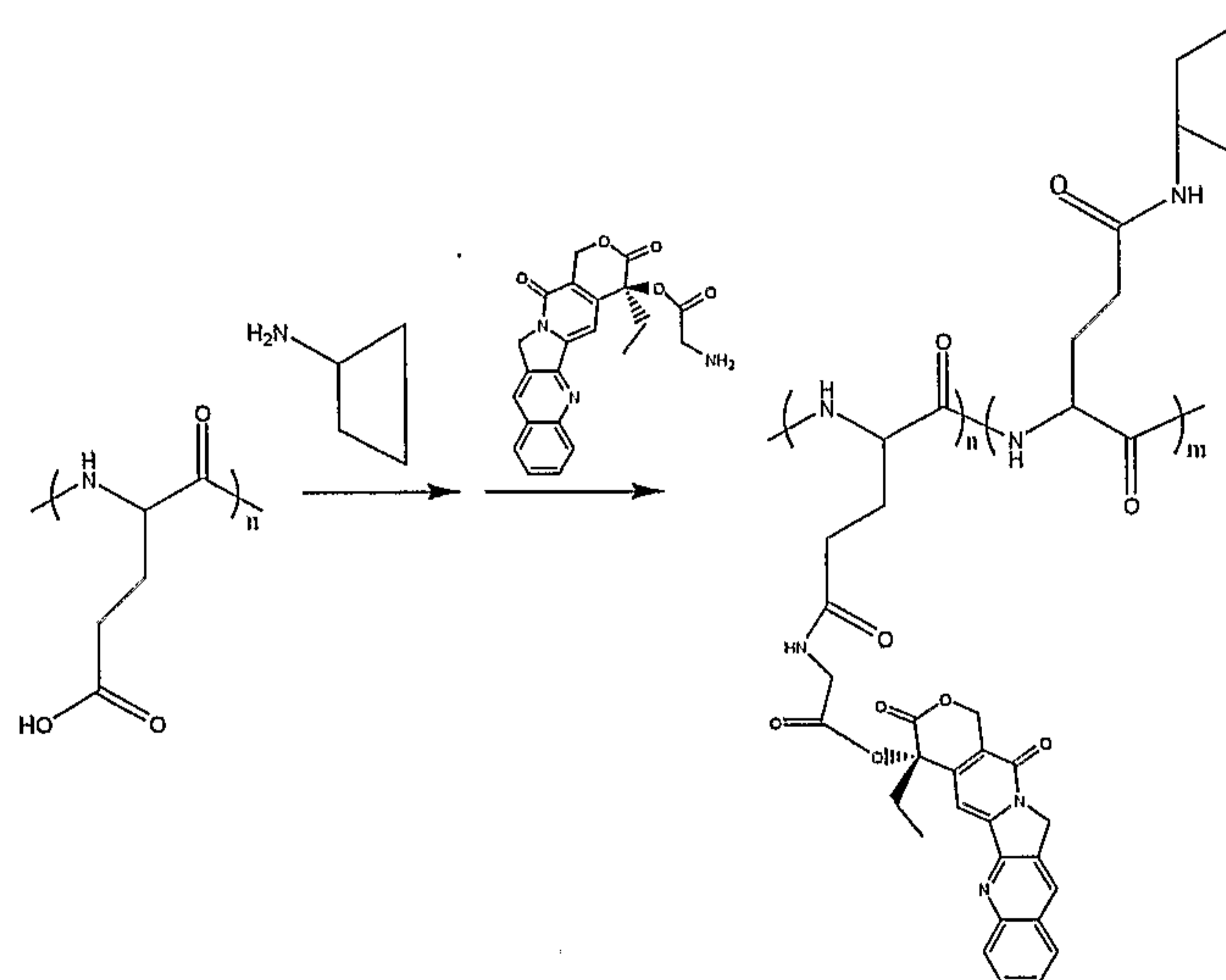

35



Polyglutamate (from Sigma-Aldrich) is mixed with **10** (0.5 eq of repeat unit) and **11** (0.5 eq of repeat unit) in DMSO. EDC (3 eq), NHS (2 eq), and DIEA (1.0 eq) are added to the solution. The solution is stirred for 16 hr and then precipitated with ether. After drying under high vacuum, polyglutamate-CD-CPT conjugate **35** is obtained.

### Example 28: Synthesis and Characterization of CD-BisCys-Peg3400 Copolymers **36** and their CPT Conjugates **37**.

#### A. Synthesis and Characterization of CD-BisCys-Peg3400 Copolymers **36**

10

Scheme XXXVIIIa

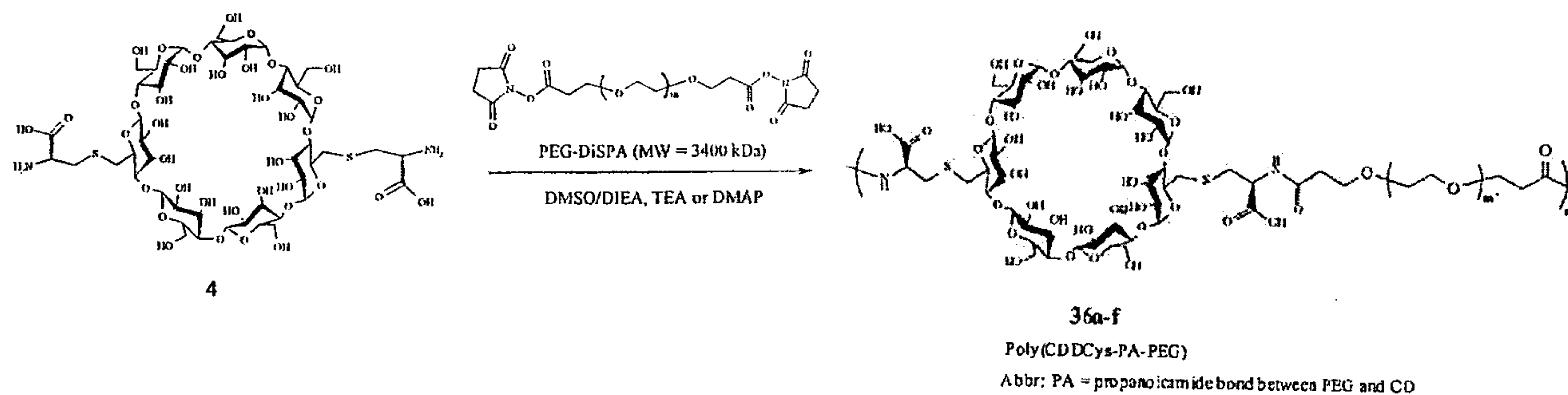

Scheme XXXVIIIb

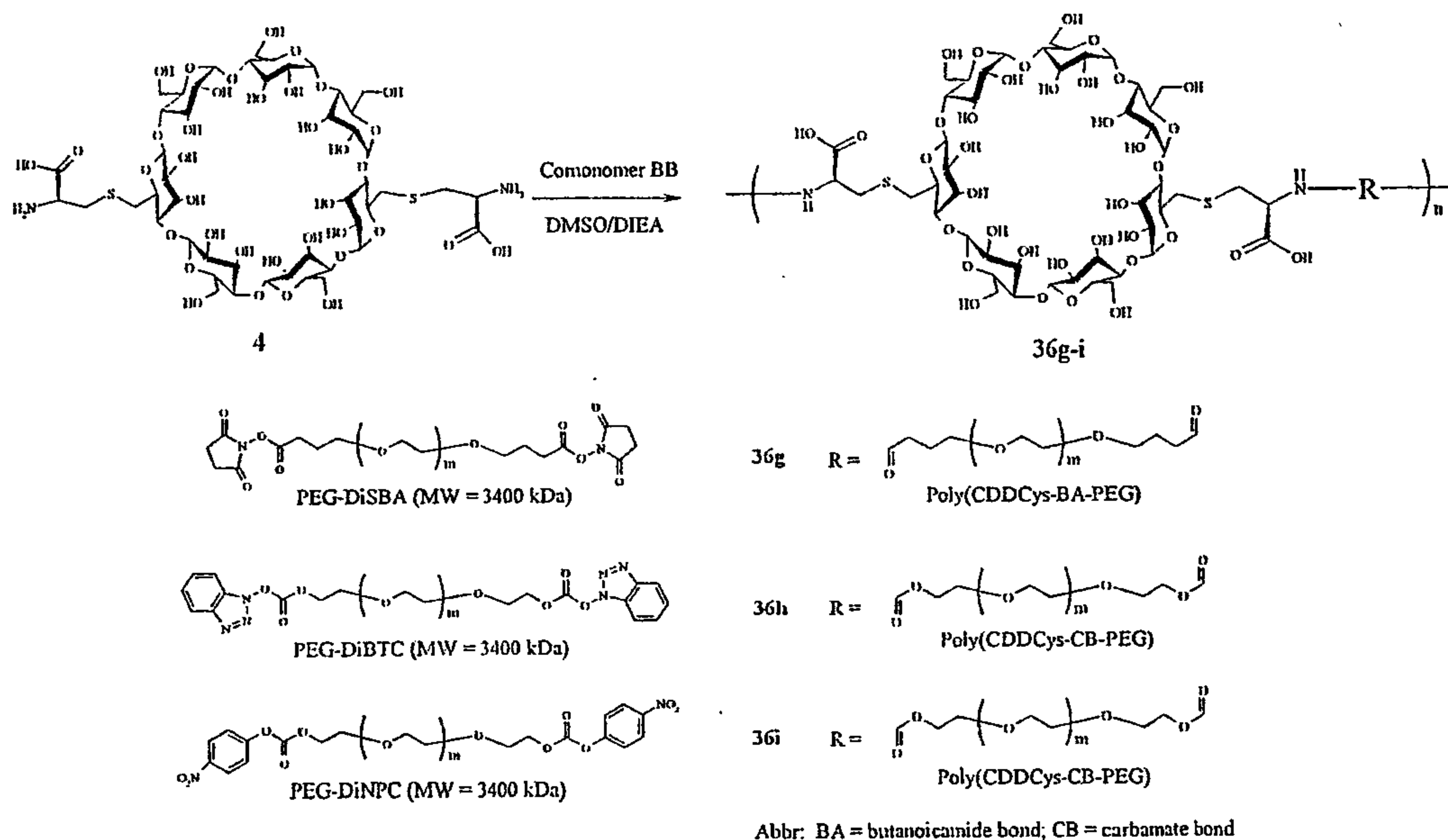

15

**Synthesis of Poly(CDDCys-PA-PEG), 36a** **4** (after precipitation with acetone, 63 mg, 0.047 mmol) and PEG-DiSPA (MW 3400, 160 mg, 0.047 mmol) were dried under vacuum for 8 hours. Anhydrous DMSO (1.26 mL) was added to the mixture under argon. After 10 minutes of stirring, anhydrous diisopropylethylamine (DIEA, 19  $\mu$ L, 2.3 eq.) was added under argon. The reaction mixture was stirred under argon for 120 h. The polymer containing solution was dialyzed using a 10,000 MWCO membrane (Spectra/Por 7) against water for 48 h and lyophilized to yield 196 mg **36a** (90%, Table 1).  $M_w = 57.4$  kDa,  $M_n = 41.7$  kDa,  $M_w/M_n = 1.38$ .  $^1\text{H NMR}$  ( $\text{D}_2\text{O}$ )  $\delta$  5.08 (m, CD-2-H), 4.27 (m, Cys-CH), 2.72-3.76 (m, CD-3,4,5,6-CH, CD-CH<sub>2</sub>, PEG-CH<sub>2</sub>), 2.44 (m, Cys-CH<sub>2</sub>).

Synthesis of other poly(CDDCys-PA-PEG) (**36b-f**), Poly(CDDCys-BA-PEG) (**36g**) Poly(CDDCys-CB-PEG) (**36h-i**) were achieved under polymerization condition similar to that of **36a**. Details for the polymerization conditions, monomer selection, polymer molecular weight, polydispersity and yields are listed in Table 1. **36g**:  $^1\text{H NMR}$  ( $\text{D}_2\text{O}$ )  $\delta$  5.10 (m, CD-2-H), 4.25-4.37 (m, Cys-CH), 2.72-3.86 (m, CD-3,4,5,6-CH, CD-CH<sub>2</sub>, PEG-CH<sub>2</sub>), 2.21 (m, Cys-CH<sub>2</sub>). **36h-i**:  $^1\text{H NMR}$  ( $\text{D}_2\text{O}$ )  $\delta$  5.05 (m, CD-2-H), 4.56 (m, Cys-CH), 2.70-3.93 (m, CD-3,4,5,6-CH, CD-CH<sub>2</sub>, PEG-CH<sub>2</sub>), 2.38 (m, -OCH<sub>2</sub>CH<sub>2</sub>CH<sub>2</sub>C(O)-NH-), 2.34 (m, Cys-CH<sub>2</sub>), 1.90 (m, -OCH<sub>2</sub>CH<sub>2</sub>CH<sub>2</sub>C(O)-NH-).

Addition of a non-nucleophilic organic base (such as DIEA) was essential for this polymerization as no viscosity changes of the polymerization solutions were observed after 48 hours if no base was added. When 2.3 eq. of DIEA were added, the viscosity of the polymerization solution increased dramatically after 4-6 hours of reaction. DIEA deprotonates the amino groups of **4** to render them more nucleophilic for coupling with PEG-DiSPA. There were essentially no differences in the polymerizations if other bases, such as TEA or DMAP, were used (**36b-c**, Table 1). Polymerization using **4** recovered by the two different precipitation methods (acetone and methanol) produced polymers with different MWs. **4** that was purified by the methanol-precipitation method (contains no free cystine) gave higher MW polymer (**36d-e**) as compared to the less pure **4** that was obtained from the acetone-



precipitation method (**36a**). Polymerization of **4** with PEG-DiSPA typically produced polymer yields greater than 90%.

**4** was polymerized with other activated monomers such as PEG-DiSBA, PEG-DiBTC, and PEG-DiNPC. Reaction of **4** with PEG-DiSBA gave polymer **36g** with similar linkages as **36a-f** (amide bond, but one more  $-\text{CH}_2$  group than **36a-f** at the linker) with  $M_w$  over 100 kDa, while reaction of **4** with PEG-DiBTC and PEG-DiNPC generated polymers **36h** and **36i**, respectively, with connecting carbamate moiety and  $M_w$ 's over 50 kDa (Table 1).

10

**Table 1.** Polymerization of **4** with difunctionalized PEG

CDP	PEG Comonomer	Base	Polymerization time (h)	$M_w$ (kDa)	$M_n$ (kDa)	$M_w/M_n$	Yield (%)
<b>36a</b> <sup>a</sup>	PEG-DiSPA	DIEA	120	57.4	41.7	1.38	90
<b>36b</b> <sup>a</sup>	PEG-DiSPA	DMAP	120	54.2	38.1	1.42	91
<b>36c</b> <sup>a</sup>	PEG-DiSPA	TEA	120	57.4	42.6	1.35	91
<b>36d</b> <sup>b</sup>	PEG-DiSPA	DIEA	120	93.6	58.0	1.48	96
<b>36e</b> <sup>b</sup>	PEG-DiSPA	DIEA	144	97.3	58.0	1.67	94
<b>36f</b> <sup>b</sup>	PEG-DiSPA	DIEA	2	35.3	25.6	1.38	95
<b>36g</b>	PEG-DiSBA	DIEA	120	114.7	77.9	1.47	96
<b>36h</b>	PEG-DiBTC	DIEA	120	67.6	39.4	1.47	95
<b>36i</b>	PEG-DiNPC	DIEA	120	86.5	57.2	1.51	96

<sup>a</sup> **4** was washed with acetone before polymerization.

15

<sup>b</sup> **4** was washed with methanol before polymerization.

Polymers **36a-i** are highly soluble in aqueous solution. They can be easily dissolved in water or phosphate buffered saline (PBS) solution at concentrations of at least 200 mg/mL. Solubility of these polymers in aqueous solution at concentrations higher than 200 mg/mL was not attempted due to the high viscosity. These polymers were also soluble in DMF, DMSO and methanol, slightly soluble in  $\text{CH}_3\text{CN}$  and  $\text{CHCl}_3$ , but insoluble in THF and ethyl ether.

20

**Molecular Weight Control of CD Polymers** 4 (after precipitation with methanol) (56.2 mg, 0.0419 mmol) and PEG-DiSPA (147 mg, 0.0419 mmol) were dried under vacuum for 4-8 hours. To the mixture was added dry DMSO (1.1 mL) under argon. After 10 minutes stirring, DIEA (16  $\mu$ L, 2.2 eq) was added under argon. A portion of polymerization solution (150  $\mu$ L) was removed and precipitated with ether at selected times (2 h, 18 h, 43 h, 70 h, 168 h and 288 h). MWs of the precipitated polymers were determined as described above.

As shown in Figures 5a and 5b, molecular weights of 36 can be controlled by adjusting polymerization time.

### B. Synthesis of Poly(CDDCys-PA-PEG)-CPTConjugates (HGGG6, LGGG10, HG6, HGGG10).

Scheme XXXIX

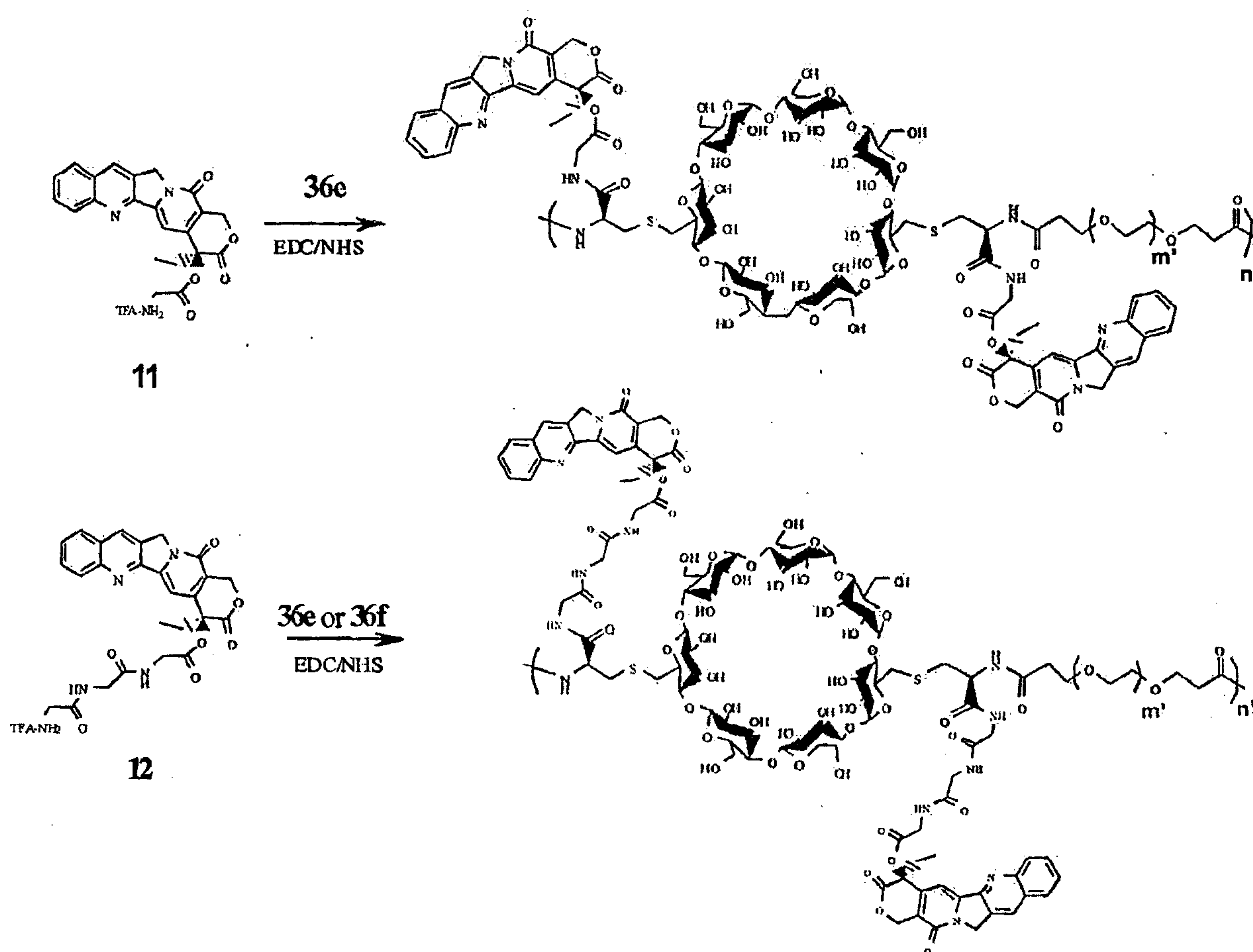



Synthesis of Poly(CDDCys-PA-PEG)-GlyGlyGly-CPT (**HGGG6**) **36e** (1.37 g, 0.30 mmol of repeat unit) was dissolved in dry DMSO (136 mL). The mixture was stirred for 10 minutes. **12** (419 mg, 0.712 mmol, 2.36 eq), DIEA (0.092 mL, 0.712 mmol, 2.36 eq), EDC (172 mg, 0.903 mmol, 3 eq), and NHS (76 mg, 0.662 mmol, 2.2 eq) were added to the polymer solution and stirred for ca. 15 hours. The polymer was precipitated with ethyl ether (1 L). The ether was poured out and the precipitate was washed with CH<sub>3</sub>CN (3 × 100 mL). The precipitate was dissolved in water 600 mL. Some insoluble solid was filtered through 0.2 μm filters. The solution was dialyzed using 25,000 MWCO membrane (Spectra/Por 7) for 10 h at 10-15 °C in DI water. Dialysis water was changed every 60 minutes. The polymer-drug conjugate solution was sterilized by passing it through 0.2 μm filters. The solution was lyophilized to yield a yellow solid **HGGG6** (1.42 g, 85% yield).

Synthesis of Poly(CDDCys-PA-PEG)-GlyGlyGly-CPT (**LGGG10**) Conjugation of **12** to **36f** was performed in a manner similar to that used to produce **HGGG6** except that this conjugate was dialyzed with 10,000 MWCO membrane (Spectra/Por 7) instead of with 25,000 MWCO membrane. The yield of **LGGG10** was 83%.

Synthesis of Poly(CDDCys-PA-PEG)-Gly-CPT (**HG6**) Conjugation of **11** to **36e** was performed in a manner similar to that used to produce **HGGG6**. The yield of **HG6** was 83%.

Synthesis of Poly(CDDCys-PA-PEG)-GlyGlyGly-CPT (**HGGG10**) **36e** (1.5 g, 0.33 mmol of repeat unit) was dissolved in dry DMSO (150 mL). The mixture was stirred for 10 minutes. **12** (941 mg, 1.49 mmol, 4.5 eq), DIEA (0.258 mL, 1.49 mmol, 4.5 eq), EDC (283 mg, 1.49 mmol, 4.5 eq), and NHS (113 mg, 0.99 mmol, 3 eq) was added to the polymer solution and stirred for ca. 24 hours. Another portion of EDC (142 mg, 0.75 mmol, 2.3 eq) and NHS (56 mg, 0.5 mmol, 1.5 eq) were added to the conjugation solution. The polymer was stirred for an additional 22 hours. The workup procedure was the same as that for the synthesis of **HGGG6**. The yield of **HGGG10** was 77%.

**Determination of wt% CPT on the Conjugates** Stock solutions of **HGGG6**, **LGGG10**, **HG6** and **HGGG10** were prepared at a concentration of 10 mg/mL in DMSO. An aliquot of corresponding stock solution was diluted to 100

$\mu\text{g/mL}$  using 1 N NaOH. CPT was completely hydrolyzed in this basic solution and transformed to its carboxylate form within 2 h at room temperature. An aliquot of this solution was diluted to 10  $\mu\text{g/mL}$  using 8.5%  $\text{H}_3\text{PO}_4$ , and the CPT carboxylate form was transformed to its lactone form. 30  $\mu\text{L}$  of this solution was injected into the HPLC. The peak area from the CPT lactone form was integrated and compared to a standard curve.

**11** and **12** were conjugated to **36e** or **36f** (Table 2) using conventional coupling methods. Due to the instability of the ester linker of **11** and **12** in aqueous solution, the conjugation was conducted in anhydrous DMSO under argon. An organic base was required to deprotonate the TFA salts of **11** and **12** to facilitate the coupling. For polymer conjugation with **12**, the weight percent (wt%) drug loading was around 6-10%. The theoretical maximum drug loading is around 13% using PEG with MW of 3400 Da; maximum values can be increased by decreasing the MW of the PEG segments. Solubilities of all conjugates in water or PBS were more than 200 mg/mL (equivalent to a 12-20 mg CPT/mL for 6-10 wt% drug loading, respectively). Details for the **HGGG6**, **LGGG10**, **HG6**, and **HGGG10** are summarized in Table 2.

Table 2. Properties of polymer-CPT conjugates.

Conjugate <sup>a</sup>	$M_w$ of parent polymer ( $\times 10^{-3}$ )	$M_w/M_n$ <sup>b</sup>	Linker	CPT (wt%)
<b>HGGG6</b>	97	1.7	triglycine	6.1
<b>LGGG10</b>	35	1.6	triglycine	10.2
<b>HG6</b>	97	1.7	glycine	6.8
<b>HGGG10</b>	97	1.7	triglycine	9.6

<sup>a</sup>Abbreviations: **H** = High  $M_w$  polymer (97 kDa), **L** = Low  $M_w$  polymer (35 kDa), **G****G****G** = triglycine linker, **G** = glycine linker, **6** = drug loading around 6 wt%, **10** = drug loading around 10 wt%.

<sup>b</sup> Polymer polydispersity as measured by light scattering techniques(26)



### C. Release of CPT from HGGG6 and HG6

*Release of CPT in PBS* **HGGG6** and **HG6** were prepared at 1 mg/mL in PBS (1×, pH 7.4). A 100  $\mu$ L aliquot of the solution was transferred to a 1.5 mL Eppendorf tube and incubated at 37 °C. The incubated samples were quenched at selected time intervals and stored at -80 °C until the analysis. Each solution was diluted with 8.5% H<sub>3</sub>PO<sub>4</sub> to a 5 mL total volume in a volumetric flask. 30  $\mu$ L of such solution was injected into the HPLC. The peak area from the CPT lactone form was integrated and compared to a standard curve.

10 Analysis for the release of CPT from **HGGG6** and **HG6** in PBS containing acetyl cholinesterase (an esterase, 100 units/mL), in KH<sub>2</sub>PO<sub>4</sub> buffer (pH 6.1, 0.1 M) and in the KH<sub>2</sub>PO<sub>4</sub> buffer (pH 6.1, 0.1 M) containing cathepsin B (a cysteine proteinase, 200  $\mu$ M, preactivated on ice for 30 minutes in this buffer containing 2 mM DTT and 1 mM EDTA) were performed in a manner similar to that described  
15 above for PBS alone.

*Release of CPT in Human Plasma* An aliquot of **HGGG6** and **HG6** stock solution were diluted to give final concentration of 0.5 mg/mL in PBS (1×, pH 7.4). This solution was added to a lyophilized powder of human plasma to reconstitute 100% human plasma by the recommended amount. The solution was divided into  
20 equal volume (250  $\mu$ L) to 1.5 mL Eppendorf tubes, incubated at 37 °C, and stopped at selected time point. Samples were stored at -80 °C until the analysis. Samples were separated from plasma by solid phase extraction columns. The solid phase extraction cartridge (Oasis HLB 1cc cartridge from Waters) was pre-conditioned with 1 mL of acetonitrile and then with 1 mL of 8.5% H<sub>3</sub>PO<sub>4</sub> before loading.  
25 Samples were acidified with equal volume of 8.5% H<sub>3</sub>PO<sub>4</sub> prior to loading. After the acidified solution was loaded on the cartridge, the bed was washed with 3  $\times$  1mL of water. Released CPT and polymer conjugate were eluted with 3  $\times$  1 mL of a solution mixture of acetonitrile and potassium phosphate buffer (pH 4.1) (60/40 v/v). The eluted solution was diluted to 5 mL total volume in a 5 mL volumetric flask.  
30  $\mu$ L of such solution was injected into the HPLC. The peak area from the CPT lactone form was integrated and compared to a standard curve.

Release of CPT from **HGGG6** and **HG6** in PBS containing 4% human plasma (PBS/reconstituted human plasma solution = 96/4 (v/v)), in mouse plasma and in reconstituted human albumin (PBS solution) were performed in a manner similar to that described above for pure human plasma.

5 In PBS (1x, pH 7.4), the half-lives ( $t_{1/2}$ ) for releasing CPT from **HG6** and **HGGG6** were 59h and 32h, respectively. The half-lives decreased to 25h and 22h, respectively, in the presence of 4% human plasma, and to 1.7h and 1.6h, respectively, in 100% human plasma ("HP") and 2.6h and 2.2h, respectively, in 100% mouse plasma ("MP"). CPT release rates for both **HG6** and **HGGG6** in the  
10 presence of albumin ("Alb") or acetyl cholinesterase ("Ac Cho") were on the same order of magnitude as in PBS. In a buffer solution at a pH lower than PBS (pH 6.1) with or without the enzyme cathepsin B (active at pH 6.1), less than 50% of total conjugated CPT was released from both **HG6** and **HGGG6** for times up to 144 h (Table 3).

15

Table 3. Half-life ( $t_{1/2}$ , in hour) of the release of CPT from **HG6** and **HGGG6**<sup>a</sup>

20

Conjugate	PBS <sup>b</sup>	4% HP <sup>c</sup>	HP <sup>d</sup>	MP <sup>e</sup>	Alb <sup>f</sup>	Ac Cho <sup>g</sup>	pH 6.1 buffer <sup>h</sup>	Cath B (pH 6.1) <sup>i</sup>
<b>HG6</b>	59	25	1.7	2.6	62	33	>144	>144
<b>HGGG6</b>	32	22	1.6	2.2	73	43	>144	>144

<sup>a</sup>  $t_{1/2}$  is defined as time (hours) for the release of half of the total conjugated CPT.

Abbreviations: HP means human plasma, MP means mouse plasma.

<sup>b</sup> pH 7.4 PBS 1x buffer.

25 <sup>c</sup> Reconstituted human plasma mixed with PBS (v/v = 4/96).

<sup>d</sup> Reconstituted human plasma

<sup>e</sup> Fresh mouse plasma



<sup>f</sup> In reconstituted human albumin PBS buffer

<sup>g</sup> In the presence of acetyl cholinesterase PBS solution (100 units/mL).

<sup>h</sup> pH 6.1 phosphate buffer (0.1M)

<sup>i</sup> pH 6.1 phosphate buffer in the presence of Cathepsin B

5 *Release of CPT in Solution at Different pH.* **HGGG6** and **HG6** were prepared at 1 mg/mL in buffer solution with pHs ranging from acidic (pH = 1.2) to basic (pH = 13.1) and incubated at 37 °C for 24h. An aliquot of each solution was diluted with 8.5% H<sub>3</sub>PO<sub>4</sub> to about 100 µg/mL. 30 µL of such solution was injected into HPLC. The peak area from the CPT lactone form was integrated and compared  
10 to a standard curve.

The pH of aqueous solution has a significant effect on the CPT release rates from both **HG6** and **HGGG6**. The amounts of CPT released from **HG6** and **HGGG6** at 37 °C after 24 h in buffer solutions with pHs ranging from 1.1 to 13.1  
15 are illustrated in Figure 6. The glyciny-CPT ester bonds of both **HG6** and **HGGG6** were very stable in acidic pH (1.1 to 6.4) as less than 7% of CPT were released in 24 h.

**IC<sub>50</sub> via MTT Assay** The human ovarian carcinoma A2780 cell line was  
20 obtained from the European Collection of Cell Cultures (Salisbury, Wiltshire, UK). The human colorectal adenocarcinoma HT29, human prostate carcinoma PC-3, and human colonic adenocarcinoma LS174T cell lines were obtained from the American Type Culture Collection (Rockville, MD). Cells were seeded in 96-well plates at 5000 cells/well and grown in medium containing 10% fetal bovine serum at 37 °C  
25 for 24 h in a humidified 5% CO<sub>2</sub> atmosphere. The medium was replaced with fresh medium containing CPT, **36e**, **HGGG6** or **HG6** in concentrations ranging from 1 nM to 10 µM of CPT and **36e** (CPT equivalent for **HGGG6** and **HG6**). At each concentration three wells per plate were treated. The effect of the compounds on cell growth was measured by the MTT assay after 72 h. The medium was removed,  
30 the cells were rinsed with PBS, MTT solution was added at a concentration of 0.5 mg/mL, and the plates were incubated for 4 h at 37 °C. The medium was removed and the formazan crystals were solubilized in DMSO. Absorbance was measured at

560 nm using a SPECTRAFluor Plus plate reader (Tecan, Durham, NC). The percentage of cell survival was calculated relative to untreated cells, and  $IC_{50}$ 's were determined from plots of dose versus cell survival.  $IC_{50}$  data of CPT, **36e**, **HGGG6** or **HG6** are listed in Table 4.

5

Table 4.  $IC_{50}$  of CPT, unconjugated polymer **36e** and CPT conjugates **HG6** and **HGGG6** in various cell lines

Cell Line	<b>36e</b> ( $\mu$ M)	CPT ( $\mu$ M)	<b>HG6</b> ( $\mu$ M)	<b>HGGG6</b> ( $\mu$ M)
LS174T	>300	0.005	0.050	0.010
HT29	300	0.020	0.050	0.030
A2780	100	0.007	0.025	0.020
PC3	>300	0.075	0.25	0.15

10

**Example 29: Poly-CD-BisCys-Peg3400-Ala-CPT 37**

**36e** (54 mg, 0.012 mmol of repeat unit) was dissolved in dry DMSO (226 mL) and stirred for 10 minutes. TFA-Ala-CPT which is prepared similar to **11** (15 mg, 0.028 mmol, 2.36 eq), DIEA (4.88 mL, 0.028 mmol, 2.36 eq), DCC (24.52 mg, 0.12 mmol, 10 eq), and NHS (13.6 mg, 0.12 mmol, 10 eq) were added to the polymer solution. The mixture was stirred for about 16 hours. The polymer was precipitated with ether (40 mL) and washed with ether (2 x 30 mL) and with  $CH_3CN$  (2 x 10 mL). It was then redissolved in pH 4 aqueous solution (10 mL) and dialyzed at room temperature for 48h using 25,000 MWCO membrane. The solution was then passed through a sterilized 0.2  $\mu$ m filter and then lyophilized to yield **37**(46 mg, 85%). Weight percent of drug loading was calculated to be 5.5% using HPLC equipped with a fluorescence detector after releasing CPT from **37** using base. Free CPT in **37** is <1%.

25

**Example 30: Poly-CD-BisCys-Peg3400-Leu-CPT 38**



**36e** (54 mg, 0.012 mmol of repeat unit) was dissolved in dry DMSO (226 mL) and stirred for 10 minutes. TFA-Leu-CPT which is prepared similar to **11** (16 mg, 0.028 mmol, 2.36 eq), DIEA (4.88 mL, 0.028 mmol, 2.36 eq), DCC (24.52 mg, 0.12 mmol, 10 eq), and NHS (13.6 mg, 0.12 mmol, 10 eq) were added to the polymer solution. The mixture was stirred for about 16 hours. The polymer was precipitated with ether (40 mL) and washed with ether (2 x 30 mL) and with CH<sub>3</sub>CN (2 x 10 mL). It was then redissolved in pH 4 aqueous solution (10 mL) and dialyzed at room temperature for 48 h using 25,000 MWCO membrane. The solution was then passed through a sterilized 0.2 μm filter and then lyophilized to yield **38** (42 mg, 78%).

Weight percent of drug loading was calculated to be 5.0% using HPLC equipped with a fluorescence detector after releasing CPT from **38** using base. Free CPT in **38** is < 1%.

#### Example 31: Synthesis of CD-BisCys-BisPeg-FITC **39**

Scheme XXXX

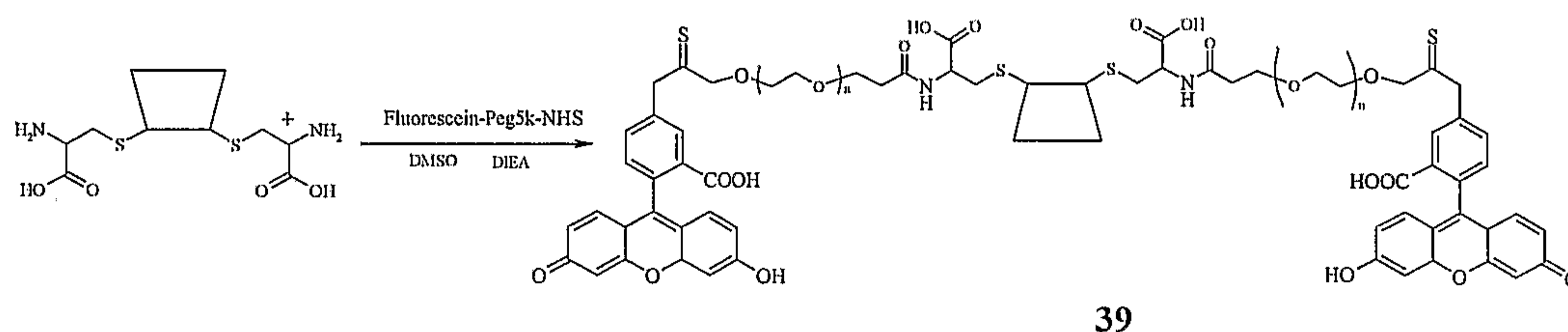

**4** (25 mg, 0.0186 mmol) and FITC-Peg5000-NHS (Shearwater, 186 mg, 0.0373 mmol) were dissolved in dry DMSO (2 mL). DIEA (0.0094 mL, 0.056 mmol, 3 eq) was added to the mixture. The mixture was kept in dark and stirred for 24 hours. Water (10 mL) was then added and the solution was dialyzed in dark using 10,000 MWCO for about 48 hours. After lyophilization a yellow polymer **39** was obtained. Polymer was characterized by MS and <sup>1</sup>H NMR.

25

**Example 32:** Synthesis of Bis-succinimidyl succinatePeg3400 (Bis-SS-PEG) (**40a**) and biodegradable CD-BisCys-SS-Peg3400 (**40b**) and its CPT conjugate **41**

Scheme XXXXI

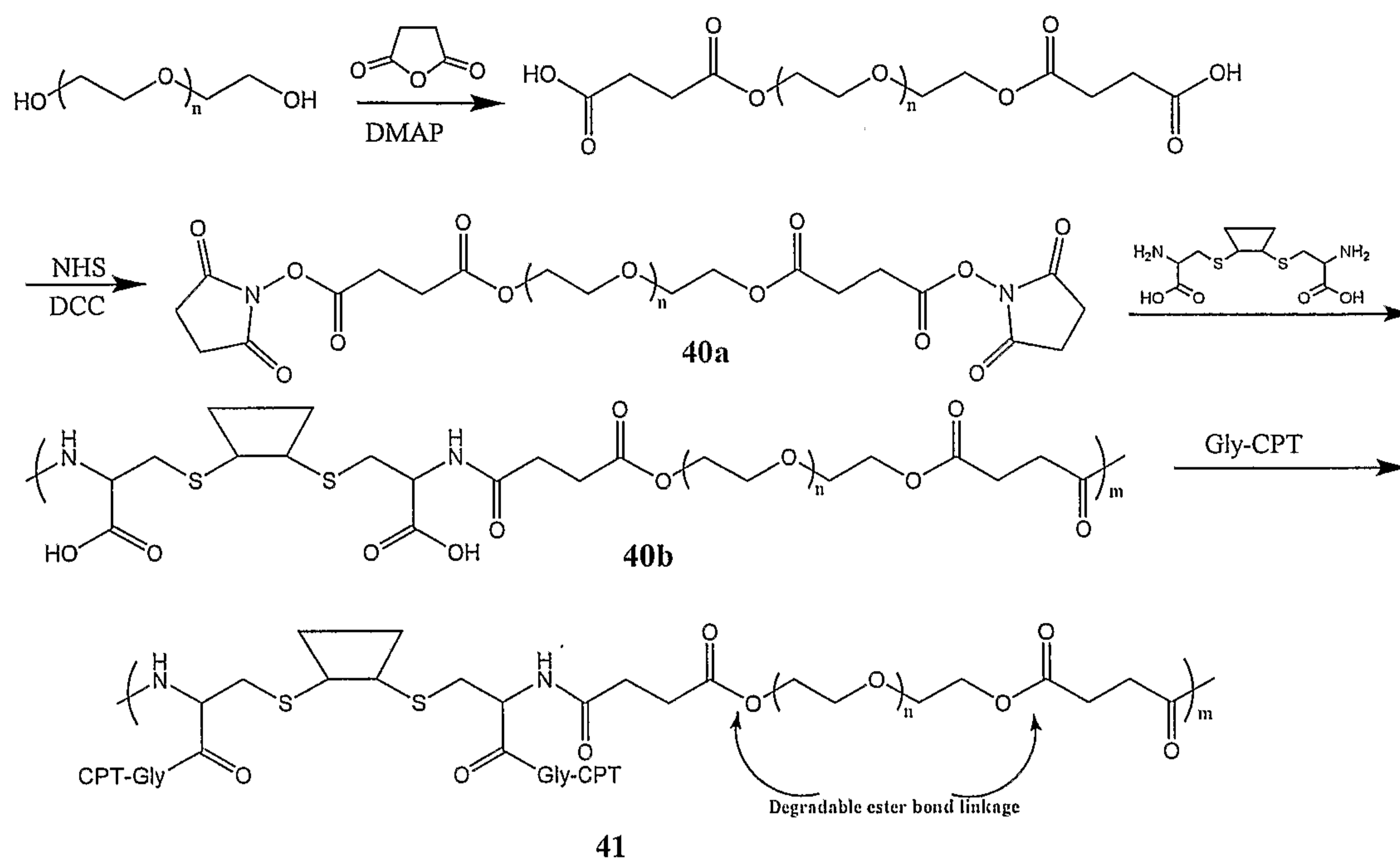

A 100 mL round bottom flask equipped with a magnetic stirbar and a septum  
 5 was charged with 10 g (2.99 mmol) of polyethylene glycol Mw 3350, 2.0 g (20  
 mmol) of succinic anhydride and 50 mL of anhydrous pyridine. After stirring the  
 solution at 50 °C for 16 h, the solvent was removed by rotary evaporator. The  
 residue was redissolved in 30 mL of water and extracted with 10 mL of chloroform  
 three times. The organic layer was dried over MgSO<sub>4</sub> and filtered. The solvent was  
 10 then concentrated and precipitated out in diethyl ether. This resulted in 9.6 g of bis-  
 succinimidyl Peg3400 at a yield of 90.6%. The product was analyzed by reverse-  
 phase columned High Performance Liquid Chromatography.

A 100 mL round bottom flask equipped with a magnetic stirbar and a septum  
 was charged with 2 g (0.56 mmol) of bis-succinimidyl Peg3400 and 10 mL of  
 15 anhydrous dichloromethane. To this solution was added 0.324 g (2.82 mmol) of N-  
 hydroxyl succinimide. The solution mixture was then cooled in an ice bath and  
 added 0.58 g (2.82 mmol) of 1,3-dicyclohexylcarbodiimide. After leaving at room  
 temperature for 24 h, the solution was filtered and precipitated out in 150 mL of  
 diethyl ether. Dissolution in 10 mL dichloromethane and precipitation in diethyl  
 20 ether was repeated two times. This afforded 1.74 g (82.9 %) of Bis-SS-PEG 40a. It



was analyzed by reverse-phase columned High Performance Liquid Chromatography.

#### CD-BisCys-SS-Peg3400 Polymer 40b

5 A 50-mL pearl shaped flask was charged with 100 mg (0.0746 mmol) of **4** and 254 mg (0.0746 mmol) of **40a**. The combined solids were dried under vacuum for 24 hours before the addition of 1mL of anhydrous DMSO and 2.2 equivalents (0.164 mmol) of DIEA. The solution mixture was stirred at room temperature for 3 days and then precipitated out in diethyl ether. This yielded 100% of **40b**. Molecular  
10 weight was analyzed on a Hitachi HPLC system equipped with an Anspec RI detector, a Precision Detectors DLS detector, and a Progel-TSK G3000<sub>PWXL</sub> column using 0.1 M PBS as eluant at a 0.7 mL·min<sup>-1</sup> flow rate.  $M_w = 93,000$ ,  $M_n = 61,000$  and  $M_w/M_n = 1.5$ .

#### 15 CD-BisCys-SS-Peg3400-GlyGlyGly-CPT conjugate 41

**40b** (201.8 mg, 0.044 mmol of repeat unit), TFA-GlyGlyGly-CPT **12** (66 mg, 0.105 mmol, 2.36 eq), EDC (25.5 mg, 0.133 mmol, 3 eq), and NHS (11 mg, 0.0977 mmol, 2.2 eq) were dissolved in dry DMSO (6 mL) and stirred for 30 minutes.  
20 DIEA (19  $\mu$ L, 0.105 mmol, 2.36 eq), added to the polymer solution. The mixture was stirred for about 41 hours. The polymer was crashed out with diethyl ether (250 mL) and washed with acetonitrile (3x 25 mL). It was then re-dissolved in pH 4 water (10mg/mL) and dialyzed at room temperature for 24 hours using 10,000 MWCO membrane. The solution was then passed through a sterilized 0.2  $\mu$ m filter  
25 and then lyophilized to yield **41** (128 mg, 52%). Weight percent of drug loading was calculated to be 6.95% using HPLC equipped with a fluorescence detector after releasing CPT from **41** using base.

Hydrolysis of **41** was set up in human plasma (100% solution) at 1mg/mL. Aliquot solutions (100  $\mu$ L) were placed in 1.5mL eppendorf tubes and incubated in  
30 37 °C water bath. Then, the samples were acidified with 100  $\mu$ L of 8.5% H<sub>3</sub>PO<sub>4</sub> and loaded on pre-conditioned solid phase extraction cartridge. It was eluted with 60:40

(v/v) acetonitrile:  $\text{KH}_2\text{PO}_4$  buffer. Free CPT (lactone form) was analyzed on HPLC/Fluorescence detector using acetonitrile/  $\text{KH}_2\text{PO}_4$  buffer. Half-life was determined to be 3 h.

#### Degradation of CD-BisCys-SS-Peg3400 Polymer 40b

5            50mg/mL of 40b solution was prepared in human plasma reconstituted in PBS (pH 7.4) solution. 100  $\mu\text{L}$  aliquots were incubated at 37 °C. Each sample tube was taken out at a specific time point and crashed out in 900 $\mu\text{L}$  cold methanol. The solution was centrifuged and the supernatant was analyzed on a HPLC/ELS detector. The resulting spectrum is shown in Figure 7.

10

#### Methods for increasing drug weight percent loading

##### *Method I. Synthesis of CD-BisCys-Peg Copolymer with a short Peg linkage and its GlyCPT conjugate*

15

**Example 33: Synthesis of CD-BisCys-Peg (short PEG, e.g., Peg200-Peg2000) and its CPT Conjugate 42**

Scheme XXXXII

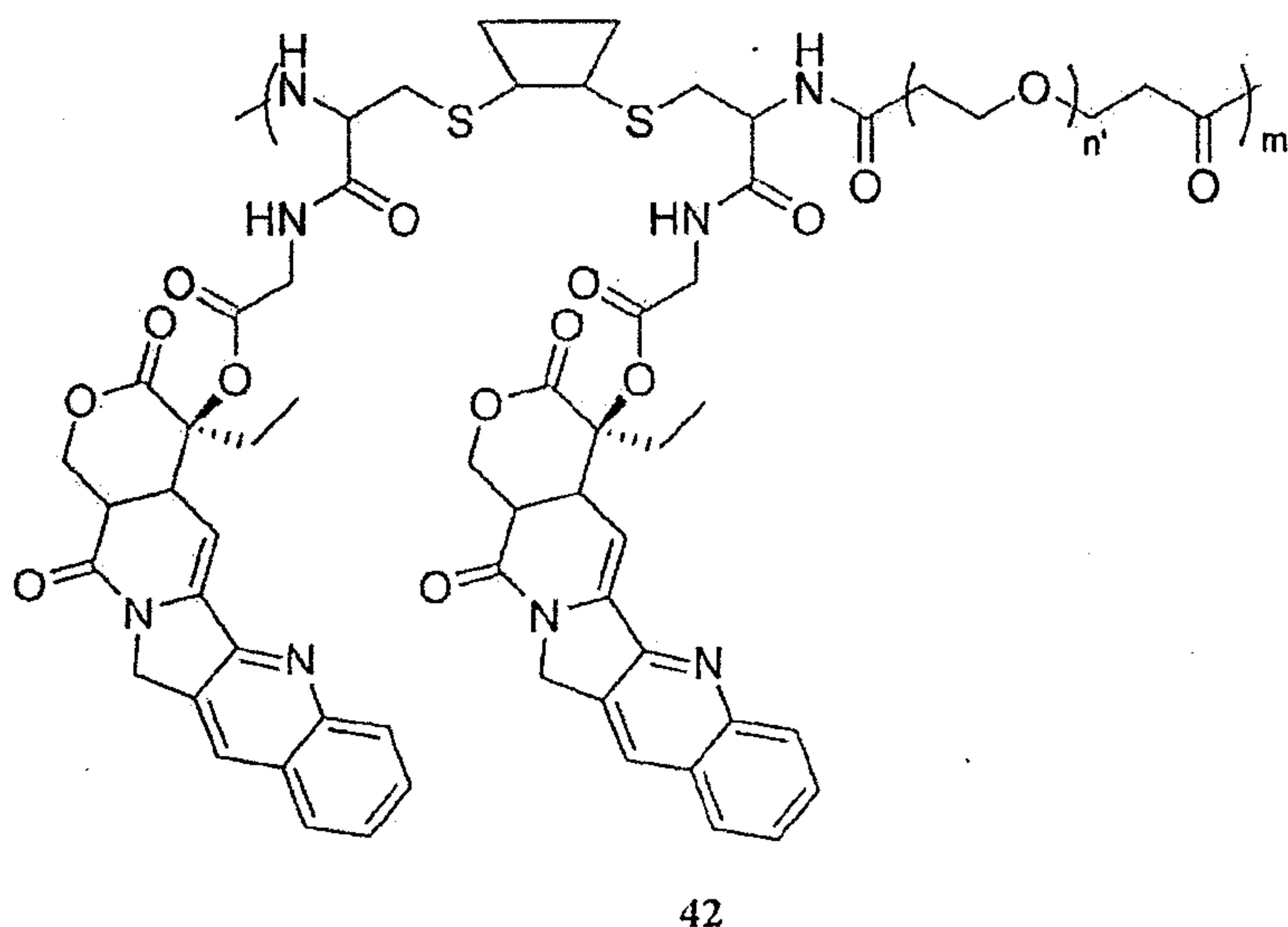

Synthesis of polymer and drug conjugate 42 are same as 36, 37, and 38 in Example 28.



**Method II. Synthesis of CD-BisCys-Peg Copolymer with multiple drug molecules on each loading site.**

**Example 34: Synthesis of CD-BisCys-Peg and its GluBis(GlyCPT) Conjugate 43.**

5 Scheme XXXXIII

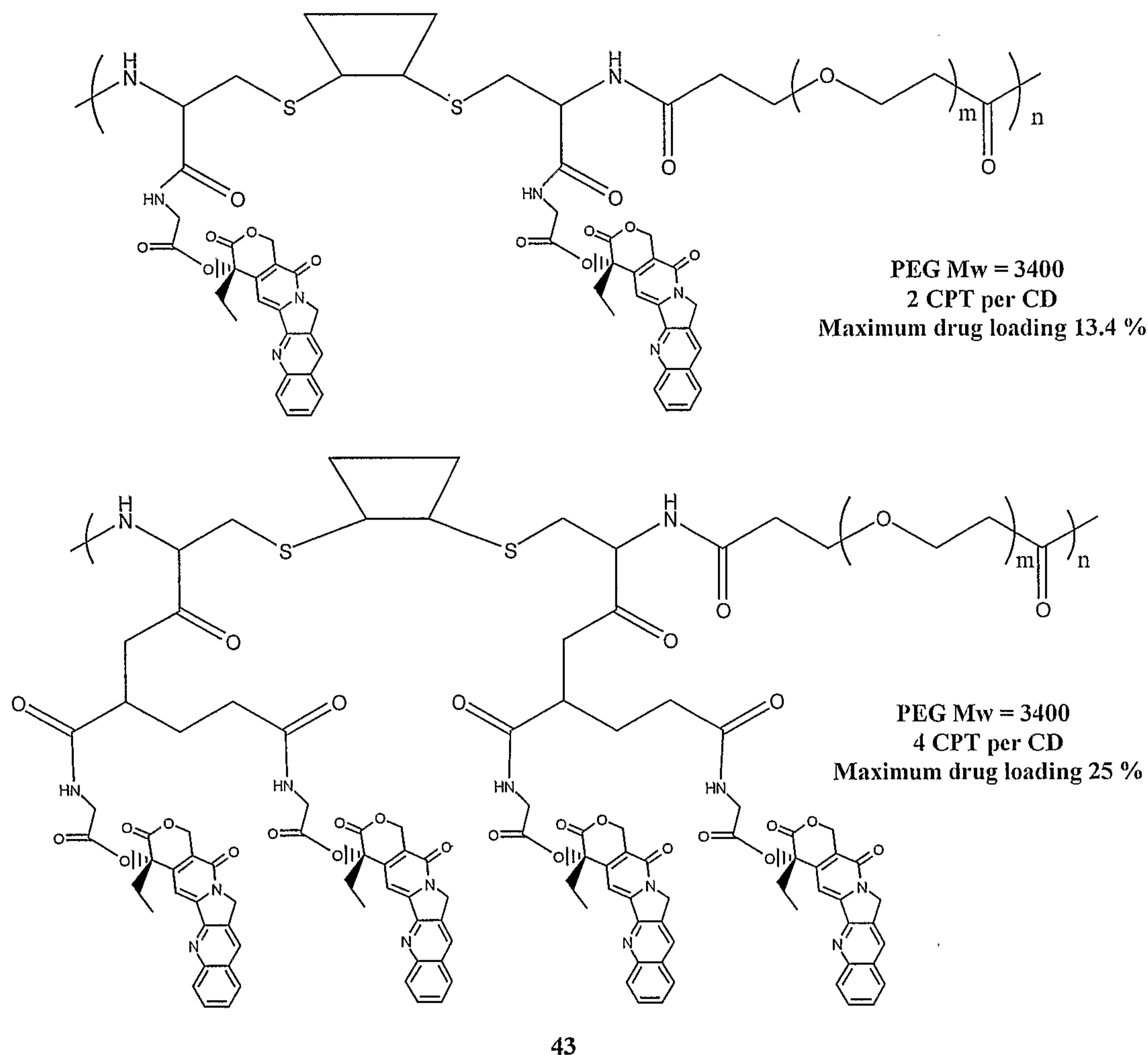

36 and Glu-Bis(Gly-CPT) 17 are dissolved in DMSO. EDC (3 eq), NHS (2.2  
10 eq), and DIEA (2.2 eq) are added to the solution. CD-BisCys-Peg-GluBis(GlyCPT)  
43 is precipitated with CH<sub>3</sub>CN and washed with the same solvent until no free drug  
is detected using UV or TLC. 43 is dried under high vacuum.

15 **Example 35: Synthesis of PEI-CD-CPT conjugate 44 (Branched CD-Polymer with  
CPT conjugates)**

**A: Synthesis of branched PEI-cyclodextrin polymer**

Scheme XXXXIV

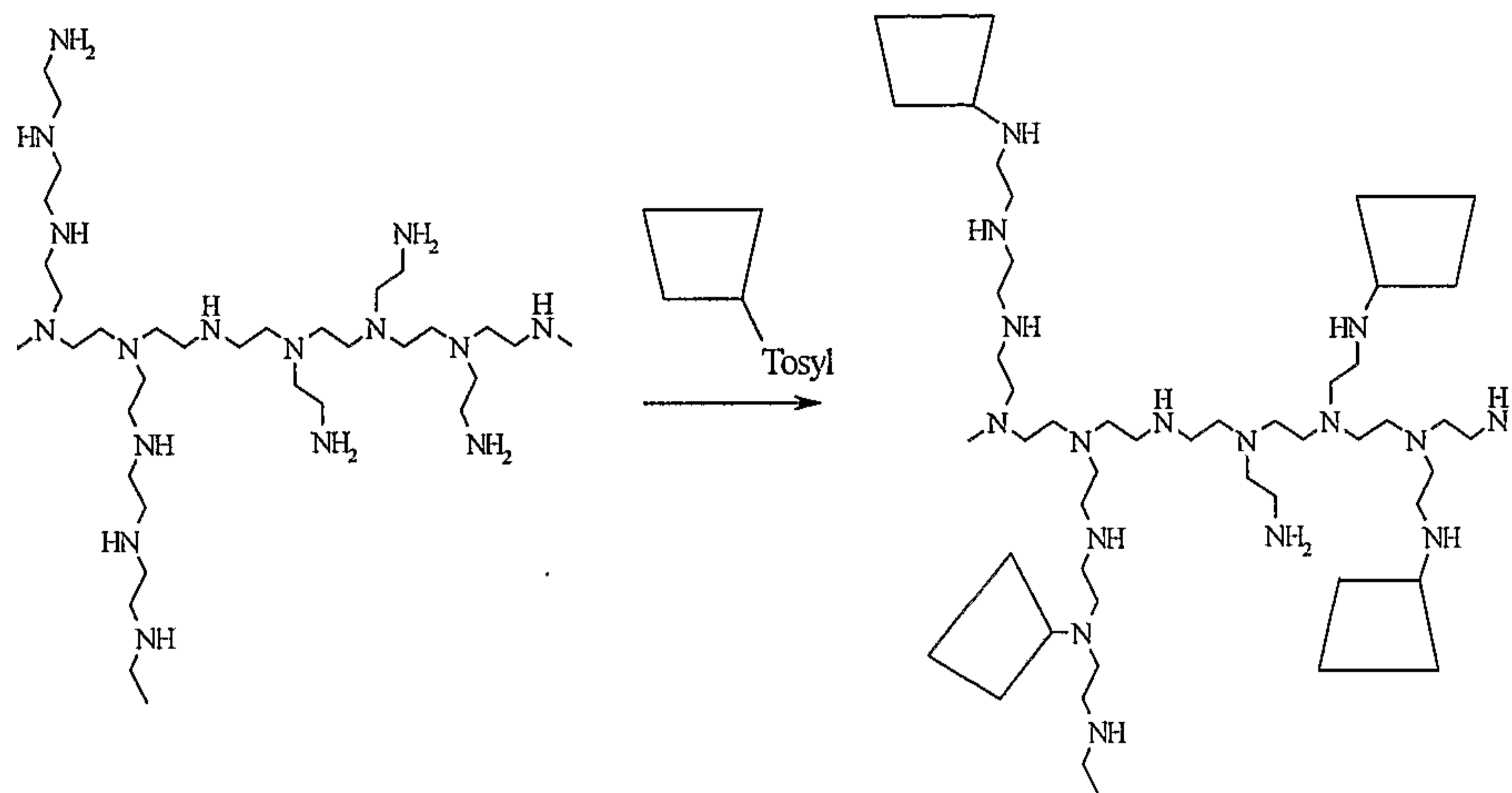

5

PEI (29 mg, Aldrich Mw 25,000) was dissolved in dry DMSO (2 mL). Cyclodextrin monotosylate (448 mg, Cyclodextrin Technologies Development, Inc.) was added to the solution under  $N_2$ . The cloudy solution turned clear after the mixture was stirred at 70 °C for about 1 hour. The solution turned slightly yellow after 48 hours at such temperature under  $N_2$ .

10

The solution was transferred to a Spectra/Por MWCO 10,000 membrane and dialyzed against water for 4 days. Water was then removed by lyophilization. A white powder was obtained (120-140 mg) after the solution was lyophilized. Cyclodextrin/PEI ratio was calculated based on the proton integration of  $^1H$  NMR.

15

**B: Synthesis of branched PEI-CD-CPT conjugate**

Scheme XXXXV



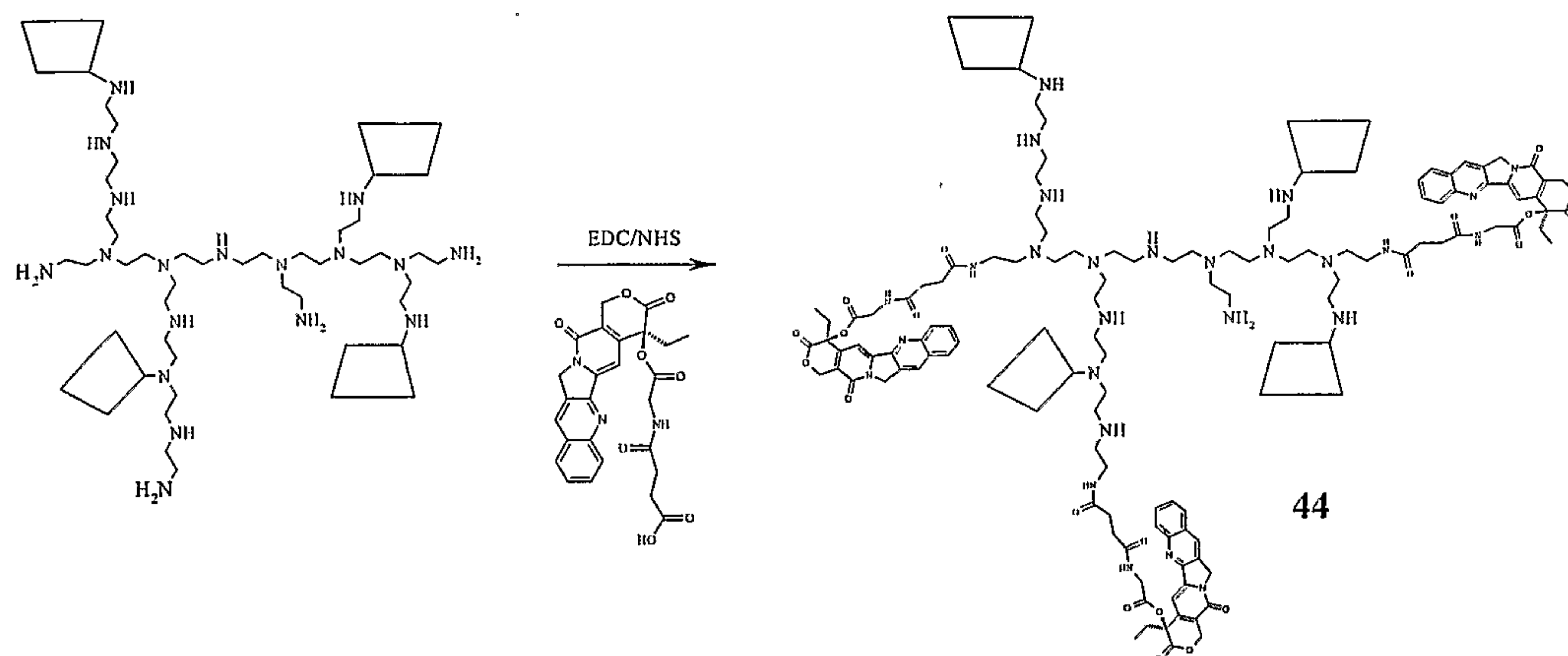

PEI-CD and Suc-Gly-CPT **15** (1.0 eq) are dissolved in DMSO. EDC (3 eq), NHS (2.2 eq), and DIEA (1 eq) are added to the solution. PEI-CD-Gly-CPT **44** is precipitated with ether, washed extensively with this solvent, and dried under high vacuum.

### Example 36: Synthesis of Ad-PEG<sub>3400</sub>-Ad **45**

Scheme XXXXVI

10

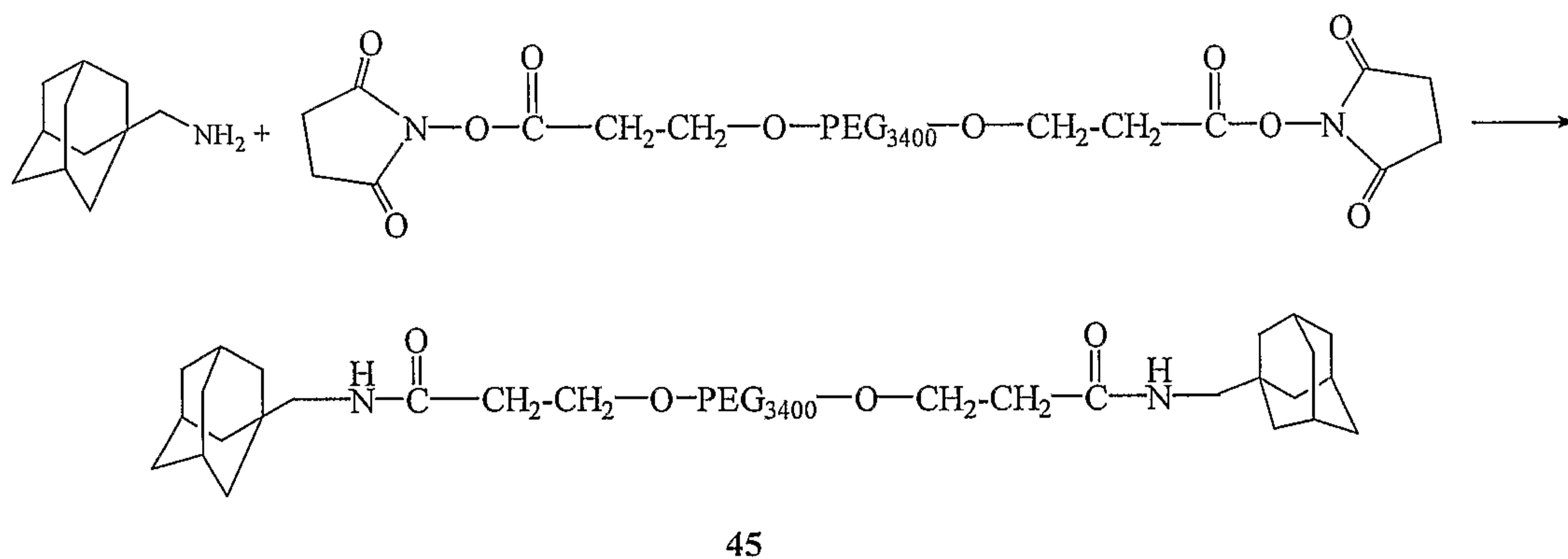

15

240 mg of 1-aminoadamantane (1.60 mmol, Aldrich) and 272 mg of PEG<sub>3400</sub>(SPA)<sub>2</sub> (0.080 mmol, Shearwater Polymers) was added to a glass vial equipped with a stirbar. To this was added 5 mL of dichloromethane, and the solution was stirred overnight. The next day, the solution was filtered to remove the *n*-hydroxysuccinimide byproduct and the dichloromethane was removed *in vacuo*. The residue was dissolved in water and centrifuged to remove excess 1-

aminoadamantane. The supernatant was then dialyzed overnight in Pierce's Slide-A-Lyzer with MWCO=3500. The solution was then lyophilized to afford 248 mg of a white fluffy solid of Ad-PEG<sub>3400</sub>-Ad **45**.

**5 Example 37: Synthesis of DiCyclodextrin PEG 46**

362 mg of CD-NH<sub>2</sub> (0.32 mmol, Cyclodextrin Technology, Inc.) and 436 mg of PEG<sub>3400</sub>(SPA)<sub>2</sub> (0.128 mmol, Shearwater Polymers) were added to a glass vial equipped with a stirbar. To this vial was added 4.36 mL of DMSO, and the solution was stirred for 72 hrs. The solution was dialyzed using 2000 MWCO membrane for  
 10 4 days in water. **46** (603 mg, 86%) was obtained as a white powder after lyophilization.

**Example 38: Synthesis of Inclusion polymer 47 using DiAD-Peg 45 and DiCD-PEG 46**

**15 46** (54.6 mg, 0.01 mmol) and **45** (34 mg, 0.01 mmol) were mixed in water (0.27 mL) and stirred for overnight. The solution is very viscous. Polymer **47** was crashed out with ether and dried under vacuum

**Example 39: Synthesis of Inclusion Polymer CPT-Conjugate 48 between DiCD-PEG 46 and a CPT-Di-AD compound**

**Synthesis of diadamantane crosslinker: Bis-(2(1-adamantyl)ethyl)phosphate**

(Zhang et al., *J. Am. Chem. Soc.*, **1997**, *119*, 1676-1681)

Scheme XXXXVII

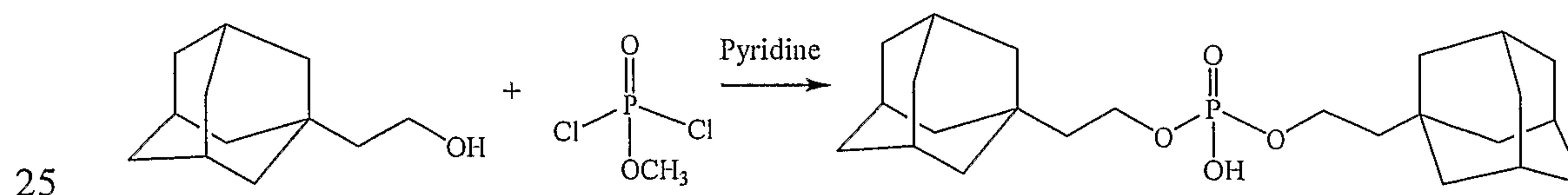

Anhydrous pyridine (10 mL, Aldrich, Milwaukee, WI) was cooled in an ice bath and methyl dichlorophosphate (1.488 g, 10 mmol, Aldrich, Milwaukee, WI)  
 30 was added dropwise. The mixture was kept cold for a further 15 min. During this



period a precipitate of N-methylpyridinium dichlorophosphate formed. 1-Adamantane ethanol (4.758 g, 26.4 mmol, Aldrich, Milwaukee, WI) was added, and the sealed mixture was stirred overnight at room temperature. It was then poured into 10% NaHCO<sub>3</sub> solution (50 mL) and the pyridine was evaporated under vacuum. 5 The slightly yellow solid was dissolved in 1 L of water and extracted with ether (three 150 mL portions). The aqueous phase was acidified with 2 N HCl to pH 1, and then extracted with three 150 mL portions of CHCl<sub>3</sub>:*n*-BuOH (7:3). The combined organic layer (ether and CHCl<sub>3</sub>:*n*-BuOH) was washed with water and a slightly yellow precipitate was formed in the mixed solvents, at which point the 10 solvents were evaporated under vacuum. A slightly yellow solid was formed and was recrystallized from acetone/hexane. The solid was dried under vacuum, yield 60 %.

## Scheme XXXXVIII

15

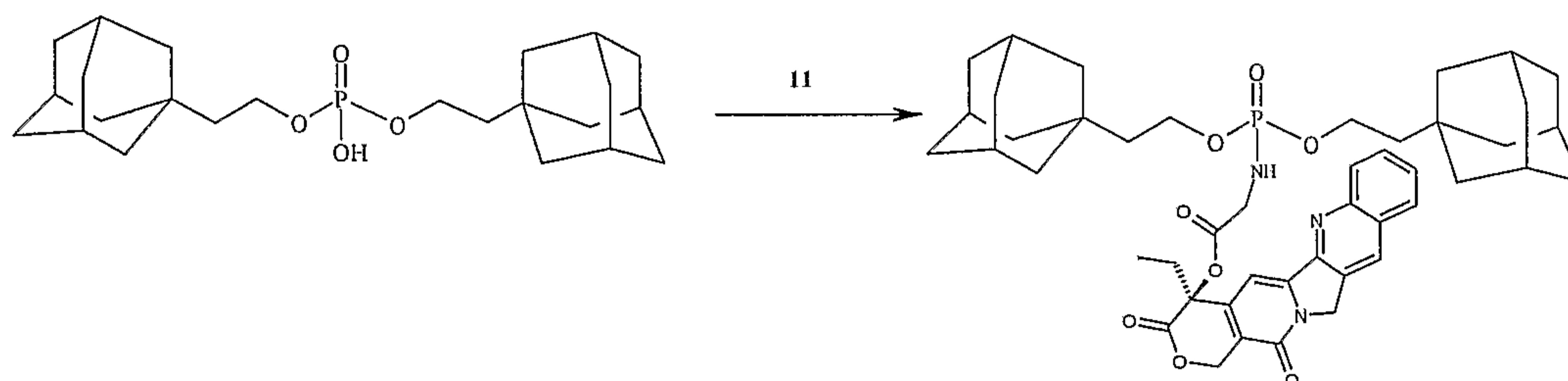

Bis-(2(1-adamantyl)ethyl)phosphate and 11 are mixed in DMSO. EDC (3 eq), NHS (2.2 eq), and DIEA (1 eq) are added to the solution. Solution is stirred 20 under argon for 16 hours. Bis-(2(1-adamantyl)ethyl)phosphate-Gly-CPT is precipitated with ether, washed extensively with this solvent, and dried under high vacuum. This compound and Di-CD-PEG 46 are mixed in DMSO to form inclusion polymer-CPT conjugate 48.

25 **Example 40: Synthesis of AD-Peg-Folate 49**

The following procedure is the synthesis of AD-Peg<sub>5000</sub>-Folate. This method can be adapted for the synthesis of any Guest molecule-Linker-Ligand tri-component molecules.

5 *1. Synthesis of AD-Peg-NH<sub>2</sub>*

266 mg of Fmoc-PEG<sub>5000</sub>-NHS (78.2  $\mu$ mol, Shearwater Polymers, Huntsville AL) were added to a glass vial equipped with a magnetic stirbar. 10 eq. of 1-adamantane-methylamine (1.5 mmol, Aldrich) dissolved in 3 mL of dichloromethane were then added and the solution stirred overnight at room  
10 temperature. The solvent was removed *in vacuo* and water was added to the remaining solution to dissolve the PEG product. The solution was centrifuged at 20K rcf for 10 minutes, whereupon the adamantane-methylamine phase-separated as a denser liquid. The aqueous portion was collected and water removed *in vacuo*.  
15 The remaining viscous liquid was redissolved in 20% piperidine in DMF for Fmoc deprotection and stirred for 30 minutes at room temperature. The solvent was removed *in vacuo*, washed several times with DMF, redissolved in water, and run on an anionic exchange column to remove unreacted PEG. The first fractions were collected and lyophilized to yield 222 mg of a white, fluffy powder (76% yield) of the desired product which was confirmed by MALDI-TOF analysis.

20

*2. Synthesis of N-Hydroxysuccinimide-folate (NHS-folate)*

Scheme XXXXIX

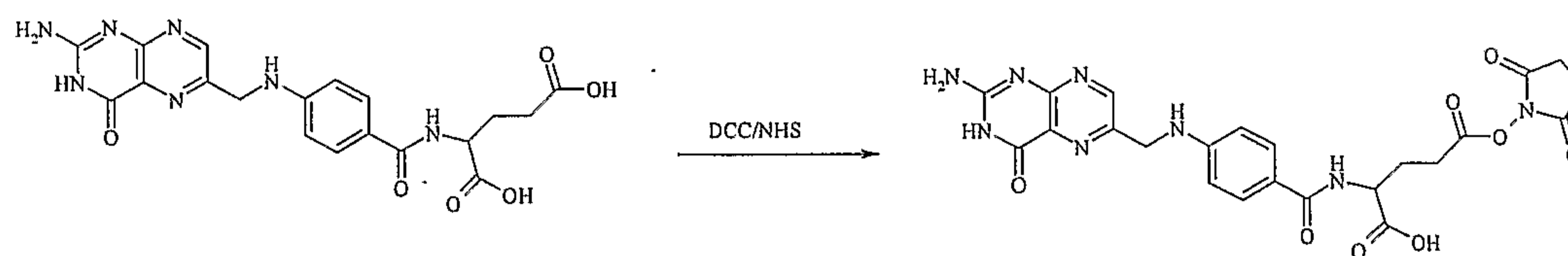

NHS-folate is synthesized according to the method of Lee and Low (Lee, R. J; Low, P. S. *J. Biol. Chem.* **1994**, *269*, 3198-3204). Folic acid (5 g, 11.3 mmol;



Sigma) is dissolved in DMSO (100 ml) and triethylamine (2.5 ml) and reacted with N-hydroxysuccinimide (2.6 g, 22.6 mmol) and dicyclohexylcarbodiimide (4.7 g, 22.7 mmol) over-night at room temperature. The solution is filtered and concentrated under reduced pressure. NHS-folate is precipitated using diethyl ether (yellow-orange precipitate), and washed 2-3 times in anhydrous ether, dried under vacuum, and stored at  $-20\text{ }^{\circ}\text{C}$ .

### 3. AD-Peg<sub>5000</sub>-Folate

#### Scheme L

10

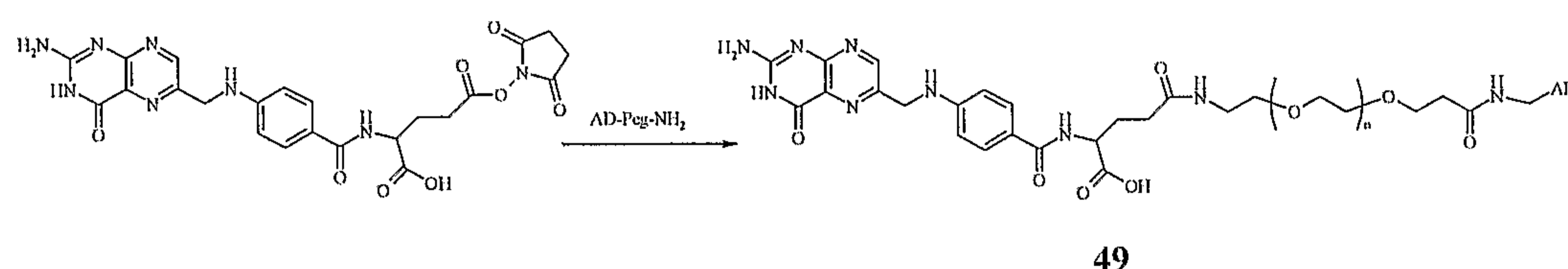

AD-Peg5000-NH<sub>2</sub> and NHS-Folate are mixed at 1:1 eq. in DMSO solution. DIEA (2 eq) is added. The mixture is allowed to stir at room temperature for overnight. The DMSO solution is then dialyzed against 3500 MWCO (Spectra/Por 7) membrane for 48 hours. AD-Peg5000-Folate **49** is obtained after lyophilization.

**Example 41:** Formulation of the AD-Peg-Folate and a CD-Polymer-CPT conjugate  
A typical procedure: A CD-polymer CPT conjugate is dissolved in a D5W buffer. A D5W solution containing 0.1-1 eq (mols of repeat unit) of AD-Peg-Folate solution is added to polymer solution. Particle sizes of polymer are measured before and after adding of AD-Peg-Folate using light scattering. This solution is used for either *in vitro* or *in vivo* test for the analysis of folate targeting effects.

25

**Example 42:** Covalent linking a targeting ligand (e.g., folate) to a CD-CPT polymer conjugate (eg PEI-CD-GlyCPT) **50**

#### Scheme LI

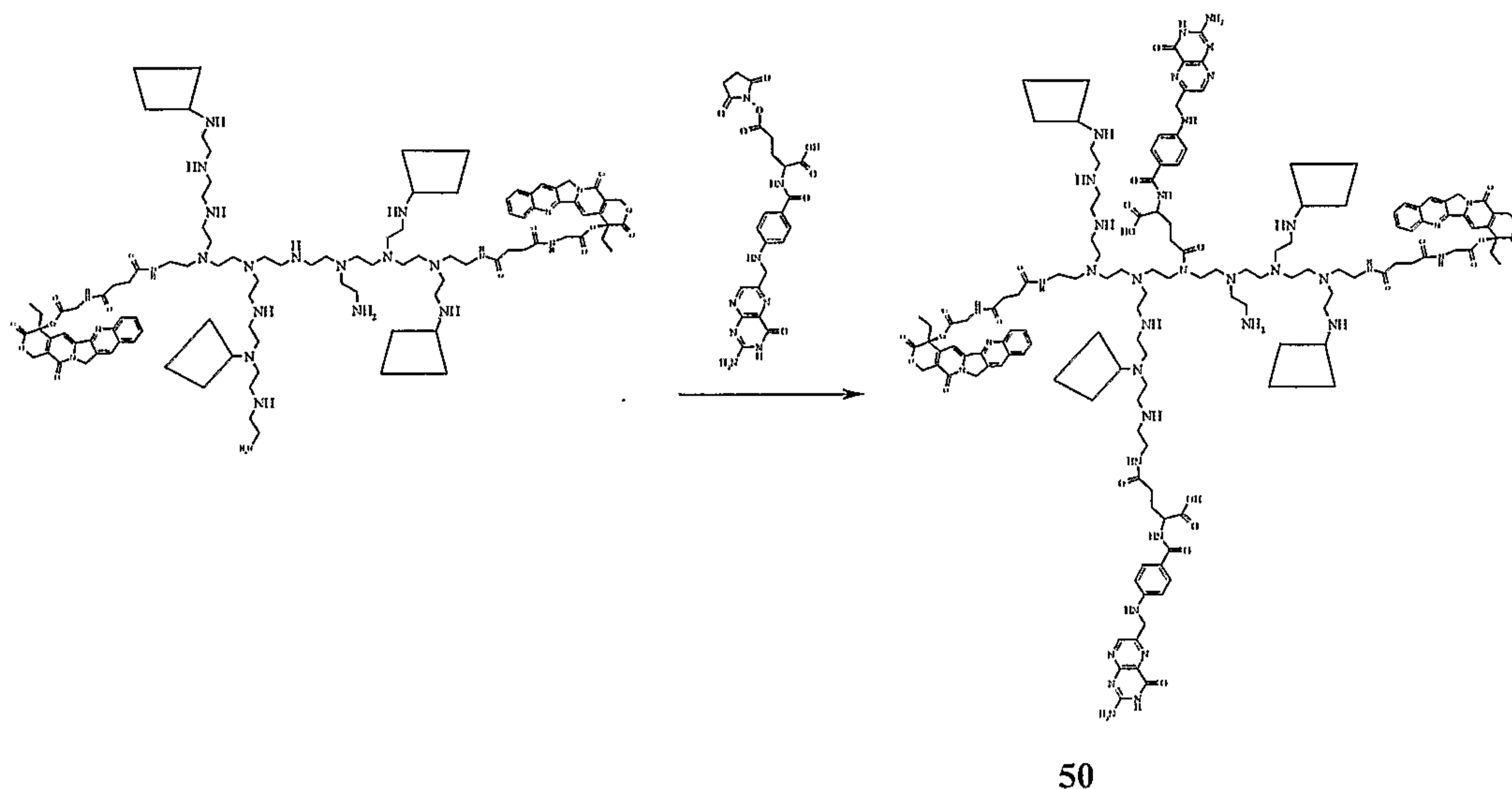

PEI-CD-GlyCPT **44** and Folate-NHS (0.1-0.5 eq) are mixed in DMSO and stirred  
 5 for 24 hours. The polymer is crashed out with ether and washed extensively with  
 this solvent until no free folate molecule can be detected. The resulting CD-  
 polymer-CPT-Folate conjugate **50** is dried under vacuum.

**Example 43:** Crosslinking of CD-CPT polymer using Ad-Peg-Ad. **51**

10 A typical procedure: AD-Peg-AD **45** (0.01-0.1 eq of CD-polymer repeat unit) and  
 CD-polymer CPT conjugate are mixed in a minimum amount of DMSO. The  
 resulting viscous solution is precipitated with ether and dried under vacuum to yield  
 lightly crosslinked polymer **51**. **51** should still maintain small particle size in  
 solution, have good water solubility, and have higher molecular weight than parent  
 15 CD-polymer CPT conjugate.

**Example 44:** In vivo tests of camptothecin polymer conjugates **HGGG6**, **LGGG10**,  
**HG6**, and **HGGG10** (Synthesized according to **Example 28**).

20 **A. In Vivo Toxicity and Blood Chemistry Analysis from Dosing With Parent  
 Polymer 36e**

The toxicity of **36e** and its effects on blood chemistry were evaluated in  
 female Charles River nude mice (13-14 weeks old). Four treatment groups of six  
 mice each were treated with a D5W solution of **36e** at a dose of 240 mg/kg, 160.



mg/kg, 80 mg/kg or D5W alone by i.v. tail vein injection on Days 1, 5, and 9, respectively. Dosing volume was determined based upon a ratio of 200  $\mu$ l for a 20 g mouse, and was scaled appropriately according to the actual BW of the mice. The BWs of the mice were followed daily for the first 5 days and then twice a week, 5 thereafter. Blood samples (150-200  $\mu$ l) were collected from each mouse by retro-orbital bleeding under isoflourane on Day 12. Samples from three mice in each group were used for complete blood count (CBC) analyses, while blood samples from the remaining three mice in each group were processed for blood chemistry analyses. The study was stopped at Day 23. All mice were euthanized by cardiac 10 puncture under CO<sub>2</sub>, and blood from each mouse was collected for CBC and blood chemistry analysis in the same manner as on Day 12.

There was no significant difference in BW loss, CBC or blood chemistry data between any of the **36e** treated groups and D5W control group throughout the study, and no time dependent effects were observed over 23 days for all the treated groups. 15 **36e** was well tolerated by mice at the maximum dose treated (240 mg/kg).

#### **B. Determination of Maximum Tolerable Dose (MTD) for CDP-CPT Conjugates.**

The MTD was determined using female Charles River nude mice (15–16 weeks old) 20 for **HG6**, **LGGG10**, **HGGG10**. A 5% (w/v) of dextrose solution (D5W) of the polymer-CPT conjugates was freshly prepared before each injection. Doses for the treatment groups ranged from 2.25 mg CPT/kg to 54 mg CPT/kg. Dosing was administered intravenously (i.v.) by tail vein injection on Days 1, 5, and 9. The dosing volume was determined based upon a ratio of 200  $\mu$ l for a 20 g mouse, and 25 was scaled appropriately according to actual body weight (BW) of the mice. Three to five mice were used in each treatment group. The BWs of the mice were followed daily for the first 5 days and then twice a week, thereafter. The MTD was defined as the highest administered dose that resulted in a decrease of mean group BW of less than 20% or the highest administered dose that did not result in death of any animal 30 in that group. The maximum mean body weight loss and treatment related deaths for all treated groups are listed in Table 5.

Table 5. Treatment response for the MTD study. Nude mice (n= 3-6) were treated i.v. by tail vein injection.

Agent	mg/kg <sup>a</sup>	Max %BW loss; Day <sup>b</sup>	N <sub>TR</sub> /N <sup>c</sup>
<b>D5W</b>	-	-2.5%; Day 3	0/6
<b>36e</b>	240	-2.0%; Day 3	0/6
<b>36e</b>	160	-3.5%; Day 13	0/6
<b>36e</b>	80	-2.3%; Day 3	0/6
<b>LGGG10</b>	54	-20.6%; Day 3	3/3
<b>LGGG10</b>	36	-9.3%; Day 13	0/3
<b>LGGG10</b>	18	0	0/3
<b>LGGG10</b>	9	0	0/5
<b>LGGG10</b>	4.5	-0.8%; Day 13	0/5
<b>HG6</b>	54	-28.5%; Day 3	3/3
<b>HG6</b>	36	-23.9%; Day 3	3/3
<b>HG6</b>	18	-22.1%; Day 3	3/3
<b>HG6</b>	9	-6.1%; Day 9	0/5
<b>HG6</b>	4.5	-4.4%; Day 5	0/5
<b>HG6</b>	2.25	-2.9%; Day 9	0/5
<b>HGGG10</b>	54	---	3/3
<b>HGGG10</b>	36	-34%; Day 5	3/3
<b>HGGG10</b>	18	-16%; Day 3	1/3
<b>HGGG10</b>	9	-3.3%; Day 9	0/5
<b>HGGG10</b>	4.5	-2.5%; Day 9	0/5

5 <sup>a</sup> Mg CDP /kg for the CDP polymer and mg CPT/kg for the three conjugates tested.

<sup>b</sup> Maximum body weight (BW) loss observed post injection

<sup>c</sup> Number of treatment-related deaths (N<sub>TR</sub>) to the number of mice treated (N)

10 The MTD of **LGGG10**, **HG6**, and **HGGG10** were determined to be 36 mg CPT/kg, 9 mg CPT/kg, and 9 mg CPT/kg, respectively. Based on the structural



similarities between **HGGG6** and **HGGG10**, it is expected that the MTD for these two groups are similar. Therefore, the MTD of **HGGG6** (not tested) was assumed to be 9 mg CPT/kg.

5

### C. Antitumor Efficacy Study.

The antitumor efficacy study was performed using female Charles River nude mice (15–16 weeks old). A fragment (1 mm<sup>3</sup>) of human LS174T colon carcinoma tissue was implanted subcutaneously (s.c.) into the right flank of each test mouse approximately 14-18 days before dosing. The tumor volume was determined by measuring the tumor in two dimensions with calipers and calculated using the formula: tumor volume = (length x width<sup>2</sup>)/2. Tumor volume was converted to tumor weight assuming 1 mm<sup>3</sup> is equal to 1 mg tumor in weight. Treatment was initialized when mean tumor size reached approximately 60-100 mg (Day 1). The animals were sorted into twelve groups. Each group consisted of seven mice with tumor sizes ranging from 62.5–144.0 mg with group mean tumor sizes of 88.6–90.7 mg. Mice in each group were treated according to the protocol listed in Table 6. All conjugate treatments were administered intravenously by tail vein injection. Tumor sizes were measured twice a week for the duration of the experiment. At the end of study, tumors from each euthanized mouse were harvested and frozen at –80 °C.

Table 6. Dosing protocol for efficacy study.<sup>a</sup>

Group	Agent	Dose (mg CPT/kg) <sup>b</sup>	Route <sup>c</sup>	Schedule <sup>d</sup>
1	D5W	-	i.v.	Q4D x 3
2	CPT	9	i.p.	Q4D x 2 <sup>e</sup>
3	Irinotecan	100 <sup>f</sup>	i.p.	Qwk x 3
4	<b>HGGG6</b>	9	i.v.	Q4D x 3
5	<b>HGGG6</b>	4.5	i.v.	Q4D x 3

6	<b>LGGG10</b>	36	i.v.	Q4D x 3
7	<b>LGGG10</b>	18	i.v.	Q4D x 3
8	<b>LGGG10</b>	9	i.v.	Q4D x 3
9	<b>HG6</b>	9	i.v.	Q4D x 3
10	<b>HG6</b>	4.5	i.v.	Q4D x 3
11	<b>HGGG10</b>	9	i.v.	Q4D x 3
12	<b>HGGG10</b>	4.5	i.v.	Q4D x 3

<sup>a</sup> Seven mice were used in each group

<sup>b</sup> Doses are equivalent of CPT except for group 3

<sup>c</sup> i.p. = intraperitoneal, i.v. = intravenous

<sup>d</sup> Administration schedules were abbreviated as: Q4D x 3 = three injection with  
 5 four-day intervals, Qwk x 3 = three injection with one-week interval, first dose was initialized on day 1 for all groups.

<sup>e</sup> The scheduled third dose was not given due to the emerging toxicity

<sup>f</sup> 100 mg irinotecan/kg

10

Each animal was euthanized when tumor weight reached the predetermined endpoint size (1,500 mg). The time-to-endpoint (TTE) for each mouse was calculated from the equation:  $TTE = (\log(\text{endpoint}-b))/m$ , where b and m are the intercept and the slope, respectively, of the line obtained by linear regression of a  
 15 log-transformed tumor growth data set comprised of the first observation that exceeded the study endpoint volume and the three consecutive observations that immediately preceded the attainment of the endpoint volume. Animals that do not reach the endpoint were assigned a TTE value equal to the last day of the study (114 days). Animals classified as treatment-related deaths (TR) were assigned a TTE  
 20 value equal to the day of death. Animals classified as non-treatment-related death (NTR) are excluded from TTE calculations. Tumor growth delay (TGD), defined as the increase in the median time to endpoint (TTE) in a treatment group compared to the control group, was one parameter investigated to evaluate treatment efficacy.



TGD is calculated as the difference between the median TTE for a treatment group and the median TTE of the control group ( $TGD = T - C$ ) and is expressed in days, and as a percentage of the median TTE of the control group;  $\%TGD = (T-C)/C$  where T is equal to median TTE for a treatment groups and C is equal to median TTE for the control, Group 1.

**Toxicity.** Animals were weighed daily on Days 1–5, then twice weekly thereafter. Mice were examined frequently for overt signs of any adverse, drug-related side effects. Acceptable toxicity for cancer drugs in mice is defined by the NCI as a group mean body-weight loss of less than 20% during the study, and not more than one toxic death among seven treated animals.

Results for this efficacy study that include median TTE values, median tumor burden on day 114, treatment response and deaths are summarized in Table 7.

Table 7.

Group	Median TTE <sup>a</sup>	T-C <sup>b</sup>	%TGD <sup>c</sup>	Median Tumor Burden in mg (N <sub>s</sub> <sup>d</sup> )	N <sub>TR</sub> <sup>e</sup> / N <sub>NTR</sub> <sup>f</sup> / N <sub>EU</sub> <sup>g</sup>	P vs D5W <sup>h</sup>	P vs CPT <sup>i</sup>
1	34.9	-	-	-(0)	0/1/6	-	-
2	51.4	16.5	47%	-(0)	2/0/5	0.2128	-
3	68.7	33.8	97%	1152 (3)	0/0/4	0.0002	0.0253
4	114.0	79.1	227%	256 (5)	1/0/1	0.0040	0.0115
5	65.6	30.7	88%	566 (2)	0/1/4	0.0046	0.1369
6	100.0	65.1	187%	666 (3)	4/0/0	0.0272	0.0289
7	75.6	40.7	117%	221 (3)	0/0/4	0.0018	0.0601
8	63.2	28.3	81%	700 (1)	1/0/5	0.0006	0.1064
9	114.0	79.1	227%	394 (4)	0/0/3	0.0002	0.0028
10	74.2	39.3	113%	668(2)	1/1/3	0.0016	0.0673
11	114.0	79.1	227%	500 (5)	1/0/1	0.0040	0.0050
12	78.0	43.1	123%	1010 (2)	0/0/6	0.0006	0.0392

<sup>a</sup>TTE = Time (Days) to endpoint (1500 mg)

<sup>b</sup> T-C = Difference between TTE (Days) of treated versus control group

<sup>c</sup> %TGD = [(T-C)/C]

<sup>d</sup> Mice surviving

<sup>e</sup> N<sub>TR</sub> = Number of treatment-related death

5 <sup>f</sup> N<sub>NTR</sub> = Number of non-treatment-related death

<sup>g</sup> N<sub>EU</sub> = Number of mice euthanized after reaching endpoint

<sup>h</sup> P value versus the D5W treatment group (Group 1)

<sup>i</sup> P value versus the CPT treatment group (Group 2)

10 One NTR death on day 72 was observed in the control animals treated with D5W. Tumors in the other six control mice grew to the 1500 mg endpoint size, yielding a median TTE of 34.9 days (Table 7).

Two treatment-related deaths were reported on Day 9 for CPT at 9 mg/kg. Thus, CPT must be considered to be toxic at this dose in this experiment. The median TTE  
15 for this group was 51.4 days, corresponding to a 16.5 day T-C and a 47% TGD, relative to untreated control mice (*not significant*). No animal in Group 2 survived to Day 114.

Group 3 received irinotecan i.p. at 100 mg/kg (Qwk x 3). The median TTE for Group 3 was 68.7 days, corresponding to a significant 33.8 day T-C and a 97%  
20 TGD, relative to control mice ( $P < 0.01$ ). Three animals survived to Day 114 with a median tumor burden of 1,152 mg. No regressions were recorded.

Groups 4 and 5 received **HGGG6** i.v. Q4D x 3 at 9 and 4.5 mg CPT/kg, respectively. One treatment-related death was observed on Day 16 in Group 4, and one NTR death was recorded on Day 37 in Group 5. The median TTE for Group 4  
25 was 114 days, the maximum possible value in this study. This TTE value corresponds to a significant 79.1 day T-C and a 227% TGD, relative to control ( $P < 0.01$ ). Tumors in five mice of Group 4 did not reach the 1,500 mg endpoint. These five mice had a median tumor burden of 256 mg on Day 114. The median TTE for Group 5 was 65.6 days, and corresponds to a significant 30.7 day T-C and an 88%  
30 TGD, relative to control ( $P < 0.01$ ).

Groups 6-8 were treated with **LGGG10** i.v. Q4D x 3 at 36, 18, and 9 mg CPT/kg, respectively. Although no death was observed in MTD study using this



conjugate in non-tumor bearing mice at 36 mg CPT/kg (Table 5), four treatment-related deaths were recorded in Group 6 when tumor-bearing mice were given at this dose, two on Day 16 and one each on Days 75 and 100. These results indicate that 36 mg CPT/kg is probably over the MTD of **LGGG10**. As shown in Table 5, no significant body weight loss was recorded in the MTD study when the mice were dosed at 18 mg CPT/kg, indicating that this dose is below the MTD. Therefore, the MTD of **LGGG10** lies somewhere between 18 to 36 mg CPT/kg. The median TTE for Group 7 (18 mg CPT/kg) was 75.6 days. This TTE value corresponds to a significant 40.7 day T-C and a 117% TGD, relative to control mice ( $P < 0.01$ ). Three mice in this group had a median tumor burden of 221 mg on Day 114. One late TR death was recorded on Day 103 in Group 8 (9 mg CPT/kg). The median TTE for Group 8 was 63.2 days. This TTE value corresponds to a significant 28.3 day T-C and an 81% TGD, relative to untreated control mice ( $P < 0.01$ ). The remaining mouse in this group had a tumor burden of 700 mg on Day 114.

Groups 9 and 10 were dosed with **HG6** i.v. Q4D x 3 at 9 and 4.5 mg CPT/kg, respectively. One TR and one NTR death were recorded in Group 10 on Days 47 and 84, respectively. The median TTE for Group 9 was the maximum, 114 days. This TTE value corresponds to a significant 79.1 day T-C and a 227% TGD, relative to untreated control mice ( $P < 0.01$ ). Four mice in Group 9 had a median tumor burden of 394 mg on Day 114. The median TTE for Group 10 was 74.2 days. This TTE value corresponds to a significant 39.3 day T-C and a 113% TGD, relative to control mice ( $P < 0.01$ ). The remaining two mice in Group 10 had a median tumor burden of 668 mg on Day 114.

Groups 11 and 12 were dosed with **HGGG10** i.v. Q4D x 3 at 9 and 4.5 mg CPT/kg, respectively. One treatment-related death was recorded on Day 16 in Group 11. The median TTE for Groups 11 and 12 were 114 days and 78 days, respectively. The TTE value for Group 11 corresponds to a significant 79.1 day T-C and a 227% TGD, relative to control mice ( $P < 0.01$ ). Tumors in five mice in Group 11 did not reach the endpoint; these five mice had a median tumor burden of 500 mg on Day 114. The TTE value of Group 12 corresponds to a significant 43.1 day T-C and a 123% TGD, relative to control mice ( $P < 0.01$ ). The remaining two mice in this group had a median tumor burden of 1,010 mg on Day 114.

The tumor growth curve as a function of time for the D5W, CPT, irinotecan, **LGGG10** at its highest non-toxic dose tested (18 mg CPT/kg), and the other three conjugates with high MW polymer (**HGGG6**, **HG6**, **HGGG10**) at their MTDs are shown in Figure 8. The three high MW conjugates administered at their MTDs  
5 displayed more prolonged tumor growth inhibition compared to D5W, CPT and irinotecan. The median tumor growth curves for **HGGG6**, **HG6** and **HGGG10** that are illustrated in Figure 9 show that there is a distinct dose response for all three of these polymers when dosed as their MTD and at half of their MTD. The medium tumor growth curves for **LGGG10** and **HGGG10** each dosed at 9 mg CPT/kg as  
10 illustrated in Figure 10 demonstrate that high MW polymer-drug conjugate has greater antitumor effect when compared to the low MW conjugates presumably due to the enhanced accumulation (EPR effect) and reduced renal clearance.

**Mean Body Weight Loss of Mice.** Mean body weight (MBW) losses as a function of time are plotted for D5W, CPT, irinotecan and the three conjugates  
15 containing high MW polymer at their MTDs (Fig. 11). Maximum MBW losses observed in Group 2 (CPT) and the two conjugates with the triglycine linker dosed at their MTDs (Groups 4 and 11) were 13.1%, 18.3%, and 12.6%, respectively. Maximum MBW loss of **HG6** (3.4%), the only conjugate with a glycine linker, was similar to the maximum MBW loss recorded for irinotecan (5.0%). Negligible  
20 (<5%) maximum group mean body-weight losses were recorded in all the other treatment groups and in the D5W group. Mean body weight returned to baseline levels for all treatment groups following cessation of therapy.

#### **D Correlation of Tumor size of euthanized mouse and the CPT concentration in 25 corresponding tumor.**

Each tumor harvested from mice at the completion of the LS174t xenograft mouse study was thawed and placed in a 2 ml lysis tube (Lysing Matrix D, Qbiogen). 300  $\mu$ L of lysis reagent (Cellytic -MT Mommalian Tissue  
30 Lysis/Extraction reagent) was added to each tube. The tissue was homogenized on a FastPrep FP12 homogenizer (Qbiogen) at 5 m/s for 40 sec. Homogenization was repeated six times with a 10 min interval between successive homogenization. The



homogenized solution was centrifuged at 14000g for 15 min at 10°C. 90 µL of the solution was syringed out to which 10 µL 1N NaOH was added. An aliquot of 400 µL MeOH was added to this solution after allowing the homogenized solution to stand for 2h at room temperature. The solution was centrifuged for 15 min at 14000 g. The supernatant (270 µL) was mixed with 30 µL 1N HCl and injected into an HPLC for analysis. The correlation of CPT concentration (ng/mg tissue) to tumor size (in mg) is illustrated in Figure 12. CPT concentration was inversely correlated to tumor size.

**Example 45:** Synthesis of Poly(CDDC-PEG)-Amphotericin B **52** via amide linker  
Scheme LII

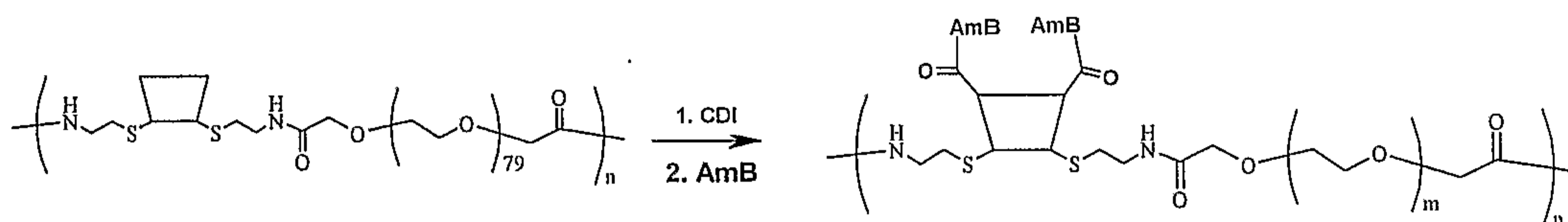

**52**

Poly(CDDC-PEG) (788 mg) and 1,1'-carbonyl diimidazole (CDI, 1.45 g, 50 eq.) were stirred in anhydrous DMSO (10 mL) in the presence of DMAP (429 mg, 20 eq) for 16 h. Ether (200 mL) was added to the mixture to precipitate poly(CDDC-PEG)-carbonyl-imidazole. The resulting yellow solid was washed with ether 2 x 200 mL and dried under vacuum. The solid was dissolved in anhydrous DMSO (15 mL), followed by adding AmB (332 mg, 2 eq) and DMAP (43.0 mg, 20 eq). The solution was stirred in dark for 48 h and dialyzed in water using 25000 MWCO membrane for 3 days. The solution was then filtered using 0.2 µm filter and lyophilized. A yellow solid (920 mg) **52** was obtained. The wt% of AmB is around 13%.

**Example 46:** Synthesis of Poly(CDDC-PEG)-Amphotericin B **53** via imine linker  
25

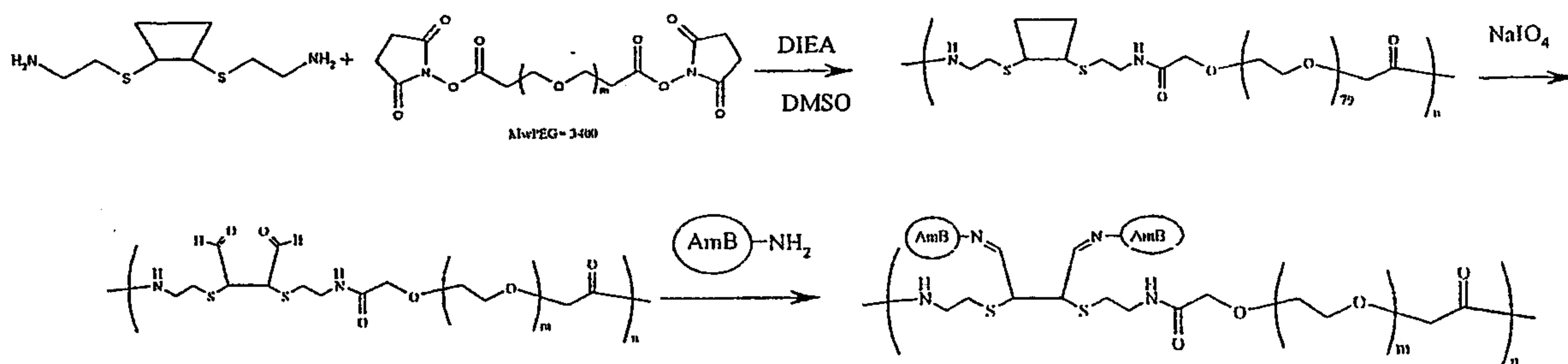

53

3 and PEG-DiSPA (1:1 ratio) were dried under vacuum at room temperature. DMSO (10 mg of 3/mL DMSO) was added to the solid and followed by adding of DIEA (2 eq) to the mixture. Polymer was crashed out with excess ether 5 days later and dialyzed using 25000 MWCO membrane for 48 h. The yield of poly(CDDC-PEG) is 80-95%. The Mw of polymer was determined using GPC to be 70-100 kDa.

Poly(CDDC-PEG) (1.124g, 0.25 mmol) was dissolved in water (55 mL). NaIO<sub>4</sub> (0.264g, 5 eq.) was added. The solution was stirred in dark at room temperature for 20 min and stored at 4 °C for 24h in dark. BaCl<sub>2</sub> solution was added (5.05 eq) to the solution to give immediate precipitation of Ba(IO<sub>4</sub>)<sub>2</sub>. The precipitate was filtered. Saturated Na<sub>2</sub>CO<sub>3</sub> solution was added to adjust pH to 11. Amphotericin B (343mg, 1.5 eq) was then added to solution and stirred at rt in dark for 48h. The pH of solution was maintained to be 11 by adding NaOH (0.1N) throughout the reaction. The solution was dialyzed at 4 °C for 48 h using 25000 MWCO and lyophilized to give 1.03 g polymer-AmB conjugate 53 as a yellow powder. The wt% of AmB is determined to be 18 using UV spectrometer at 405 nm.

20

#### D. References

Additional cyclodextrin-containing polymers that can be modified according to the teachings of the present invention, as well as methods of preparing such polymers, are disclosed in U.S. Patents 6,509,323; 7,091,192; 7,375,096; 7,166,302 and 7,018,609.

25



**CLAIMS:**

1. A linear, water-soluble, cyclodextrin-containing polymer, comprising cyclodextrin moieties alternating with linker groups in a polymer chain, wherein a plurality of therapeutic agents is covalently attached to the polymer, wherein the therapeutic agents are cleaved under biological conditions to release the therapeutic agents, wherein administration of the polymer to a patient results in release of the therapeutic agents, wherein the linear, water-soluble, cyclodextrin-containing polymer comprises at least four cyclodextrin moieties alternating with at least four linker groups.

2. The polymer of claim 1, represented by Formula I:

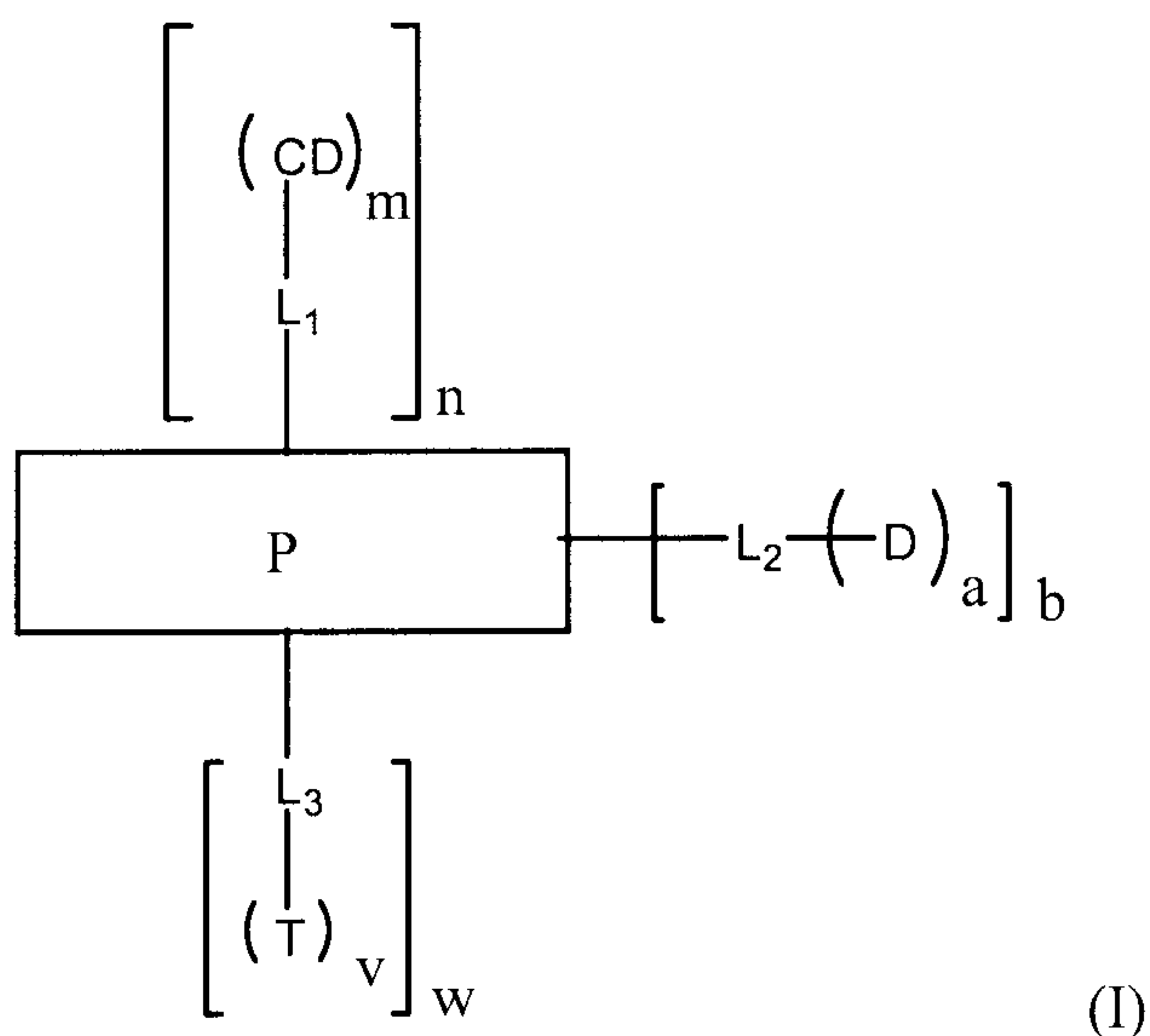

wherein

P represents the linear, water-soluble, cyclodextrin-containing polymer, comprising four cyclodextrin moieties alternating with linker groups in the polymer chain;

CD represents an additional cyclodextrin moiety;

L<sub>1</sub>, L<sub>2</sub> and L<sub>3</sub>, independently for each occurrence, may be absent or represent side linkers;

D, independently for each occurrence, represents a therapeutic agent or a prodrug thereof;

T, independently for each occurrence, represents a targeting ligand or precursor thereof;

a, m, and v, independently for each occurrence, represent integers in the range of 1 to 10;  
 n and w, independently for each occurrence, represent an integer in the range of 0 to about 30,000; and  
 b represents an integer in the range of 2 to about 30,000.

3. The polymer of claim 2, wherein the polymer chain (P) comprises n' units of U, wherein n' represents an integer in the range of 2 to about 30,000, and U is represented by the general formula:

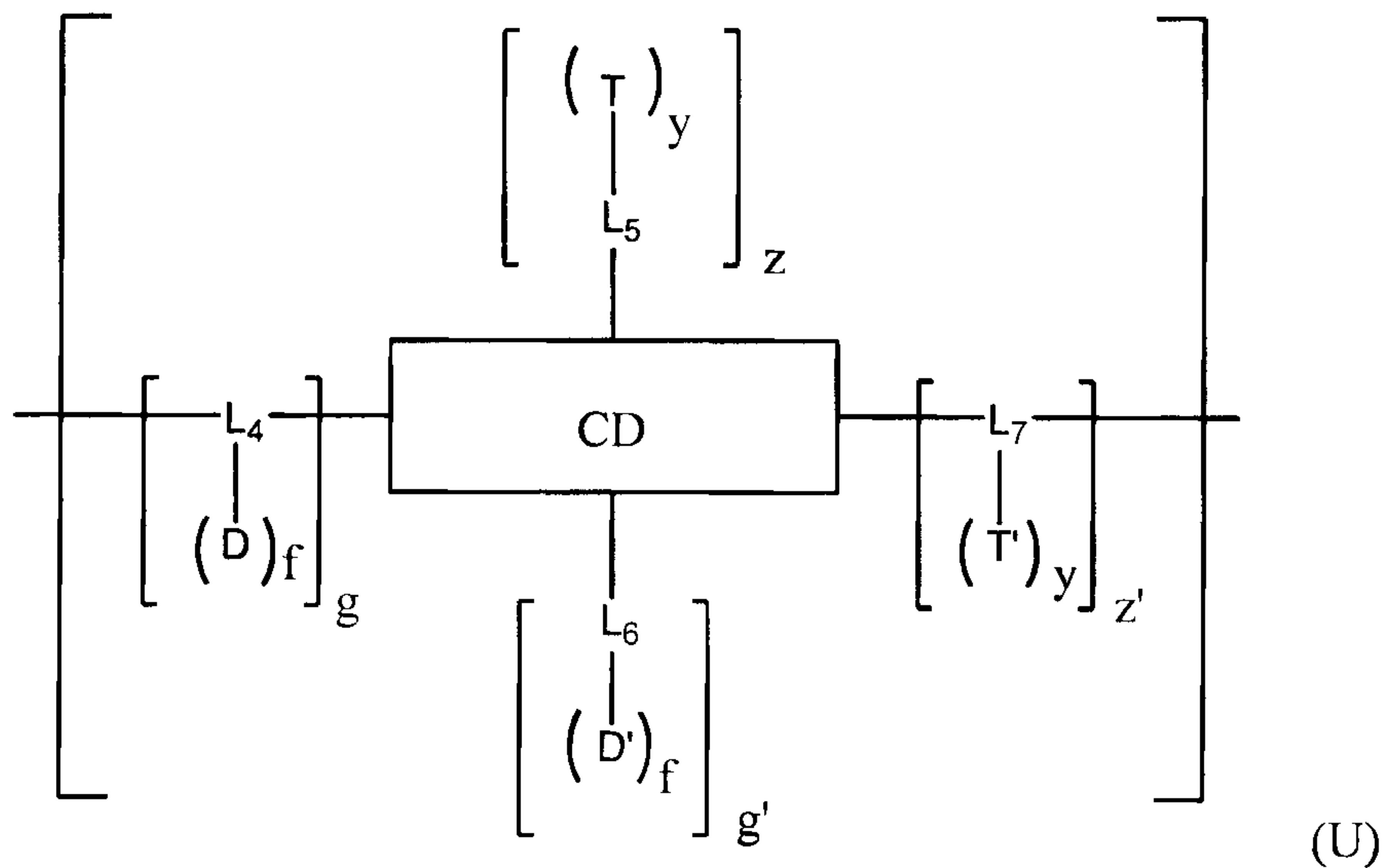

wherein

CD represents a cyclodextrin molecule, or derivative thereof;

L<sub>4</sub>, independently for each occurrence, represents a linker group;

L<sub>5</sub> and L<sub>6</sub>, independently for each occurrence, may be absent or represent side linkers;

L<sub>7</sub>, independently for each occurrence, may be absent or represent a linker group;

D and D', independently for each occurrence, represent the same or different therapeutic agents or prodrugs thereof;

T and T', independently for each occurrence, represent the same or different targeting ligands or precursor thereof;

f and y, independently for each occurrence, represent an integer in the range of 1 and 10; and



g, independently for each occurrence, represents an integer in the range of 1 and 10;

g', z, and z', independently for each occurrence, represent an integer in the range of 0 and 10.

4. The polymer of claim 1, comprising Formula III:

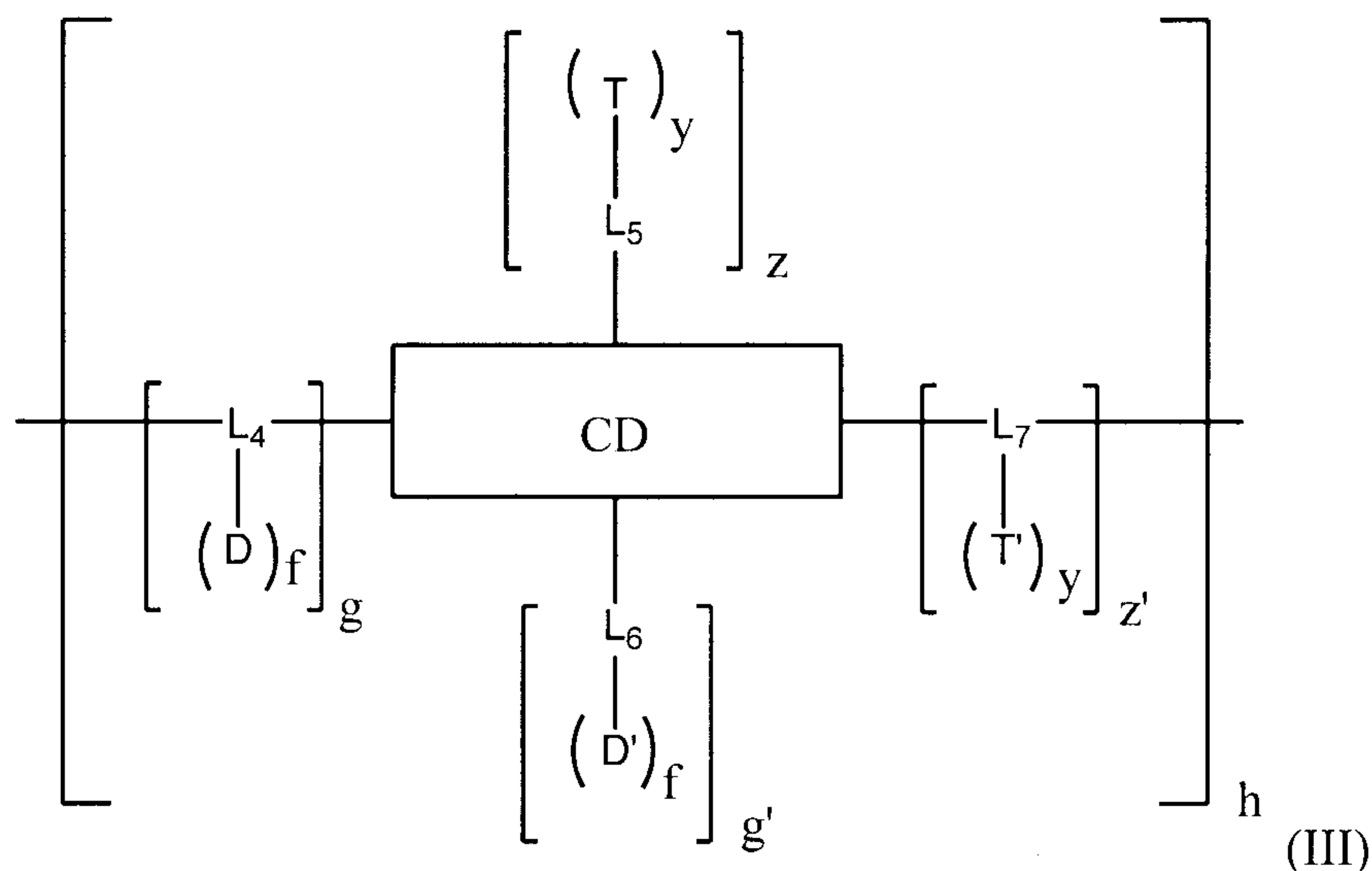

wherein

CD represents a cyclodextrin molecule, or derivative thereof;

L<sub>4</sub>, independently for each occurrence, represents a linker group;

L<sub>5</sub> and L<sub>6</sub>, independently for each occurrence, may be absent or represent side linkers;

L<sub>7</sub>, independently for each occurrence, may be absent or represent a linker group;

D and D', independently for each occurrence, represent the same or different therapeutic agents or prodrugs thereof;

T and T', independently for each occurrence, represent the same or different targeting ligands or precursor thereof;

f and y, independently for each occurrence, represent an integer in the range of 1 and 10;

h represents an integer in the range of 1 to about 30,000; and

g, independently for each occurrence, represents an integer in the range of 1 to 10;

g', z, and z', independently for each occurrence, represent an integer in the range of 0 and 10.

5. A linear cyclodextrin-containing polymer for use in therapy, wherein the linear cyclodextrin-containing polymer comprises at least four cyclodextrin moieties alternating with at least four linker groups, wherein said polymer is a compound represented by Formula IV, wherein more than one therapeutic agent D is covalently attached via a biohydrolyzable bond:

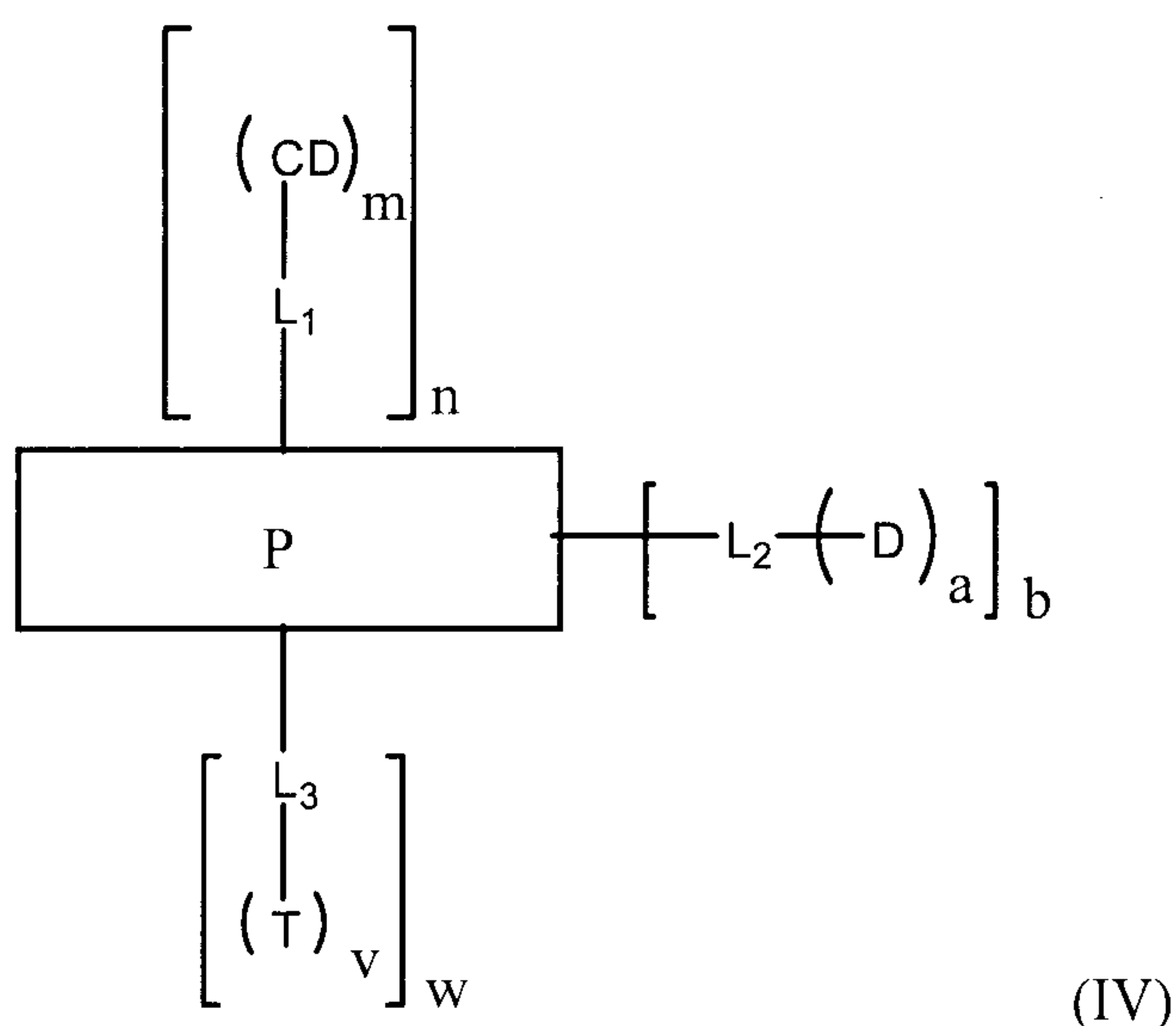

wherein

P represents a linear or branched polymer chain;

CD represents a cyclodextrin moiety;

L<sub>1</sub>, L<sub>2</sub> and L<sub>3</sub>, independently for each occurrence, may be absent or represent a linker group;

D, independently for each occurrence, represents said therapeutic agent;

T, independently for each occurrence, represents a targeting ligand or a precursor thereof;

a, m, and v, independently for each occurrence, represent integers in the range of 1 to 10;

n and w, independently for each occurrence, represent an integer in the range of 0 to about 30,000; and

b represents an integer in the range of 1 to 30,000;

wherein the polymer P comprises cyclodextrin moieties alternating with the linker groups in the polymer chain.



6. The polymer for use of claim 5, wherein the polymer chain comprises  $n'$  units of U, wherein  $n'$  represents an integer in the range of 1 to 30,000; and U is represented by the general formula:

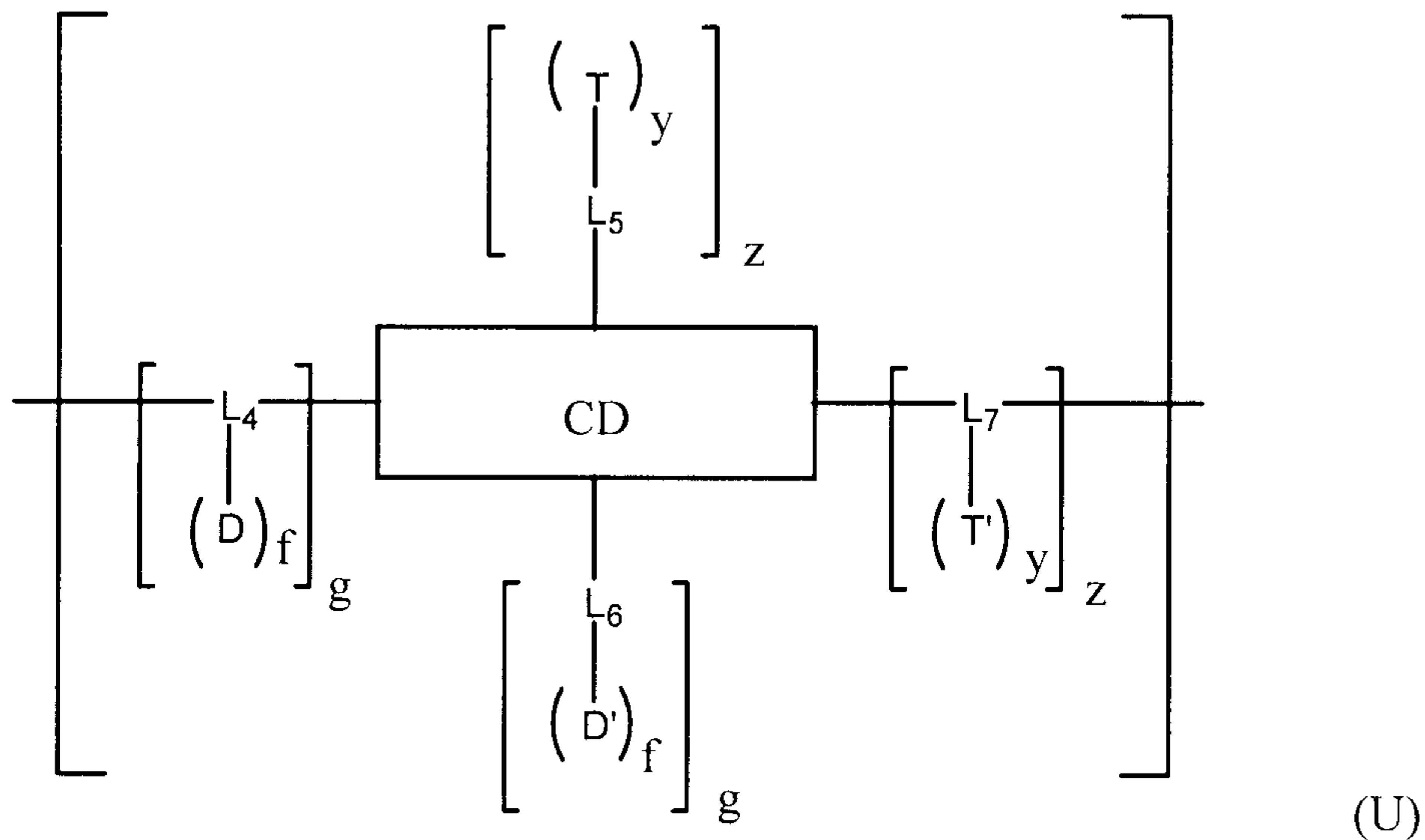

wherein

CD represents a cyclodextrin molecule;

$L_4$ ,  $L_5$ ,  $L_6$ , and  $L_7$ , independently for each occurrence, may be absent or represent a linker group;

D and D', independently for each occurrence, represent the same or different therapeutic agents;

T and T', independently for each occurrence, represents the same or different targeting ligands;

f and y, independently for each occurrence, represent an integer in the range of 1 and 10; and g and z, independently for each occurrence, represent an integer in the range of 0 and 10.

7. The polymer for use of claim 5, wherein the polymer is a linear polymeric compound represented by Formula V:

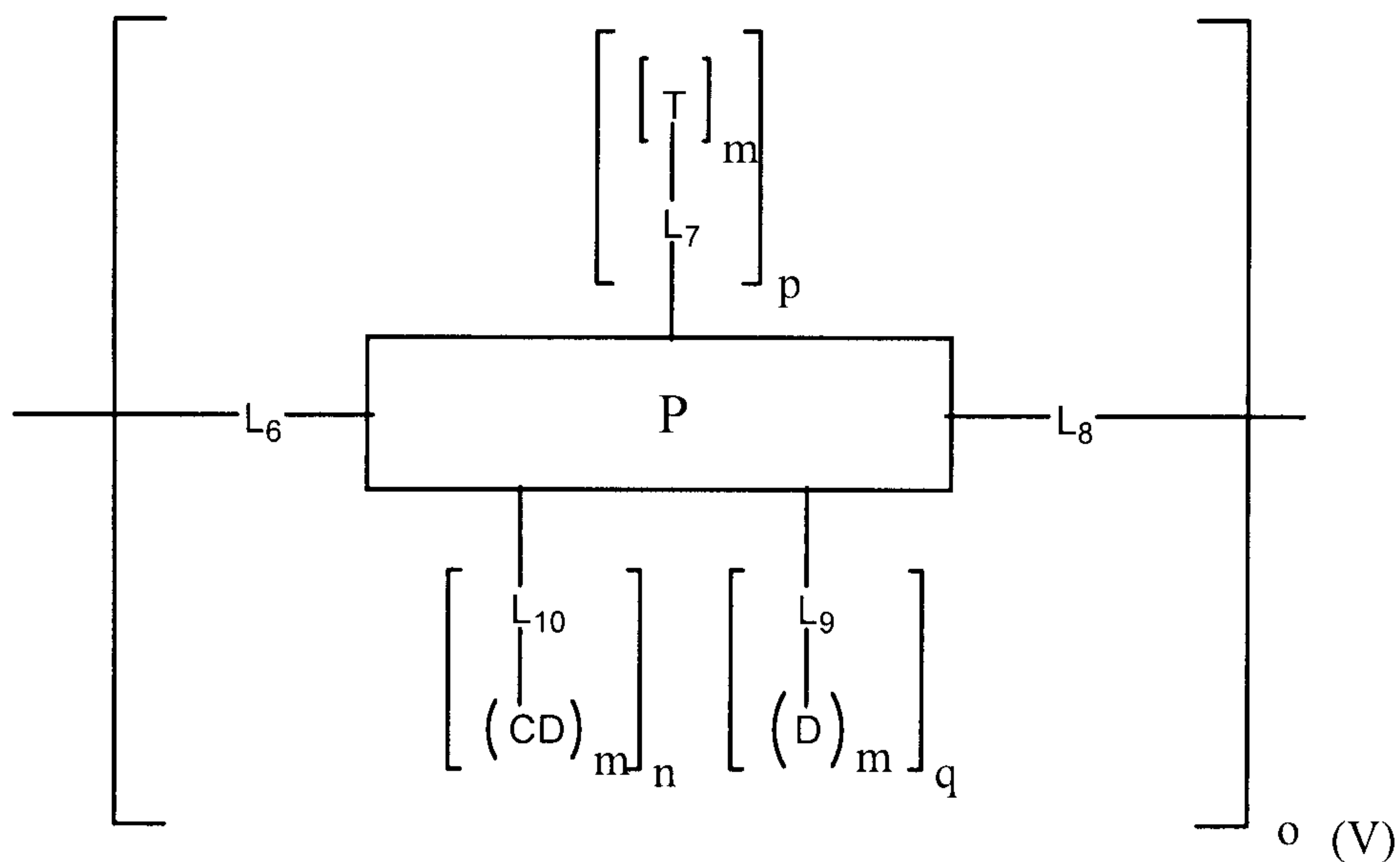

wherein

P represents a monomer unit of a polymer;

T, independently for each occurrence, represents a targeting ligand or a precursor thereof;

L<sub>6</sub>, L<sub>7</sub>, L<sub>8</sub>, L<sub>9</sub>, and L<sub>10</sub>, independently for each occurrence, may be absent or represent a linker group;

CD, independently for each occurrence, represents a cyclodextrin moiety;

D, independently for each occurrence, represents a therapeutic agent;

m, independently for each occurrence, represents an integer in the range of 1 to 10;

o represents an integer in the range of 4 to 30,000; and

p, n, and q, independently for each occurrence, represent an integer in the range of 0 to 10, and wherein CD and D are each present at least once in the compound.

8. The polymer for use of claim 5, wherein the polymer is a linear polymeric compound represented by Formula VI:



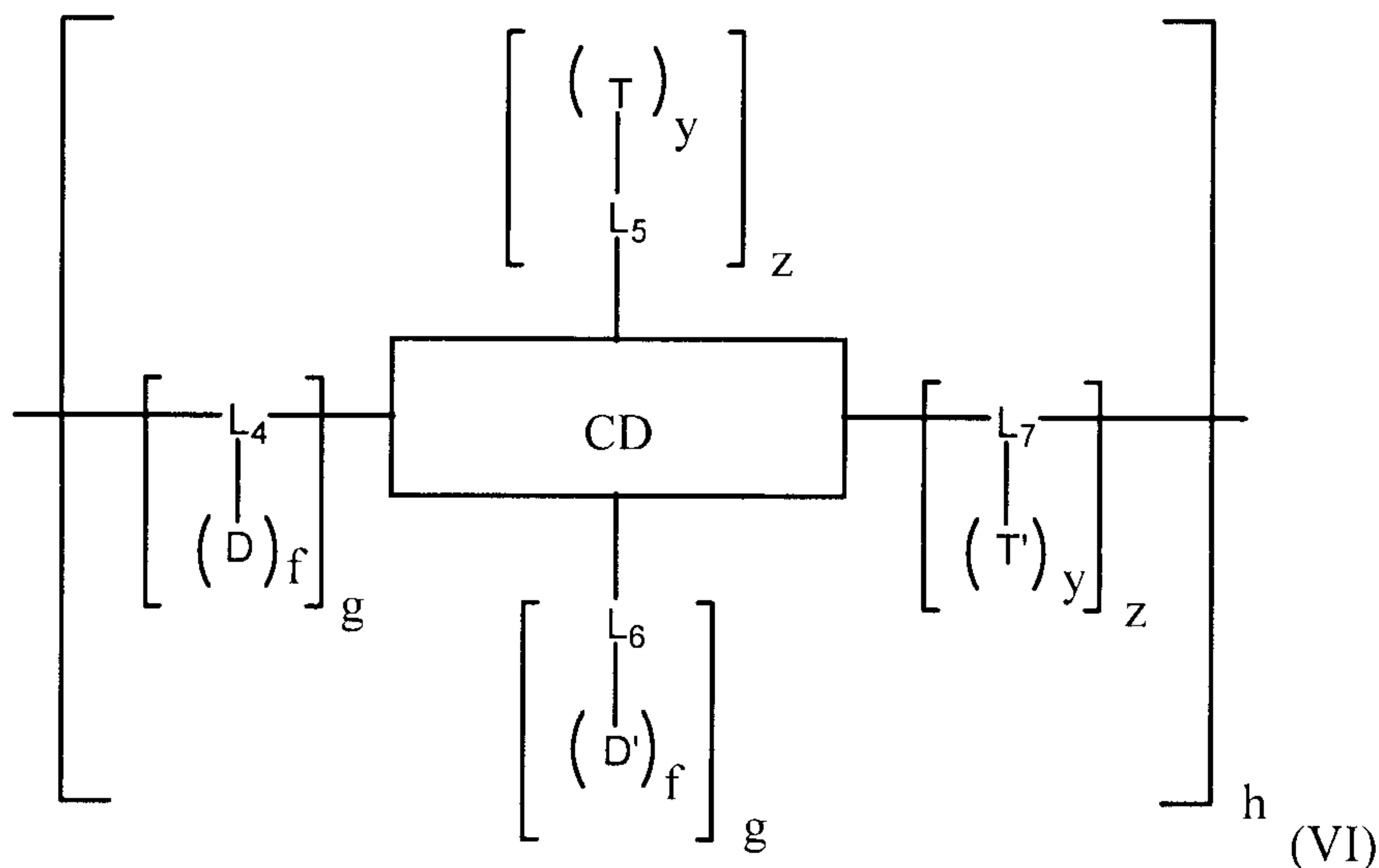

wherein

CD represents a cyclodextrin moiety;

$L_4$ ,  $L_5$ ,  $L_6$ , and  $L_7$ , independently for each occurrence, may be absent or represent a linker group;

D and D', independently for each occurrence, represent the same or different therapeutic agents;

T and T', independently for each occurrence, represent the same or different targeting ligands or precursor thereof;

f and y, independently for each occurrence, represent an integer in the range of 1 and 10;

h represents an integer 4 to 30,000; and

g and z, independently for each occurrence, represent an integer in the range of 0 and 10, and wherein at least one occurrence of g represents an integer greater than 0.

9. The polymer of any one of claims 2 to 4, wherein the side linker or the linker group comprises a hydrocarbylene group wherein one or more methylene groups is optionally replaced by a group Y, provided that none of the Y groups are adjacent to each other, wherein each Y, independently for each occurrence, is selected from, substituted or unsubstituted aryl, heteroaryl, cycloalkyl, heterocycloalkyl, or -O-, C(=X), wherein X is  $NR_1$ , O, -OC(O)-,

-C(=O)O, -NR<sub>1</sub>-, -NR<sub>1</sub>CO-, -C(O)NR<sub>1</sub>-, -S(O)<sub>n</sub>-, wherein n is 0, 1, or 2, -OC(O)-NR<sub>1</sub>, -NR<sub>1</sub>-C(O)-NR<sub>1</sub>-, -NR<sub>1</sub>-C(NR<sub>1</sub>)-NR<sub>1</sub>-, and -B(OR<sub>1</sub>)<sub>n</sub>-; and R<sub>1</sub>, independently for each occurrence, represents H or a lower alkyl.

10. The polymer of any one of claims 1 to 9, wherein each of the therapeutic agents is attached via linker groups.

11. The polymer of any of claims 2 to 10, wherein the side linker or the linker group comprises an amino acid or peptide, or derivative thereof.

12. The polymer of claim 11, wherein the side linker or the linker group comprises glycine or cysteine.

13. The polymer of any one of claims 2 to 10, wherein the therapeutic agent or targeting ligand is covalently bonded to the side linker or the linker group via a biohydrolyzable bond.

14. The polymer of claim 13, wherein the biohydrolyzable bond is selected from an ester, amide, carbonate, or a carbamate.

15. The polymer of any one of claims 1 to 14, wherein each of the cyclodextrin moieties comprises an alpha-, beta-, or gamma-cyclodextrin moiety.

16. The polymer of claim 15, wherein each of the cyclodextrin moieties comprises beta-cyclodextrin moieties.

17. The polymer of claim 16, wherein the beta-cyclodextrin moieties are at least about 10% by weight of the polymer.

18. The polymer of claim 16, wherein the beta-cyclodextrin moieties are at least about 20% by weight of the polymer.



19. The polymer of claim 16, wherein the beta-cyclodextrin moieties are at least about 30% by weight of the polymer.
20. The polymer of any one of claims 1 and 10 to 19, wherein each of the linker groups alternating with the cyclodextrin moieties comprises a comonomer.
21. The polymer of claim 20, wherein the comonomer comprises residues of at least two functional groups through which reaction and linkage of the cyclodextrin monomers was achieved.
22. The polymer of claim 21, wherein the functional groups, which may be the same or different, terminal or internal, of the comonomer comprises an amino acid, imidazole, hydroxyl, thio, acyl halide,  $-\text{HC}=\text{CH}-$ ,  $-\text{C}\equiv\text{C}-$  group, or derivative thereof.
23. The polymer of any one of claims 20 to 22, wherein the comonomer comprises a group selected from the following:  
an alkylene chain,  
polysuccinic anhydride,  
poly-L-glutamic acid,  
poly(ethyleneimine),  
an oligosaccharide, or  
an amino acid chain.
24. The polymer of claim 20, wherein the comonomer comprises a polyethylene glycol.
25. The polymer of claim 24, wherein the polyethylene glycol has a molecular weight of 0.2 kDa to 5 kDa.

26. The polymer of claim 20, wherein the comonomer comprises a group selected from the following:

polyglycolic acid or polylactic acid chain.

27. The polymer of claim 20, wherein the comonomer comprises a hydrocarbylene group wherein one or more methylene groups is optionally replaced by a group Y (provided that none of the Y groups are adjacent to each other), wherein each Y, independently for each occurrence, is selected from, substituted or unsubstituted aryl, heteroaryl, cycloalkyl, heterocycloalkyl, or -O-, C(=X) (wherein X is NR<sub>1</sub>, O or S), -OC(O)-, -C(=O)O, -NR<sub>1</sub>-, -NR<sub>1</sub>CO-, -C(O)NR<sub>1</sub>-, -S(O)<sub>n</sub>- (wherein n is 0, 1, or 2), -OC(O)-NR<sub>1</sub>-, -NR<sub>1</sub>-C(O)-NR<sub>1</sub>-, -NR<sub>1</sub>-C(NR<sub>1</sub>)-NR<sub>1</sub>-, and -B(OR<sub>1</sub>)-, and R<sub>1</sub>, independently for each occurrence, represents H or a lower alkyl.

28. The polymer of any one of claims 20 to 27, comprising cyclodextrin moieties, comonomers, and therapeutic agents covalently attached to the polymer, which polymer may be formed via poly condensation of cyclodextrin moiety precursors and comonomer precursors which do not contain cyclodextrin moieties, wherein the therapeutic agents are cleaved from the polymer under biological conditions to release the therapeutic agents.

29. The polymer of any one of claims 1 and 10 to 28, wherein the polymer comprises

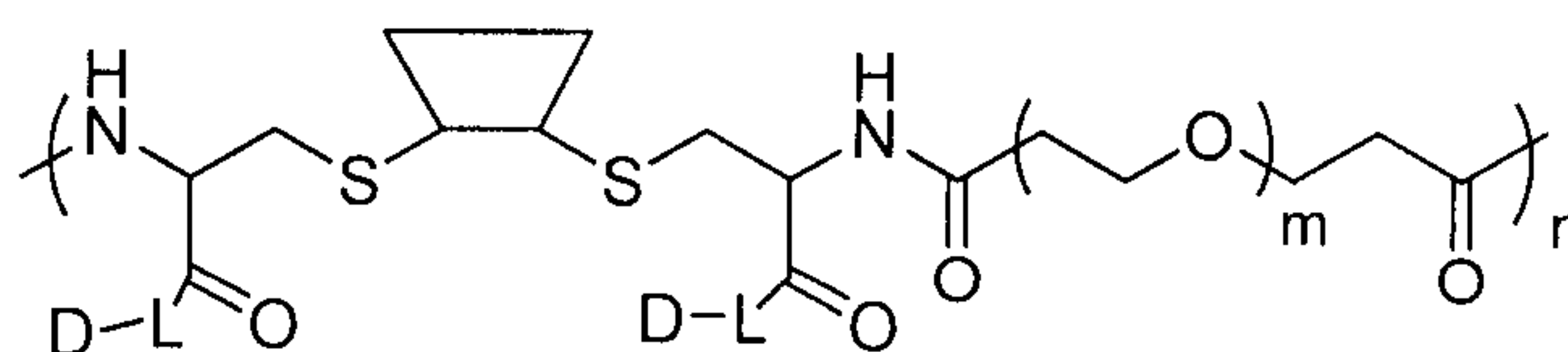

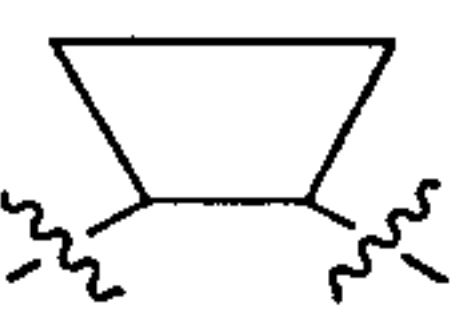
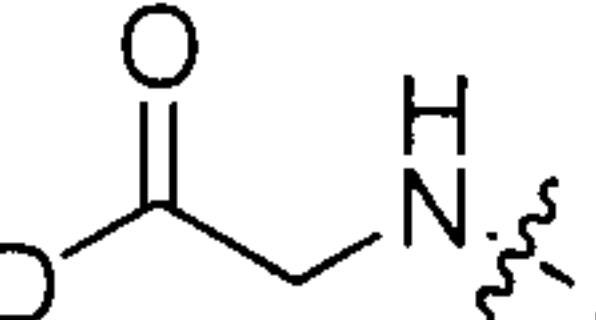
wherein  is a cyclodextrin, each D-L- is independently  or -OH, and each

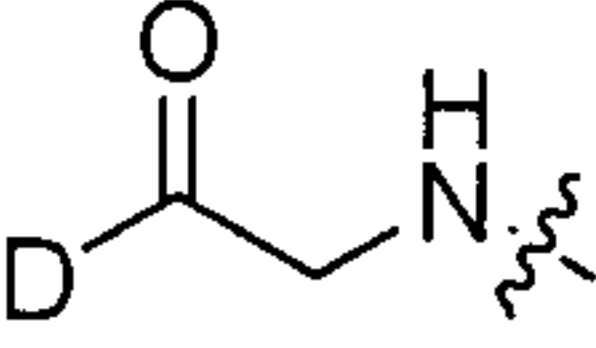
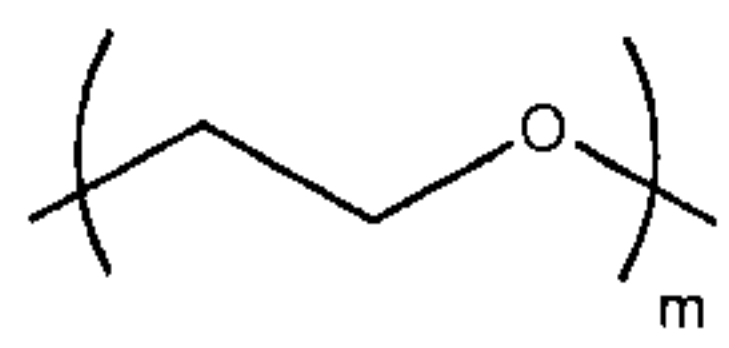
D is a therapeutic agent, wherein at least one D-L- is ,  has a Mw of 0.2 to 5kDa, and n is at least 4.



30. The polymer of any one of claims 1 and 10 to 28, wherein the polymer comprises a subunit having a formula:

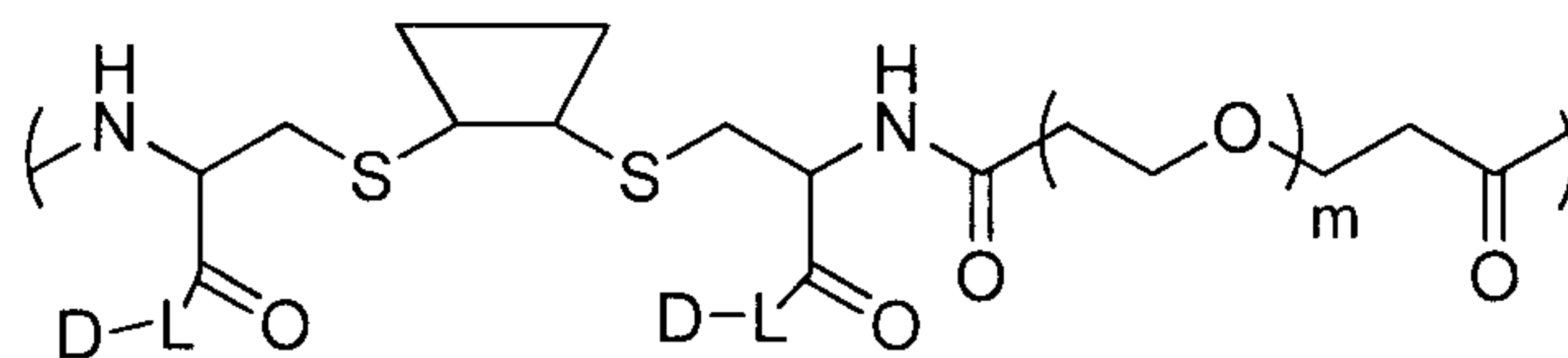

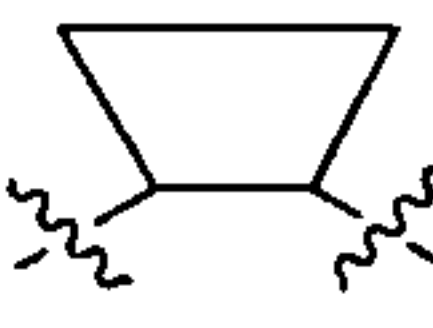
wherein each L is a biocleavable attachment, each D is a therapeutic agent,  is a

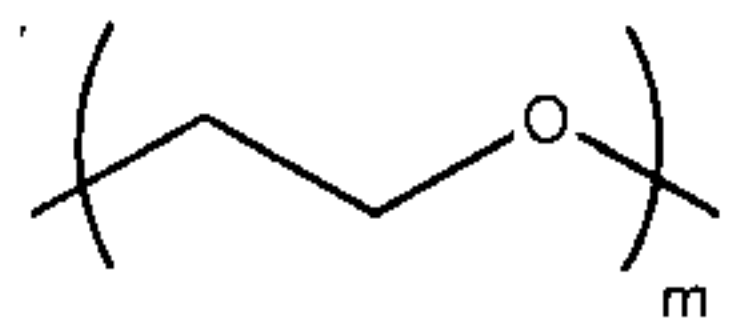
cyclodextrin and,  has a Mw between 0.2 to 5 kDa.

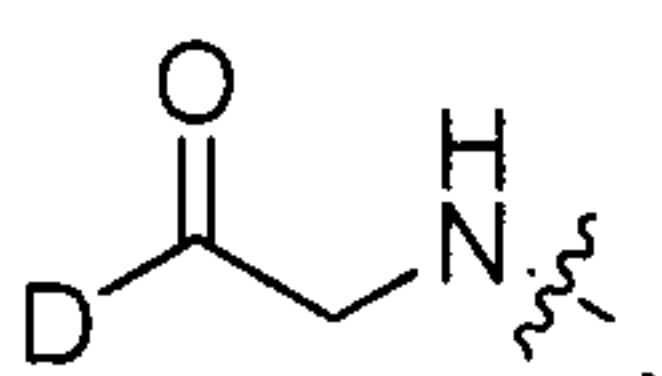
31. The polymer of claim 30, wherein each D-L- is .

32. The polymer of any one of claims 20 to 28, wherein the cyclodextrin comprises beta-cyclodextrin.

33. The polymer of any one of claims 1 to 32, wherein said therapeutic agent is a small molecule, a peptide, a protein or a polymer that has therapeutic activity.

34. The polymer of any one of claims 1 to 32, wherein the therapeutic agent is hydrophobic or  $\log P > 0.4$ .

35. The polymer of any one of claims 1 to 32, wherein the therapeutic agent has low aqueous solubility.

36. The polymer of any one of claims 1 to 32, wherein the therapeutic agent has an aqueous solubility of less than 5 mg/ml at physiological pH.

37. The polymer of any one of claims 1 to 36, wherein the therapeutic agent makes up at least 5% by weight of the polymer.

38. The polymer of any one of claims 1 to 36, wherein the therapeutic agent makes up at least 10% by weight of the polymer.
39. The polymer of any one of claims 1 to 36, wherein the therapeutic agent makes up at least 15% by weight of the polymer.
40. The polymer of any one of claims 1 to 39, wherein the therapeutic agent is selected from an anti-fungal, anti-bacterial, anti-mycotic, anti-viral, or anti-inflammatory agent.
41. The polymer of any one of claims 1 to 39, wherein the therapeutic agent is an anti-cancer therapeutic.
42. The polymer of any one of claims 1 to 39, wherein the therapeutic agent is an anti-neoplastic agent.
43. The polymer of any one of claims 1 to 39, wherein the therapeutic agent is an inhibitor of the S phase of the cell cycle.
44. The polymer of any one of claims 1 to 39, wherein the therapeutic agent is a topoisomerase I inhibitor.
45. The polymer of any one of claims 1 to 39, wherein the therapeutic agent is camptothecin.
46. The polymer of claim 45, wherein the camptothecin is covalently linked to the polymer via a glycine linker group.
47. The polymer of any one of claims 1 to 39, wherein the therapeutic agent is a camptothecin analog.



48. The polymer of any one of claims 1 to 39, wherein the therapeutic agent is topotecan.
49. The polymer of any one of claims 1 to 39, wherein the therapeutic agent is irinotecan.
50. The polymer of any one of claims 1 to 39, wherein the therapeutic agent is a taxane.
51. The polymer of claim 50, wherein the taxane is covalently linked to the polymer via a glycine linker group.
52. The polymer of any one of claims 1 to 39, wherein the therapeutic agent is TAXOL\*.
53. The polymer of any one of claims 1 to 39, wherein the therapeutic agent is doxorubicin.
54. The polymer of any one of claims 1 to 39, wherein the therapeutic agent is amphotericin.
55. The polymer of any one of claims 1 to 38, wherein therapeutic agent is selected from anorexics, antiarthritics, antiasthmatic agents, anticonvulsants, antidepressants, antihistamines, anti-nauseants, antipruritics, antipsychotics, antipyretics, antispasmodics, cardiovascular preparations, antihypertensives, diuretics, vasodilators, central nervous system stimulants, cough and cold preparations, decongestants, diagnostics, hormones, bone growth stimulants and bone resorption inhibitors, immunosuppressives, muscle relaxants, psychostimulants, sedatives, tranquilizers, anti-epileptics, anesthetics, hypnotics, neuroleptic agents, anxiolytics, neuron blocking agents, anticholinergic and cholinomimetic agents, antimuscarinic and muscarinic agents, antiadrenergics, and antiarrhythmics.

\*Trade-mark

56. The polymer of any one of claims 1 to 39, wherein the therapeutic agent is a receptor antagonist.

57. The polymer of claim 30, wherein the subunit is:

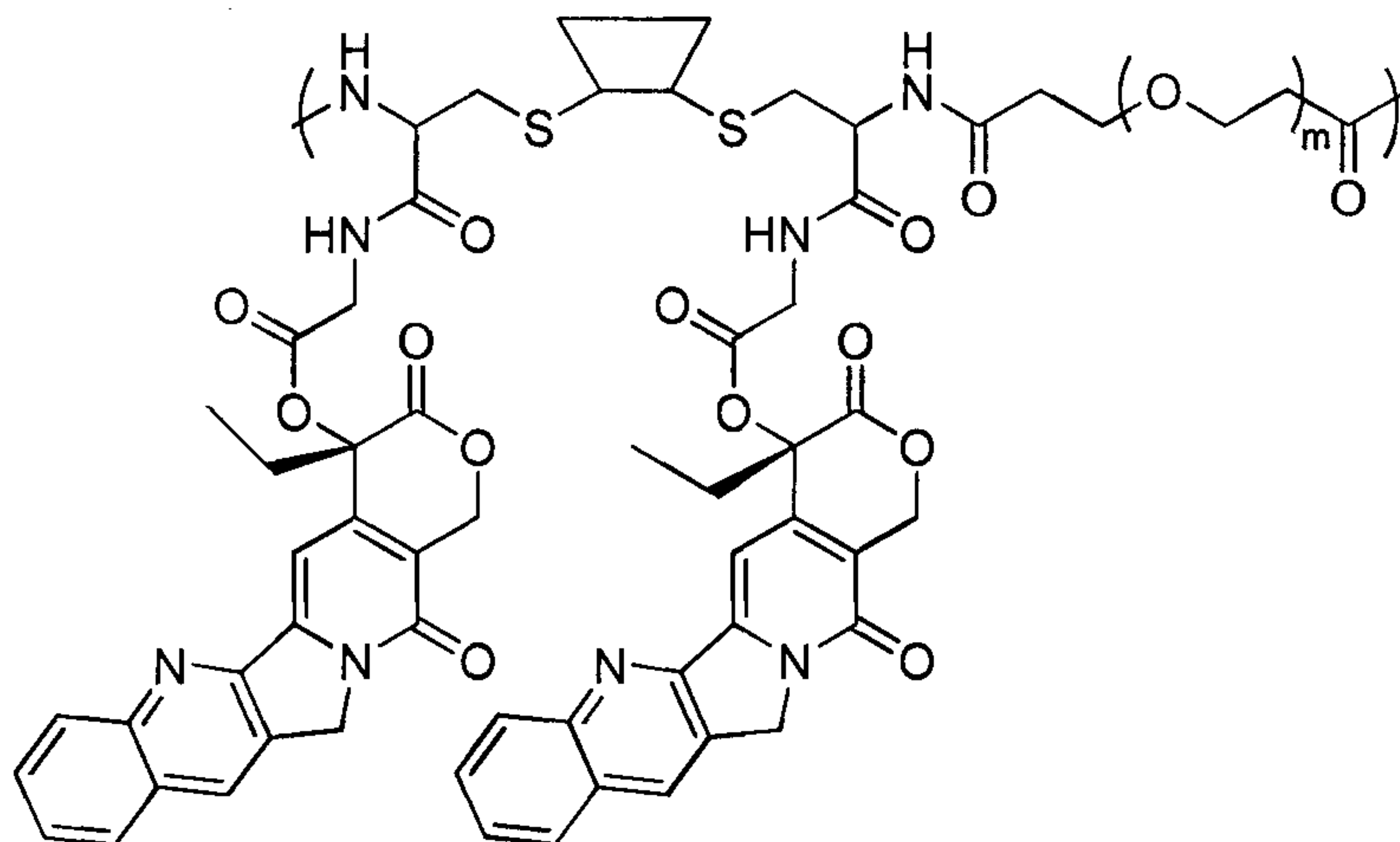

wherein  $\text{-(O-CH}_2\text{-CH}_2\text{)}_m$  has a Mw between 0.2 and 5 kDa.

58. The polymer of claim 57, wherein  $\text{-(O-CH}_2\text{-CH}_2\text{)}_m$  has a Mw of about 3.4 kDa.

59. The polymer of claim 57, wherein the polymer comprises a subunit having the formula:





65. The polymer of any one of claims 1 to 62, wherein the polymer has a molecular weight of 70,000-150,000 amu.
66. A pharmaceutical composition comprising a pharmaceutical excipient and a polymer of any one of claims 1 to 65, or a pharmaceutically acceptable ester, salt, or hydrate thereof.
67. The pharmaceutical composition of claim 66, comprising a sugar.
68. The pharmaceutical composition of claim 67, wherein the sugar is mannitol.
69. The pharmaceutical composition of claim 67, wherein the sugar is lactose.
70. The pharmaceutical composition of claim 67, wherein the sugar is glucose.
71. The pharmaceutical composition of claim 67, wherein the sugar is sucrose.
72. The pharmaceutical composition of claim 67, wherein the sugar is sorbitol.
73. A pharmaceutical dosage form comprising a therapeutically effective amount of one or more of the polymers or pharmaceutical compositions of any one of claims 1 to 72.
74. Use of a pharmaceutically effective amount of one or more of the polymers, pharmaceutical compositions, or pharmaceutical dosage forms of any one of claims 1 to 73 in the treatment of an animal.



75. A method of making the polymer of any one of claims 20 to 65 comprising:  
providing a water soluble linear polymer comprising cyclodextrin moieties and comonomers which do not contain cyclodextrin moieties (comonomers), wherein the cyclodextrin moieties and the comonomers alternate in the water soluble linear polymer and wherein the water soluble linear polymer comprises at least four cyclodextrin moieties and at least four comonomers; and  
covalently attaching therapeutic agents to the water soluble linear polymer, thereby making a water soluble linear polymer conjugate, wherein the therapeutic agents can be cleaved from the water soluble linear polymer conjugate under biological conditions to release therapeutic agents.
76. The method of claim 75, wherein each of the therapeutic agents is attached via a linker group.
77. The method of claim 75 or 76, wherein the polymer is made by a process comprising:  
providing cyclodextrin moiety precursors,  
providing comonomer precursors, and  
copolymerizing said cyclodextrin moiety precursors and comonomer precursors to thereby make the polymer.
78. The method of any one of claims 75 to 77, comprising providing cyclodextrin moiety precursors modified to bear one reactive site at each of exactly two positions, and reacting the cyclodextrin moiety precursors with comonomer precursors having exactly two reactive moieties capable of forming a covalent bond with the reactive sites under polymerization conditions that promote reaction of the reactive sites with the reactive moieties to form covalent bonds between the comonomers and the cyclodextrin moieties, whereby the polymer comprising alternating units of a cyclodextrin moiety and a comonomer is produced.

79. The method of claim 77 or 78, wherein each of the comonomer precursors is a compound containing at least two functional groups through which reaction and thus linkage of the cyclodextrin moieties is achieved.

80. The method of claim 79, wherein the functional groups, which may be the same or different, terminal or internal, of each of the comonomer precursors comprise an amino acid, imidazole, hydroxyl, thio, acyl halide,  $\text{-HC=CH-}$ ,  $\text{-C}\equiv\text{C-}$  group, or derivative thereof.

81. The method of any one of claims 75 to 80, wherein each of the comonomers comprises a polyethylene glycol, each of the cyclodextrin moieties comprises a beta-cyclodextrin, and each of the therapeutic agents comprises camptothecin.

82. The method of any one of claims 75 to 80, wherein each of the linker groups comprises glycine, each of the comonomers comprises a polyethylene glycol, each of the cyclodextrin moieties comprises a beta-cyclodextrin, and each of the therapeutic agents comprises camptothecin.



FIG. 1

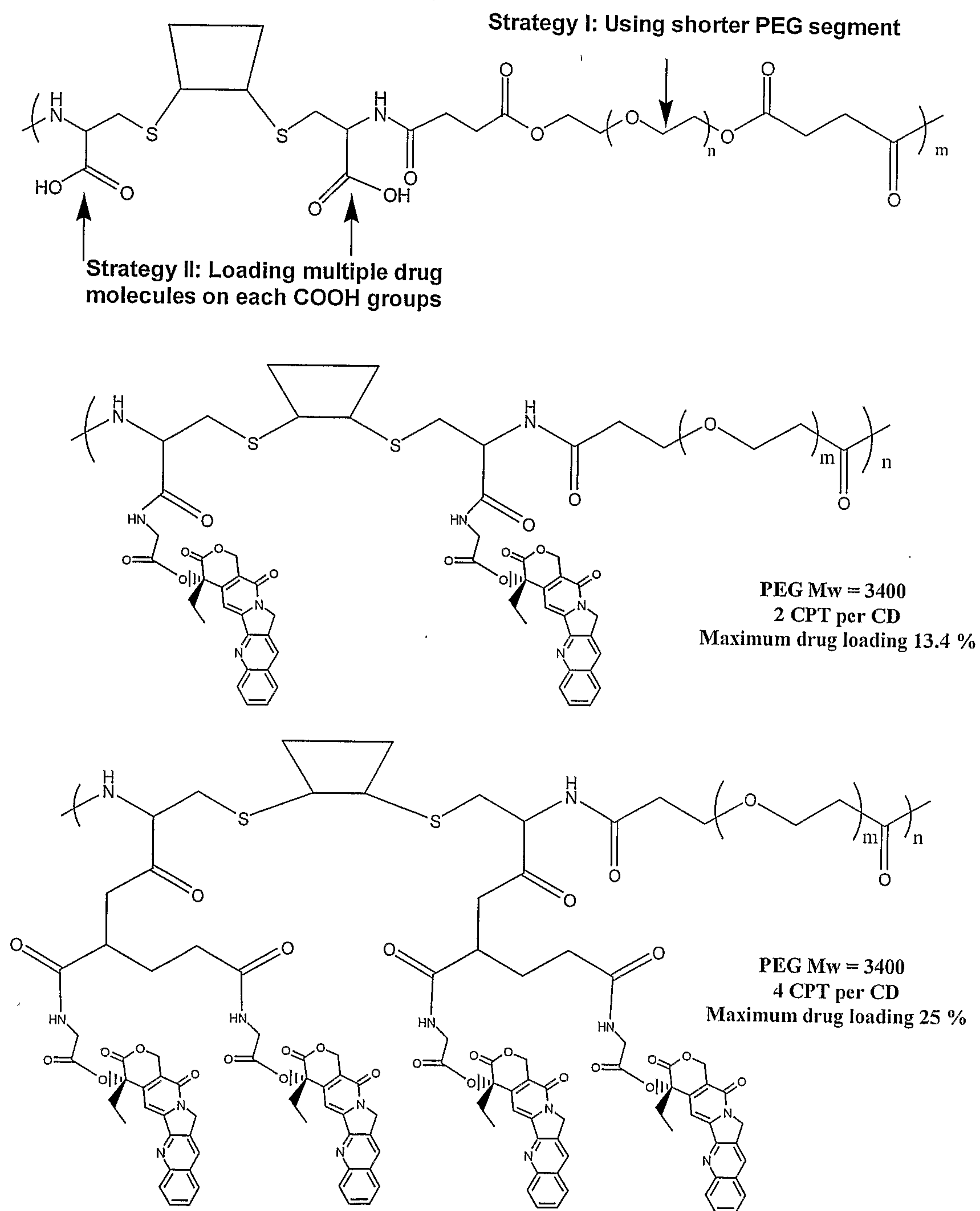
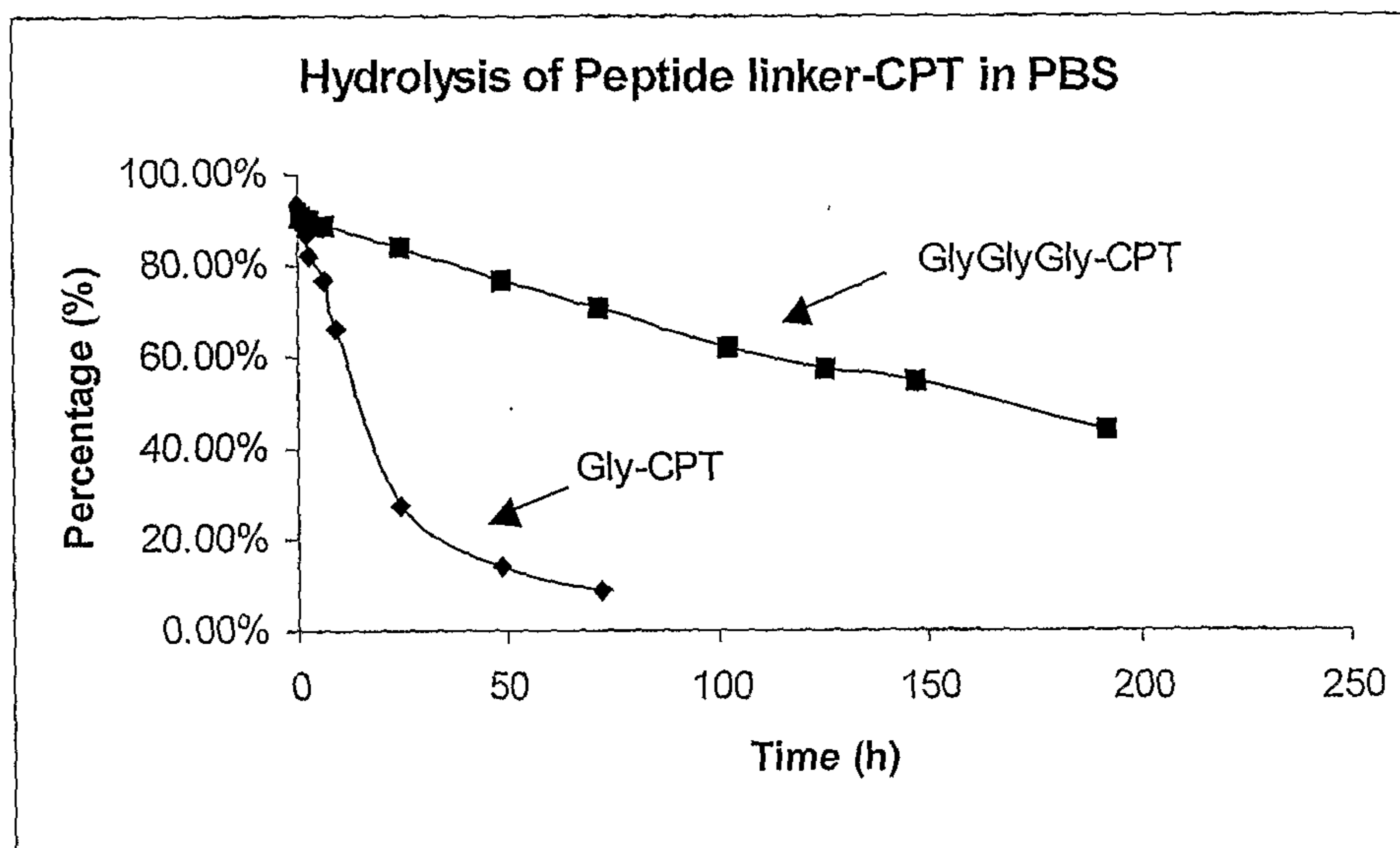

FIG. 2





**FIG. 3: Lactone Ring Stability of CPT, 11 and 12 in PBS (pH 7.4)**

FIG. 4



**FIG. 5a:** Polymerization control by adjusting polymerization time.**FIG. 5b:** Polymerization control by adjusting polymerization time.

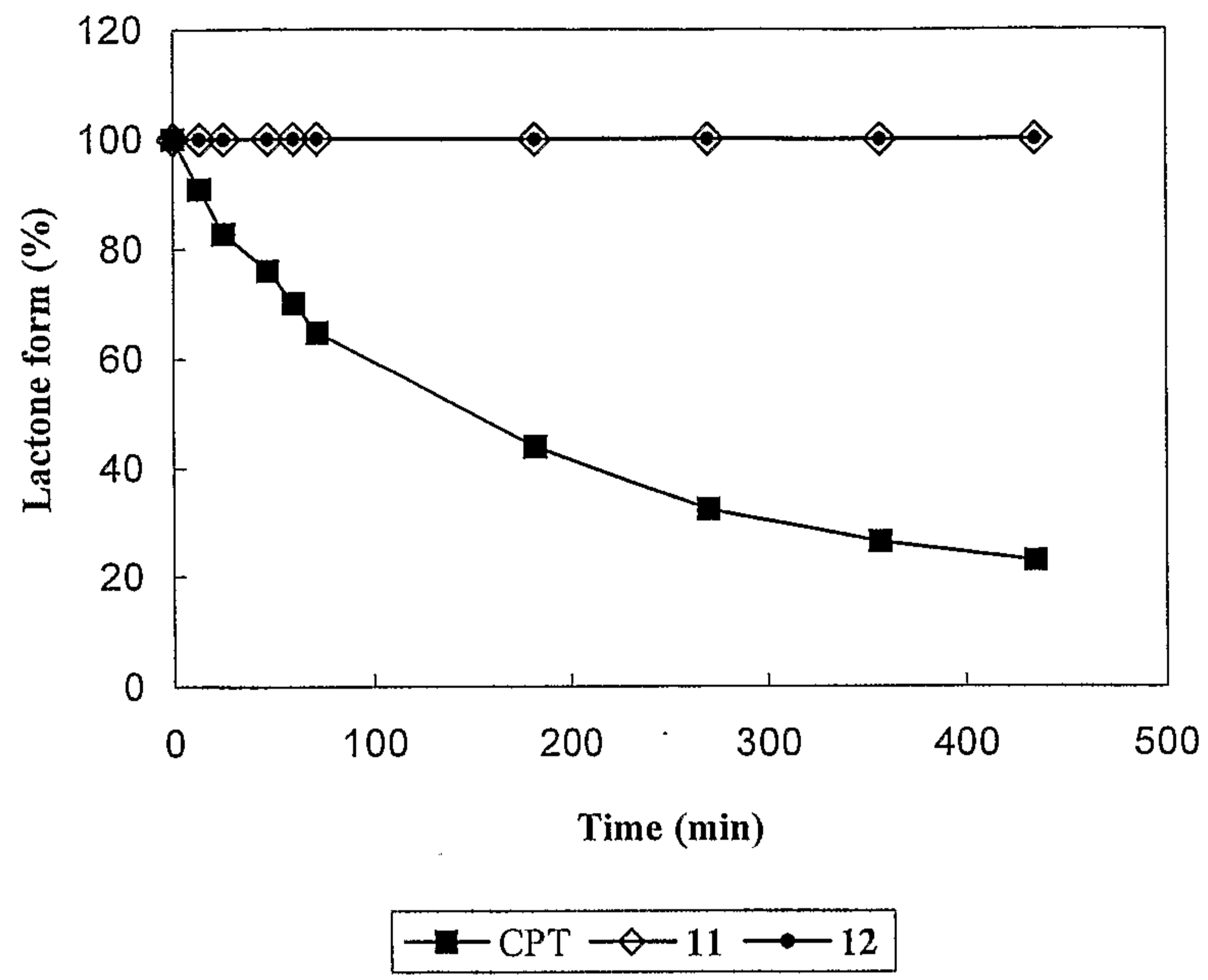
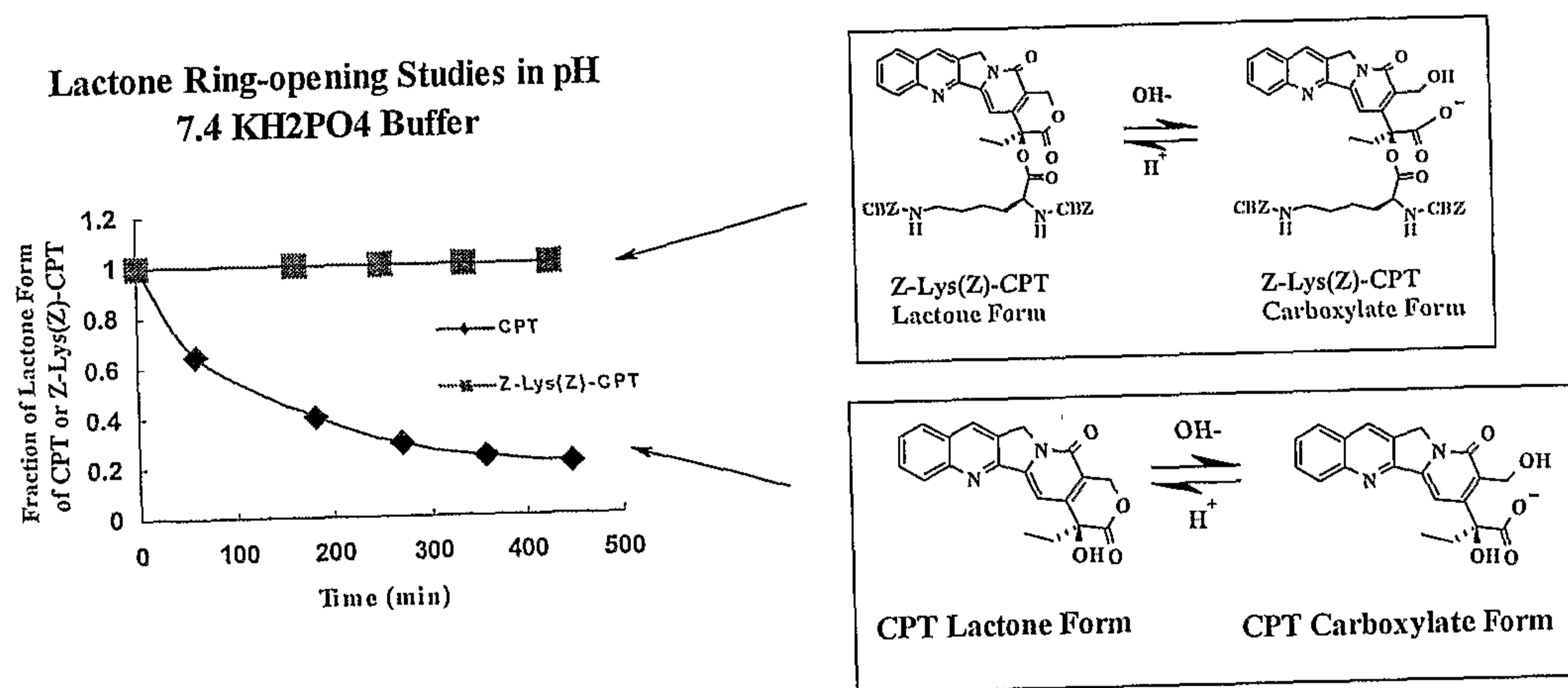
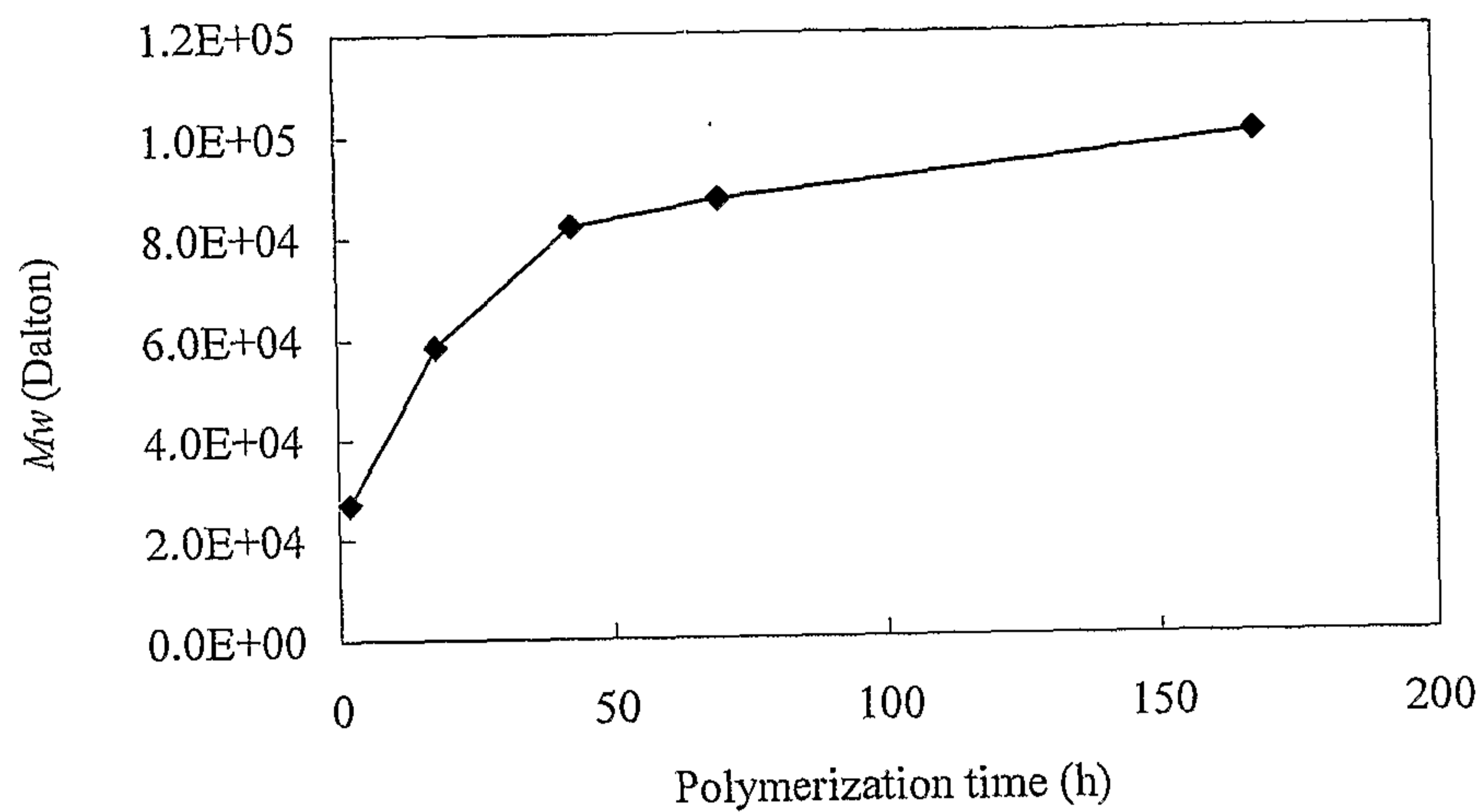
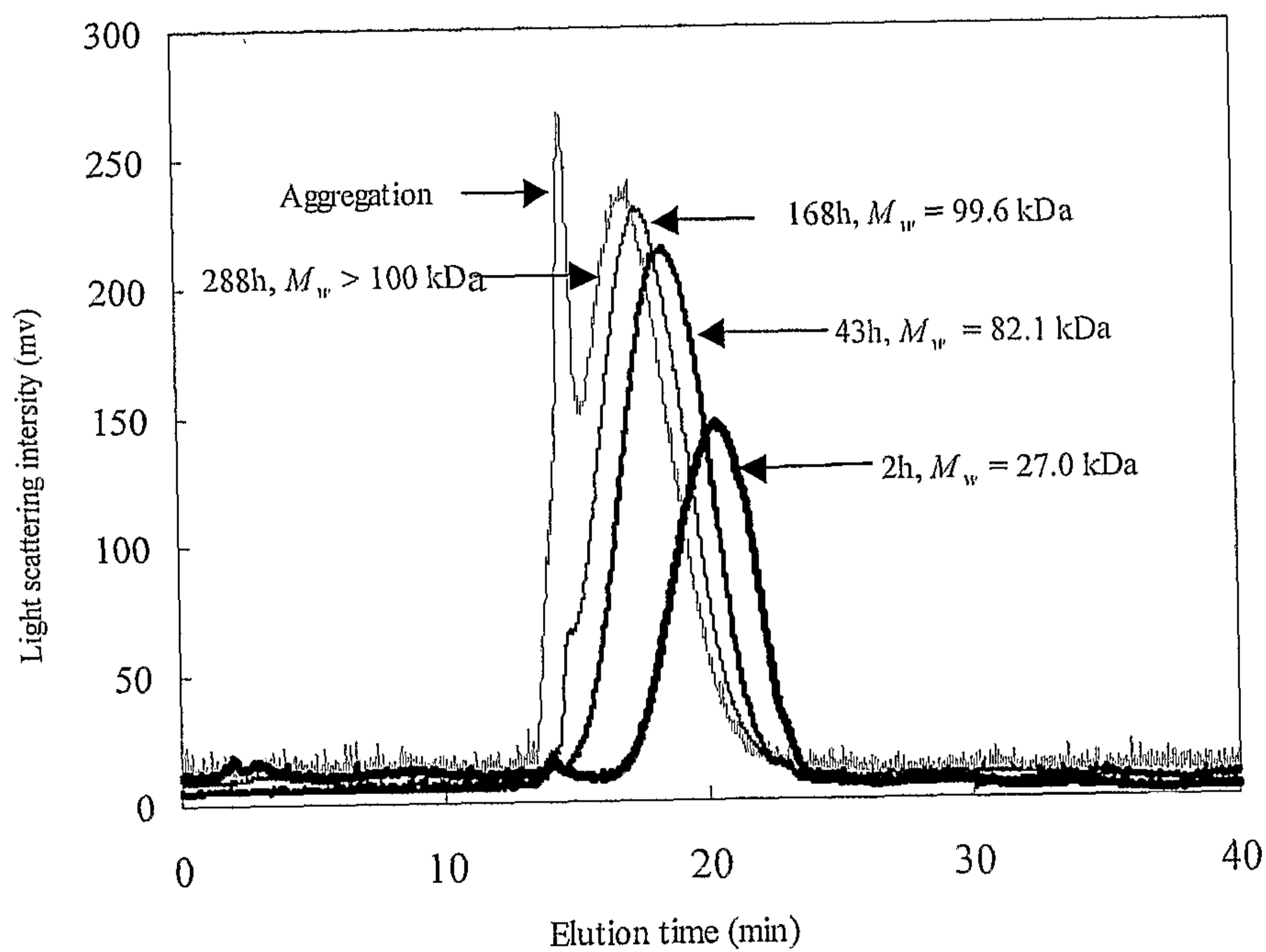

**FIG. 6:** CPT release from **HG6** and **HGGG6** at 37 °C after 24 h in buffer solutions with pHs ranging from 1.1 to 13.1

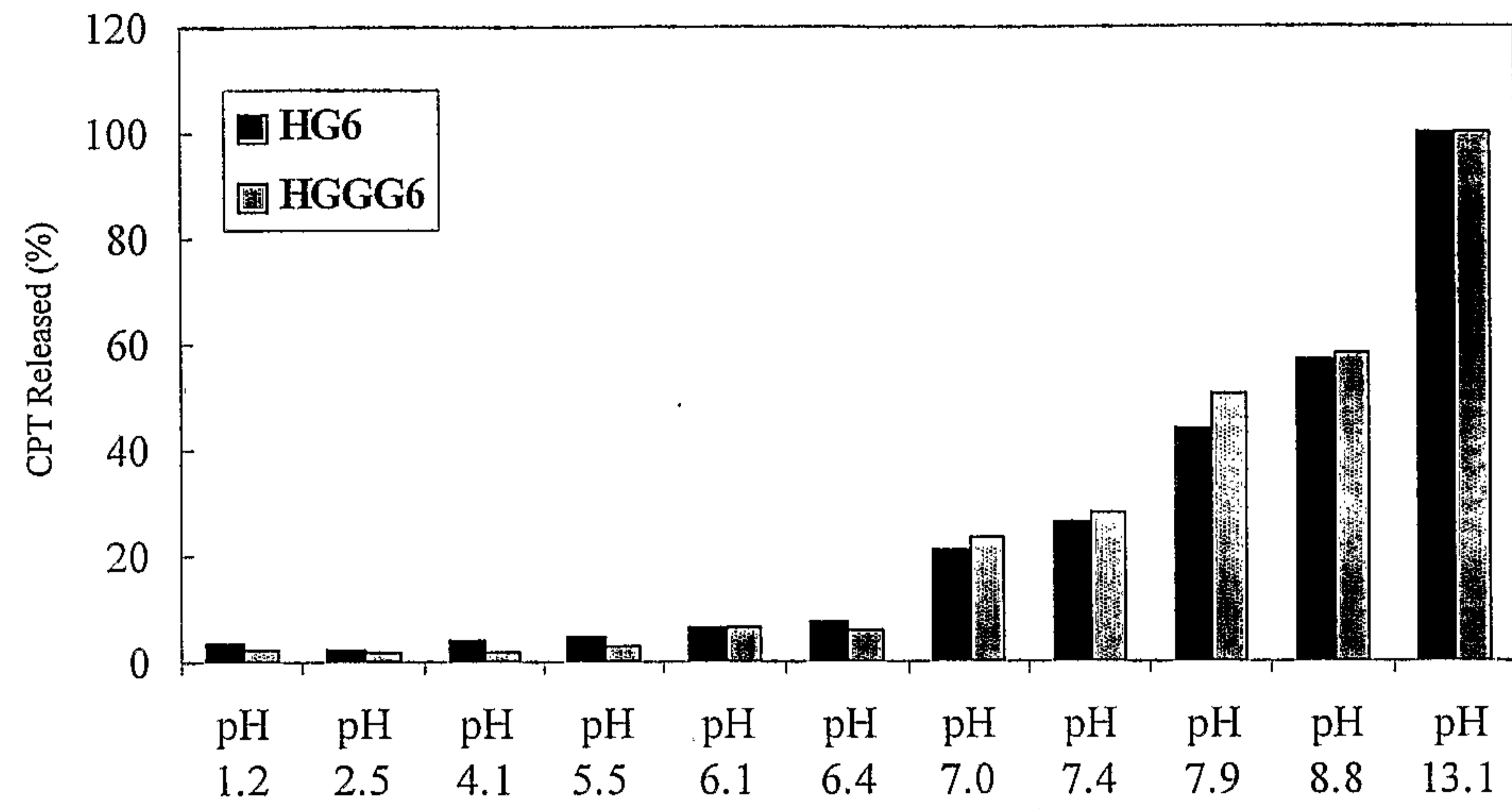
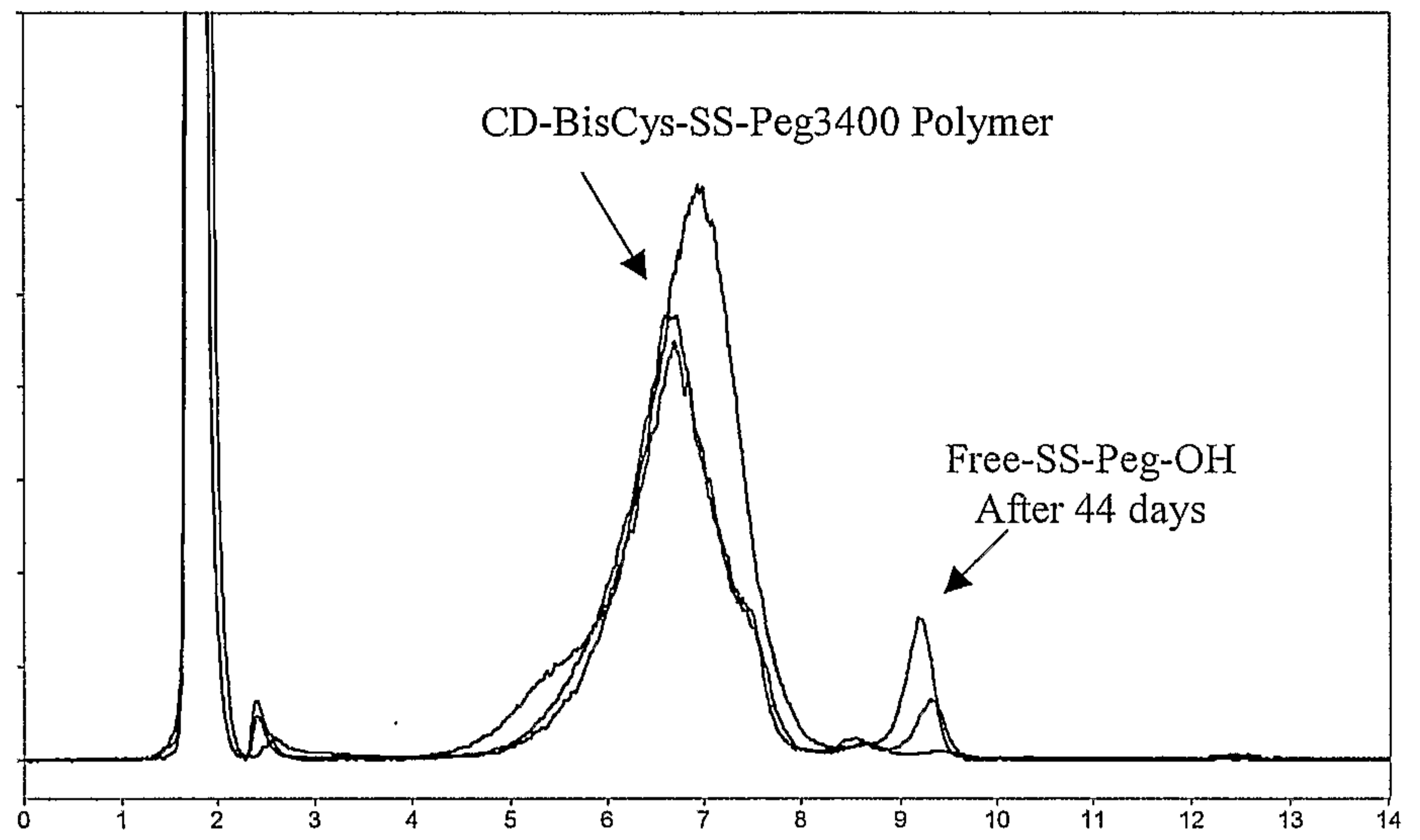

FIG. 7: HPLC analysis of degradation of CD-BisCys-SS-Peg3400 Polymer



**FIG. 8:** The tumor growth curve as a function of time for the D5W, CPT, irinotecan, LGGG10 at its highest non-toxic dose tested (18 mg CPT/kg), and the other three conjugates with high MW polymer (HGGG6, HG6, HGGG10) at their MTDs.

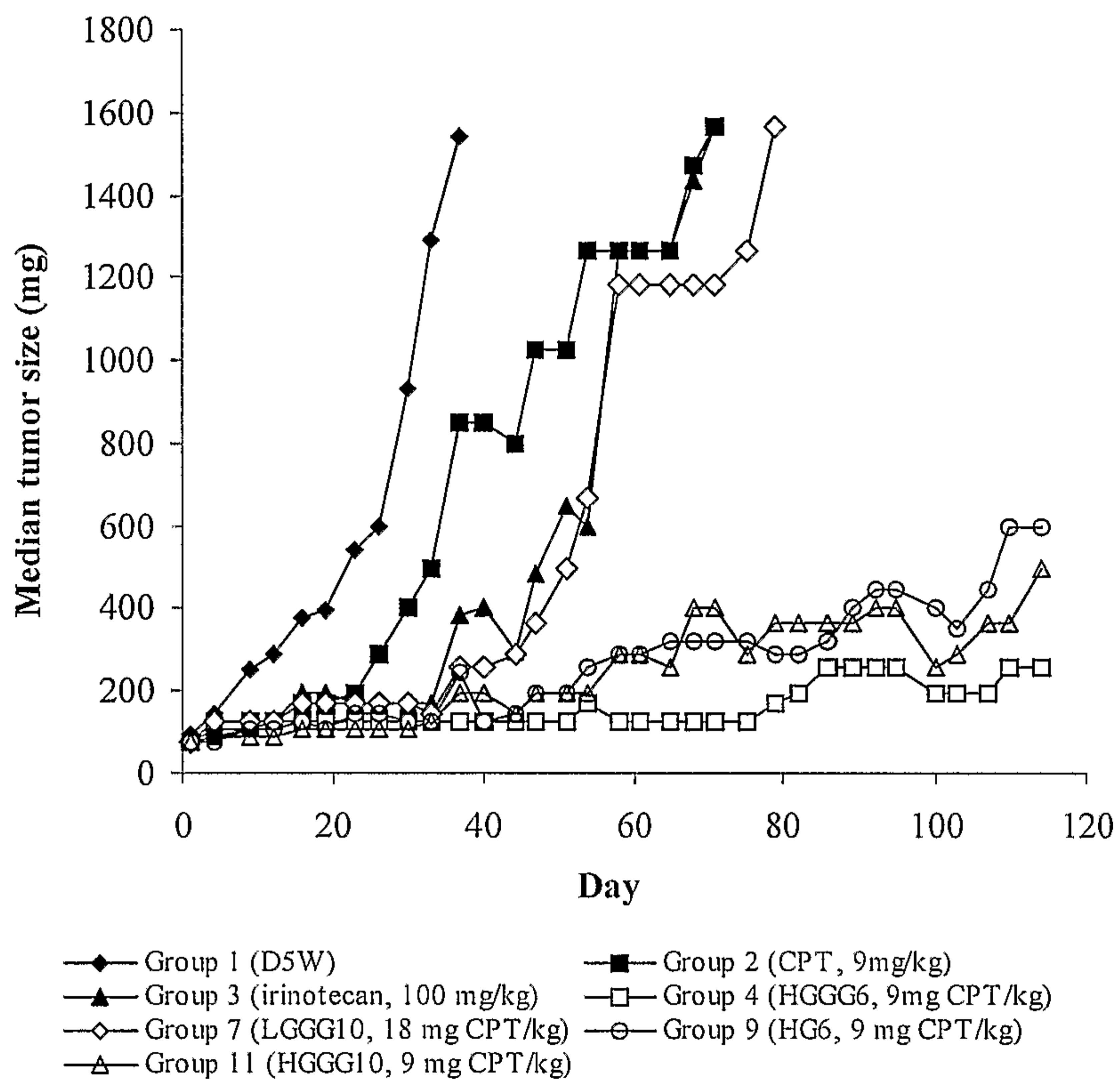
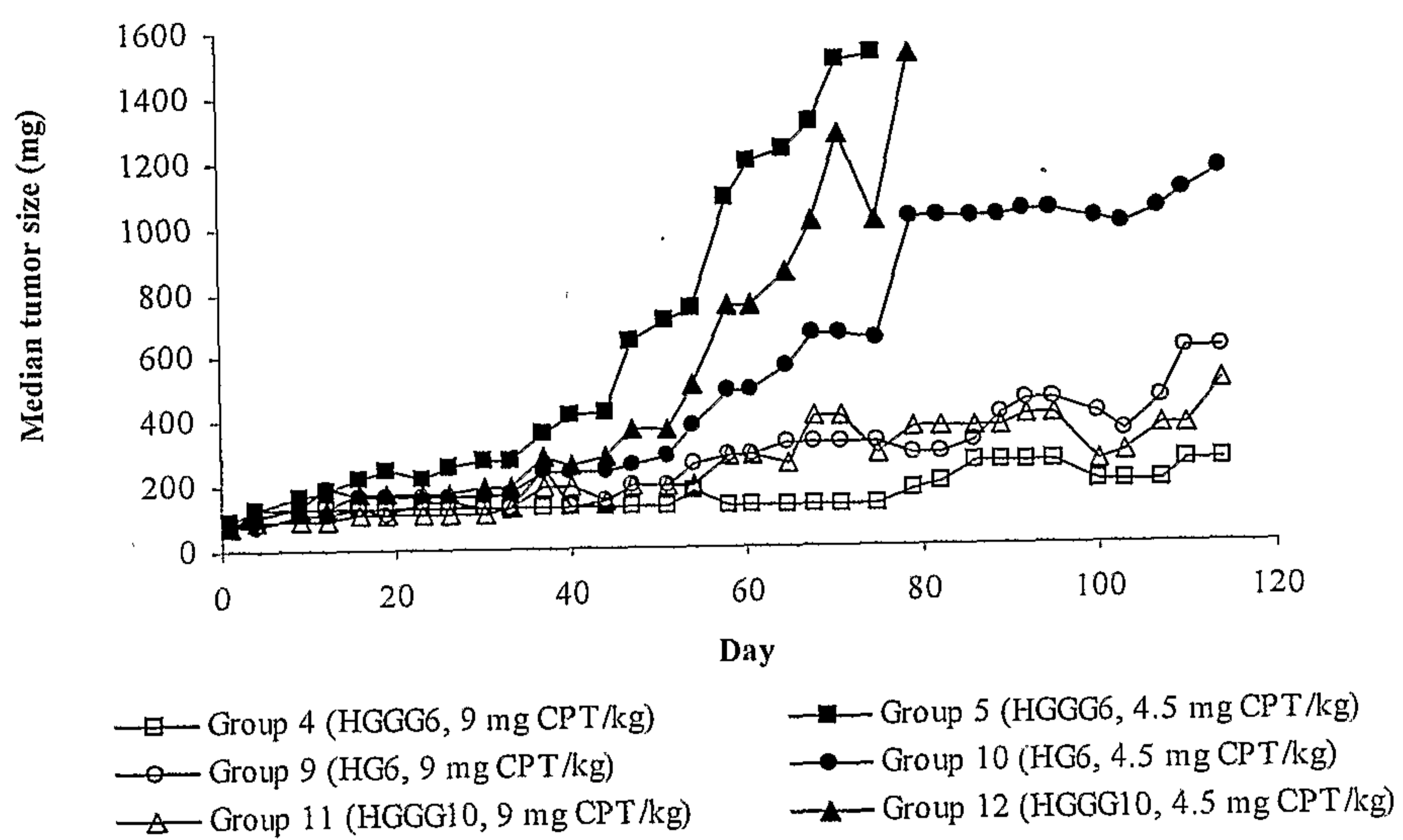
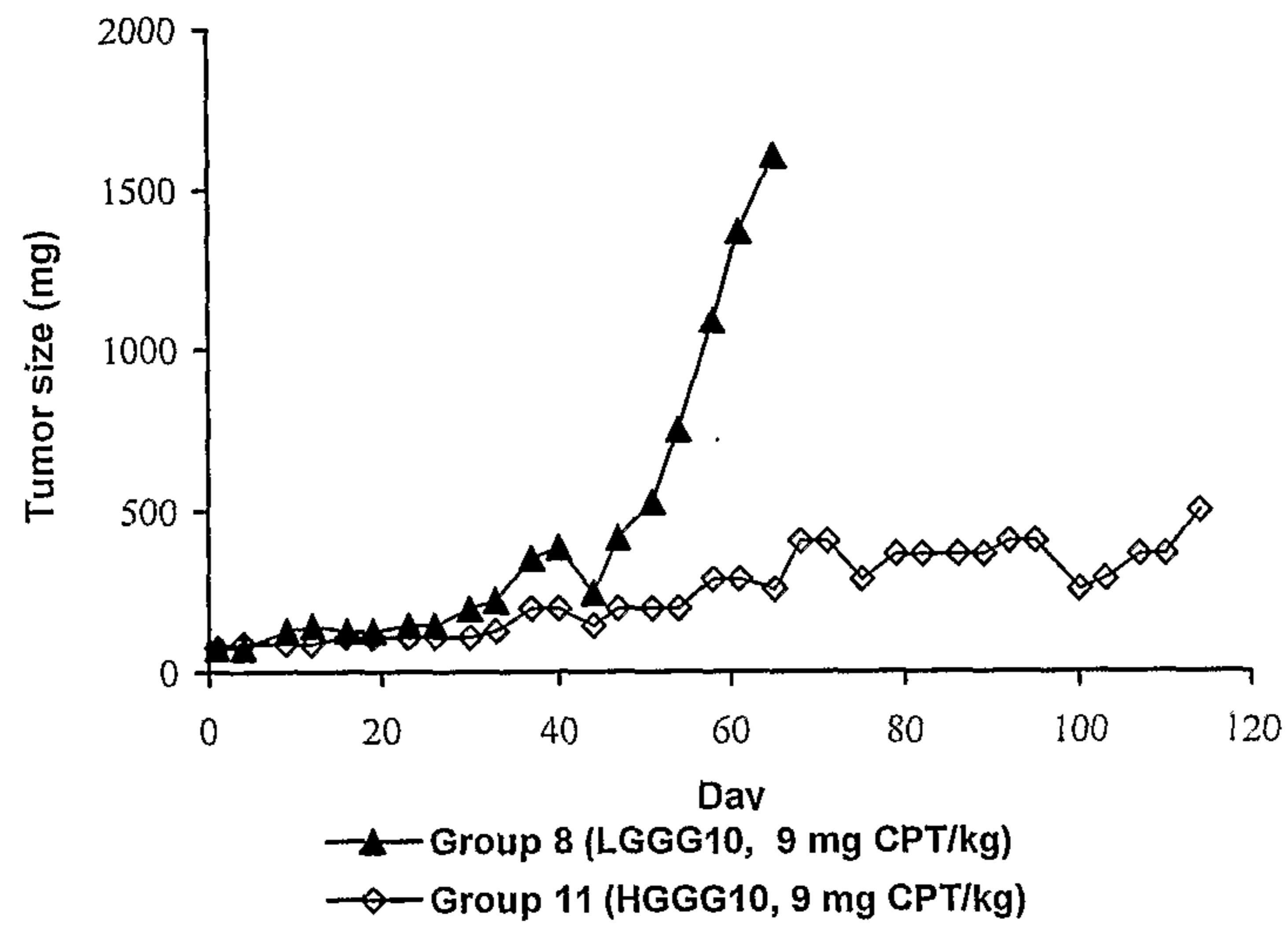



FIG. 9. The median tumor growth curves for HGGG6, HG6 and HGGG10



**FIG. 10:** The medium tumor growth curves for LGGG10 and HGGG10 each dosed at 9 mg CPT/kg



**FIG. 11:** Mean body weight (MBW) losses as a function of time plotted for D5W, CPT, irinotecan and the three conjugates containing high MW polymer at their MTDs

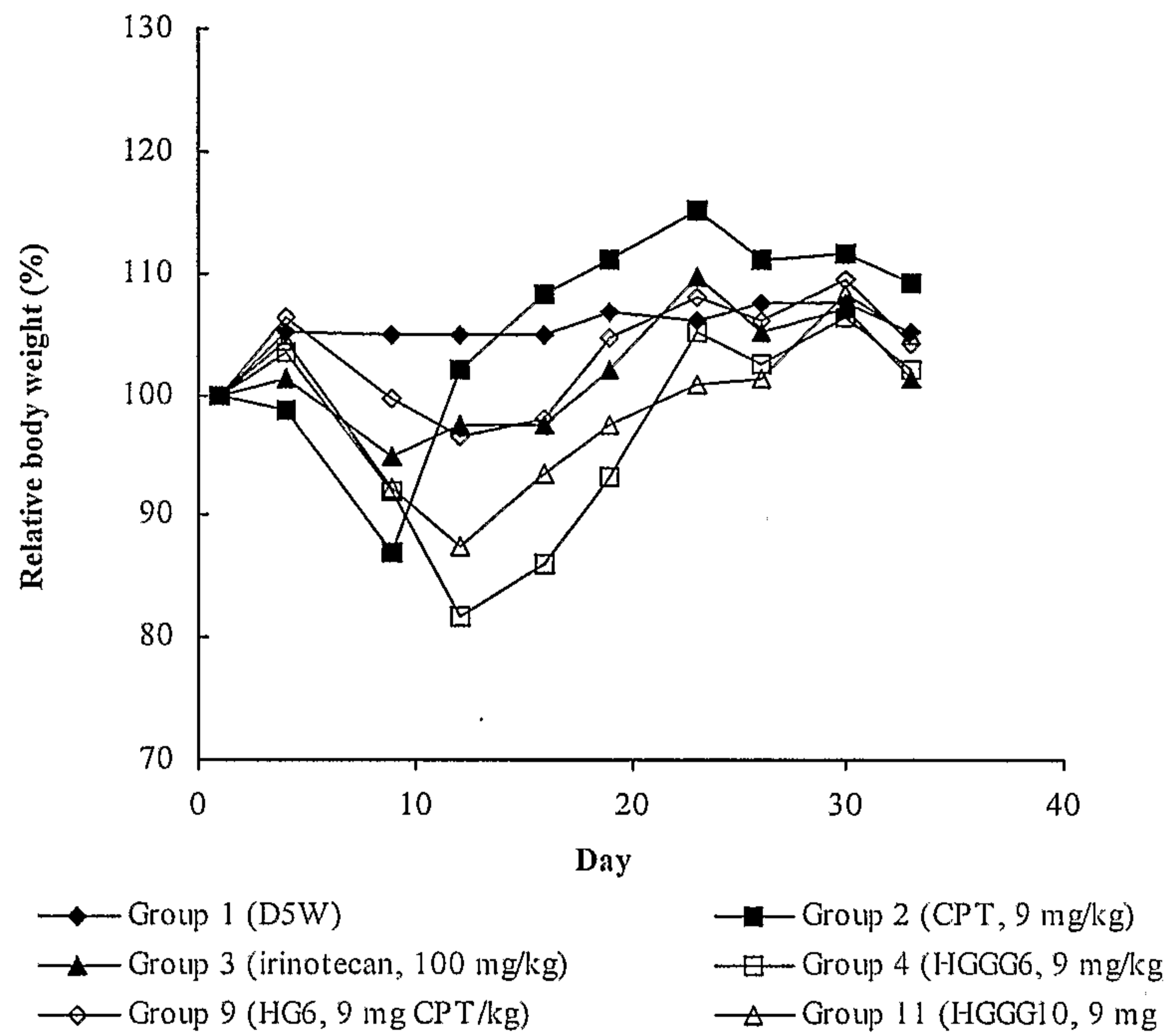



**FIG. 12.** The correlation of CPT concentration (ng/mg tissue) to tumor size (in mg)