



US00D672284S

(12) **United States Design Patent**  
**Perini**

(10) **Patent No.:** **US D672,284 S**

(45) **Date of Patent:** **\*\* Dec. 11, 2012**

(54) **AUTOMOBILE**

(75) Inventor: **Filippo Perini**, Piacenza (IT)

(73) Assignee: **Automobili Lamborghini S.p.A.**,  
Sant'Agata Bolognese (IT)

(\*\*) Term: **14 Years**

(21) Appl. No.: **29/400,653**

(22) Filed: **Aug. 31, 2011**

(30) **Foreign Application Priority Data**

Mar. 2, 2011 (EM) ..... 001829441-0001

(51) **LOC (9) Cl.** ..... **12-08**

(52) **U.S. Cl.** ..... **D12/92**

(58) **Field of Classification Search** ..... D12/86,  
D12/90-92, 88; D21/424, 433, 434; 296/181.1,  
296/181.5

See application file for complete search history.

(56) **References Cited**

**U.S. PATENT DOCUMENTS**

D500,263 S	12/2004	Donckerwolke	
D528,945 S *	9/2006	Petrotta	D12/92
D582,315 S	12/2008	Fitzgerald	
D597,446 S *	8/2009	Ikeda et al.	D12/91
D604,670 S *	11/2009	Nagura et al.	D12/91
D617,683 S *	6/2010	Beneggi	D12/92
D619,500 S *	7/2010	Hsu et al.	D12/91
D629,720 S *	12/2010	Manzoni	D12/92
D630,554 S *	1/2011	Kim	D12/91
D631,796 S *	2/2011	Castriota	D12/92

D633,823 S *	3/2011	Matei et al.	D12/91
D647,004 S *	10/2011	Nemoto	D12/91
D657,715 S *	4/2012	Hakamata et al.	D12/91
D666,945 S *	9/2012	Ogawa et al.	D12/91

\* cited by examiner

*Primary Examiner* — Melody N Brown

(74) *Attorney, Agent, or Firm* — Blank Rome LLP

(57) **CLAIM**

The ornamental design for an automobile, as shown and described.

**DESCRIPTION**

FIG. 1 is a front perspective view of an automobile in accordance with the present design;

FIG. 2 is a rear perspective view of the automobile in accordance with the present design;

FIG. 3 is a front view of the automobile in accordance with the present design;

FIG. 4 is a rear view of the automobile in accordance with the present design;

FIG. 5 is a top plan view of the automobile in accordance with the present design;

FIG. 6 is a right side view of the automobile in accordance with the present design; and,

FIG. 7 is a left side view of the automobile in accordance with the present design.

The wheels shown in broken lines throughout the drawing are for illustrative purposes only and form no part of the claimed design.

**1 Claim, 7 Drawing Sheets**

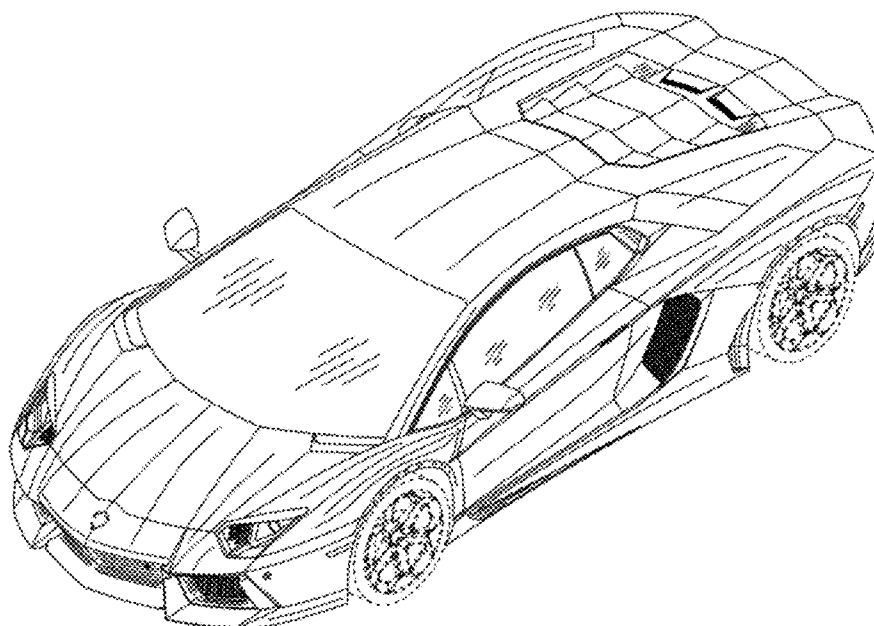

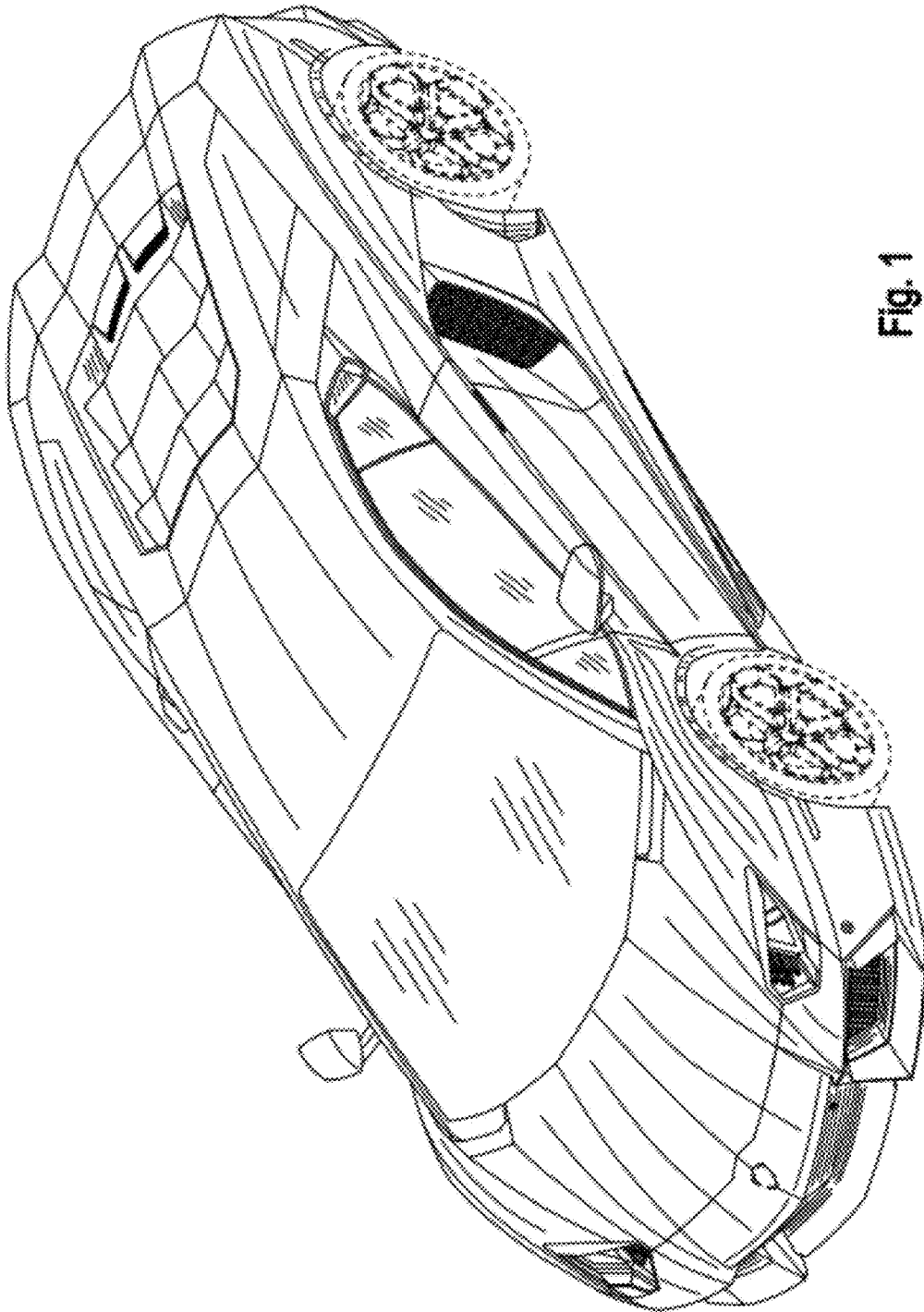

Fig. 1

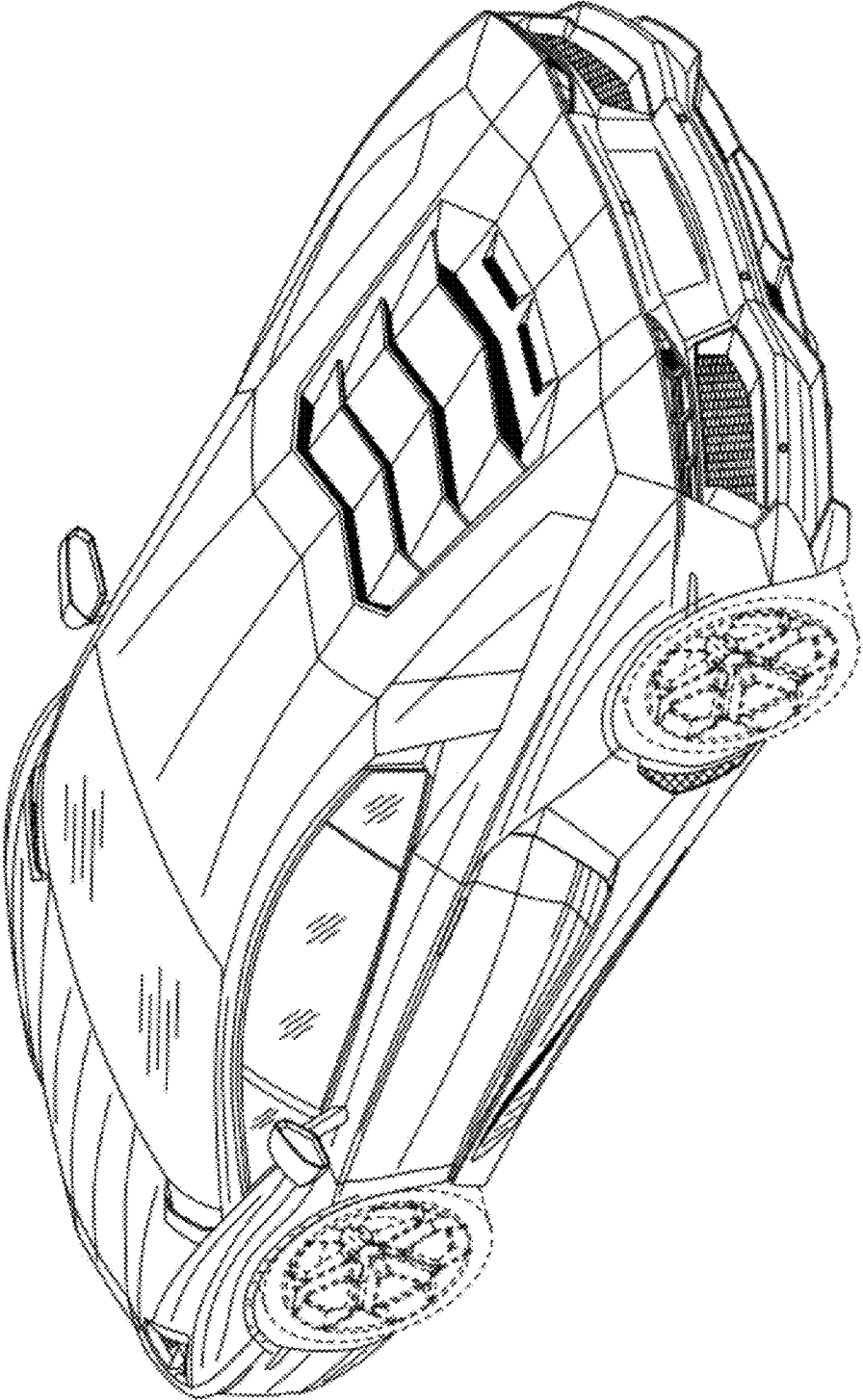

Fig. 2

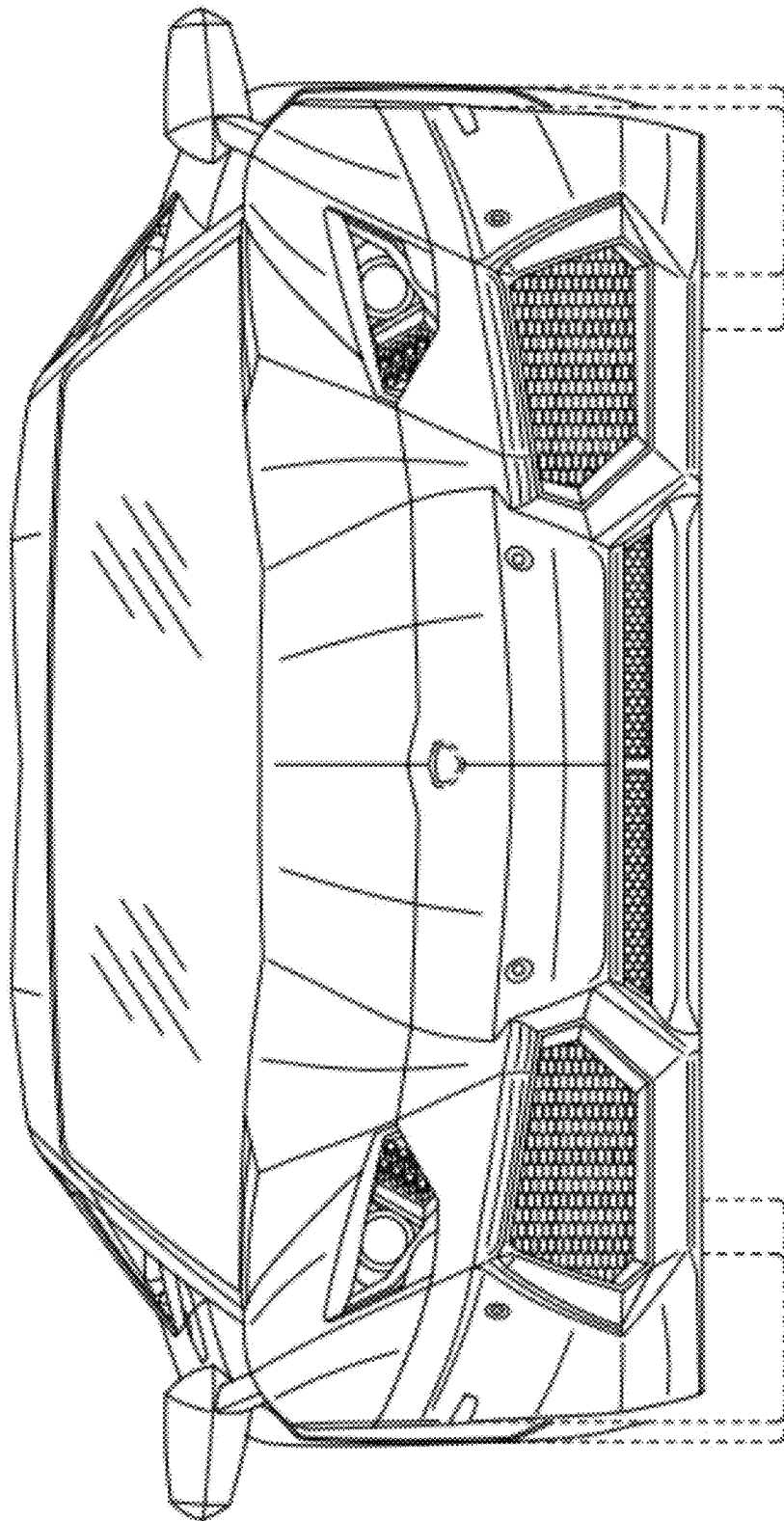

Fig. 3

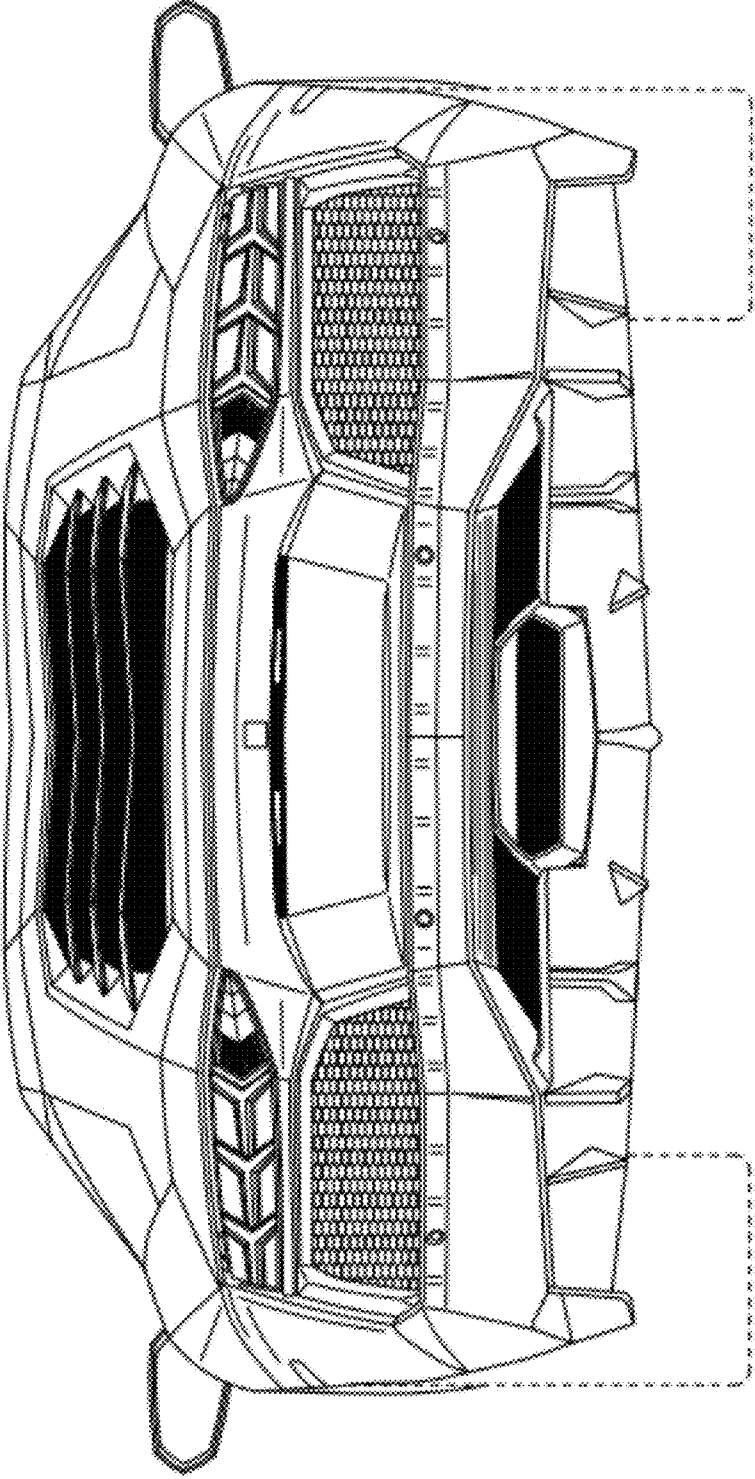

Fig. 4

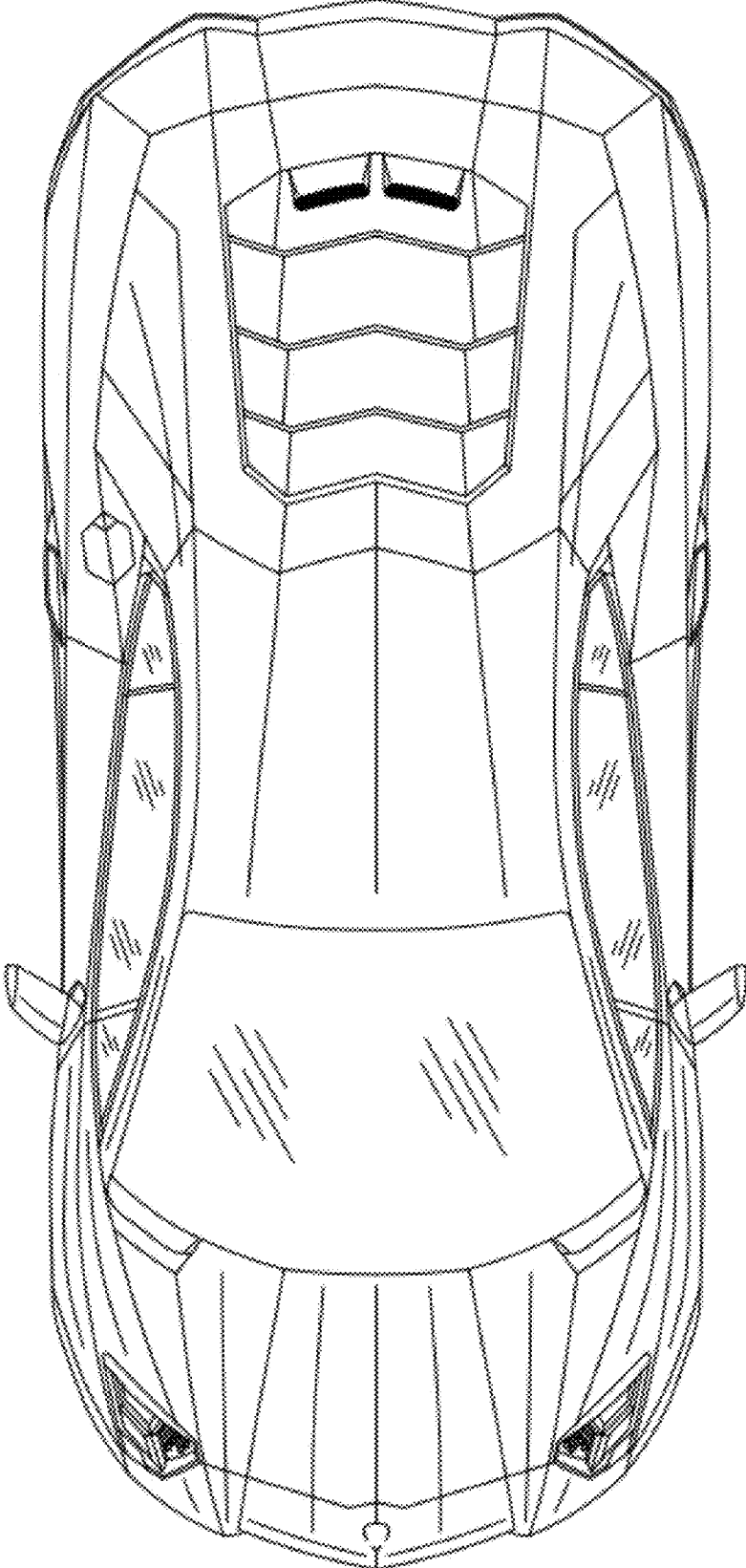

Fig. 5

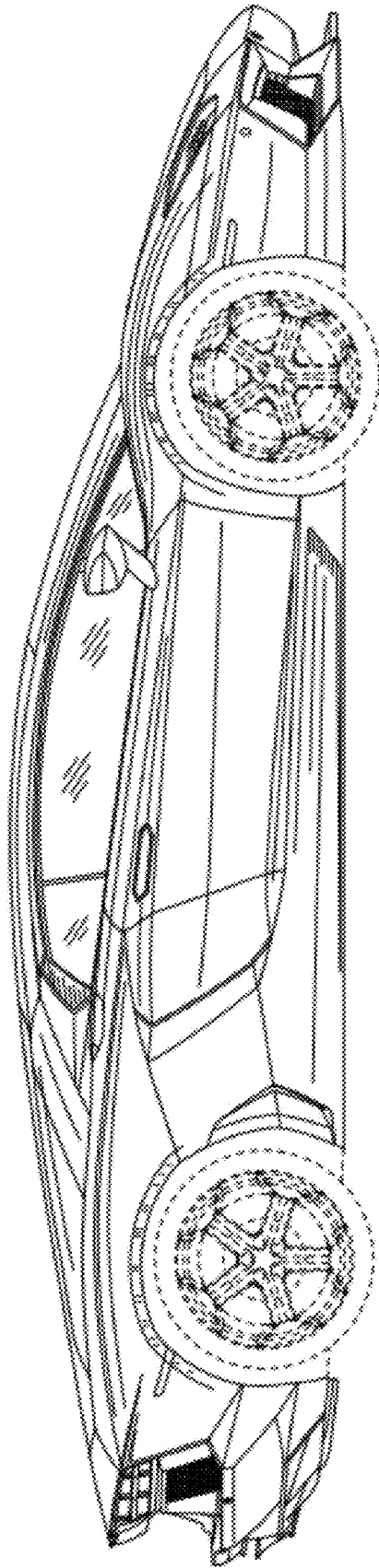

Fig. 6

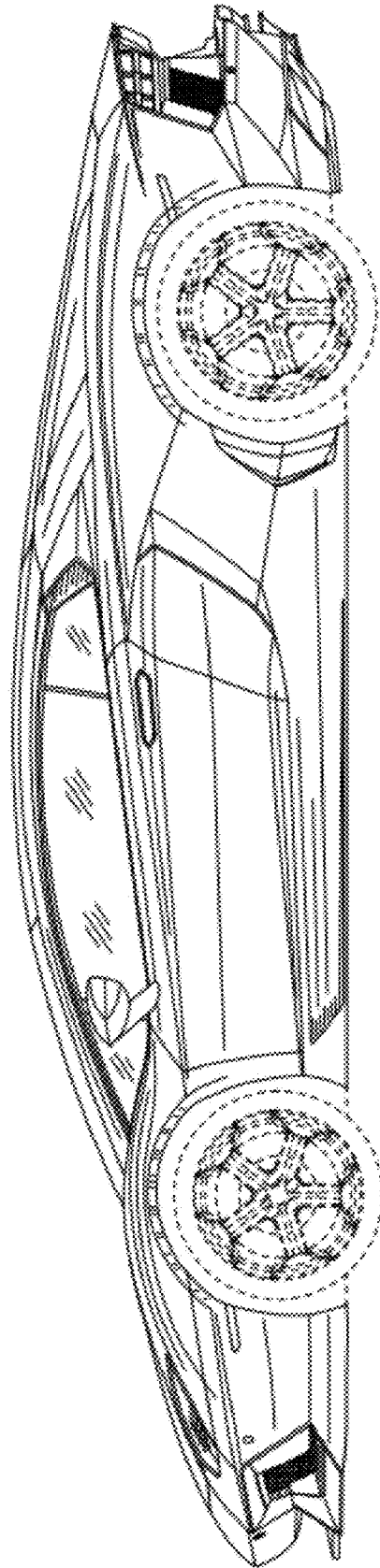

Fig. 7