



US 20120330409A1

(19) **United States**
(12) **Patent Application Publication**
Haug et al.

(10) **Pub. No.: US 2012/0330409 A1**
(43) **Pub. Date: Dec. 27, 2012**

(54) **METHODS AND APPARATUS FOR ENDOVASCULARLY REPLACING A PATIENT'S HEART VALVE**

tinuation of application No. 10/893,143, filed on Jul. 15, 2004, now Pat. No. 7,329,279, which is a continuation-in-part of application No. 10/746,280, filed on Dec. 23, 2003.

(75) Inventors: **Ulrich R. Haug**, Campbell, CA (US);
Hans F. Valencia, Berkeley, CA (US);
Robert A. Geshliger, San Francisco, CA (US);
Tom Saul, El Granada, CA (US);
Amr Salahieh, Saratoga, CA (US);
Dwight P. Morejohn, Davis, CA (US)

Publication Classification

(51) **Int. Cl.**
A61F 2/24 (2006.01)
(52) **U.S. Cl.** **623/2.19**

(73) Assignee: **SADRA MEDICAL, INC.**, Los Gatos, CA (US)

(57) **ABSTRACT**

(21) Appl. No.: **13/591,680**

Methods for endovascularly replacing a patient's heart valve. In some embodiments, the method includes the steps of endovascularly delivering a replacement valve and an anchor to a vicinity of the heart valve, the anchor having a braid, and expanding the braid to a deployed configuration against the patient's tissue. The braid may be fabricated from a single strand of wire and/or may comprise at least one turn feature.

(22) Filed: **Aug. 22, 2012**

Related U.S. Application Data

(63) Continuation of application No. 12/028,452, filed on Feb. 8, 2008, now Pat. No. 8,252,052, which is a con-

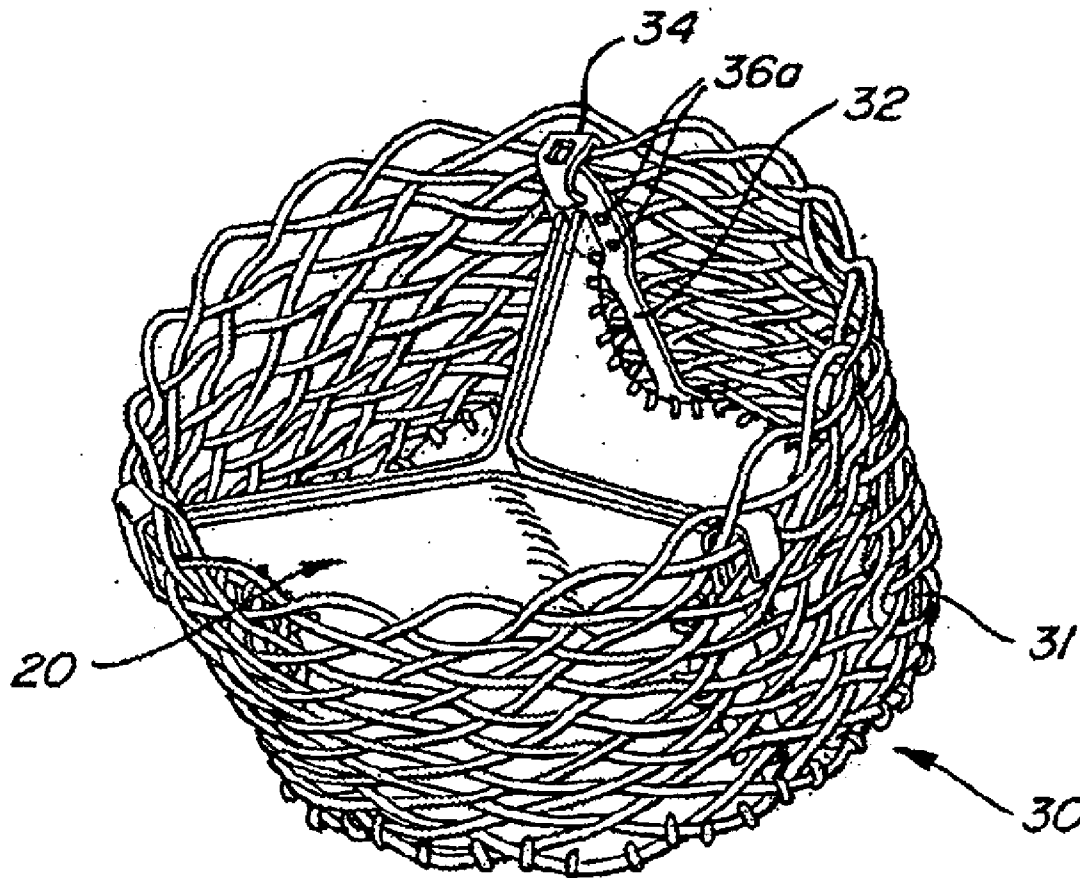

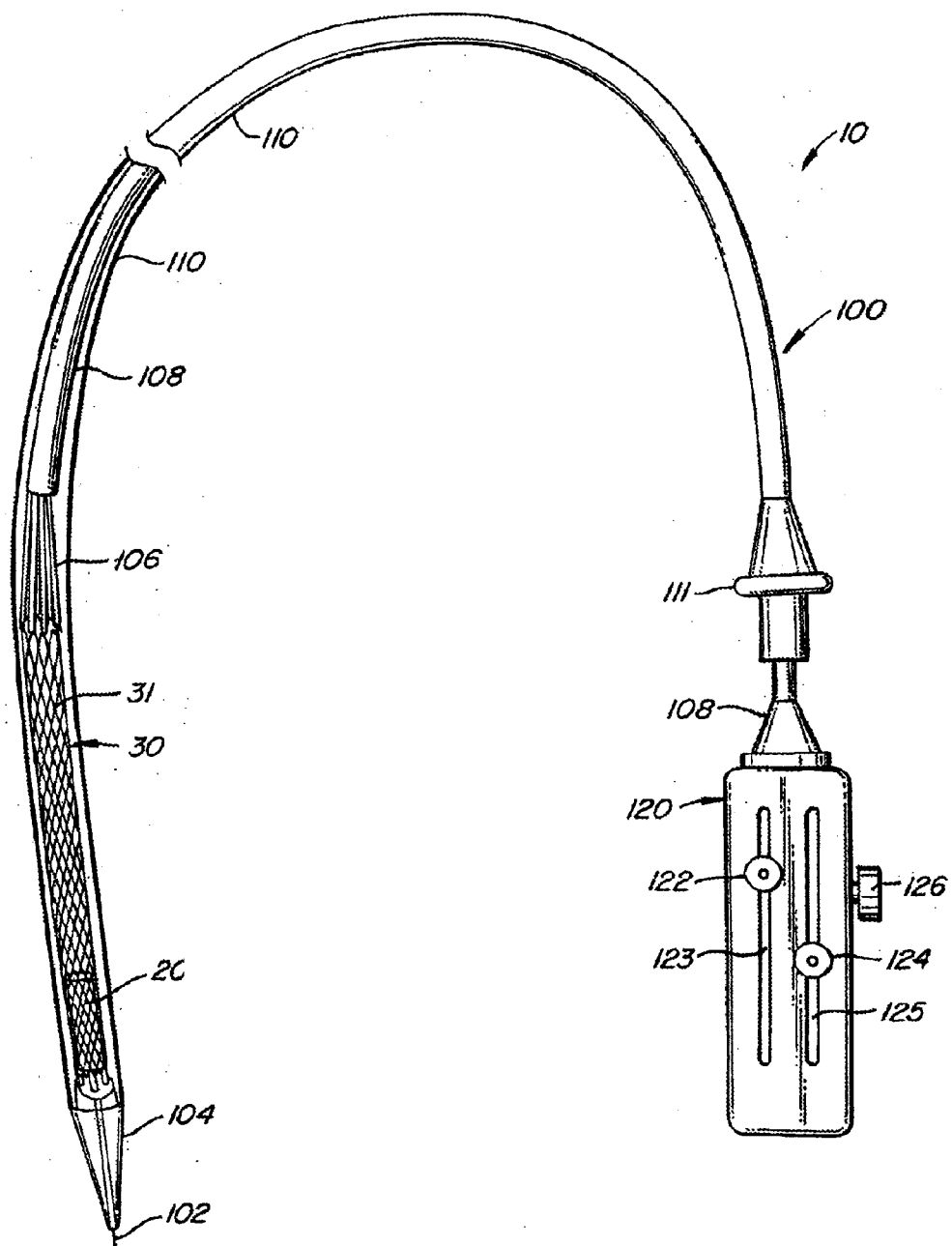
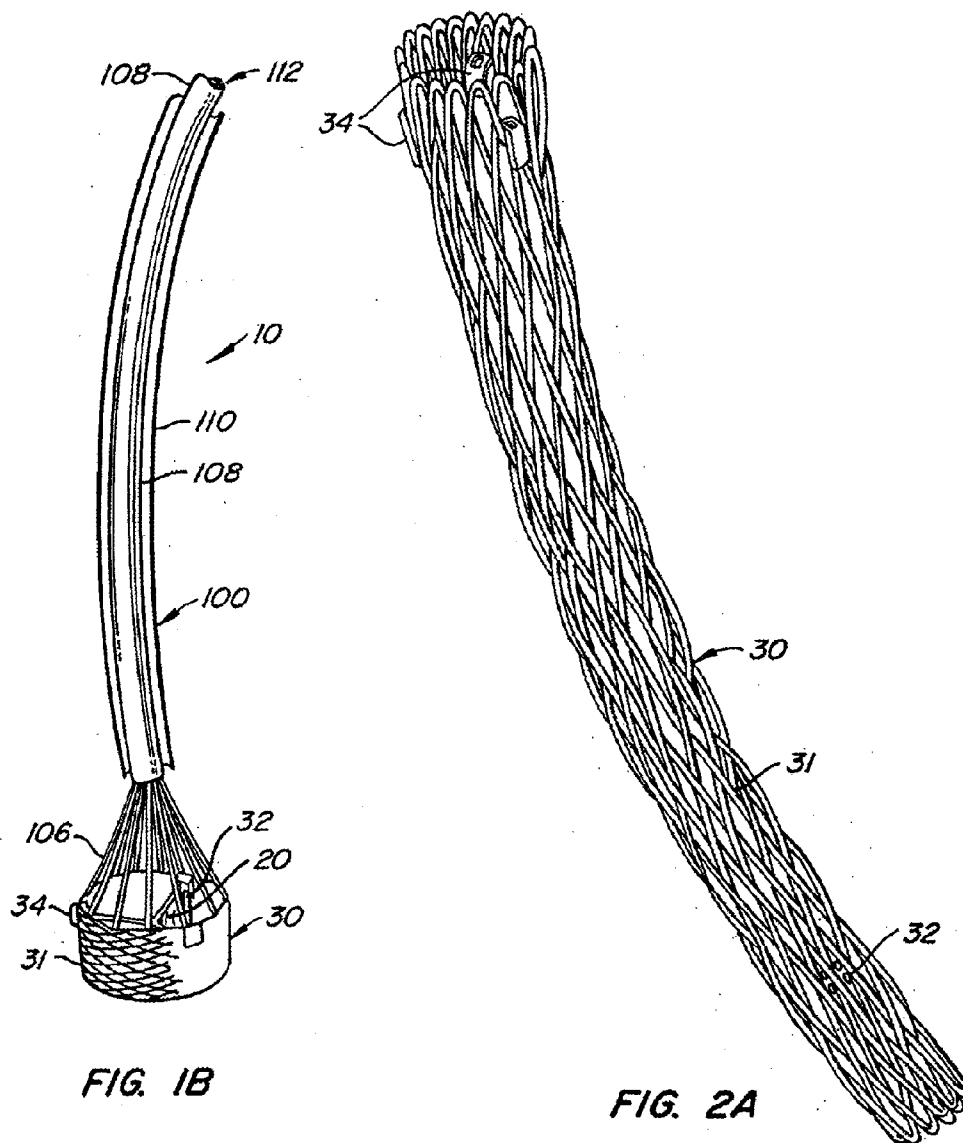

FIG. 1A



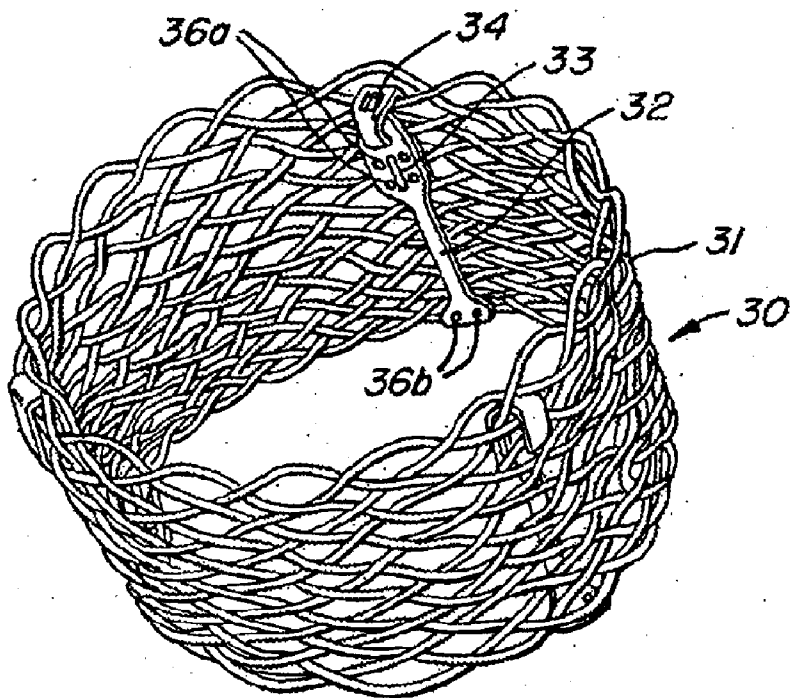

FIG. 2B

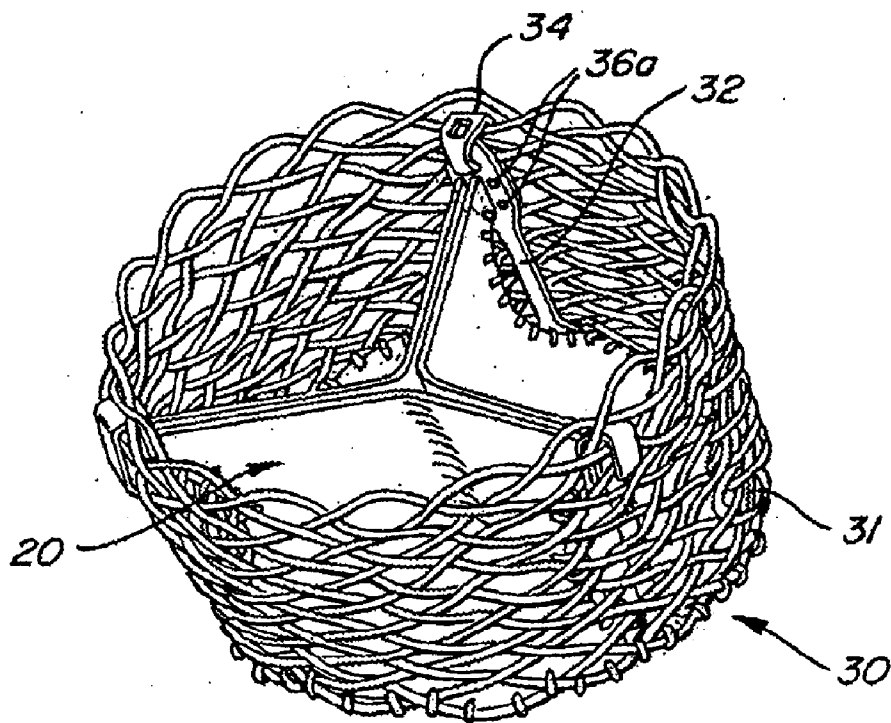

FIG. 2C

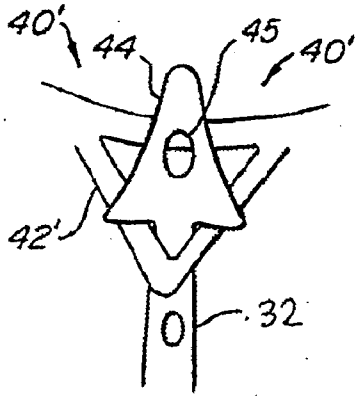

FIG. 2D

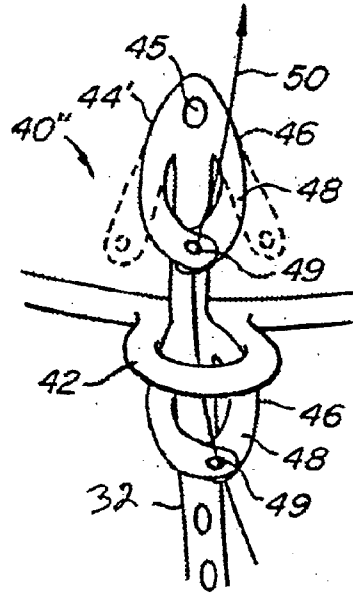

FIG. 2E

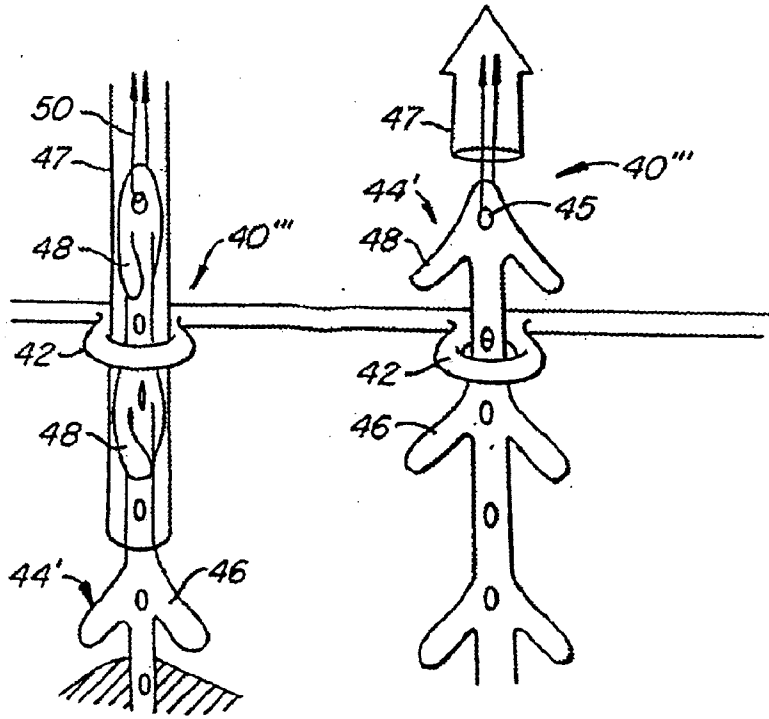

FIG. 2F

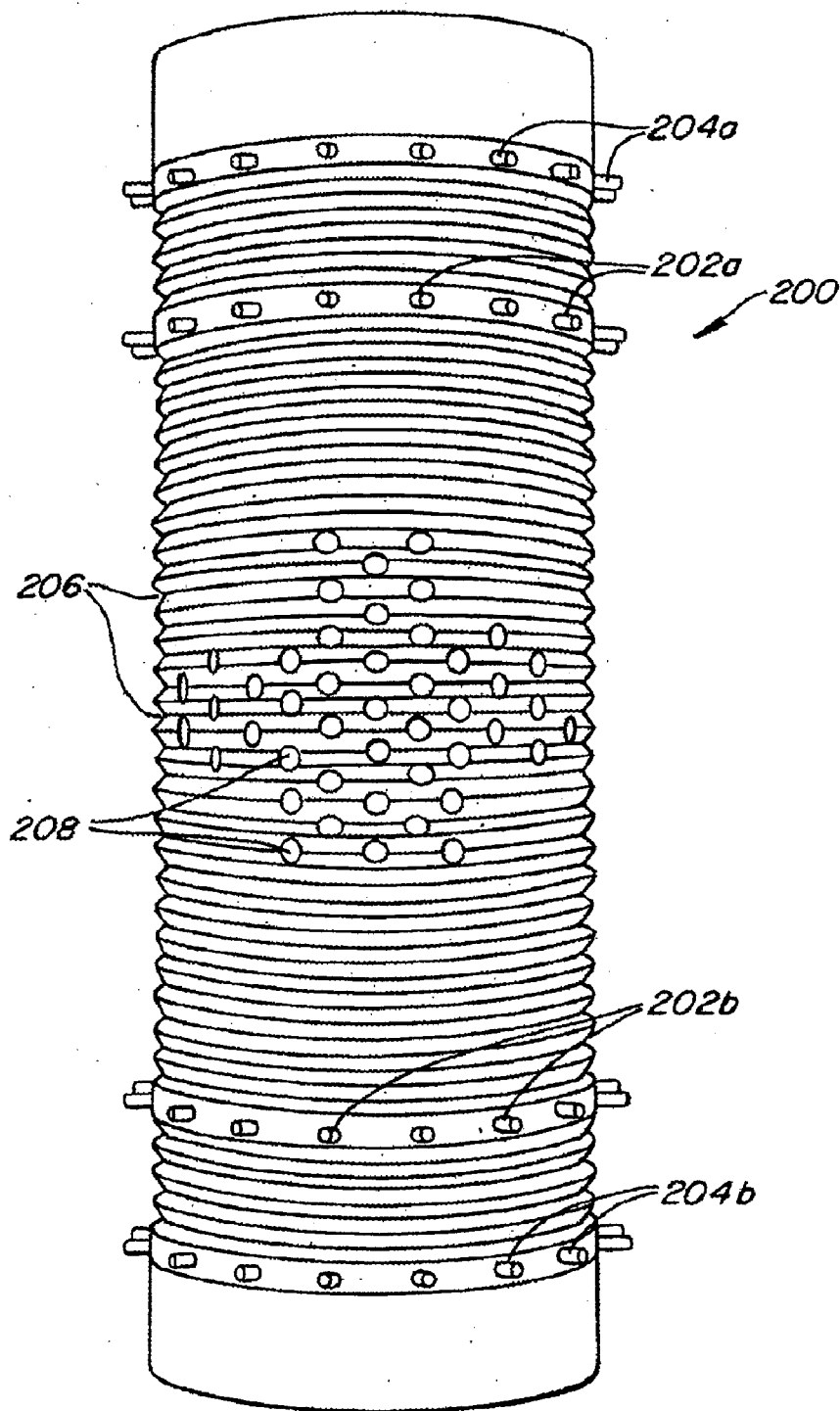

FIG. 3

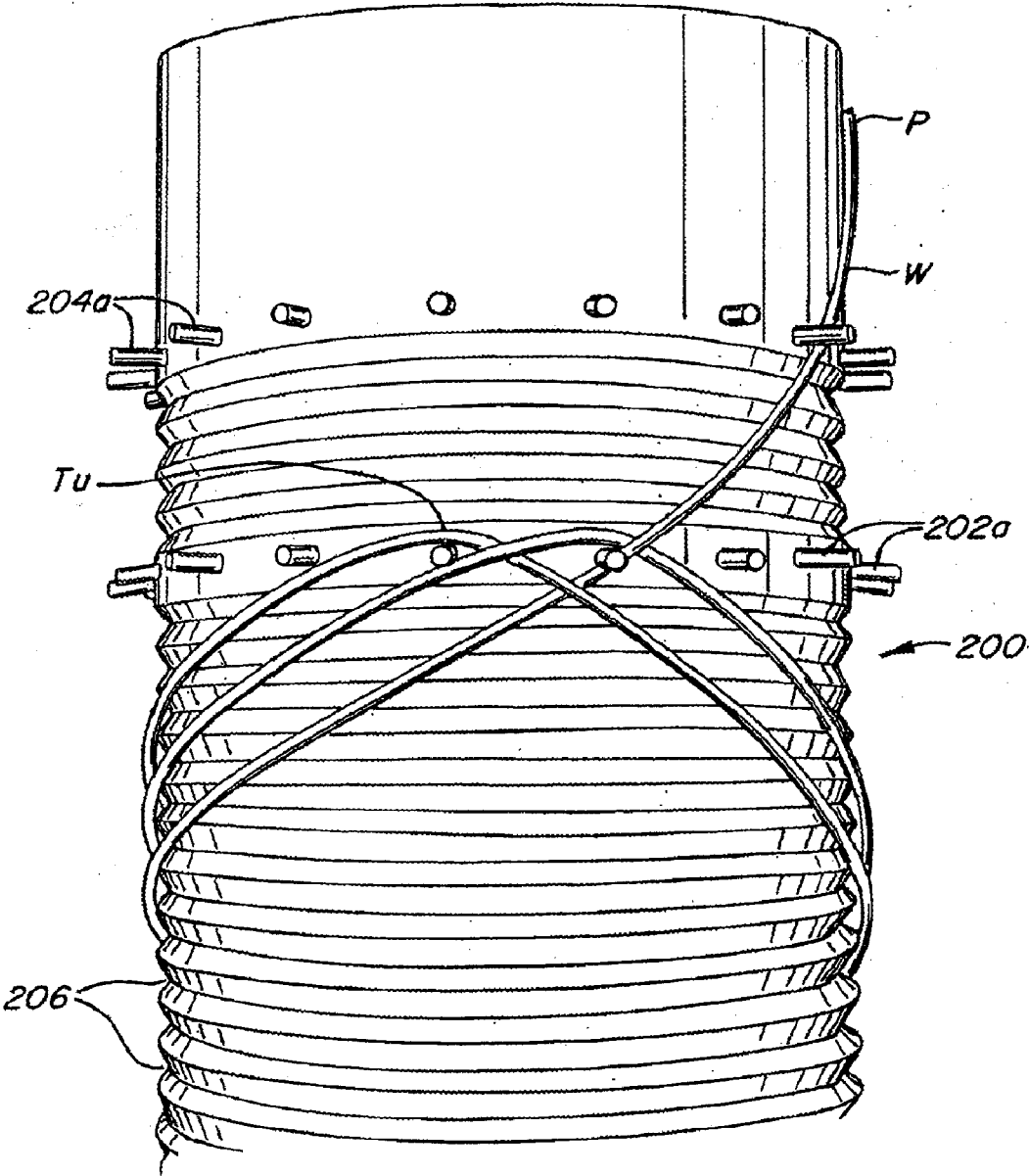

FIG. 4A

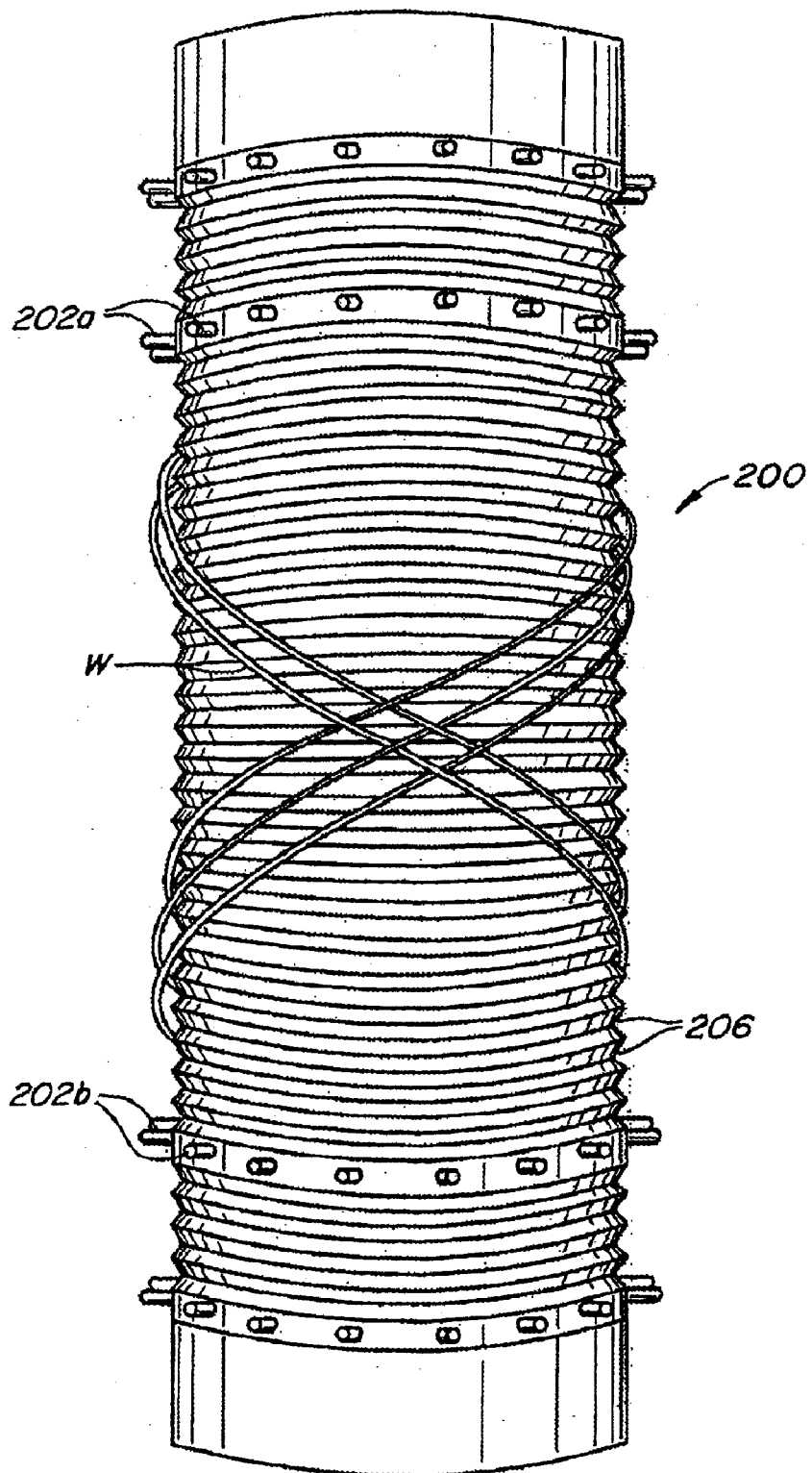

FIG. 4B

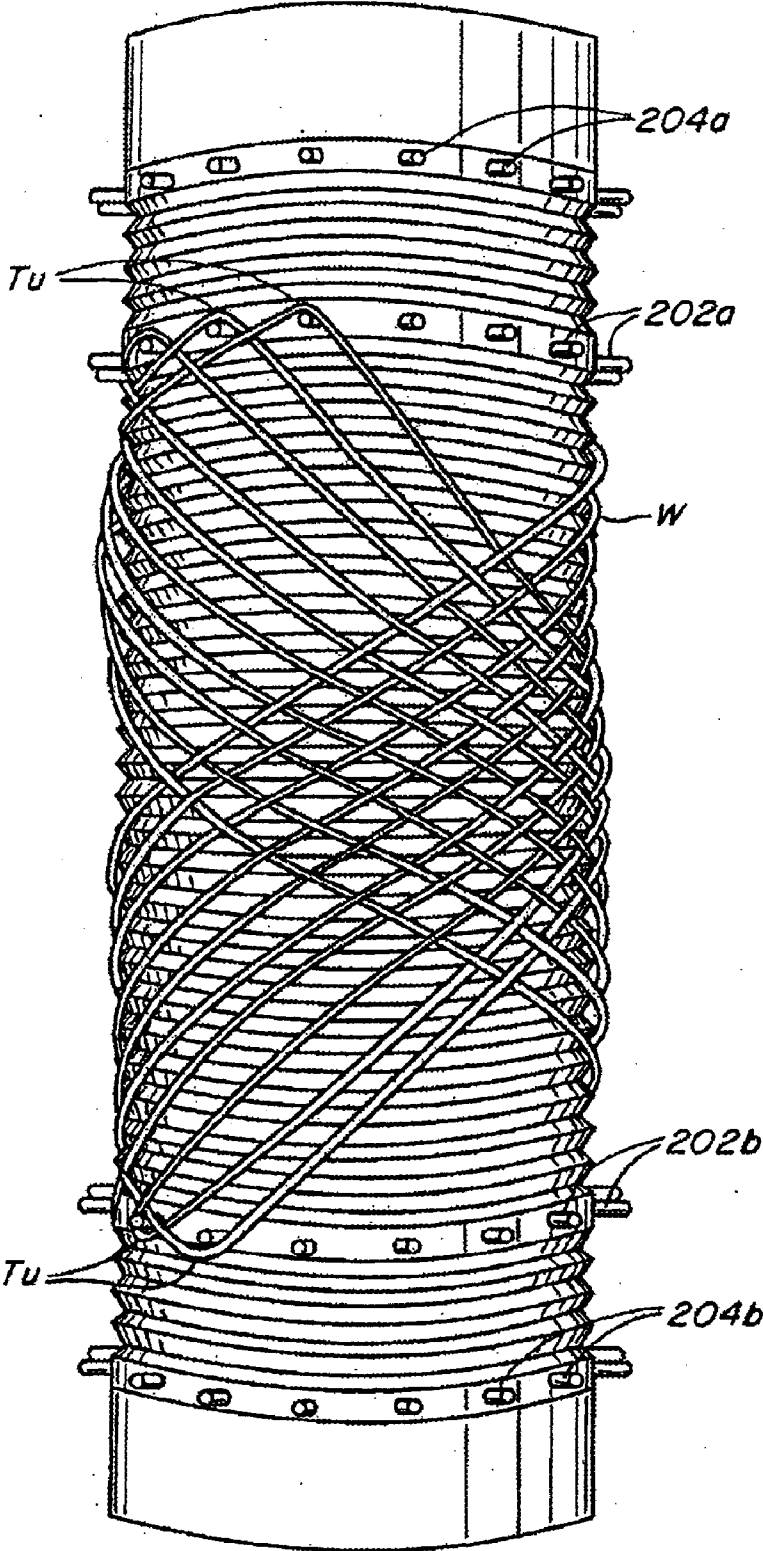

FIG. 4C

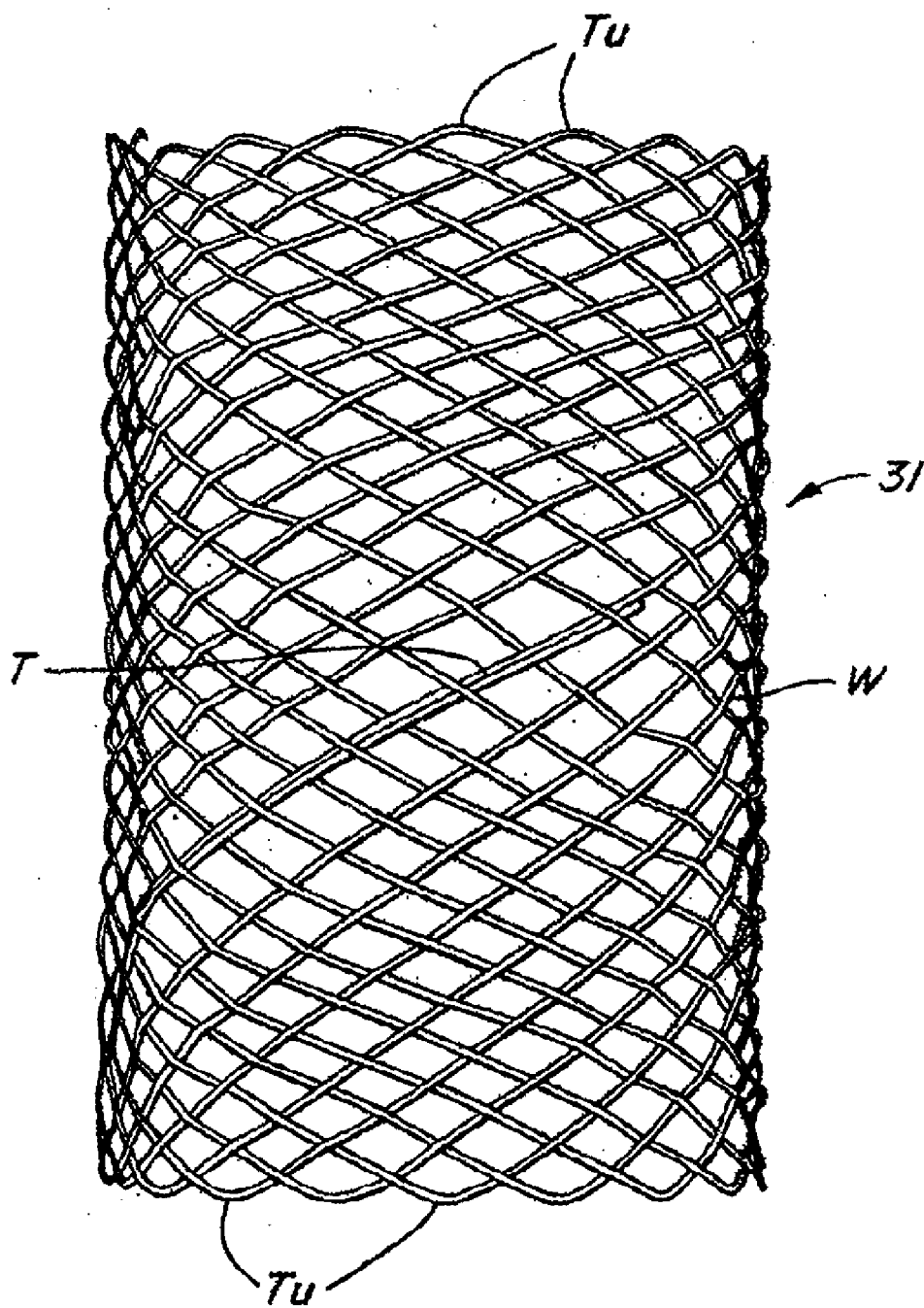

FIG. 4D

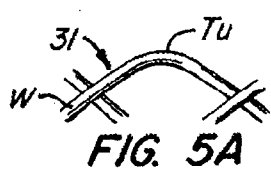

FIG. 5A

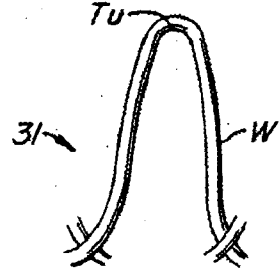

FIG. 5B

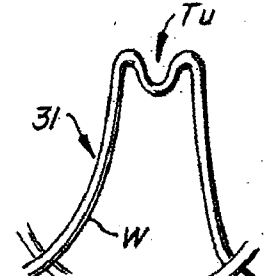

FIG. 5C



FIG. 5D

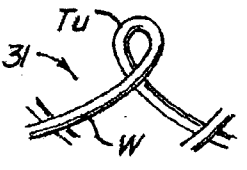

FIG. 5E

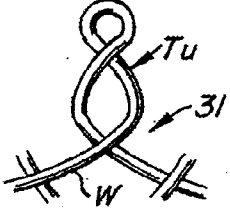

FIG. 5F

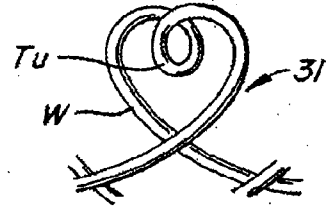

FIG. 5G

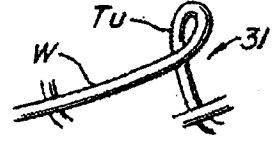

FIG. 5H



FIG. 5I

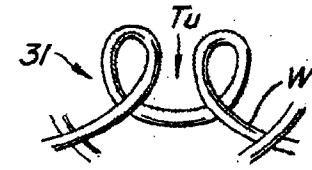

FIG. 5J

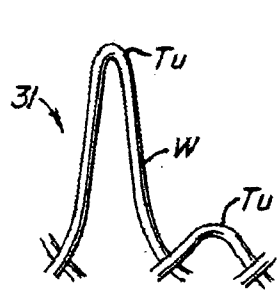

FIG. 5K

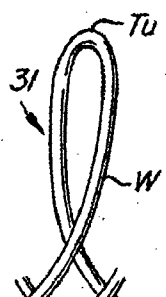

FIG. 5L

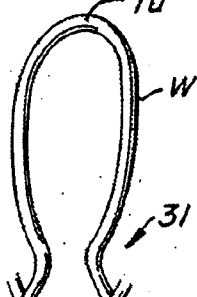

FIG. 5M

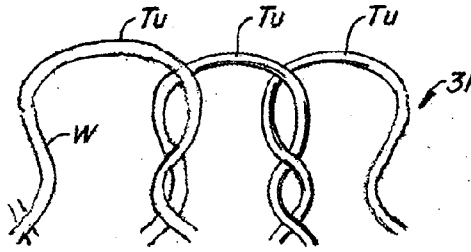

FIG. 5N

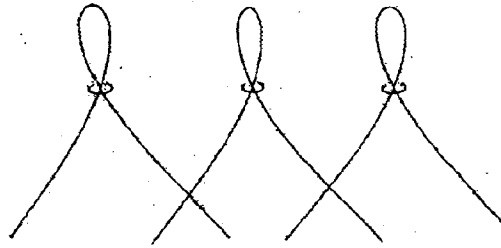

FIG. 5D

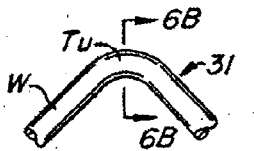

FIG. 6A

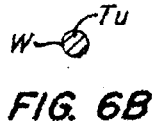

FIG. 6B

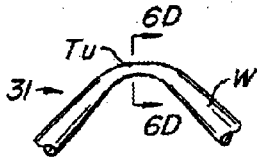

FIG. 6C

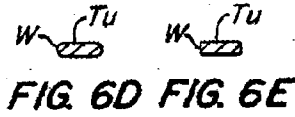

FIG. 6D FIG. 6E

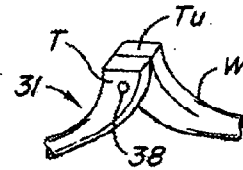

FIG. 7A

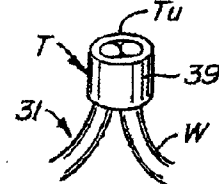

FIG. 7B

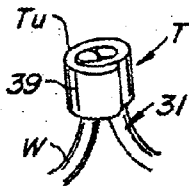

FIG. 7C

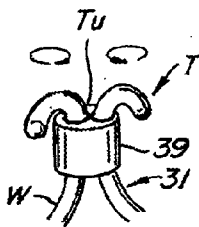

FIG. 7D

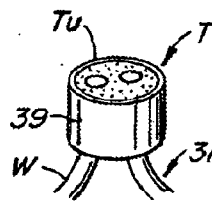

FIG. 7E

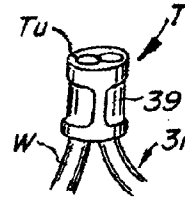

FIG. 7F

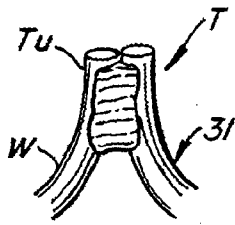

FIG. 7G

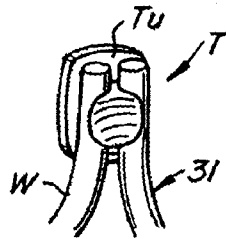

FIG. 7H

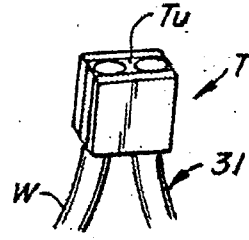

FIG. 7I

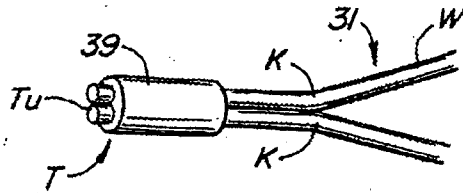

FIG. 7J

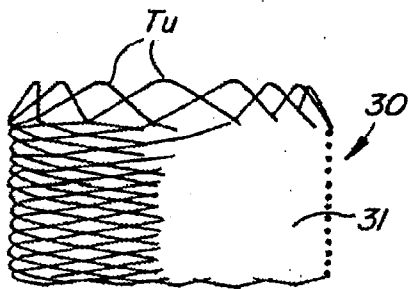

FIG. 8A

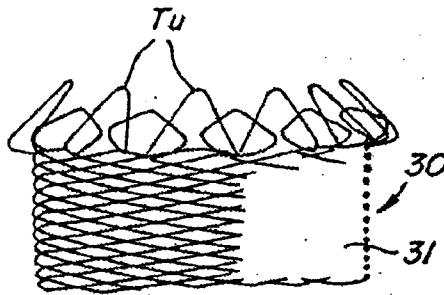

FIG. 8B

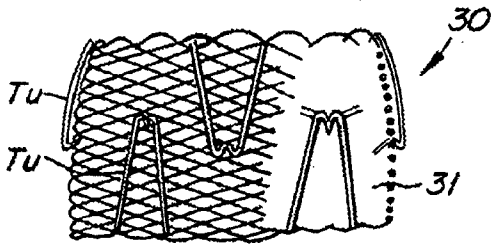

FIG. 9A

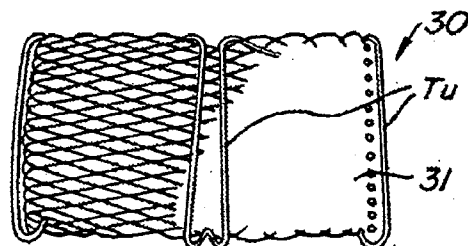

FIG. 9B

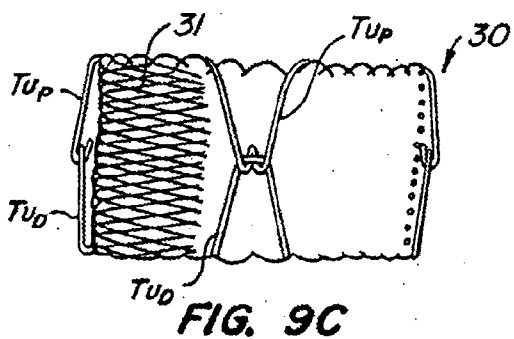

FIG. 9C

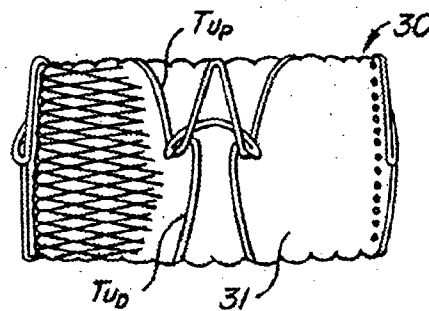

FIG. 9D

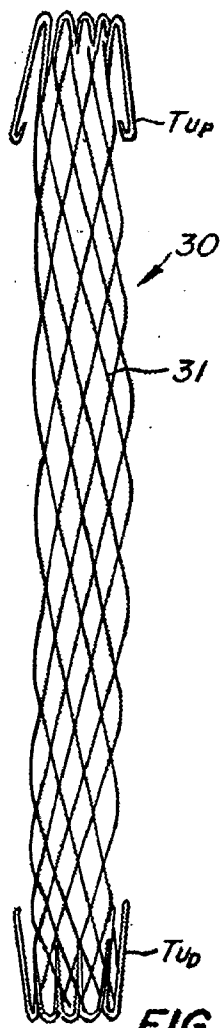

FIG. 9E

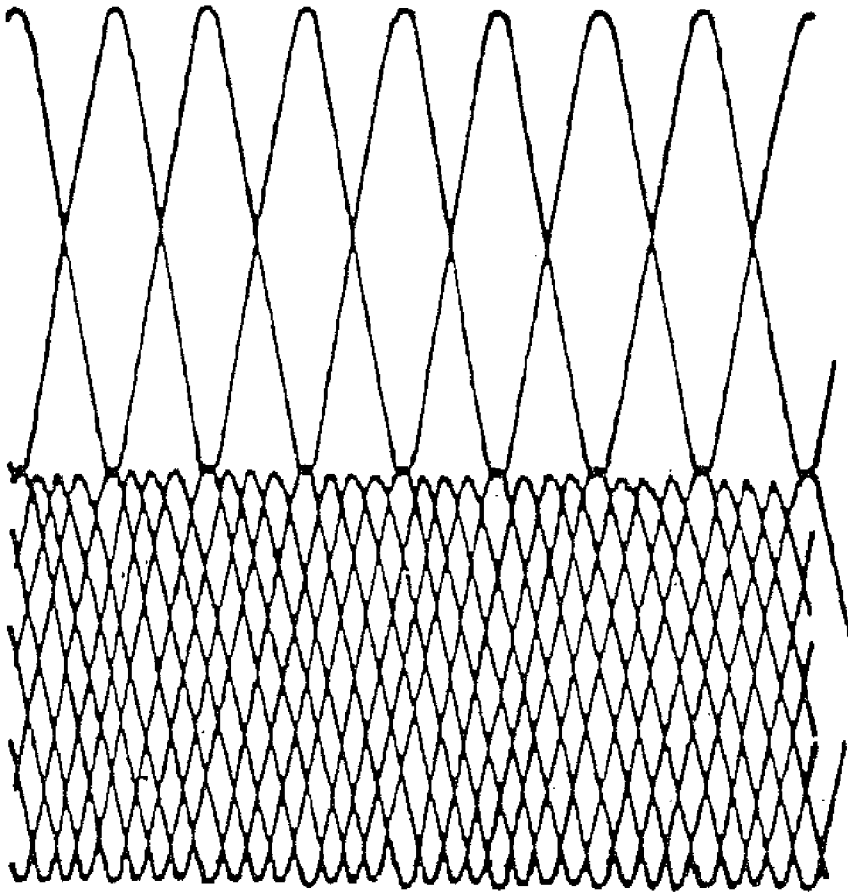

FIG. 10A

FIG. 10B

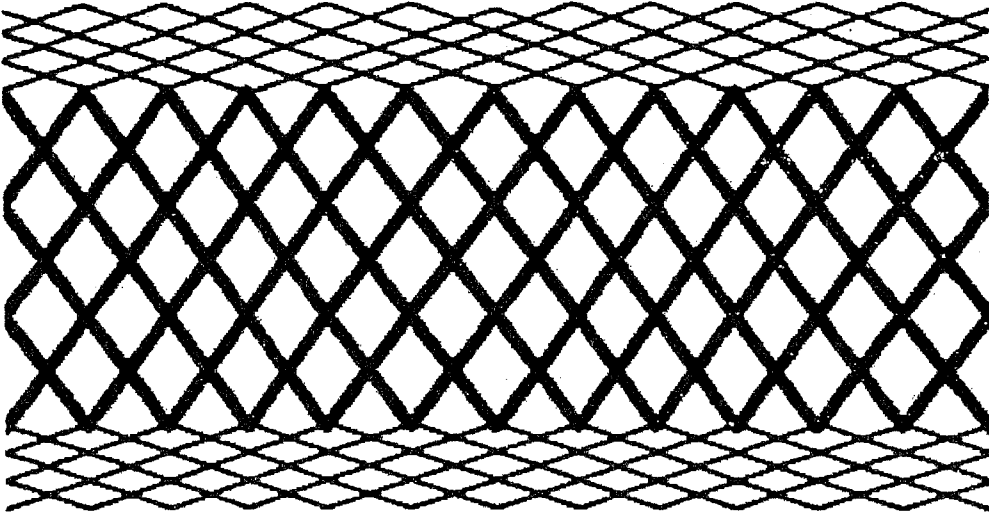

FIG. 10C

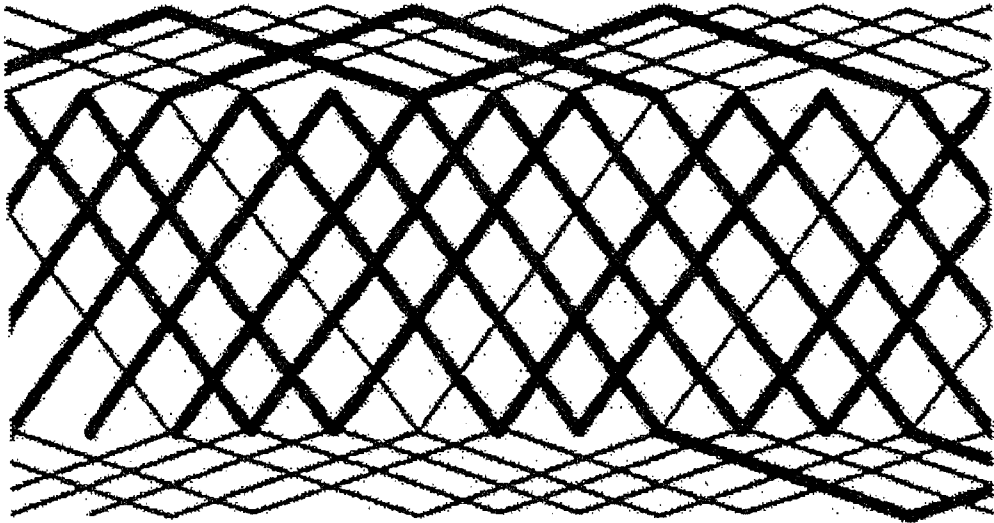

FIG.10D

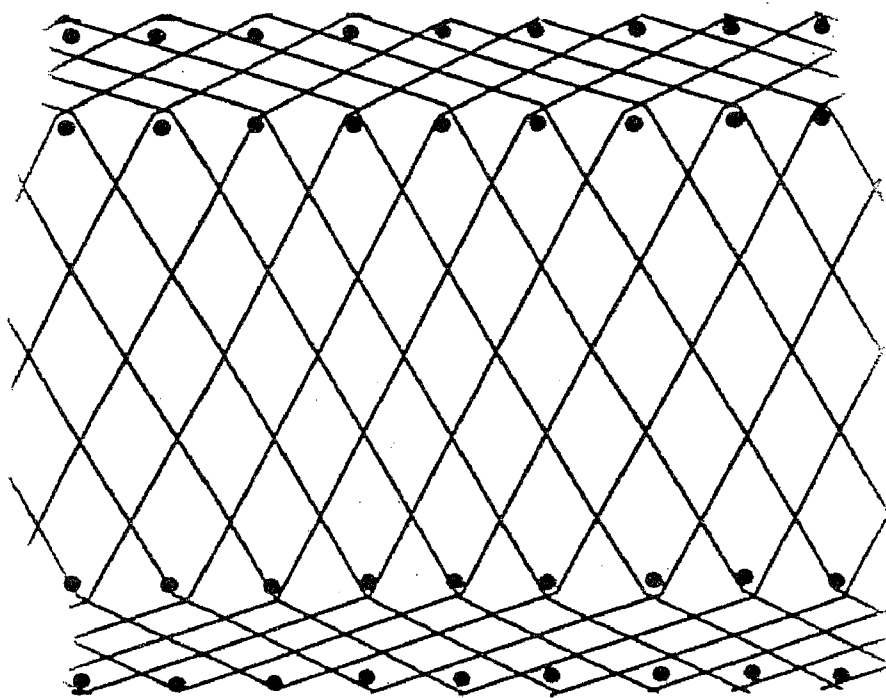

FIG.11A

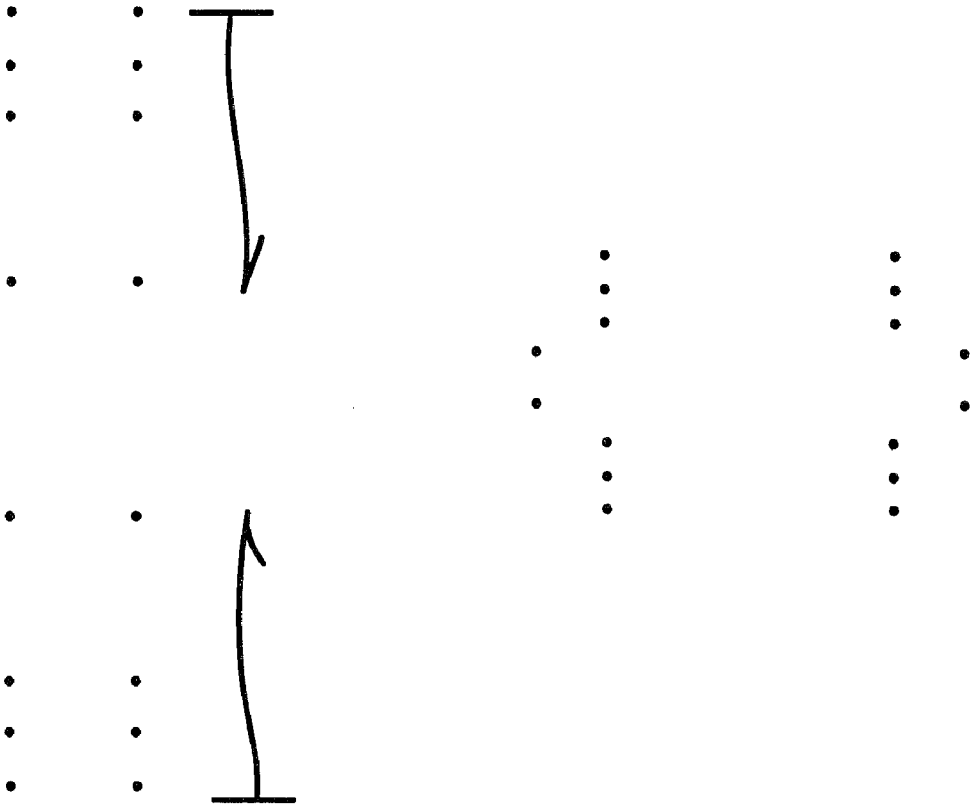

FIG.11B



FIG.11C



FIG.11D



FIG. 11E



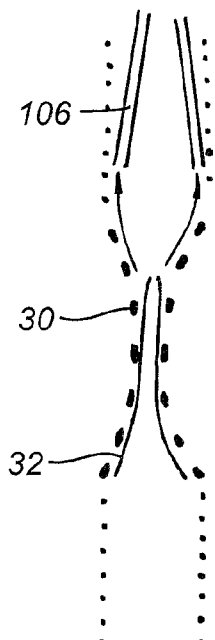

FIG. 12A

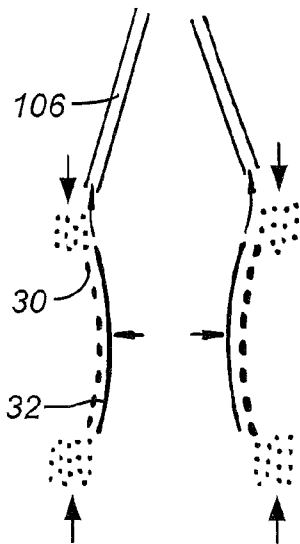

FIG. 12B

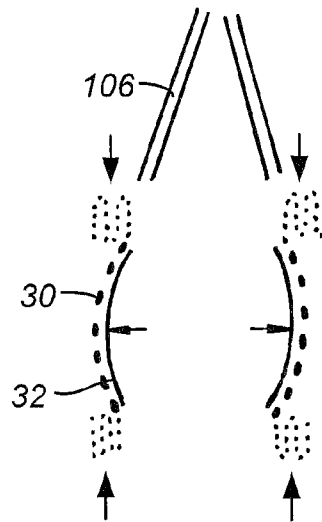

FIG. 12C



FIG. 12D

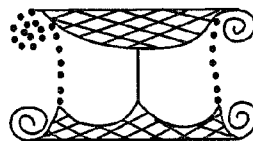

FIG. 12E

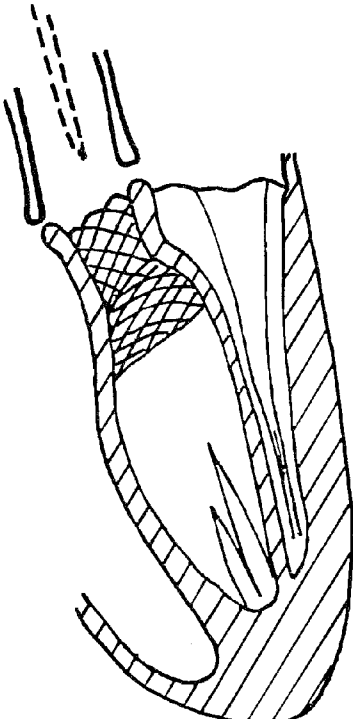

FIG. 13A

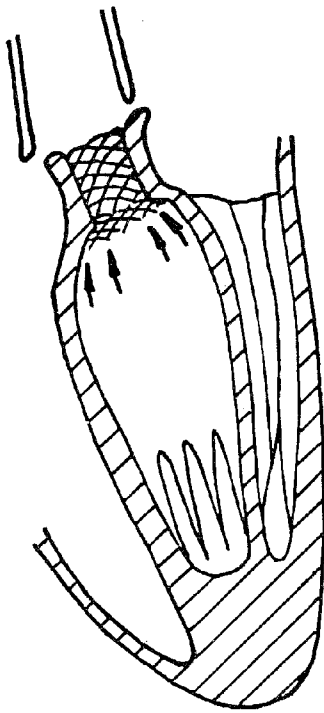

FIG. 13B

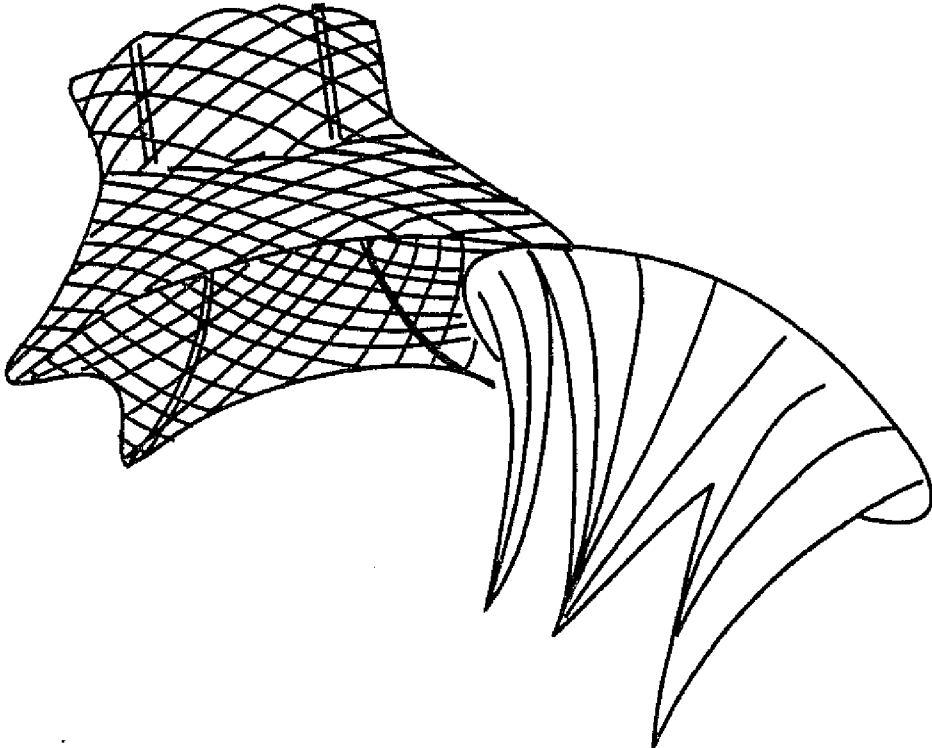

FIG. 14A

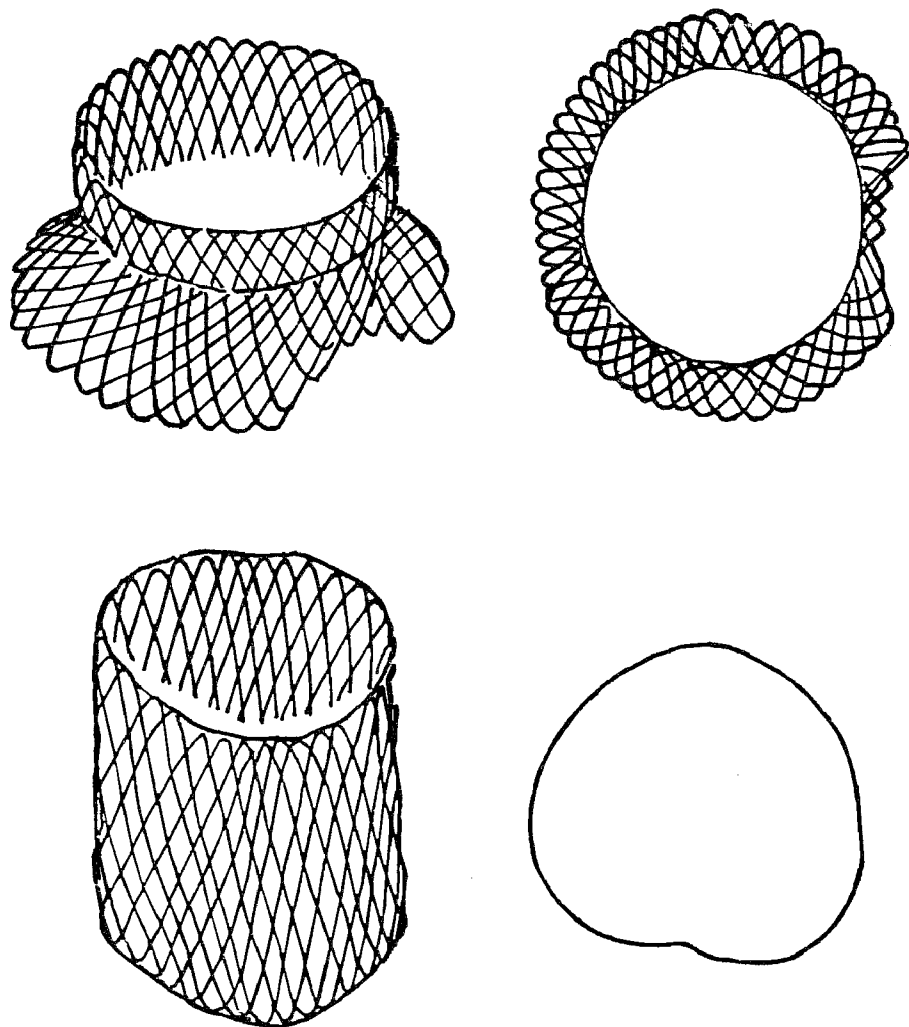

FIG. 14B

METHODS AND APPARATUS FOR ENDOVASCULARLY REPLACING A PATIENT'S HEART VALVE

CROSS REFERENCE TO RELATED APPLICATIONS

[0001] This application is a continuation of U.S. application Ser. No. 12/028,452 Filed Feb. 8, 2008, which is a continuation of U.S. application Ser. No. 10/893,143 filed Jul. 15, 2004, now U.S. Pat. No. 7,329,279; which application is a continuation-in-part of U.S. application Ser. No. 10/746,280, filed Dec. 23, 2003. These applications are incorporated by reference as if fully set forth herein.

BACKGROUND OF THE INVENTION

[0002] Heart valve surgery is used to repair or replace diseased heart valves. Valve surgery is an open-heart procedure conducted under general anesthesia. An incision is made through the patient's sternum (sternotomy), and the patient's heart is stopped while blood flow is rerouted through a heart-lung bypass machine.

[0003] Valve replacement may be indicated when there is a narrowing of the native heart valve, commonly referred to as stenosis, or when the native valve leaks or regurgitates. When replacing the valve, the native valve is excised and replaced with either a biologic or a mechanical valve. Mechanical valves require lifelong anticoagulant medication to prevent blood clot formation, and clicking of the valve often may be heard through the chest. Biologic tissue valves typically do not require such medication. Tissue valves may be obtained from cadavers or may be porcine or bovine, and are commonly attached to synthetic rings that are secured to the patient's heart.

[0004] Valve replacement surgery is a highly invasive operation with significant concomitant risk. Risks include bleeding, infection, stroke, heart attack, arrhythmia, renal failure, adverse reactions to the anesthesia medications, as well as sudden death. Two to five percent of patients die during surgery.

[0005] Post-surgery, patients temporarily may be confused due to emboli and other factors associated with the heart-lung machine. The first 2-3 days following surgery are spent in an intensive care unit where heart functions can be closely monitored. The average hospital stay is between 1 to 2 weeks, with several more weeks to months required for complete recovery.

[0006] In recent years, advancements in minimally invasive surgery and interventional cardiology have encouraged some investigators to pursue percutaneous replacement of the aortic heart valve. See, e.g., U.S. Pat. No. 6,168,614. In many of these procedures, the replacement valve is deployed across the native diseased valve to permanently hold the valve open, thereby alleviating a need to excise the native valve and to position the replacement valve in place of the native valve.

[0007] In the endovascular aortic valve replacement procedure, accurate placement of aortic valves relative to coronary ostia and the mitral valve is critical. Some self-expanding valve anchors have had very poor accuracy in deployment, however. In a typical deployment procedure, the proximal end of the stent is not released from the delivery system until accurate placement is verified by fluoroscopy. The stent often jumps to another position once released, making it impossible

to know where the ends of the stent will be after release with respect to the native valve, the coronary ostia and the mitral valve.

[0008] Also, visualization of the way the new valve is functioning prior to final deployment is very desirable. Due to the jumping action of some self-expanding anchors, and because the replacement valve is often not fully functional before final deployment, visualization of valve function and position prior to final and irreversible deployment is often impossible with these systems.

[0009] Another drawback of prior art self-expanding replacement heart valve systems is their relative lack of radial strength. In order for self-expanding systems to be easily delivered through a delivery sheath, the metal needs to flex and bend inside the delivery catheter without being plastically deformed. Expandable stent designs suitable for endovascular delivery for other purposes may not have sufficient radial strength to serve as replacement heart valve anchors. For example, there are many commercial arterial stent systems that apply adequate radial force against the artery wall to treat atherosclerosis and that can collapse to a small enough of a diameter to fit inside a delivery catheter without plastically deforming. However when the stent has a valve fastened inside it, and that valve must reside within the heart, as is the case in aortic valve replacement, the anchoring of the stent to vessel walls takes significantly more radial force, especially during diastole. The force to hold back arterial pressure and prevent blood from going back inside the ventricle during diastole will be directly transferred to the stent/vessel wall interface. Therefore, the amount of radial force required to keep the self-expanding stent/valve in contact with the vessel wall and not sliding is much higher than in stents that do not have valves inside of them. Moreover, a self-expanding stent without sufficient radial force will end up dilating and contracting with each heartbeat, thereby distorting the valve, affecting its function and possibly causing it to migrate and dislodge completely. Simply increasing strut thickness of the self-expanding stent is not a good solution as it increases profile and/or a risk of plastic deformation of the self-expanding stent.

[0010] In view of drawbacks associated with previously known techniques for endovascularly replacing a heart valve, it would be desirable to provide methods and apparatus that overcome those drawbacks.

SUMMARY OF THE INVENTION

[0011] One aspect of the present invention provides methods for replacing a native aortic valve. Such methods involve endovascularly delivering a replacement valve and an anchor having an expandable braid. Delivery is preferably made to a site within the native aortic valve. Delivery is preferably made by actively foreshortening the anchor to radially expand the anchor to an expanded shape to secure the anchor at the anchor site. In some embodiments, the methods further include the step of locking the anchor in an expanded shape. In some embodiments, the methods include expanding a first step region of the anchor to a first diameter and a second region of the anchor to a second diameter larger than the first diameter.

[0012] In some embodiments, the foreshortening step of the methods herein comprises actively foreshortening the anchor to radially expand the anchor to an expanded shape to secure the anchor at the anchor site while avoiding interference with a mitral valve. In some embodiments, the foreshort-

ening step comprises actively foreshortening the anchor to radially expand the anchor to a radially symmetrical expanded shape, a bilaterally symmetrical expanded shape or an asymmetrical expanded shape.

[0013] In some embodiments, the anchor is allowed to self-expand prior to the foreshortening step. In some embodiments, the foreshortening step comprises applying a proximally directed force on a deployment system interface at a proximal end or a distal end of the anchor. In some embodiments, the foreshortening step comprises applying a distally directed force on a deployment system interface at a proximal end of the anchor.

Incorporation By Reference

[0014] All publications and patent applications mentioned in this specification are herein incorporated by reference to the same extent as if each individual publication or patent application was specifically and individually indicated to be incorporated by reference.

BRIEF DESCRIPTION OF THE DRAWINGS

[0015] The novel features of the invention are set forth with particularity in the appended claims. A better understanding of the features and advantages of the present invention will be obtained by reference to the following detailed description that sets forth illustrative embodiments, in which the principles of the invention are utilized, and the accompanying drawings of which:

[0016] FIGS. 1A and 1B are schematic top views of an anchor and valve apparatus in accordance with the present invention. FIG. 1 illustrates the apparatus in a collapsed delivery configuration within a delivery system. FIG. 1B illustrates the apparatus in an expanded configuration partially deployed from the delivery system.

[0017] FIGS. 2A-2F are schematic isometric views detailing an anchor of the apparatus of FIG. 1 in the collapsed delivery configuration and the expanded deployed configuration, as well as the full apparatus in the deployed configuration.

[0018] FIG. 3 is a schematic top view of an apparatus for fabricating braided anchors in accordance with the present invention.

[0019] FIGS. 4A-4D are schematic top views illustrating a method of using the apparatus of FIG. 3 to fabricate a braided anchor of the present invention.

[0020] FIGS. 5A-5O are schematic detail views illustrating features of braid cells at an anchor edge.

[0021] FIGS. 6A-6E illustrate further features of braid cells at an anchor edge.

[0022] FIGS. 7A-7J are schematic detail views terminations for one or more wire strands forming anchors of the present invention.

[0023] FIGS. 8A and 8B are schematic side views of alternative embodiments of the anchor portion of the apparatus of the present invention.

[0024] FIGS. 9A-9E are schematic side views of further alternative embodiments of the anchor portion of the apparatus of the present invention.

[0025] FIGS. 10A-10D are schematic views of different weave configurations.

[0026] FIGS. 11A-11E are schematic side views of various braided anchor configurations.

[0027] FIGS. 12A-12E are schematic side views of a deployment process.

[0028] FIGS. 13A and 13B illustrate a braided anchor in the heart.

[0029] FIGS. 14A and 14B illustrate a bilaterally symmetrical anchor and an asymmetric anchor, respectively.

DETAILED DESCRIPTION OF THE INVENTION

[0030] The present invention relates to a delivery system, apparatus and methods for endovascularly delivering and deploying an aortic prosthesis within a patient's native heart valve, referred to here out as replacing a patient's heart valve. The delivery system includes a sheath assembly and a guide wire for placing the apparatus endovascularly within a patient and a user control allowing manipulation of the aortic prosthesis. The apparatus includes an anchor and a replacement valve. The anchor includes an expandable braid. In preferred embodiments, the expandable braid includes closed edges. The replacement valve is adapted to be secured within the anchor, and as such, be delivered endovascularly to patient's heart to replace the patient's native heart valve. More preferably, the apparatus and methods of the present invention contemplate the replacement of a patient's aortic valve.

[0031] FIGS. 1A and 1B illustrate one embodiment of a delivery system and apparatus in accordance with the present invention is described. As illustrated by FIG. 1A, apparatus 10 may be collapsed for delivery within a delivery system 100. Delivery system 100 includes a guidewire 102, a nosecone 104, control tubes 106 coupled to a multi-lumen shaft 108, an external sheath 110 having a proximal handle 111, and a control handle 120. Delivery system 100 further comprises distal region control wires (not shown), which pass through one or more lumens of shaft 108 and are reversibly coupled to posts 32 of anchor 30 for manipulating a distal region of apparatus 10. The delivery system also comprises proximal region control wires 112 that pass through one or more lumens of shaft 108 and control tubes 106 (also known as fingers) to reversibly couple the control tubes to a proximal region of anchor 30. The control wires may comprise, for example, strands of suture, or metal or polymer wires.

[0032] Control handle 120 is coupled to multi-lumen shaft 108. A knob 122 disposed in slot 123 is coupled to the distal region control wires for controlling movement of the distal region of apparatus 10. Likewise, a knob 124 disposed in slot 125 is coupled to proximal region control wires 112 for control of the proximal region of apparatus 10. Handle 120 may also have a knob 126 for, e.g., decoupling the proximal and/or distal region control wires from apparatus 10, or for performing other control functions.

[0033] Apparatus 10 has an anchor 30 and a replacement valve 20. Anchor 30 preferably comprises a braid. Such braid can have closed ends at either or both its ends. Replacement valve 20 is preferably coupled to the anchor along posts 32. Post 32 therefore, may function as valve support and may be adapted to support the replacement valve within the anchor. In the embodiment shown, there are three posts, corresponding to the valve's three commissure points. The posts can be attached to braid portion of anchor 30. The posts can be attached to the braid's distal end, as shown in FIG. 2A, central region, or proximal end. Replacement valve 20 can be composed of a synthetic material and/or may be derived from animal tissue. Replacement valve 20 is preferably configured to be secured within anchor 30.

[0034] Anchor 30 has also a plurality of buckles 34 attached to its proximal region, one for each post 32. Posts 32 and buckles 34 form a two-part locking mechanism for maintaining anchor 30 in a deployed or expanded configuration (e.g., as illustrated in FIGS. 1B, 2B and 2C).

[0035] In this embodiment, anchor 30 is formed from collapsible and expandable wire braid. Anchor braid 30 is preferably self-expanding and is preferably formed from a material such as Nitinol, cobalt-chromium steel or stainless steel wire using one or more strands of wire. While the illustrated embodiment is formed from a single strand of wire, in other embodiments may benefit from a wire braid formed of 2-20 wires, more preferably 3-15 wires, or more preferably 4-10 wires.

[0036] Delivery and deployment of braided anchor 30 is similar to the delivery and deployment of the anchors described in U.S. patent application Ser. No. 10/746,280 filed Dec. 23, 2003, the disclosure of which is incorporated herein by reference. Specifically, in one embodiment described below, during deployment braided anchor 30 is actively foreshortened by proximally retracting the distal region control wires relative to control tubes 106 to expand and lock the anchor in place. In some embodiments, foreshortening expands anchor 30 to a radially symmetrical, bilaterally symmetrical, or asymmetrical expanded shape (as further described below). The foreshortening step can include expanding a first region of the anchor to a first diameter and a second region of the anchor to a second diameter larger than the first diameter. A third region may also be expanded to a diameter larger than the first diameter. The expansion of various regions of the anchor (e.g., the distal region) can be especially useful in locating the aortic valve and centering the anchor within it. Preferably, the secured anchor does not interfere with the mitral valve or the ostias. In some embodiments, the anchor is allowed to self expand prior to the foreshortening step.

[0037] As seen in FIG. 1, after endovascular delivery through sheath 110 to the vicinity of the patient's native valve (such as the aortic valve), apparatus 10 may be expanded from the collapsed delivery configuration of FIG. 1A to the expanded deployed configuration of FIG. 1B using delivery system 100. To deploy apparatus 10, external sheath 110 may be retracted relative to apparatus 10 by proximally retracting sheath handle 111 relative to control handle 120. Sheath 110 is thereby removed from the exterior of apparatus 10, permitting the anchor 30 to self-expand. In preferred embodiments, anchor 30 includes sheathing features as depicted in FIGS. 5B thru 5M or FIG. 6, 7A, or 7D adapted to reduce sheathing force. Sheathing force is defined as the force required to push the sheath distally over the anchor or the force required to pull the anchor proximally into the sheath (as for purposes of retrieving the anchor). For example, if anchor braid 30 is composed of a shape memory material, it may self-expand to or toward its "at-rest" configuration. This "at rest" configuration of the braid can be, for example its expanded configuration, a collapsed configuration, or a partially expanded configuration between the collapsed configuration and the expanded configuration. In preferred embodiments, the anchor's at-rest configuration is between the collapsed configuration and the expanded configuration. Depending on the "at rest" diameter of the braid and the diameter of the patient's anatomy at the chosen deployment location, the anchor may or may not self-expand to come into contact with the diameter of the patient's anatomy at that location.

[0038] In its collapsed configuration, anchor 30 preferably has a collapsed delivery diameter between about 3 to 30 Fr, or more preferably 6 to 28 Fr, or more preferably 12 to 24 Fr. In some embodiments, anchor 30 in its collapsed configuration will have a length ranging from about 5 to about 170, more preferably from about 10 to about 160, more preferably from about 15 to about 150, more preferably from about 20 to about 140 mm, or more preferably from about 25 mm to about 130.

[0039] Similarly, in its expanded configuration, anchor 30 preferably has a diameter ranging between about 10 to about 36 mm, or more preferably from about 24 to about 33 mm, or more preferably from about 24 to about 30 mm. In some embodiments, anchor 30 in its expanded configuration will have a length ranging from about 1 to about 50, more preferably from about 2 to about 40, more preferably from about 5 to about 30, or more preferably from about 7 to about 20 mm.

[0040] Overall, the ratio of deployed to collapsed/sheathed lengths is preferably between about 0.05 and 0.5, more preferably about 0.1 to 0.35, or more preferably about 0.15 to 0.25. In any of the embodiments herein, anchor 30 in its expanded configuration preferably has a radial crush strength that maintains the anchor substantially undeformed in response to a pressure of up to 0.5 atm directed substantially radially inward toward the central axis, or more preferably up to 2 atm directed substantially radially inward toward the central axis. In addition, in any of the embodiments herein, the anchor has an axial spring constant of between about 10 to 250 g/cm, more preferably between about 20 to 200 g/cm, or more preferably between about 40 to 160 g/cm. In addition, in any of the embodiments herein, the anchor is preferably adapted to support the replacement valve at the anchor site in response to a differential pressure of up to 120 mm Hg, more preferably up to 240 mm Hg, or more preferably up to 320 mm Hg.

[0041] These parameters are not intended to be limiting. Additional parameters within the scope of the present invention will be apparent to those of skill in the art.

[0042] As seen in FIG. 1B, anchor 30 may be expanded to a fully deployed configuration from a partial deployed configuration (e.g., self-expanded configuration) by actively foreshortening anchor 30 during endovascular deployment. As described in more detail in U.S. patent application Ser. No. 10/746,280, the distal region of anchor 30 may be pulled proximally via a proximally directed force applied to posts 32 via a distal deployment system interface. The distal deployment system interface is adapted to expand radially during application of a proximally directed force on the distal end of the anchor. In some embodiments, foreshortening of the apparatus involves applying a proximally directed force on a deployment system interface at the distal end of the anchor. In other embodiments, foreshortening of the apparatus involves applying a distally directed force on a deployment system interface at the proximal end of the anchor. More preferably, proximally or distally directed forces on the deployment system interface do not diametrically constrain the opposite end of the anchor--distal or proximal end, respectively. When a proximally directed force is applied on the deployment system interface, it is preferably applied without passing any portion of a deployment system through a center opening of the replacement valve.

[0043] The distal deployment system interface may include control wires that are controlled, e.g., by control knob 122 of control handle 120. Similarly, the proximal regions of anchor 30 may be pushed distally via a proximal deployment system

interface at the proximal end of the anchor. The proximal deployment system interface is adapted to permit deployment system to apply a distally directed force to the proximal end of anchor **30** through, e.g., fingers **106**, which are controlled by, e.g., Control knob **124** of control handle **120**. The proximal deployment system interface may be further adapted to expand radially during application of a distally directed force on the proximal end of the anchor. Preferably, the proximal deployment system interface is adapted to permit deployment system to apply a distally directed force on the proximal end of the anchor system through a plurality of deployment system fingers or tubes **106**. Such expansion optionally may be assisted via inflation of a balloon catheter (not shown) reversibly disposed within apparatus **10**, as described in U.S. application Ser. No. 10/746,280.

[0044] Once anchor **30** is fully deployed, posts **32** and buckles **34** of anchor **30** may be used to lock and maintain the anchor in the deployed configuration. In one embodiment, the control wires attached to posts **32** are threaded through buckles **34** so that the proximally directed force exerted on posts **32** by the control wires during deployment pulls the proximal locking end of posts **32** toward and through buckles **34**. Such lock optionally may be selectively reversible to allow for repositioning and/or retrieval of apparatus **10** during or post-deployment. Apparatus **10** may be repositioned or retrieved from the patient until the two-part locking mechanism of posts **32** and buckles **34** of anchor **30** have been actuated. When the lock is selectively reversible, the apparatus may be repositioned and/or retrieved as desired, e.g., even after actuation of the two-part locking mechanism. Once again, further details of this and other anchor locking structures may be found in U.S. patent application Ser. No. 10/746,280. Locking mechanisms used herein may also include a plurality of levels of locking wherein each level of locking results in a different amount of expansion. For example, the proximal end of the post can have multiple configurations for locking within the buckle wherein each configuration results in a different amount of anchor expansion.

[0045] When apparatus **10** is placed across a patient's diseased heart valve, anchor **30** may be used to displace the patient's native valve leaflets, and replacement valve **20** will thereafter serve in place of the native valve. After final positioning and expansion, apparatus **10** may be decoupled from delivery system **100** by decoupling the proximal and distal region control wires from anchor **30**. Decoupling may be actuated using knob **126** of handle **120**. After decoupling, delivery system **100** then may be removed from the patient, thereby completing endovascular replacement of a patient's heart valve.

[0046] Prior to implantation of replacement valve apparatus described herein, it may be desirable to perform a valvuloplasty on the patient's diseased valve by inserting a balloon into the valve and expanding it using, e.g., saline mixed with a contrast agent. In addition to preparing the valve site for implant, fluoroscopic viewing of the valvuloplasty will help determine the appropriate size of replacement valve implant to use.

[0047] FIGS. 2A-F show further details of anchor **30** of apparatus **10**. FIG. 2A shows the apparatus in a collapsed configuration, such as for delivery within a sheath or other lumen or for retrieval and recapture into a sheath or other lumen. FIGS. 2B and 2C show the anchor and valve in an expanded and locked configuration.

[0048] As shown in FIG. 2C, anchor **30** has three posts and three buckles. As seen in FIG. 2C, the three leaflets of replacement valve **20** may be coupled to the three posts **32** also known as valve supports. The posts, unlike the braid, do not collapse or expand. In some embodiments a post **32** has one or more proximal slots **33**, at least one proximal hole **36a** and at least one distal hole **36b**. Leaflet tissue may be passed through slot **33** and sutured in place via suture routed through one or more proximal holes **36a**. Other means known in the art for fixing valve leaflets to posts may also be employed.

[0049] Posts **32** may be coupled to anchor braid **30** via one or more distal holes **36b**. For example, anchor braid **30** may be woven through holes **36b**, or a suture may be routed through holes **36b** and tied to the braid. Buckles **34** may likewise be attached to anchor braid **30** via weaving or suturing.

[0050] Alternative locks may be used to lock the anchor of the present invention in the foreshortened configuration. Preferably, a locking mechanism of the present invention can have multiple locking options such that locking can confer a plurality of amounts of expansion. Furthermore, the locking option can be employed asymmetrically to confer non-cylindrical shapes to the anchor. In FIG. 2D, lock **40'** comprises male interlocking element **44** as described previously. However, female interlocking element **42'** illustratively comprises a triangular shape, as compared to the round shape of interlocking element **42** described previously. The triangular shape of female interlocking element **42'** may facilitate mating of male interlocking element **44** with the female interlocking element without necessitating deformation of the male interlocking element.

[0051] In FIG. 2E, lock **40''** comprises alternative male interlocking element **44'** having multiple in-line arrowheads **46** along posts **32**. Each arrowhead comprises resiliently deformable appendages **48** to facilitate passage through female interlocking element **42**. Appendages **48** optionally comprise eyelets **49**, such that control wire **50** or a secondary wire may pass therethrough to constrain the appendages in the deformed configuration. To actuate lock **40''**, one or more arrowheads **46** of male interlocking element **44'** are drawn through female interlocking element **42**, and the wire is removed from eyelets **49**, thereby causing appendages **48** to resiliently expand and actuate lock **40''**.

[0052] Advantageously, providing multiple arrowheads **46** along posts **32** yields a ratchet that facilitates in-vivo determination of a degree of foreshortening imposed upon apparatus of the present invention. Furthermore, optionally constraining appendages **48** of arrowheads **46** via eyelets **49** prevents actuation of lock **40''** (and thus deployment of apparatus of the present invention) even after male element **44'** has been advanced through female element **42**. Only after a medical practitioner has removed the wire constraining appendages **48** is lock **40''** fully engaged and deployment no longer reversible.

[0053] Lock **40'''** of FIG. 1C is similar to lock **40''** of FIG. 2E, except that optional eyelets **49** on appendages **48** have been replaced by optional overtube **47**. Overtube **47** serves a similar function to eyelets **49** by constraining appendages **48** to prevent locking until a medical practitioner has determined that apparatus of the present invention has been foreshortened and positioned adequately at a treatment site. Overtube **47** is then removed, which causes the appendages to resiliently expand, thereby fully actuating lock **40'''**.

[0054] FIG. 3 illustrates an exemplary apparatus for fabricating braided anchors. Such apparatus includes a cylindrical

braiding fixture **200**. The cylindrical braiding fixture **200** comprises proximal circumference of inner posts **202a** separated by a distance x from distal circumference of inner posts **202b**. x can be, for example, 10 to 60 mm, more preferably 20 to 50 mm, or more preferably 30 to 40 mm. Optionally, the fixture may also comprise proximal and distal circumferences of outer posts **204a** and **204b**, respectively. **204a** and **204b** can be situated about 2-10 mm from **202a** and **202b**, respectively. Posts **202a/b** and **204a/b** project from fixture **200** and may be used to route wire, e.g., for forming anchor braid **30**. Inner posts **202a** and **202b** generally facilitate formation of a braid, while outer posts **204a** and **204b** generally facilitate formation of desired features at the ends of the braid, as described hereinafter with respect to FIGS. 5-8.

[0055] In some embodiments, fixture **200** comprises approximately 6-20 posts, more preferably 8-18 posts, or more preferably 10-16 posts around its circumference, though any alternative number of posts may be provided. Likewise, fixture **200** preferably has a diameter of about 2-40 mm, more preferably 4-30 mm, or more preferably 6-20 mm, though any alternative diameter may be provided. The diameter of fixture **200** preferably is the diameter of the braid in its "at rest" configuration.

[0056] Fixture **200** can optionally further comprise circumferential grooves **206** to facilitate interweaving of a first section of wire underneath an adjacent section of wire. The fixture optionally also may comprise localized depressions or holes **208** in addition, or as an alternative, to grooves **206**. Depressions **208** may be provided at locations where wire segments cross to act as a visual guide for formation of anchor braid **30**, as well as to facilitate the interweaving of a first section of wire beneath an adjacent section of wire.

[0057] Referring now to FIGS. 4A-D, an illustrative method of using fixture **200** to fabricate braided anchors in accordance with the present invention is described. FIG. 4A provides a detail view of a proximal front side region of fixture **200** during formation of a braided anchor. FIG. 4B shows a detail backside view of a central section of the fixture. FIG. 4C shows a full-length frontside view of the fixture and FIG. 4D shows the completed braid. In FIG. 4, anchor braid **30** is formed from a single strand of wrapped and interwoven wire **W**. However, it should be understood that anchor braid **30** alternatively may be formed from multiple strands of wire.

[0058] As seen in FIG. 4A, formation of anchor braid **30** begins with wire **W** being routed from starting position **P** near the proximal end of fixture **200** past outer proximal posts **204a** and inner proximal posts **202a**. Wire **W** preferably is formed from a superelastic and/or shape-memory material, such as Nitinol. However, alternative wire materials may be utilized, including Cobalt-Chromium, Steel and combinations thereof, as well as additional materials that will be apparent to those of skill in the art.

[0059] After passing inner proximal posts **202a**, wire **W** encircles fixture **200** in a helical spiral while extending towards the distal posts, as seen in FIGS. 4B and 4C. The wire illustratively encircles fixture **200** a full 360° revolution plus one additional post. However, any alternative degree of winding may be provided (e.g., a full 360° plus 2 additional posts, a full 360° plus 3 additional posts, or a number of posts less than a full 360°). As will be apparent to those of skill in the art, altering the degree of winding will alter the expansion characteristics of the resultant braid in ways per se known.

[0060] At distal inner posts **202b**, wire **W** forms turn **Tu** and is rerouted back towards proximal inner posts **202a**. It should

be noted that wire **W** can form turn **Tu** in either inner posts **202** or outer posts **204**. Turn **Tu** forms a closed end of the braid. Additional sets of inner and outer posts are also contemplated. The wire once again encircles fixture **200** in a full 360° helical revolution plus one additional post before reaching the proximal inner posts and being rerouted back towards the distal inner posts. This process is repeated with the wire repetitively interwoven at crossing locations between the proximal and distal posts, e.g., via grooves **206** and/or depressions **208**, to define the cells of the braid that will provide anchor **30** with desired characteristics. As seen in FIG. 4D, wire **W** turns both proximally and distally in order to complete formation of the braid. In this embodiment, wire **W** terminates in the central portion of the braid at **T**. Termination **T** may be formed, for example, by welding the wires together, applying a shrink tube about the overlap, using a crimp, braising the wires, etc. Additional techniques will be apparent to those of skill in the art.

[0061] When anchor braid **30** is formed from a shape-memory material, the braid may be heat set such that it maintains a desired degree of expansion in an at-rest configuration. The heat set at-rest configuration may comprise, for example, the delivery configuration (e.g., collapsed configuration) of FIG. 2A, the deployed configuration (e.g., expanded configuration) of FIGS. 2B and 2C, or any desired configuration therebetween. In preferred embodiments, the anchor is heat set in a configuration between the delivery configuration and the deployed configuration. Anchor braid **30** may be heat set while still disposed on fixture **200** to maintain an at-rest configuration as formed on the fixture, which preferably is a configuration between the delivery and deployed configurations. Alternatively, the braid may be heat set after complete or partial removal from the fixture. As yet another alternative, the braid may be initially heat set while still disposed on the fixture, but thereafter may be additionally heat set in a different shape, for example, a more expanded configuration. It is expected that heat setting anchor braid **30** will provide the braid with desired delivery and/or deployment characteristics.

[0062] Referring now to FIGS. 5A-5O, in conjunction with FIGS. 2C and 4, an anchor braid **30** may be defined by a set of cells that is different than other cells. Such cells may be formed to provide anchor braid **30** with one or more edge features (for either or both the distal and proximal ends). These edge features can, for example, reduce or relieve stress within the braid during delivery and deployment, which in turn may reduce the incidence of anchor material fatigue caused by the pulsatile anchor motion of the anchor site. As will be apparent to those of skill in the art, forming braid **31** from a single strand of wire **W** (or from multiple strands of wire **W** that form turns or that are joined together) may lead to stress concentration at turns **Tu** in the wire where the wire changes direction and extends back towards the opposite end of the braid. Such stress concentration may be most pronounced while the braid is disposed in its extreme configurations, i.e. when the braid is disposed in the collapsed delivery configuration of FIG. 2A or the expanded deployed configuration of FIGS. 2B and 2C.

[0063] Stress concentration may increase the rigidity of an anchor braid and/or may impede delivery and deployment, as well as sheathing, of the braid. Thus, in preferred embodiments, a group of cells can be configured to reduce the sheathing force as described herein. Furthermore, to enhance deliverability, stress concentration may require that anchor braid

30 be fabricated from a relatively thin wire **W**. However, thin wire may not provide anchor braid **30** with adequate radial strength to displace a patient's diseased native heart valve leaflets and/or to anchor apparatus **10** against a patient's anatomy. Conversely, use of a relatively thick wire **W** may increase stiffness, thereby precluding retrograde delivery of apparatus **10**, as well as a risk of kinking at turns in the braid. Thus, in some embodiments, wires varying in thickness may be used, or multiple wires having different thickness may be woven together. Also, wires made from different materials may be used to form an anchor braid.

[0064] It may be desirable to reduce stress concentration at the edges of anchor **30** where wire **W** changes direction and/or to reduce the circumferential stiffness of the anchor braid. The edge characteristics of the anchor may be altered by altering the shape of substantially all anchor braid cells at the anchor's edge (e.g., distal edge and/or proximal edge). Wire turns that control the shape of the edge cells may be formed within anchor braid **30** by routing wire **W** around optional outer posts **204** of fixture **200** during formation of the braid. FIG. **5A** illustrates a detail view of a standard end turn **Tu** in an anchor braid resulting in a braid with substantially uniform cell size and shape. FIG. **5B** illustrates a turn that has been elongated to lengthen the distance over which forces concentrated in the turn may be distributed, resulting in an anchor braid having edge cells that are longer along the anchor axis than the other cells defined by the braid. This elongated turn feature may be formed by routing the wire of braid about outer posts **204** of fixture **200**, and then heat setting the wire.

[0065] FIG. **5C** illustrates an alternative anchor edge cell configuration, wherein the tip of the elongated wire turn has been bent out of a cylindrical shape defined by the braid of anchor braid **30**. This may be achieved, for example, via a combination of routing of wire **W** within fixture **200** and heat setting. The out-of-plane bend of turn **Tu** in the anchor edge cells in FIG. **5C** may reduce stress in some configurations, and may also provide a lip for engaging the patient's native valve leaflets to facilitate proper positioning of apparatus **10** during deployment.

[0066] In FIG. **5D**, a W-shaped turn feature has been formed at the wire turn, e.g., by routing the wire of anchor braid **30** about a central inner post **202** and two flanking outer posts **204** of fixture **200**. As with the elongated braid cells of FIGS. **5B** and **5C**, the W-shape may better distribute stress about turn **Tu**. The anchor edge cell configuration in FIG. **5E** includes a loop formed in braid **31** at the turn, which may be formed by looping wire **W** around an inner or outer post of fixture **200**. FIG. **5F** provides another alternative anchor edge cell configuration having a figure-eight shape. Such a shape may be formed, for example, by wrapping wire **W** about an inner post **202** and an aligned outer post **204** in a figure-eight fashion, and then heat setting the wire in the resultant shape.

[0067] In FIG. **5G**, the edge cells of braid **31** include a heart-shaped configuration, which may be formed by wrapping the wire about an aligned inner and outer post of fixture **200** in the desired manner. In FIG. **5H**, the edge cells of braid **31** have an asymmetric loop at turn **Tu**. The asymmetric loop will affect twisting of braid **31** during expansion and collapse of the braid, in addition to affecting stress concentration. In FIG. **5I**, the anchor edge cells have a double-looped turn configuration, e.g. via wrapping about two adjacent inner or outer posts of fixture **200**. Additional loops may also be employed. The double loop turn feature may be formed with

a smooth transition between the loops, as in FIG. **5J**, or may be heat set with a more discontinuous shape, as in FIG. **5K**.

[0068] FIG. **5K** illustrates that the edge cells of braid **31** may have multiple different configurations about the anchor's circumference. For example, the anchor edge cells shown in FIG. **5K** have extended length cells as in FIG. **5B** disposed adjacent to standard size edge cells, as in FIG. **5A**. The anchor edge cells of FIG. **5L** have an extended turn configuration having an extended loop. The anchor edge cells shown in FIG. **5M** have an alternative extended configuration with a specified heat set profile. Finally, the anchor edge cells shown in FIG. **5N** that overlap or are interwoven to be coupled to one another.

[0069] In preferred embodiments, the edge cells may be wrapped using wire, string, or sutures, at a location where the wire overlaps after an end turn as is illustrated in FIG. **5O**. This tied-end turn feature prevents cells from interlocking with each other during deployment.

[0070] The edge cell configuration of FIG. **5** may be heat set independently of the rest of the braid. The anchor edge cell configurations of FIG. **5** are provided only for the sake of illustration and should in no way be construed as limiting. Additional turn features within the scope of the present invention will appear to those of skill in the art in view of FIG. **5**. Furthermore, combinations of any such turn features may be provided to achieve desired characteristics of anchor braid **30**.

[0071] Referring now to FIGS. **6A-E**, additional configurations for reducing stress concentration and/or circumferential stiffness of anchor braid **30** are illustrated. Such configurations can be used independently or in conjunction with other configurations disclosed herein. Such configurations are preferably used at the anchor's edges to locally reduce the cross-sectional area of substantially all cells or all cells in the anchor braid's edge (e.g., proximal and/or distal). As seen in FIGS. **6A** and **6B**, turns **Tu** in wire **W** typically may have a substantially continuous (e.g., round) cross-sectional profile. As seen in FIG. **6C**, modifying the edge cell configuration by locally reducing the thickness or cross-sectional area of wire **W** at turn(s) **Tu** will reduce stress concentration within the wire at the turns and facilitate collapse and/or expansion of anchor braid **30** from the delivery to the deployed configurations. Furthermore, it is expected that such localized reduction in thickness or cross-sectional area will reduce a risk of kinking, fatigue or other failure at turns **Tu**.

[0072] Localized reduction may be achieved via a localized etching and/or electropolishing process. Alternatively or additionally, localized grinding of the turns may be utilized. Additional processing techniques will be apparent to those of skill in the art. As seen in FIGS. **6D-6E**, wire **W** may, for example, comprise an oval or rectangular cross-sectional profile, respectively, after localized reduction. The wire alternatively may comprise a round profile of reduced cross-sectional area (not shown). Additional profiles will be apparent. Localized reduction can take place at any time (e.g., before or after a braid is woven). Preferably, localized reduction occurs after weaving. However, in some embodiments, a wire of a given length may be etched or ground at preset segments and subsequently woven.

[0073] Referring now to FIGS. **7A-J**, instead of terminating the beginning and end of wire **W** of braid **31** at an overlap within the braid, as discussed previously, the two ends of the wire may be terminated at the anchor's edge. Likewise, when braid **31** is fabricated from multiple wires **W**, the wires (or a subset of the wires) optionally may be joined together or

terminated at turn(s) of the braid. In FIG. 7A, wire termination T at the ends of wire(s) W comprises a hinged termination with hinge post 38. In FIG. 7B termination T comprises a clipped or crimped termination with end cap 39. In FIG. 7C, cap 39 is wrapped about the ends of wire W to form wrapped termination T.

[0074] In FIG. 7D, cap 39 is placed over the wire ends, which are then bent to provide a swivel termination. In FIG. 7E, the wire ends are potted within cap 39 at termination T. In FIG. 7F, cap 39 is swaged about the wire ends. In FIG. 7G, the wire ends are welded or glued together. In FIG. 7G, the wire ends are spot welded together. Alternatively, the wire ends may be braised to form termination T, as in FIG. 7H. As yet another alternative, cap 39 may be placed about the wire ends, and kinks K may be formed in wire W to provide the ends of the wire with an 'over-center' bias that maintains termination T, e.g., swivel termination T. Additional terminations will be apparent to those of skill in the art.

[0075] With reference now to FIGS. 8A-B, alternative anchors of the present invention are described having anchor edge features that facilitate sheathing of the apparatus and reduce the sheathing force. In FIG. 8A, the edge cells of anchor 30 have inwardly canted configurations at the wire turns Tu about a proximal circumference of the anchor. These edge cell configurations provide the proximal circumference with a conical profile that facilitates sheathing of the apparatus within a delivery system, e.g., previously described delivery system 100, by allowing collapse of anchor 30 to proceed in a more gradual and/or continuous manner, and funneling the anchor into the sheath.

[0076] FIG. 8B illustrates another alternative anchor 30 having edge cell configurations formed by wire turns Tu about its proximal circumference that first cant outward, and then cant inward. The inward cant provides the proximal circumference with a conical profile and may facilitate sheathing, while the outward cant may facilitate anchoring at a treatment site, e.g., may engage a patient's native valve leaflets. As will be apparent, the edge cell configurations of FIG. 8, as well as those of FIGS. 5-7, optionally may be provided at either the proximal or distal ends of the anchor, or both. The edge cell configurations of FIG. 8, as well as those of FIGS. 5 and 7, may, for example, be formed by heat setting braid 31 in the desired configuration.

[0077] Referring now to FIG. 9, further alternative anchors are described having edge cell configurations adapted to lock the anchor in the deployed configuration to maintain expansion. In FIG. 9A, anchor 30 comprises elongated, hooked edge cells formed from wire turns Tu that are configured to snag braid 31 and maintain the anchor in the deployed configuration, as shown. In FIG. 9B, the hooked turn features have been elongated, such that the hooks are configured to snag the opposing end of anchor 30 to maintain expansion.

[0078] In FIG. 9C, anchor edge cells defined by wire turns TuP and distal turn features TuD are configured to interlock between the ends of anchor braid 30 in order to maintain the deployed configuration of anchor 30. The proximal edge cells form a hook adapted to engage elongated turns of the distal turn features. As will be apparent, the disposition of all or a portion of the proximal and distal edge cell configurations optionally may be reversed, i.e. the proximal edge cells may form hooks and the distal edge cells may be configured as elongated turns. FIG. 9D illustrates interlocking proximal and distal edge cell configurations of more complex geometry. FIG. 9E illustrates interlocking proximal and distal edge

cell configurations while anchor 30 is disposed in the collapsed delivery configuration. The locking turn features of FIG. 9 may, for example, be formed by heat setting anchor braid 30 (or locking features only) in the desired configuration. Additional locking turn features will be apparent to those of skill in the art. In preferred embodiments, the anchor locking mechanism can be set to have alternative locking options that allow for various amounts of expansion.

[0079] FIGS. 10A-10D illustrate various embodiments of anchor braids. An anchor braid can be made of one or more wire and can be used to form various density braids. The density of the braid can be assessed by the size of cells formed by the weave. In some embodiments, two or more different density braids may be woven together. For example, FIG. 10A illustrates two groups of cells or two braids interwoven in the center. The top group of cells forms a more open weave than the bottom group of cells, which forms a denser weave. FIG. 10B illustrates another embodiment of an anchor braid having three groups of cells. The top and bottom (proximal and distal) edges of the anchor braid have denser cells than the central portion of the anchor. Also, the edges of the anchor are woven from a thinner filament than the central portion. In another embodiment illustrated by FIG. 10C, all three sections of an anchor valve are woven by more than one wire. The wires of each section are made of a different material and/or thickness. Wires at the sectional boundaries may or may not interconnect with wires from a different section. Each of the sections of the braid anchor may be composed of a different number of wires. FIG. 10D illustrates another embodiment of a braided anchor having three sections. In this embodiment, all sections are composed of a single wire. The proximal and distal sections/edges of the braided anchor have the same pitch. The central region of the braided anchor has a different pitch than the edge sections.

[0080] FIGS. 11A-11E illustrate side views of braided anchor having more than one braid pitch. Varying pitch within the anchor allows localized variations in foreshortening across the anchor, as greater foreshortening is achieved by higher pitch of the braid. Moreover, the localized foreshortening features allow for the design of a braid which incorporates various diameters depending upon the amount of foreshortening. (The greater the foreshortening, the greater the diameter increase upon deployment.)

[0081] FIG. 11A, for example, is a side view representation of braided anchor of FIG. 10D. On the left side of the figure, the expanded anchor is illustrated having a denser weave (shorter pitch) at the distal and proximal ends; hence the dots are located closer to each other. The middle section of the anchor is composed of a looser weave that is generated by a higher pitch braid and is represented by dots that are farther away from each other. On the right side of the figure, the braided anchor is foreshortened and the dots are collapsed closer to each other. In this case, the central portion of the anchor foreshortened more than the proximal and distal edges. FIG. 11B illustrates a side view of a foreshortened braided anchor that is created by low pitch at the edges and high pitch in the middle. FIG. 11C illustrates a side view of a foreshortened braided anchor that is created by high pitch edges and low pitch middle section. FIG. 11D illustrates a side view of a foreshortened braided anchor that includes a sealing feature or space filling feature at both ends. This type of anchor can be created by a high pitch braid at edges, low pitch braid in the middle and heat setting the edges to curl upon unsheathing. This end feature is useful in facilitating

anchoring by functioning as a locator and sealing. FIG. 11E illustrates a side view of a foreshortened braided anchor that is associated with an everting valve or locational features.

[0082] In preferred embodiments, the middle section of the anchor may be composed of thicker wire(s) than edge section (s)

[0083] FIGS. 12A-12C illustrate an example of the process of deploying the anchor, such as the one illustrated in FIG. 11B above. FIG. 12A illustrates a braided anchor 30 in its expanded configuration. The anchor is composed of three sections. The distal and proximal sections of the anchor are made of a fine weave (low pitch) braid. The middle section of the anchor is made of a higher pitch braid and are preferably heat set to roll upon unsheathing. Furthermore, in preferred embodiments, the filaments of the distal and proximal sections may be thinner (e.g. 0.005 in thickness) than the filaments of the middle section (e.g., 0.010 in thickness). Posts 32 are coupled to the middle section of the anchor. For deployment, tubes 106 are coupled to the anchor's middle section. FIG. 12B illustrates the process of deployment. As the anchor is pushed distally by the tubes and pulled proximally by wires, it is unsheathed and begins foreshortening. The distal section rolls up and can act as a locator, assisting the operator in locating the aortic valve. It then functions as a seal preventing leakage. The proximal section may optionally also roll up. In FIG. 12C, the device may be configured such that the middle section of the valve may form an hour glass shape or a round shape. The tubes may subsequently be removed as described before. FIG. 12D is another illustration of the braided anchor in its elongated configuration. FIG. 12E is another illustration of the braided anchor in its foreshortened configuration.

[0084] FIGS. 13A-13B illustrate another embodiment of a braided anchor. In this embodiment, the anchor includes two sections--a distal section made of a fine weave and a higher pitch braid than the proximal section. In FIG. 13A the device is deployed such that the distal section made of the fine weave is distal to the aortic valve. In FIG. 13B, the distal section is foreshortened, either by heat set memory or actively. The foreshortening of the distal section allows the operator to locate the valve and situate the anchor prior to release.

[0085] The anchors described herein can be, for example, radially symmetrical, bilaterally symmetrical, or asymmetrical. A radially symmetrical anchor is one for which symmetry exists across any diameter. A bilaterally symmetrical anchor is one for which symmetry exists across a finite number of diameters. An asymmetrical anchor is one for which there exists no diameter across which a symmetry may be found. FIG. 2B illustrates one embodiment of a radially symmetrical anchor. FIG. 14A illustrates one embodiment of a bilaterally symmetrical anchor. FIG. 14B illustrates two embodiments (side and top views) of asymmetrical anchors. The benefits of bilaterally symmetrical an asymmetrical anchors is their ability to avoid interfering with anatomical features, such as, for example the coronary ostial and/or mitral valve. Thus, in preferred embodiments, a braided anchor includes a region adapted to prevent expansion of the anchor into the mitral valve, as is illustrated in FIG. 14A.

[0086] While preferred embodiments of the present invention are shown and described herein, it will be obvious to those skilled in the art that such embodiments are provided by

way of example only. Numerous variations, changes, and substitutions will occur to those skilled in the art without departing from the invention. It should be understood that various alternatives to the embodiments of the invention described herein may be employed in practicing the invention. It is intended that the following claims define the scope of the invention and that methods and structures within the scope of these claims and their equivalents be covered thereby.

What is claimed is:

1. A replacement heart valve assembly having an undeployed configuration and a deployed configuration, the assembly comprising:

- an anchor comprising a plurality of sections, including a distal section and a middle section, the middle section longitudinally offset from the distal section, wherein, when the assembly is in the undeployed configuration, the distal section and middle section are cylindrical and, when the assembly is in the deployed configuration, the distal section is at least partially everted; and
- a replacement valve, the replacement valve disposed within at least a portion of the middle section when the assembly is in the deployed configuration.

2. The replacement heart valve assembly of claim 1 further comprising a proximal section, the proximal section longitudinally offset from the middle section, wherein, when the assembly is in the deployed configuration, at least a portion of the proximal section is everted.

3. The replacement heart valve assembly of claim 1, wherein the middle section and distal section are formed from at least one braided wire.

4. The replacement heart valve assembly of claim 3, wherein the middle section has a higher braid density than the distal section.

5. The replacement heart valve assembly of claim 3, wherein the distal section has a higher braid density than the middle section.

6. The replacement heart valve assembly of claim 3, wherein the at least one braided wire of the distal section is thinner than the at least one braided wire of the middle section.

7. The replacement heart valve assembly of claim 1 further comprising a plurality of posts coupled to the middle section.

8. The replacement heart valve assembly of claim 1, wherein the replacement valve has three valve leaflets.

9. The replacement heart valve assembly of claim 8 further comprising a plurality of posts coupled to the middle section, the leaflets attached to the posts.

10. The replacement heart valve assembly of claim 9, wherein, when the assembly is in the deployed configuration, the anchor is shorter than when the assembly is in the undeployed configuration.

11. The replacement heart valve assembly of claim 1, wherein the anchor is formed from a shape-memory material.

12. The replacement heart valve assembly of claim 1, wherein, when the assembly is in the deployed configuration, at least a portion of the distal section is rolled.

13. The replacement heart valve assembly of claim 1, wherein wire material forming the distal section is different than the wire material forming the middle section.

* * * * *