



US00D404970S

United States Patent [19]
Asberg

[11] **Patent Number:** **Des. 404,970**
[45] **Date of Patent:** ****Feb. 2, 1999**

[54] **BEVERAGE CONTAINER**
[75] Inventor: **Frédérique Asberg**, Am Amsterdam,
Netherlands
[73] Assignee: **Heineken Technical Services, B.V.**,
Netherlands
[**] Term: **14 Years**

D. 317,120 5/1991 Schwartzburg .
D. 332,551 1/1993 Fields et al. .
D. 353,973 1/1995 Adado .
D. 360,114 7/1995 Whiteside, Jr. .
D. 379,589 6/1997 Rhodes et al. D9/500
2,895,636 7/1959 Martin 220/574
5,279,442 1/1994 Jentzsch et al. .
5,518,143 5/1996 Iodice .

[21] Appl. No.: **77,003**
[22] Filed: **Jul. 9, 1997**

OTHER PUBLICATIONS

The Canmaker, p. 110 (May 1995).
Glass #8852, 1207 Monogah GGlass Co. Apr. 1970.
Glasses(top, right) Tableware International Sep. 1974, p. 31.
Highball Glass, The New Yorker Magazine, Oct. 1951, p. 92.

Related U.S. Application Data

[62] Division of Ser. No. 39,900, Jun. 7, 1995, Pat. No. Des. 383,037.
[51] **LOC (6) Cl.** **07-01**
[52] **U.S. Cl.** **D7/511; D7/523; D7/504**
[58] **Field of Search** D7/529, 527, 524,
D7/528, 518, 515, 510, 511, 509, 507,
523, 562, 561, 531, 530, 533, 534, 535,
619; D9/503, 500, 504, 538, 506, 548,
539, 552; 215/392, 393, 391, 574

Primary Examiner—M. N. Pandozzi
Attorney, Agent, or Firm—Merchant, Gould, Smith, Edell,
Welter & Schmidt, P.A.

[56] **References Cited**

U.S. PATENT DOCUMENTS

D. 38,248 9/1906 Helmer .
D. 67,869 7/1925 Boswell .
D. 99,508 5/1936 Hutchinson .
D. 138,637 8/1944 Erbe .
D. 138,639 8/1944 Erbe .
D. 217,826 6/1970 Benes D7/523
D. 224,640 8/1972 Mascia et al. D9/506
D. 231,727 6/1974 Hasegana .
D. 249,111 8/1978 Geyer .

[57] **CLAIM**

The ornamental design for a beverage container, as shown and described.

DESCRIPTION

FIG. 1 is a top perspective view of a beverage container showing my new design;
FIG. 2 is a front elevational view thereof;
FIG. 3 is a top plan view thereof;
FIG. 4 is a bottom plan view thereof;
FIG. 5 is a top perspective view of a beverage container showing a second embodiment of my new design;
FIG. 6 is a front elevational view thereof;
FIG. 7 is a top plan view thereof; and,
FIG. 8 is a bottom plan view thereof.

1 Claim, 2 Drawing Sheets

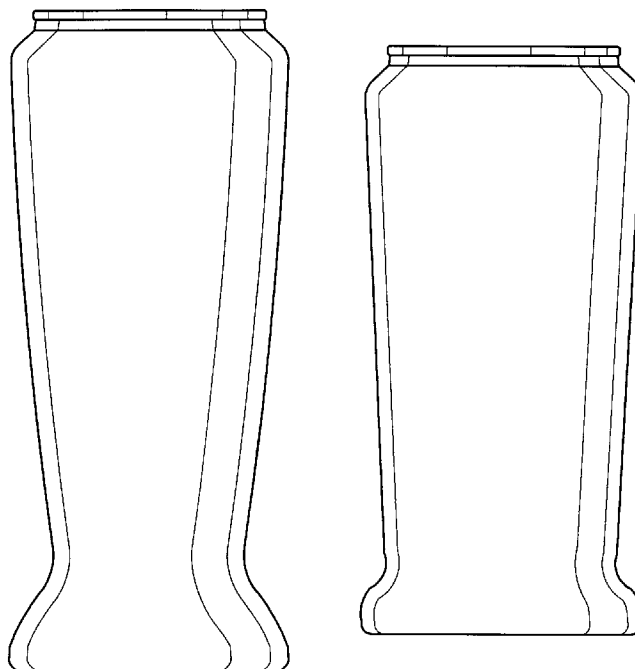

FIG. 3

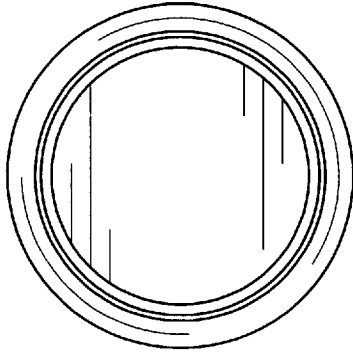

FIG. 4

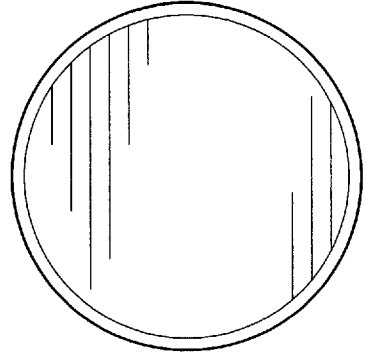

FIG. 2

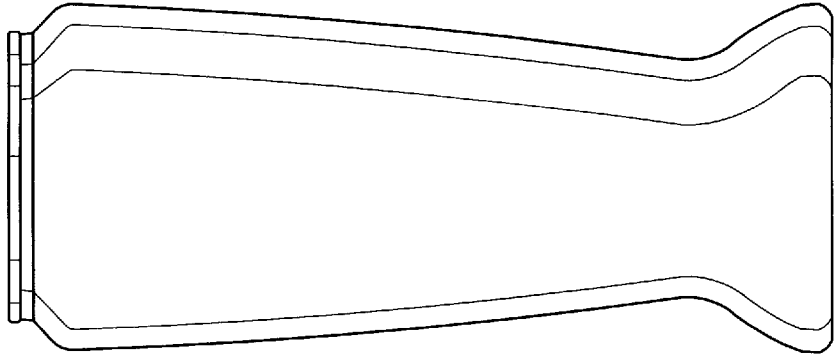

FIG. 1

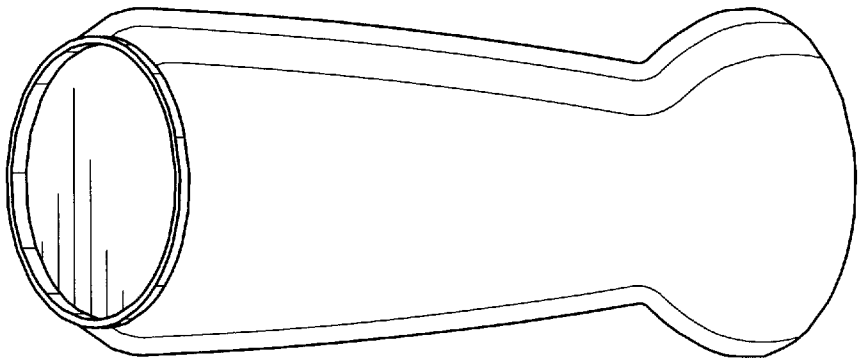

FIG. 5

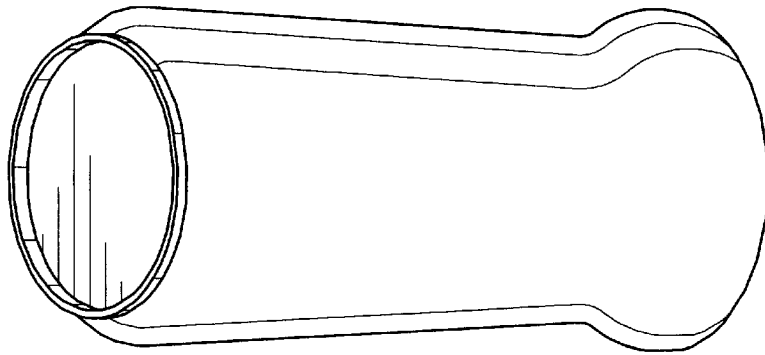

FIG. 6

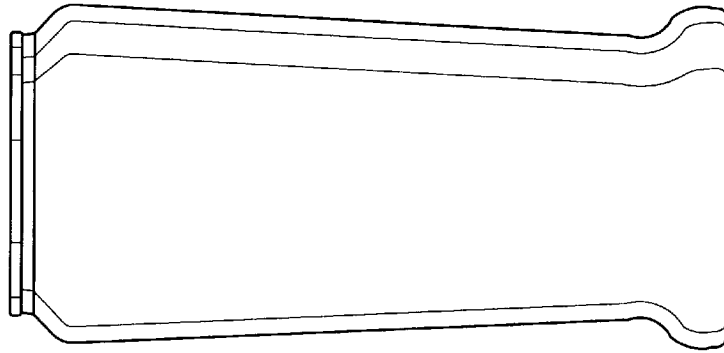

FIG. 7

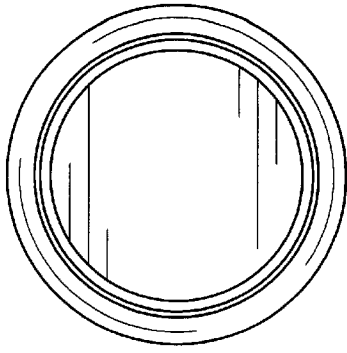
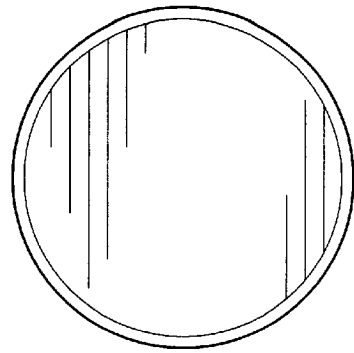

FIG. 8



UNITED STATES PATENT AND TRADEMARK OFFICE
CERTIFICATE OF CORRECTION

PATENT NO. : D 404,970
DATED : February 2, 1999
INVENTOR(S) : Asberg

It is certified that error appears in the above-identified patent and that said Letters Patent is hereby corrected as shown below:

On the title page, item[30] insert the following:

Foreign Application Priority Data

Dec. 7, 1994 [NL] Netherlands DMA 002720

Signed and Sealed this
Eighth Day of June, 1999

Attest:



Q. TODD DICKINSON

Attesting Officer

Acting Commissioner of Patents and Trademarks