



US00D623294S

(12) **United States Design Patent**
Rhoades et al.

(10) **Patent No.:** **US D623,294 S**

(45) **Date of Patent:** **** Sep. 7, 2010**

(54) **HANDHELD SKIN CARE TOOL**

(75) Inventors: **Dean Rhoades**, Beverly Hills, CA (US);
Robert Radi, Los Angeles, CA (US);
Kimber Maderazzo, Pacific Palisades,
CA (US)

(73) Assignee: **Guthy-Renker LLC**, Santa Monica, CA
(US)

(**) Term: **14 Years**

(21) Appl. No.: **29/346,589**

(22) Filed: **Nov. 3, 2009**

Related U.S. Application Data

(63) Continuation-in-part of application No. 29/289,072,
filed on Jul. 5, 2007, now Pat. No. Des. 608,002.

(51) **LOC (9) Cl.** **24-02**

(52) **U.S. Cl.** **D24/146; D24/133; D24/147**

(58) **Field of Classification Search** D24/133,
D24/146-147, 200, 214, 215; D28/57-59,
D28/62; 132/75.6, 76.4; 606/85, 131-133
See application file for complete search history.

(56) **References Cited**

U.S. PATENT DOCUMENTS

D226,043	S	*	1/1973	Wolff	D24/214
D269,377	S	*	6/1983	Mackay et al.	D24/214
D414,582	S	*	9/1999	Hwang	D24/214
6,312,397	B1	*	11/2001	Gebhard	601/15
6,652,888	B2	*	11/2003	Rhoades	606/131
D500,854	S	*	1/2005	Eichel	D24/146
D510,138	S	*	9/2005	Kim	D24/133

D533,943	S	*	12/2006	Chen	D24/146
D550,842	S	*	9/2007	Koch et al.	D24/146
D561,343	S	*	2/2008	Liang	D24/215
7,572,238	B2	*	8/2009	Rhoades	601/73
D608,002	S	*	1/2010	Rhoades et al.	D24/146

* cited by examiner

Primary Examiner—Ian Simmons

Assistant Examiner—Wan Laymon

(74) *Attorney, Agent, or Firm*—Cislo & Thomas, LLP

(57) **CLAIM**

The ornamental design for a handheld skin care tool, as shown and described.

DESCRIPTION

FIG. 1 is a perspective view of the handheld skin care tool;

FIG. 2 is a top view of the handheld skin care tool shown in FIG. 1;

FIG. 3 is a bottom view of the handheld skin care tool shown in FIG. 1;

FIG. 4 is a front view of the handheld skin care tool shown in FIG. 1;

FIG. 5 is a right side view of the handheld skin care tool shown in FIG. 1;

FIG. 6 is left side view of the handheld skin care tool shown in FIG. 1; and,

FIG. 7 is a rear view of the handheld skin care tool shown in FIG. 1.

The broken line portions of the disclosure are included for the purpose of illustrating environment and form no part of the claimed design.

1 Claim, 4 Drawing Sheets

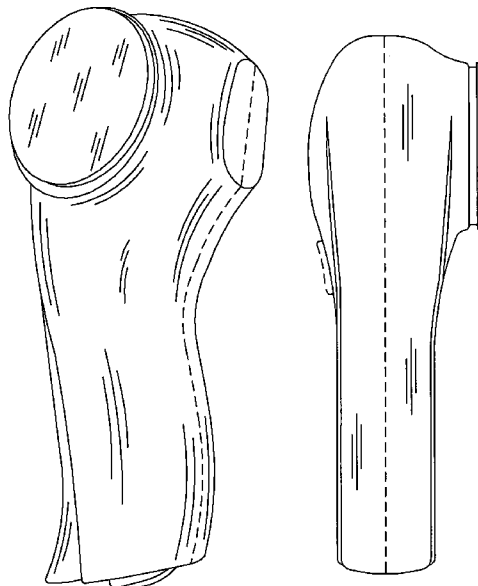

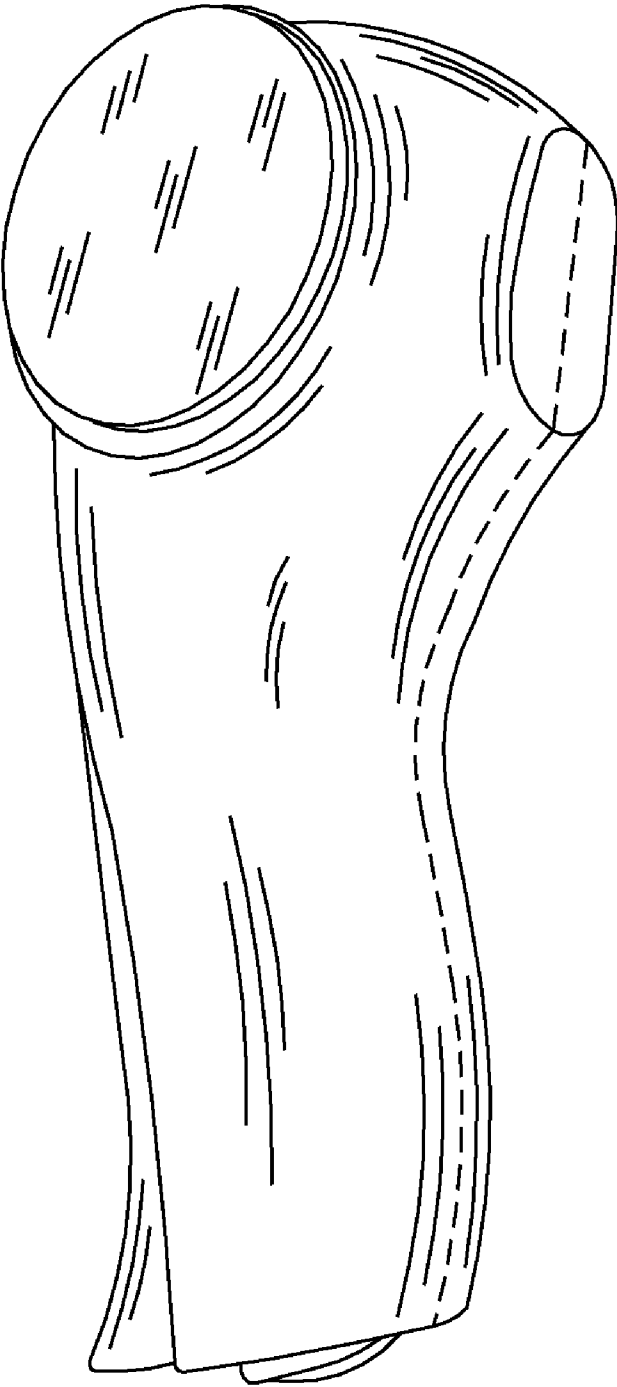

FIG. 1

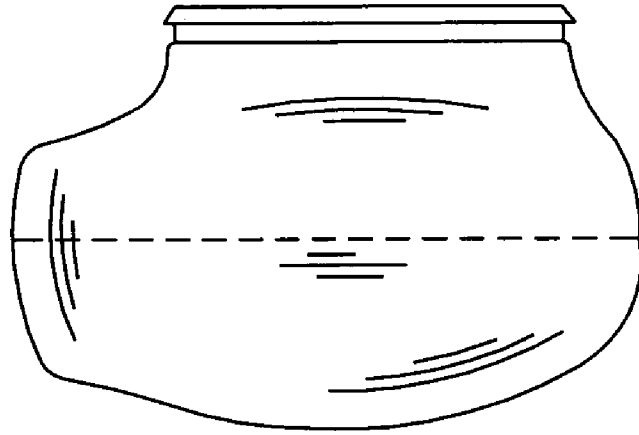

FIG. 2

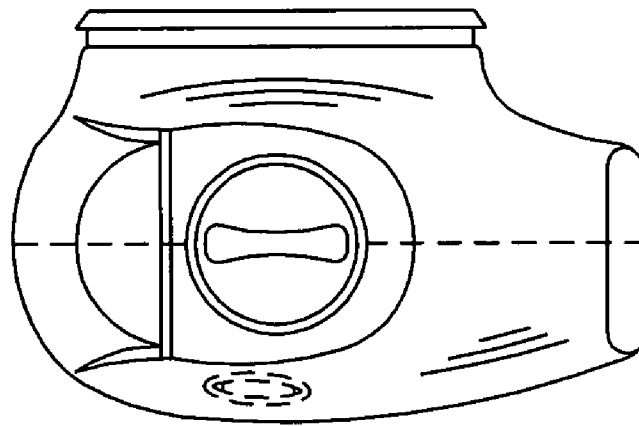

FIG. 3

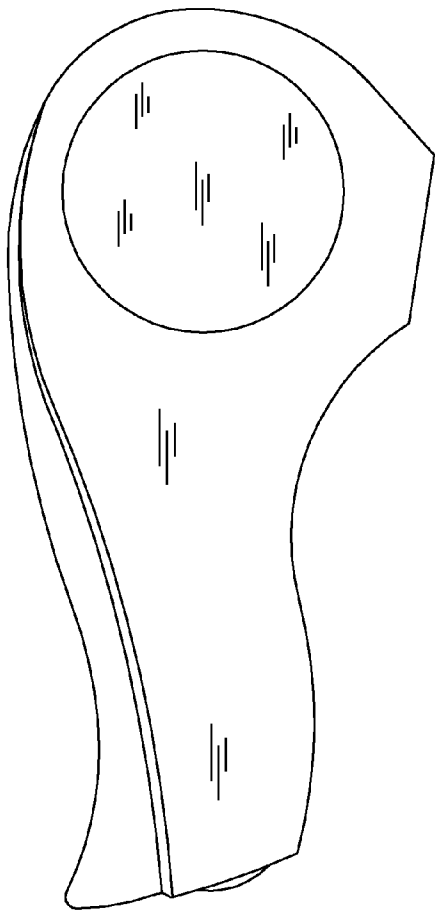

FIG. 4

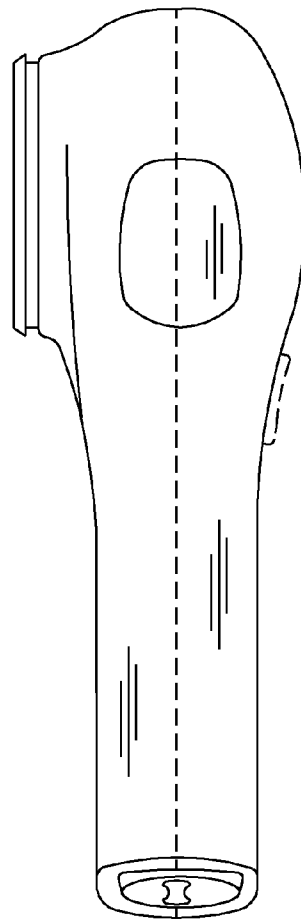

FIG. 5

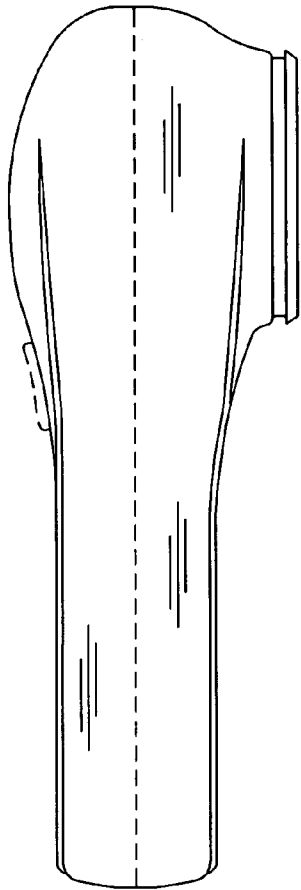

FIG. 6

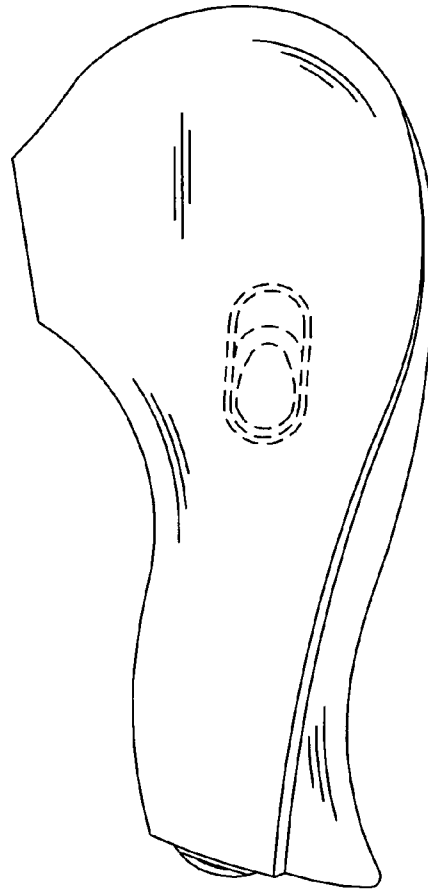

FIG. 7