



(12) **United States Design Patent**
Dulude et al.

(10) **Patent No.:** **US D920,587 S**
(45) **Date of Patent:** **** May 25, 2021**

(54) **EXTERNAL METATARSAL GUARD**

(74) *Attorney, Agent, or Firm* — Lerner, David, Littenberg, Krumholz & Mentlik, LLP

(71) Applicant: **TBL Licensing LLC**, Stratham, NH (US)

(57) **CLAIM**

(72) Inventors: **Ryan Dulude**, Lee, NH (US); **Stephen Douglas Ammon**, Hampton, NH (US); **Emily V. Miller**, Eliot, ME (US)

The ornamental design for an external metatarsal guard, as shown and described.

(73) Assignee: **TBL Licensing LLC**, Stratham, NH (US)

DESCRIPTION

(**) Term: **15 Years**

The present application is filed along with U.S. Design patent application Ser. No. 29/721,035, entitled Internal Metatarsal Guard and U.S. Design application Ser. No. 29/721,097, entitled External Metatarsal Guard, the disclosures of which are incorporated herein by reference.

(21) Appl. No.: **29/721,053**

FIG. 1 is a perspective view of an external metatarsal guard according to a first embodiment of the design;

(22) Filed: **Jan. 17, 2020**

FIG. 2 is a top view of an external metatarsal guard of the embodiment of FIG. 1;

(51) **LOC (13) Cl.** **24-02**

FIG. 3 is a bottom view of an external metatarsal guard of the embodiment of FIG. 1;

(52) **U.S. Cl.**
USPC **D29/121.2**

FIG. 4 is a left view of an external metatarsal guard of the embodiment of FIG. 1;

(58) **Field of Classification Search**
USPC D29/113, 114, 115, 120.1, 120.2, 121.1, 121.2, 122; D24/192; D2/909, 946
(Continued)

FIG. 5 is a right view of an external metatarsal guard of the embodiment of FIG. 1;

(56) **References Cited**

U.S. PATENT DOCUMENTS

FIG. 6 is a rear view of an external metatarsal guard of the embodiment of FIG. 1;

1,184,013 A 5/1916 Pierce
RE24,897 E * 11/1960 Schlecht A43B 7/32
36/72 R

FIG. 7 is a front view of an external metatarsal guard of the embodiment of FIG. 1;

(Continued)

FIG. 8 is a perspective view of an external metatarsal guard according to a second embodiment of the design;

OTHER PUBLICATIONS

Timberland PRO6 Millworks A1VWT Composite Toe External Met Guard Work Boot (on-line), no date available. Retrieved from Internet Aug. 7, 2020, URL: thebootdepot.com/mens/timberland-pro-6-millworks-a1vwt-composite-toe-external-met-guard-work-boot/ (1 page).*

FIG. 9 is a top view of an external metatarsal guard of the embodiment of FIG. 8;

(Continued)

FIG. 10 is a bottom view of an external metatarsal guard of the embodiment of FIG. 8;

Primary Examiner — Kimberly Barnes

FIG. 11 is a left view of an external metatarsal guard of the embodiment of FIG. 8;

(Continued)

FIG. 12 is a right view of an external metatarsal guard of the embodiment of FIG. 8;

FIG. 13 is a rear view of an external metatarsal guard of the embodiment of FIG. 8; and,

FIG. 14 is a front view of an external metatarsal guard of the embodiment of FIG. 8.

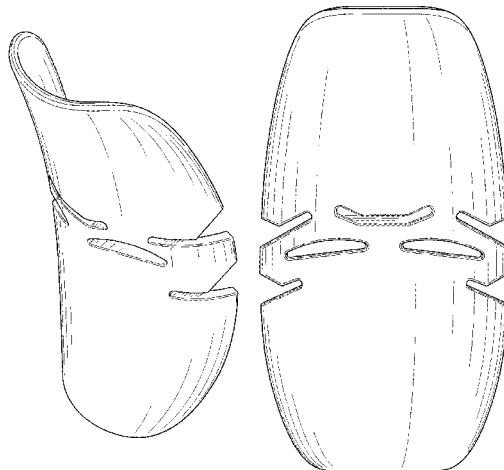

The broken lines depict portions of the external metatarsal guard that form no part of the claimed design.

1 Claim, 8 Drawing Sheets

(58) **Field of Classification Search**

CPC A41D 13/00; A41D 13/06; A41D 13/015;
 A41D 13/0543; A63B 71/08; A63B
 71/1225; A63B 2071/1283; A43C 13/00;
 A43C 13/14; A43B 7/22; A43B 7/32;
 A43B 23/0215; A43B 23/0235; A43B
 23/027; A43B 23/0275; A43B 23/028;
 A43B 23/042; A43B 23/17; A43B 3/163;
 A43B 7/18; A43B 23/26; A61F 5/14
 See application file for complete search history.

(56) **References Cited**

U.S. PATENT DOCUMENTS

3,082,553 A * 3/1963 Wilmanns A43C 13/14
 36/72 R
 3,206,874 A * 9/1965 Ellis A43B 23/082
 36/72 R
 3,465,365 A 9/1969 Jones
 4,972,609 A 11/1990 Oh et al.
 5,158,767 A * 10/1992 Cohen A43B 5/0407
 36/114
 5,457,898 A * 10/1995 Fortin A43C 13/14
 36/72 R
 D379,678 S 6/1997 Rosado
 5,680,657 A 10/1997 Valtakari
 5,833,639 A * 11/1998 Nunes A61F 5/0111
 602/23
 D418,967 S * 1/2000 Stengel D2/946
 D422,128 S 4/2000 Adler
 6,161,313 A 12/2000 Bisson
 D438,972 S 3/2001 Darby
 D446,000 S 8/2001 Price
 D453,861 S * 2/2002 Yake D29/121.2
 6,389,715 B1 * 5/2002 Krajcir A43B 7/32
 36/72 R
 D464,475 S 10/2002 Isackson et al.
 6,631,569 B1 10/2003 Scharbius et al.
 D507,402 S 7/2005 Laberge
 D555,291 S 11/2007 Danzo
 7,305,776 B2 * 12/2007 Hess A43B 7/32
 36/72 R

7,328,526 B2 2/2008 Peterson
 D594,161 S * 6/2009 Worden D29/121.1
 D608,007 S 1/2010 Arbesman et al.
 D614,853 S 5/2010 Warren et al.
 D622,057 S 8/2010 Warren et al.
 D625,502 S 10/2010 Brambilla
 D638,995 S 5/2011 Hanlon
 D665,539 S 8/2012 Manalo et al.
 D681,831 S 5/2013 Samlaska
 D696,499 S 12/2013 Lehtinen
 8,635,789 B2 * 1/2014 Spiller A43B 23/26
 36/72 R
 8,661,712 B2 * 3/2014 Aveni A43B 23/26
 36/54
 D714,530 S 10/2014 Scholler et al.
 D736,685 S 8/2015 Darwin
 D770,586 S * 11/2016 Sopol D21/772
 D783,845 S * 4/2017 Peluso D24/190
 D793,073 S 8/2017 Hardman
 9,744,065 B2 * 8/2017 Walborn A61F 5/0102
 9,788,609 B2 10/2017 James et al.
 D805,274 S 12/2017 Maxie
 D808,029 S 1/2018 Jimenez et al.
 9,867,431 B2 * 1/2018 Harley A43B 23/26
 D821,654 S * 6/2018 Roby D29/120.1
 D838,455 S 1/2019 Strother
 10,219,582 B2 3/2019 Spiller et al.
 D858,049 S 9/2019 Matsuo
 10,512,303 B2 12/2019 Ramsay et al.
 D876,018 S 2/2020 Dulude et al.
 2002/0104174 A1 * 8/2002 Bartlett A43B 7/32
 12/145
 2008/0115387 A1 5/2008 Walworth et al.
 2013/0081308 A1 4/2013 Woods
 2014/0259773 A1 * 9/2014 Johnson A43B 7/34
 36/96
 2018/0042337 A1 2/2018 Davis
 2019/0297988 A1 10/2019 Oden et al.
 2019/0350307 A1 * 11/2019 Bergeron A43B 7/18
 2019/0387811 A1 * 12/2019 Gibson A41B 11/007
 2020/0121028 A1 4/2020 Dulude

OTHER PUBLICATIONS

Reebok internal view, Jun. 15, 2018, 4 pages.
 Product, Reebok Beamer men's sneaker [online] [retrieved Mar. 21, 2019] Retrieved from the Internet: URL: <http://reebokwork.com/338/Reebok-Beamer-RB1067>, date not known, 4 pages.
 Extended European Search Report for Application No. EP19204000.4, dated Feb. 21, 2020, pp. 1-3.

* cited by examiner

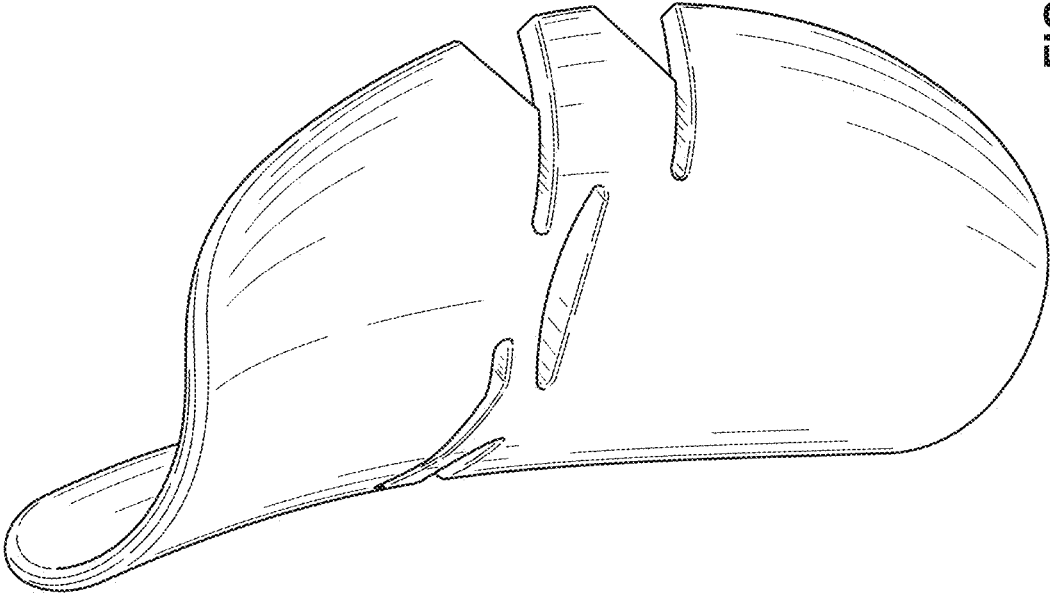

FIG. 1

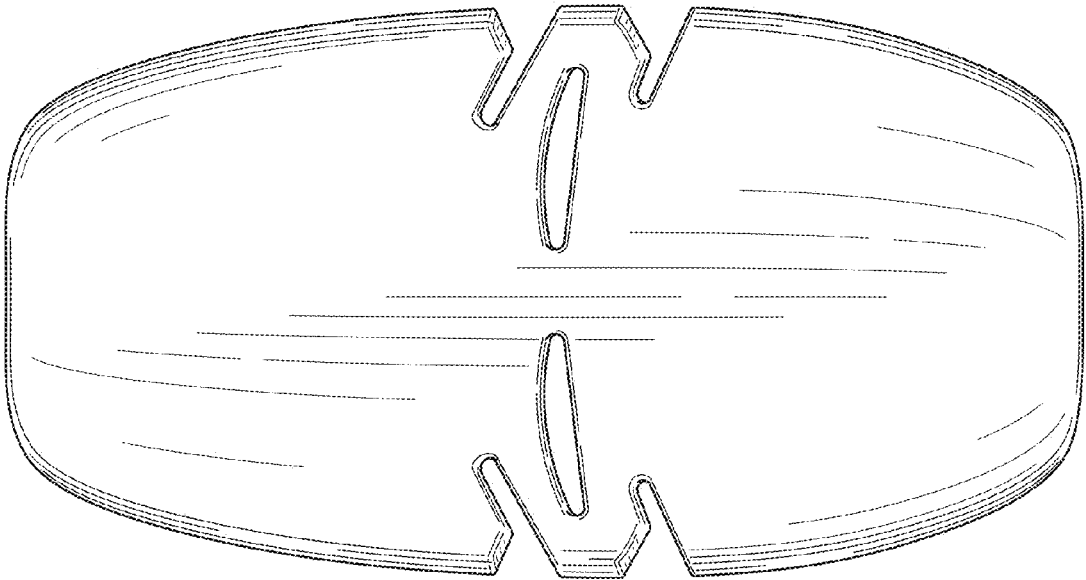

FIG. 3

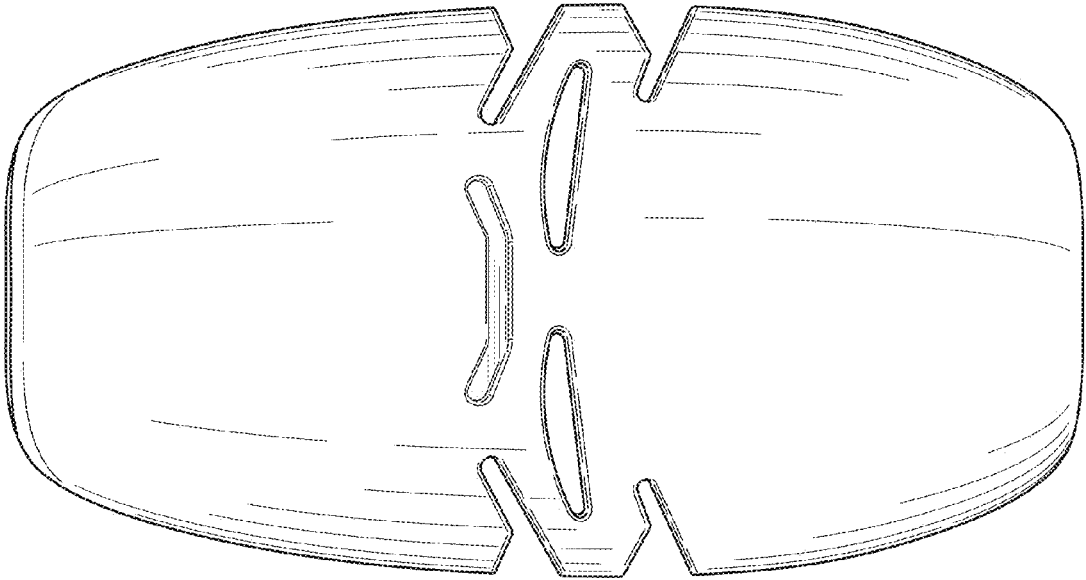

FIG. 2

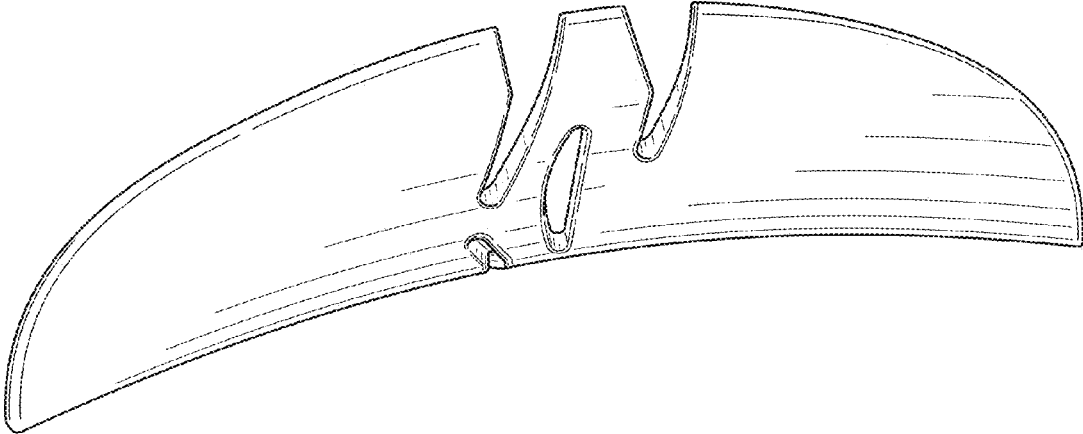

FIG. 5

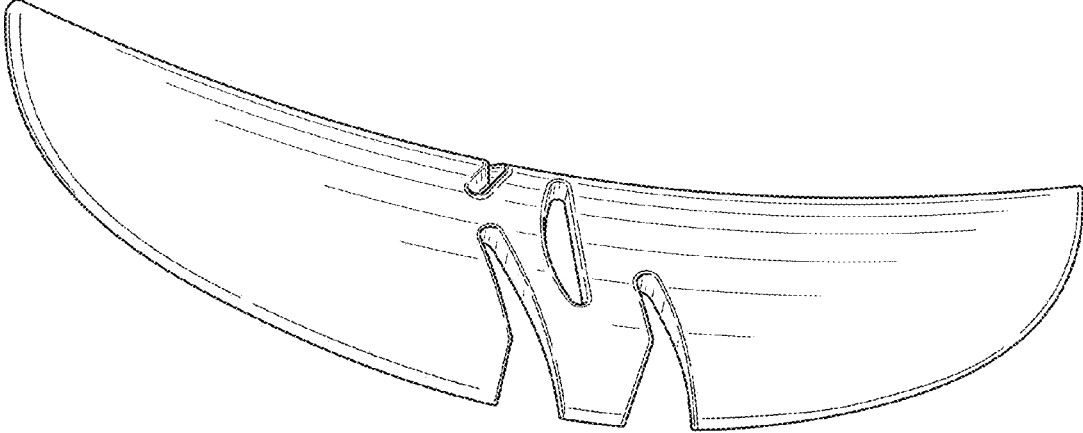

FIG. 4

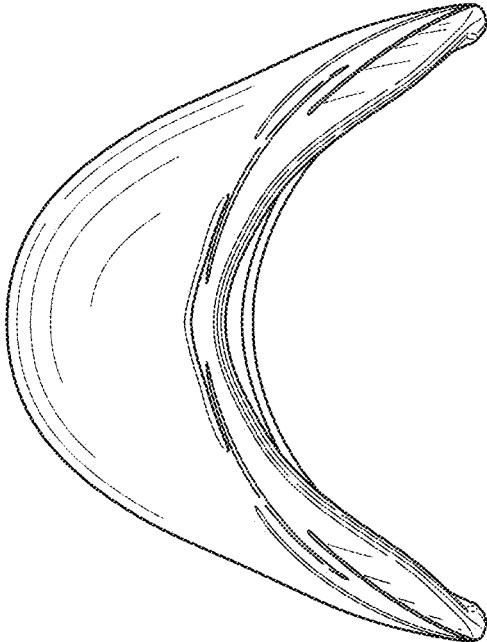

FIG. 7

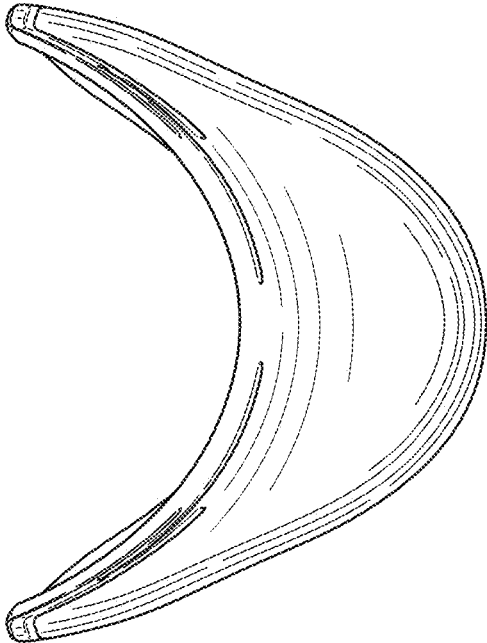

FIG. 6

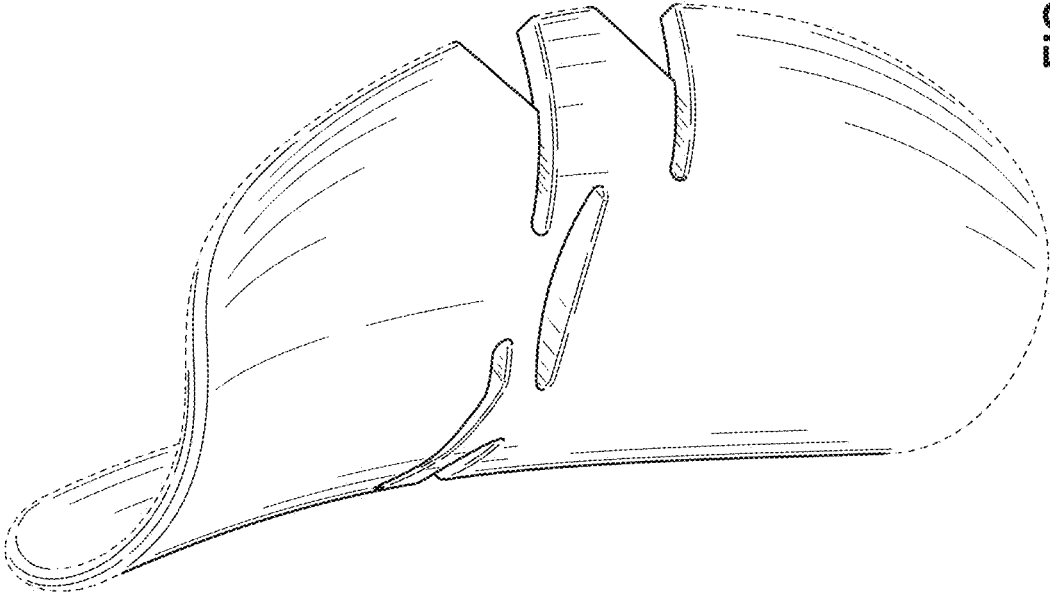

FIG. 8

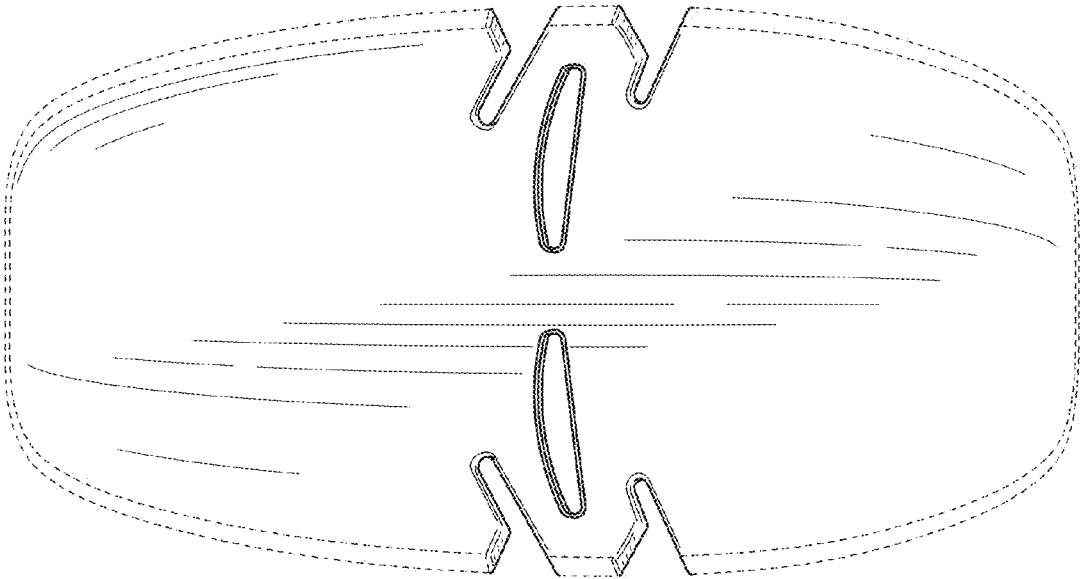

FIG. 10

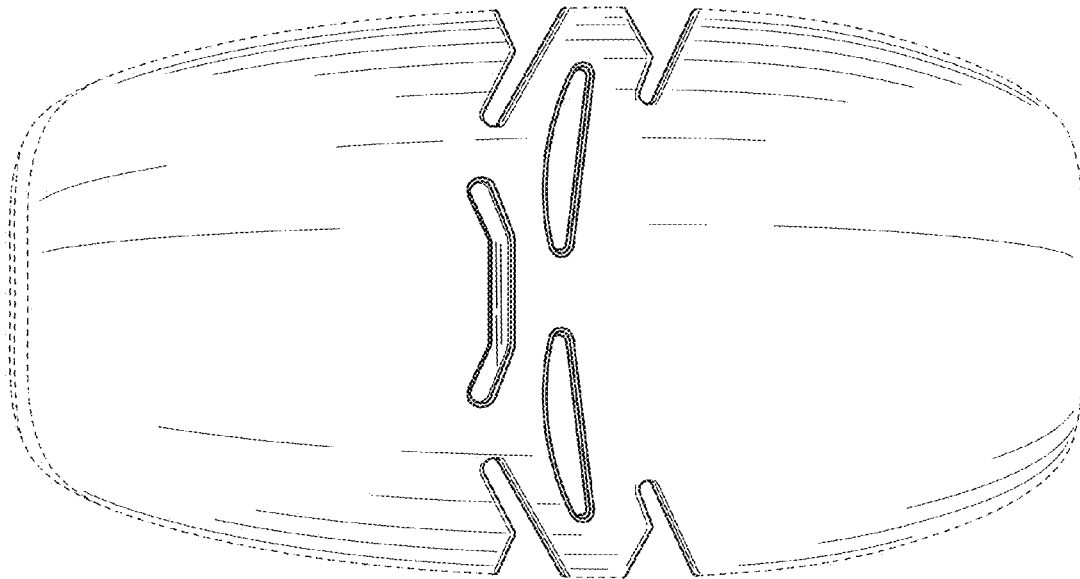

FIG. 9

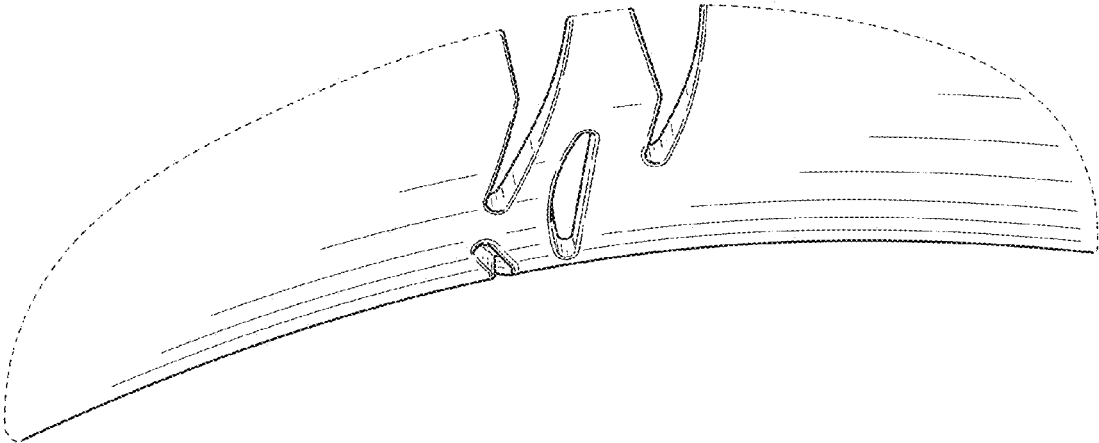

FIG. 11

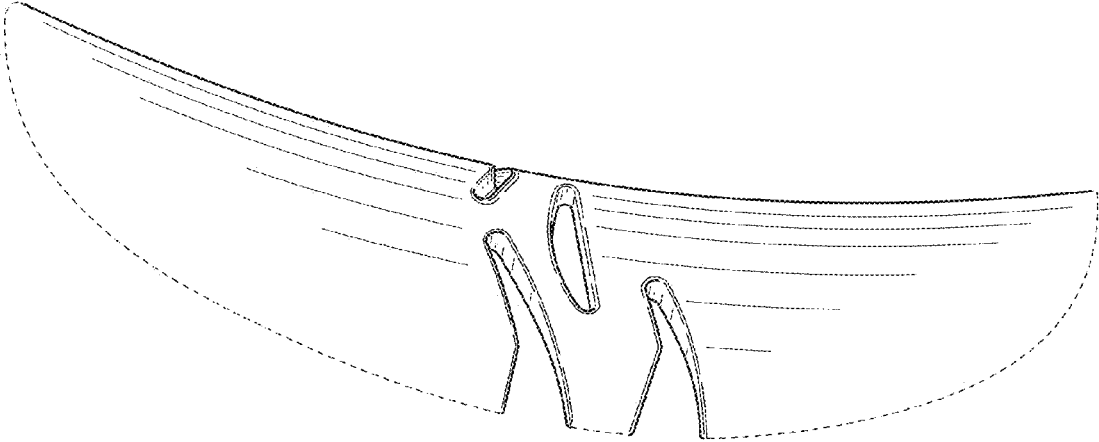

FIG. 12

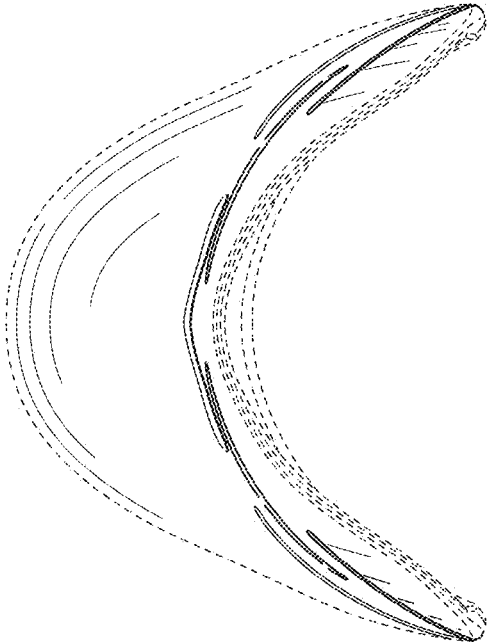

FIG. 14

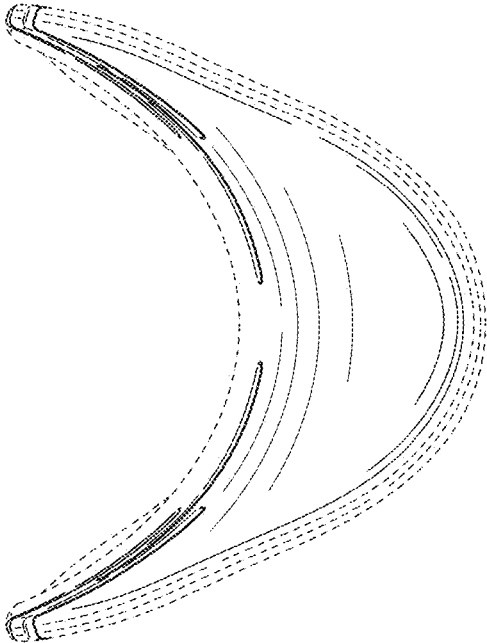

FIG. 13