



US00D656164S

(12) **United States Design Patent**
Nilsson

(10) **Patent No.:** **US D656,164 S**

(45) **Date of Patent:** **** Mar. 20, 2012**

(54) **FRONT LOADER ASSEMBLY**

(75) Inventor: **Tommy Nilsson, Umeå (SE)**

(73) Assignee: **Alo Aktiebolag, Umea (SE)**

(**) Term: **14 Years**

(21) Appl. No.: **29/371,770**

(22) Filed: **Sep. 12, 2011**

Related U.S. Application Data

(63) Continuation of application No. 29/371,684, filed on Jul. 7, 2011.

(51) **LOC (9) Cl.** **15-03**

(52) **U.S. Cl.** **D15/32; D15/28**

(58) **Field of Classification Search** D15/10,
D15/22-26, 28, 29, 32; 414/686, 694, 722,
414/718, 815, 723, 685, 724; 37/341, 407,
37/468; 212/347

See application file for complete search history.

(56) **References Cited**

U.S. PATENT DOCUMENTS

2,989,199	A *	6/1961	Hough et al.	414/706
4,576,543	A *	3/1986	Kuchyt et al.	414/722
D410,240	S *	5/1999	Sasaki	D15/32
D451,105	S *	11/2001	Masumoto et al.	D15/28
D459,368	S *	6/2002	Westendorf et al.	D15/32
D469,448	S *	1/2003	Bares et al.	D15/32
D507,004	S *	7/2005	Westendorf et al.	D15/32
D518,075	S *	3/2006	Westendorf et al.	D15/32
D528,569	S *	9/2006	Nilsson	D15/32
D529,053	S *	9/2006	Stender et al.	D15/32
D533,883	S *	12/2006	Higashikawa et al.	D15/32
7,281,890	B2 *	10/2007	Friesen et al.	414/686
D562,351	S *	2/2008	Higashikawa	D15/28
7,451,587	B2 *	11/2008	Komiya et al.	56/17.1
D584,749	S *	1/2009	Smith et al.	D15/28
D595,746	S *	7/2009	Iida et al.	D15/32
D598,031	S *	8/2009	Smith et al.	D15/28
D610,172	S *	2/2010	Yukino et al.	D15/32
D628,604	S *	12/2010	Major	D15/32
D646,306	S *	10/2011	Bradley et al.	D15/32

2003/0118432	A1 *	6/2003	Lee	414/722
2004/0161325	A1 *	8/2004	Yoshii et al.	414/686
2004/0228717	A1 *	11/2004	Perrin et al.	414/723
2006/0073003	A1 *	4/2006	Fukudome et al.	414/686
2006/0182592	A1 *	8/2006	Stender et al.	414/686
2006/0245899	A1 *	11/2006	Lyons et al.	414/686
2007/0020078	A1 *	1/2007	Frey	414/686
2007/0031233	A1 *	2/2007	Frey	414/685
2007/0217899	A1 *	9/2007	Sakada	414/722
2007/0243052	A1 *	10/2007	Fukudome et al.	414/723
2007/0292255	A1 *	12/2007	Nilsson	414/686
2008/0063502	A1 *	3/2008	Nilsson	414/685
2008/0193269	A1 *	8/2008	Sakada et al.	414/722

OTHER PUBLICATIONS

Certificate of Registration No. 000238670-0001 issued Jan. 25, 2005 by the Office for Harmonization in the Internal Market (Trade Marks and Designs).

Certificate of Registration No. 000238670-0002 issued Jan. 25, 2005 by the Office for Harmonization in the Internal Market (Trade Marks and Designs). Certificate of Registration No. 000238670-0003 issued Jan. 25, 2005 by the Office for Harmonization in the Internal Market (Trade Marks and Designs).

* cited by examiner

Primary Examiner — Mark Goodwin

(74) *Attorney, Agent, or Firm* — Harness, Dickey & Pierce, PLC

(57) **CLAIM**

The ornamental design for a front loader assembly, as shown and described.

DESCRIPTION

FIG. 1 is a bottom right side isometric view of a front loader assembly showing my new design;
FIG. 2 is a bottom left side isometric view thereof;
FIG. 3 is a front view thereof;
FIG. 4 is a rear view thereof;
FIG. 5 is a right side view thereof;
FIG. 6 is a top view thereof; and,
FIG. 7 is a bottom view thereof.

1 Claim, 2 Drawing Sheets

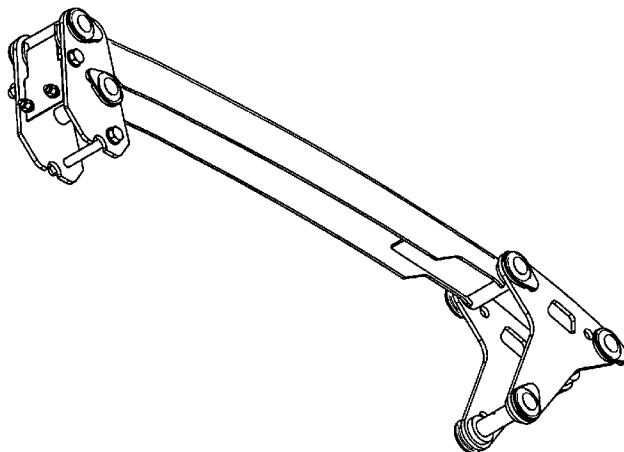

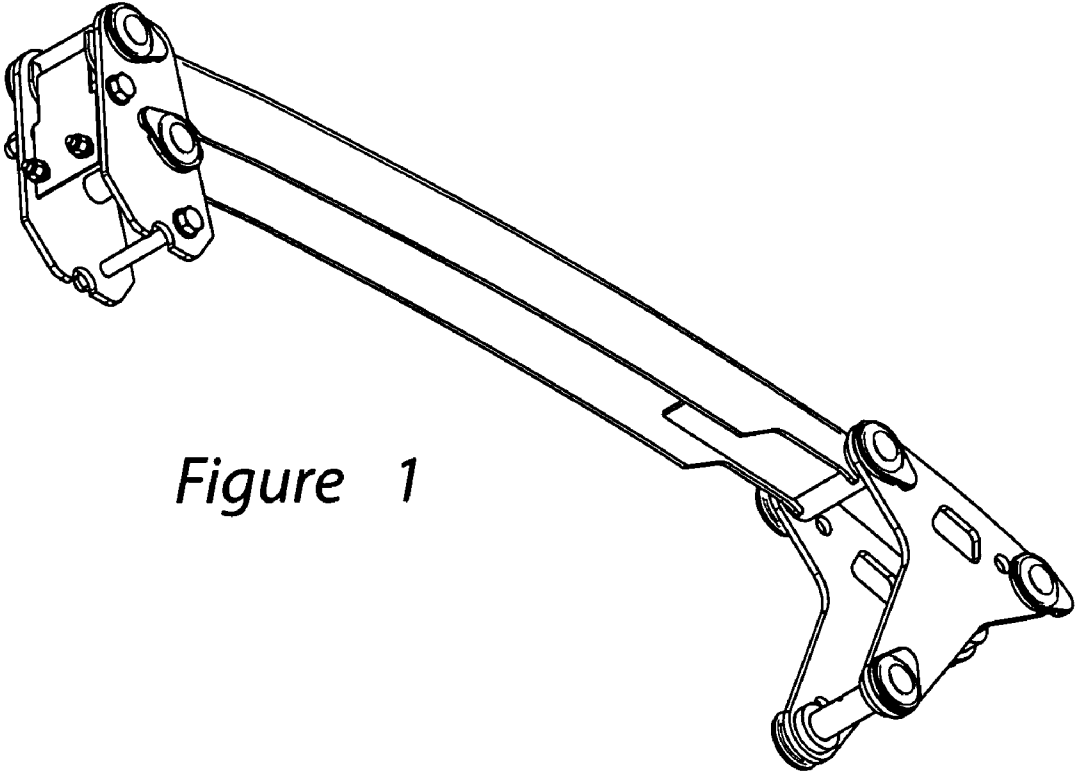

Figure 1

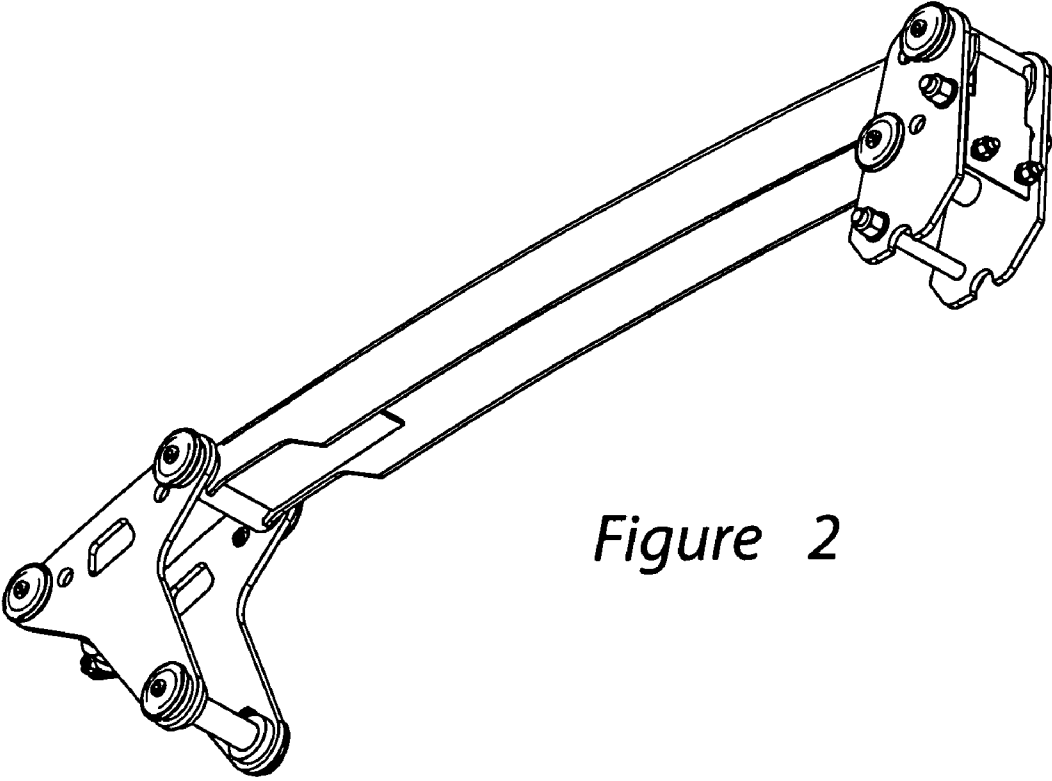

Figure 2

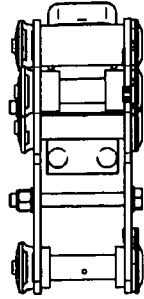

Figure 3

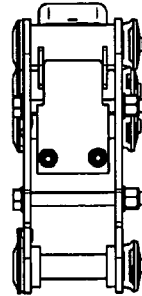

Figure 4

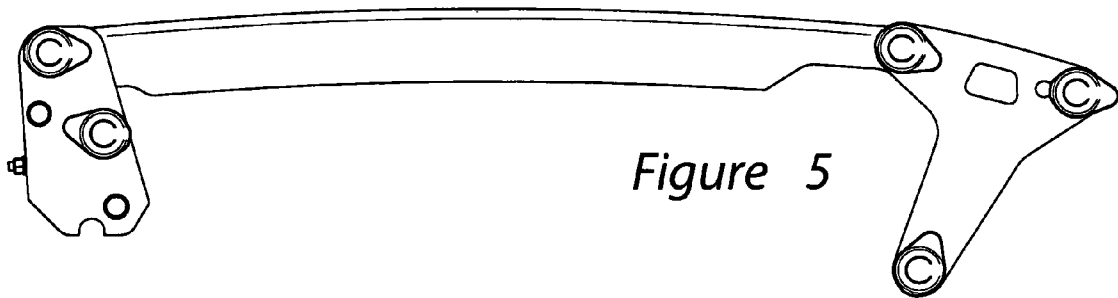

Figure 5

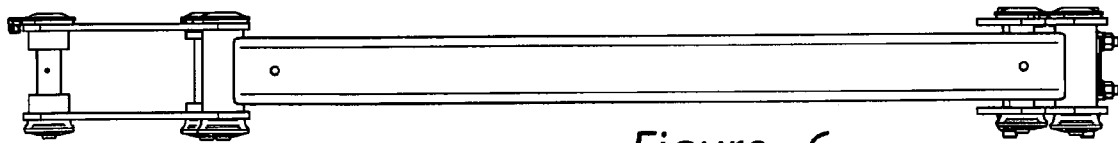

Figure 6

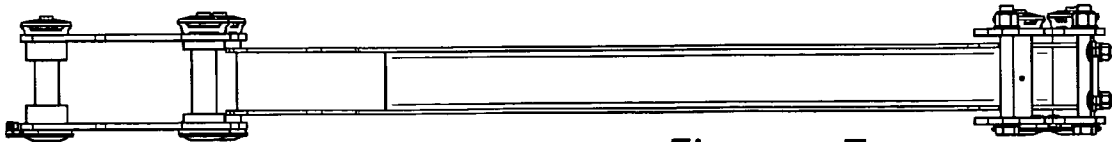

Figure 7