



US00D671950S

(12) **United States Design Patent**  
**Richter**

(10) **Patent No.:** **US D671,950 S**

(45) **Date of Patent:** **\*\* Dec. 4, 2012**

(54) **APPARATUS HOLDER**

(76) Inventor: **Harald Richter**, Engelbrand (DE)

(\*\*) Term: **14 Years**

(21) Appl. No.: **29/428,583**

(22) Filed: **Aug. 1, 2012**

(51) **LOC (9) Cl.** ..... **08-07**

(52) **U.S. Cl.** ..... **D14/447**

(58) **Field of Classification Search** ..... D14/447,  
D14/432, 434, 433, 439, 440, 448, 451, 452,  
D14/457, 460, 217, 239, 238.1, 250, 251,  
D14/253, 203.8, 341, 336, 371, 372, 374,  
D14/375, 376, 377, 378, 379, 392; D13/107,  
D13/108; D3/218; D6/406.1, 406.3, 406.4,  
D6/406.5, 406.6, 419, 420, 429, 396, 449,  
D6/466, 467, 471; 361/679.02, 679.09, 679.19,  
361/679.21, 679.22, 679.23, 679.26, 679.27,  
361/679.3, 679.55, 679.56, 679.6; 248/917-924,  
248/136, 150, 152, 153, 371, 166, 176.1,  
248/176.3, 188.6, 676, 678, 441.1, 444.1,  
248/447, 447.1, 447.2, 451, 454, 455, 456,  
248/460, 463, 465.1

See application file for complete search history.

(56) **References Cited**

**U.S. PATENT DOCUMENTS**

D603,840 S *	11/2009	Lee et al.	.....	D14/217
D610,587 S *	2/2010	Bandringa	.....	D14/447
D614,613 S *	4/2010	Kim et al.	.....	D14/253
D634,315 S *	3/2011	Nousiainen	.....	D14/253
D636,397 S *	4/2011	Green	.....	D14/447
D640,707 S *	6/2011	Yeh	.....	D14/447
D646,315 S *	10/2011	Orf	.....	D16/242
D650,372 S *	12/2011	Molter	.....	D14/239

D650,783 S *	12/2011	Ausfeld et al.	.....	D14/434
D653,668 S *	2/2012	Song et al.	.....	D14/447
D666,205 S *	8/2012	Li et al.	.....	D14/452
2011/0019992 A1 *	1/2011	Orf	.....	396/419
2012/0170212 A1 *	7/2012	Gallouzi et al.	.....	361/679.56

\* cited by examiner

*Primary Examiner* — Angela J Lee

(74) *Attorney, Agent, or Firm* — Klaus J. Bach

(57) **CLAIM**

The ornamental design for an apparatus holder, as shown and described.

**DESCRIPTION**

FIG. 1 is a perspective view of an apparatus holder; FIG. 2 is a front view of the apparatus holder shown in FIG. 1, FIG. 3 is a top end view of the apparatus holder shown in FIG. 2, FIG. 4 is a bottom end view of the apparatus holder shown in FIG. 2, FIG. 5 is a right end view of the apparatus holder shown in FIG. 2, FIG. 6 is a left end view of the apparatus holder shown in FIG. 2; and, FIG. 7 is a rear view of the apparatus holder as shown in FIG. 2.

The apparatus holder is used for supporting for example a smart phone on a support device. The lower arms are adjustably extendable and are lockable in the selected positions to accommodate the corners of the smart phone when used for example as a GPS in a horizontal position. The upper part is spring-biased inwardly to engage a side edge of the smart phone. At its rear the holder is provided with mounting means for attachment to the support device.

**1 Claim, 5 Drawing Sheets**

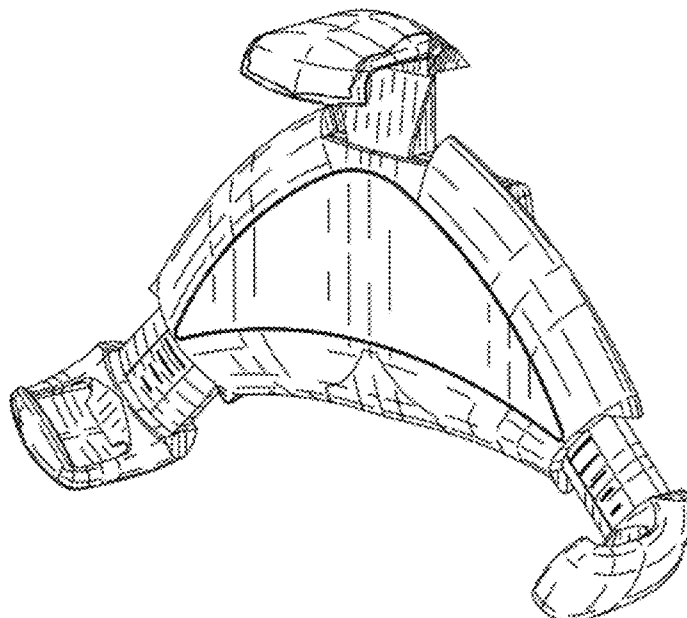

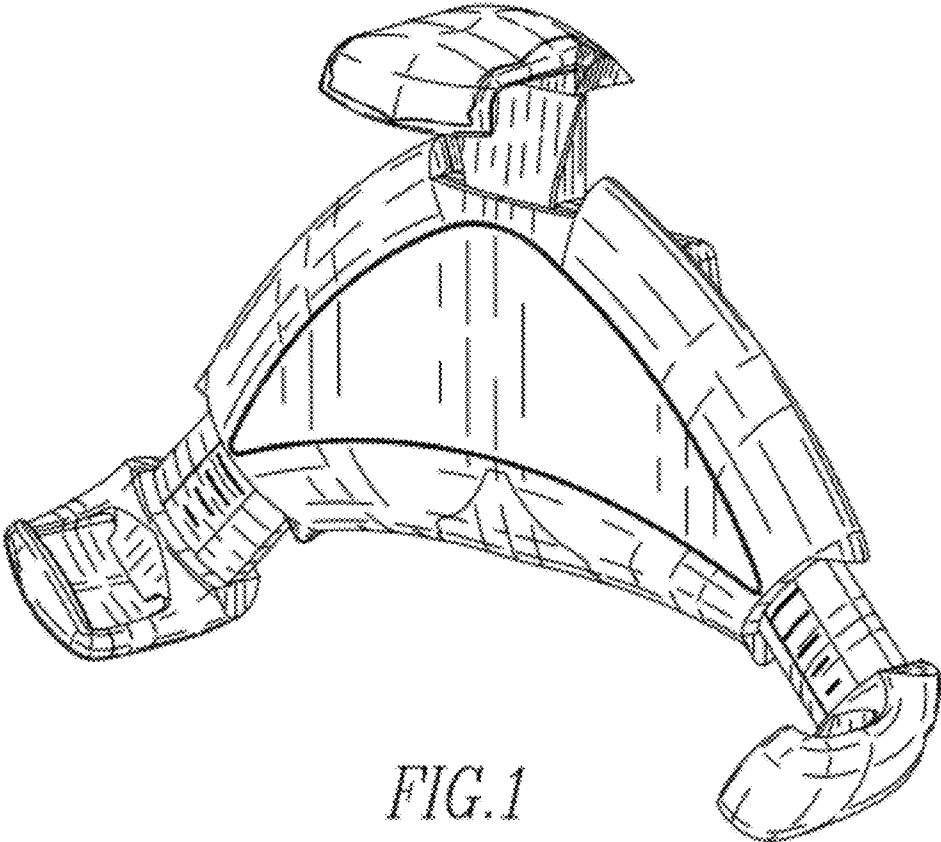

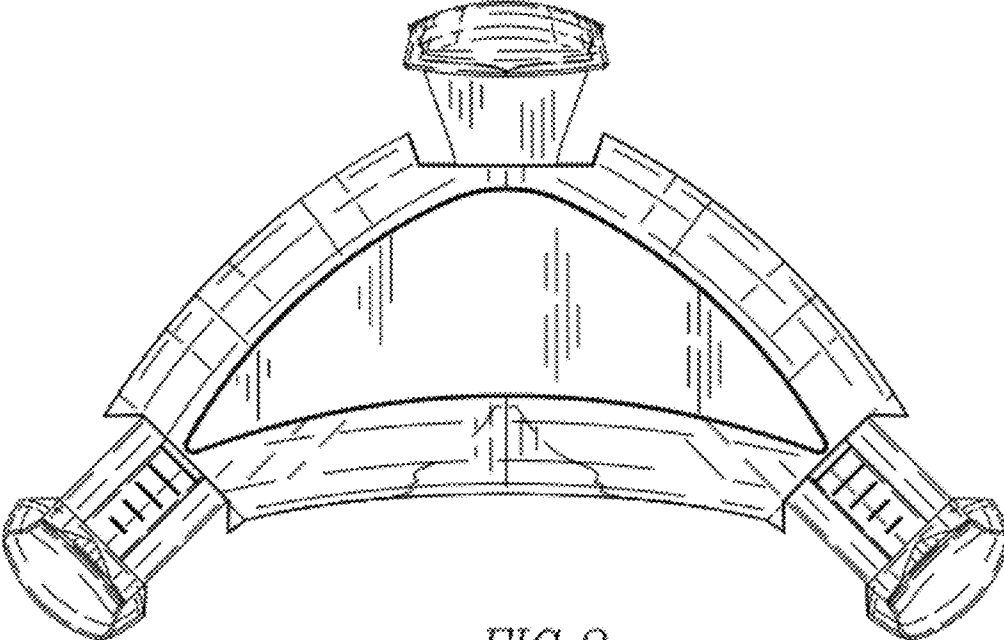

FIG. 2

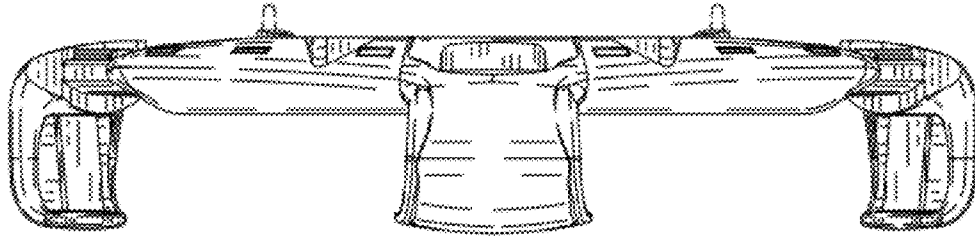

FIG. 3

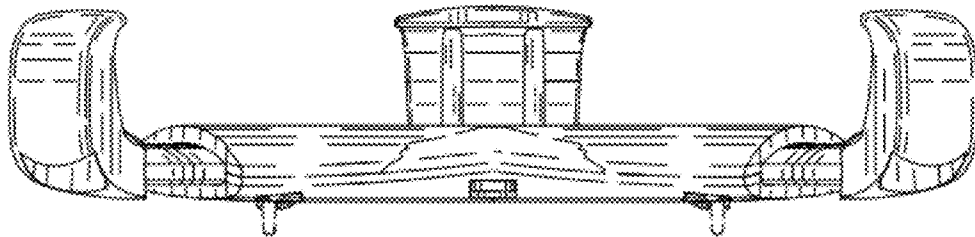

FIG. 4

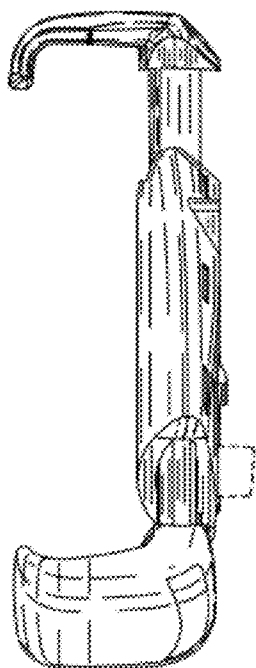

FIG. 5

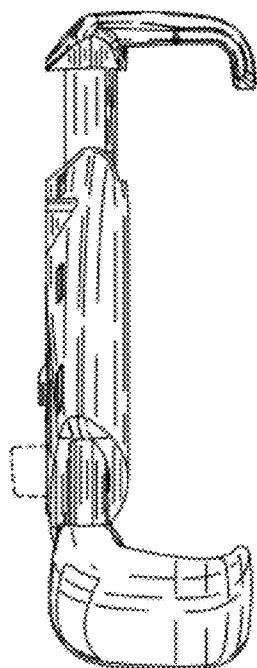

FIG. 6

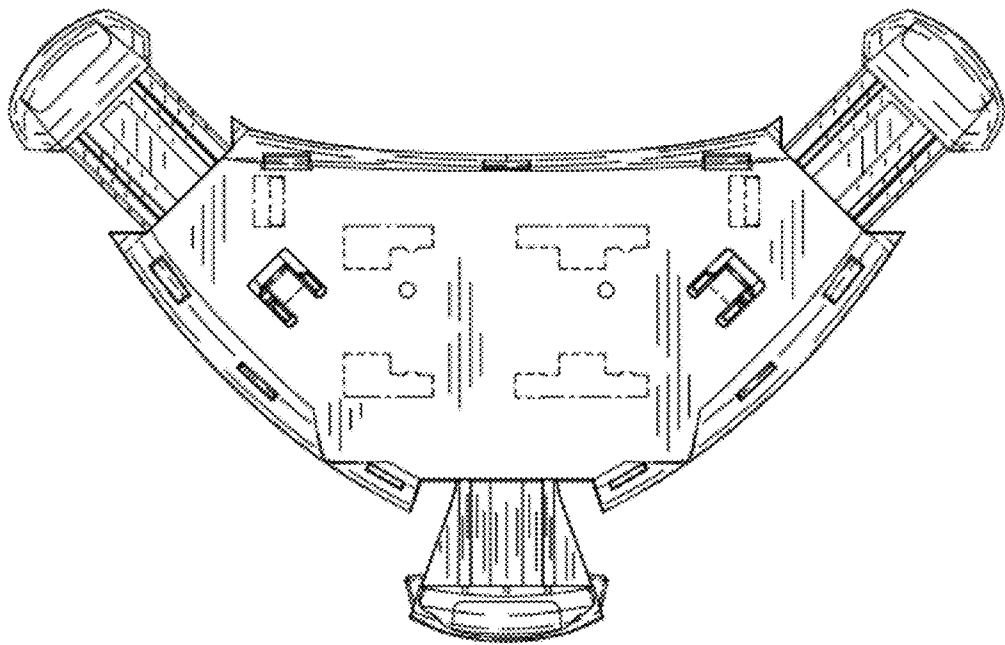

FIG. 7